

Installation Instructions

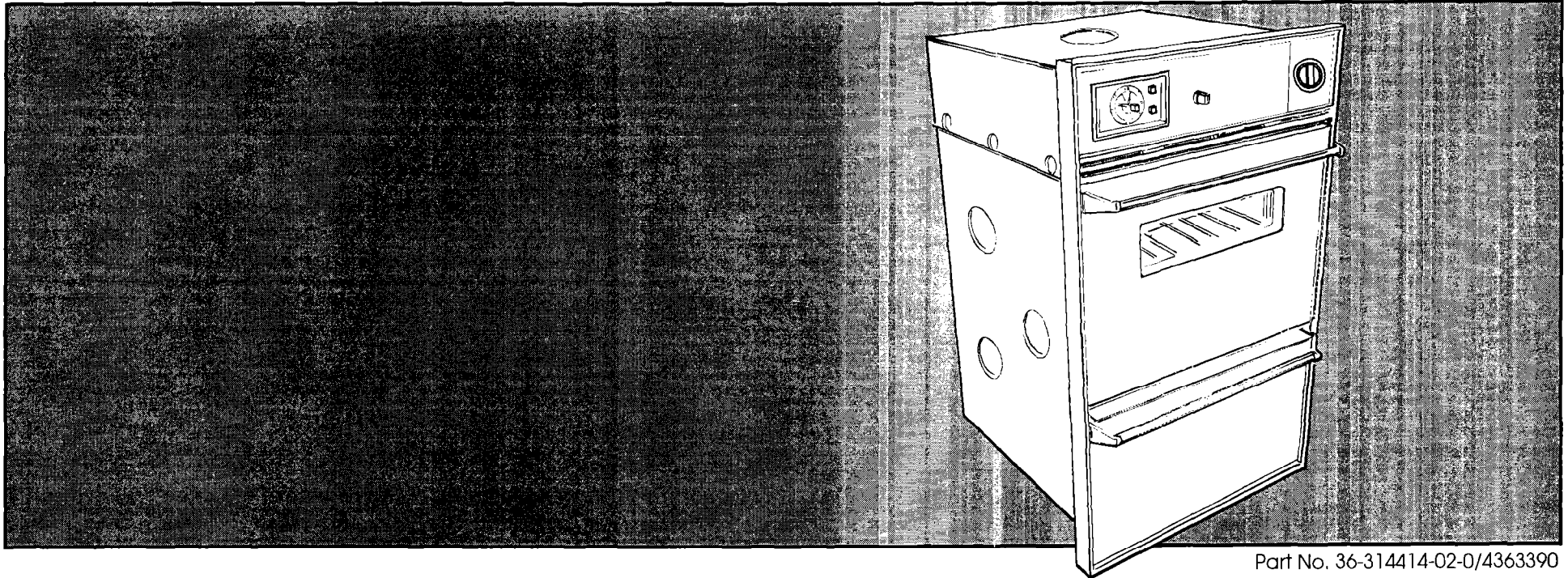

Part No. 36-314414-02-0/4363390

IMPORTANT:
Read and save
these instructions.

IMPORTANT:

Installer: Leave Installation Instructions with the homeowner.

Homeowner: Keep Installation Instructions for future reference.

Save Installation Instructions for local electrical inspector's use.

24" Gas
Built-in
Wall Oven
Blanket of Flame



10-95

Before you start...

Proper installation is your responsibility. Make sure you have everything necessary for correct installation. It is the responsibility of the installer to comply with the installation clearances specified on the serial/rating plate. The serial/rating plate can be found on the oven frame behind the oven door.

Check location where wall oven will be installed. The location should be away from strong draft areas, such as windows, doors, and strong heating vents or fans. The wall oven should be located for convenient use in the kitchen.

Cabinet opening dimensions that are shown must be used. Given dimensions provide 0" clearance. Dimensions given are for wall oven sitting on cabinet floor. Cabinet floor must be solid and level.

Important: Observe all governing codes and ordinances.

Failure to meet codes and ordinances could lead to fire or electrical shock hazard.

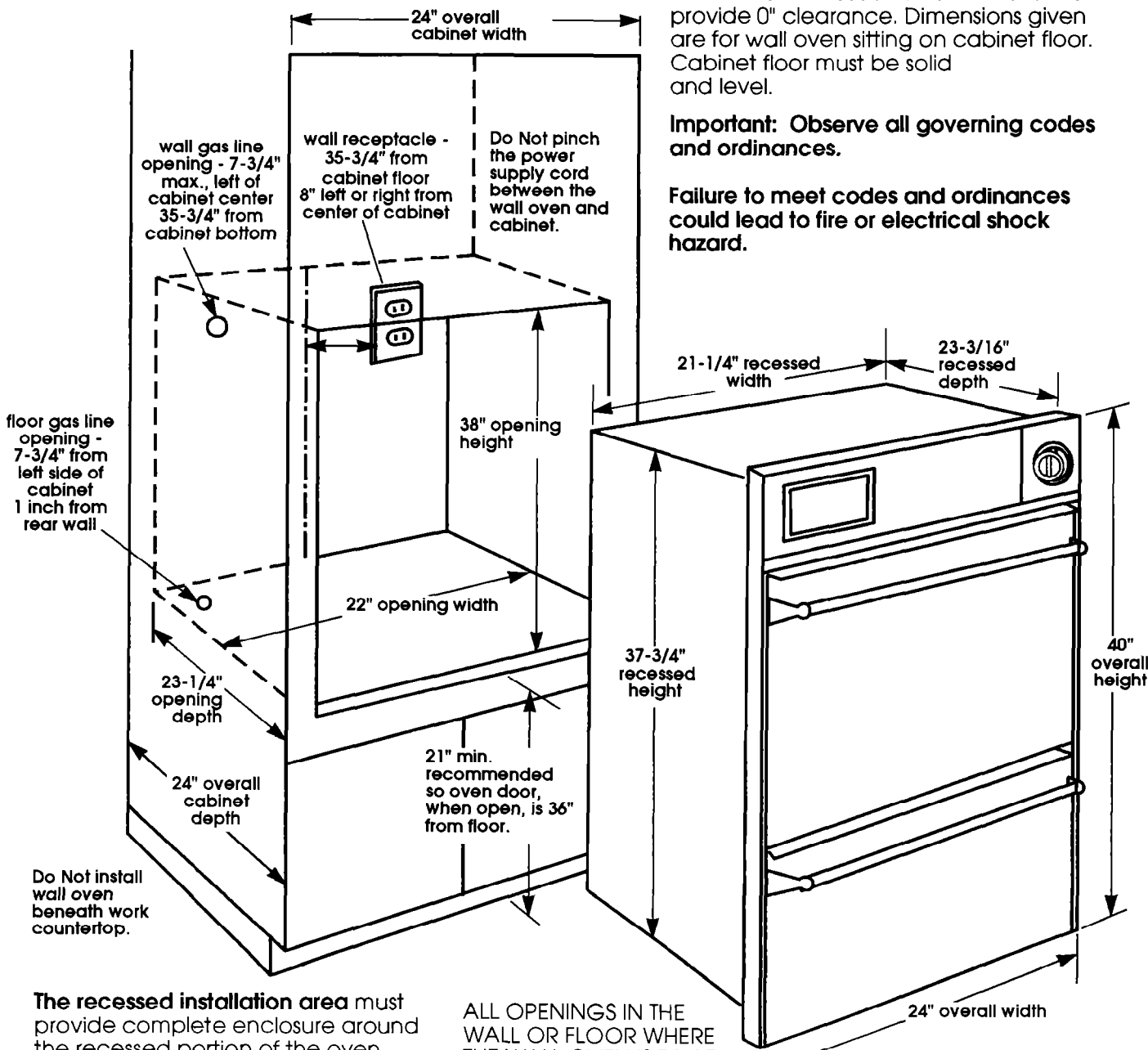

The recessed installation area must provide complete enclosure around the recessed portion of the oven.

Grounded electrical outlet is required. See "Electrical requirements," Panel B.

ALL OPENINGS IN THE WALL OR FLOOR WHERE THE WALL OVEN IS TO BE INSTALLED MUST BE SEALED.

Proper gas supply connection must be available. See "Gas supply requirements," Panels A and B.

WARNING: If the information in this manual is not followed exactly, a fire or explosion may result causing property damage, personal injury or death.

- Do Not store or use gasoline or other flammable vapors and liquids in the vicinity of this or any other appliance.
- **WHAT TO DO IF YOU SMELL GAS**
 - Do Not try to light any appliance.
 - Do Not touch any electrical switch; Do Not use any phone in your building.
 - Immediately call your gas supplier from a neighbor's phone. Follow the gas supplier's instructions.
 - If you cannot reach your gas supplier, call the fire department.
- Installation and service must be performed by a qualified installer, service agency or the gas supplier.

B. Input ratings shown on the serial/rating plate are for elevations up to 2,000 feet. For elevations above 2,000 feet, ratings are reduced at a rate of 4% for each 1,000 feet above sea level.

WARNING

Fire Hazard

Do Not obstruct the flow of combustion and ventilation air.

Electrical Shock Hazard

It is the customer's responsibility:

- To contact a qualified electrical installer.
- To assure that electrical installation is adequate and in conformance with National Electrical Code, ANSI/NFPA 70 — latest edition*, and all local codes and ordinances.

Failure to do so could result in fire, electrical shock or other personal injury.

Tools needed for installation:

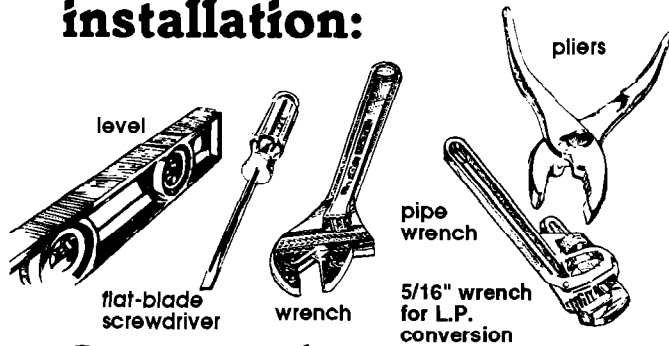

Gas supply requirements

Observe all governing codes and ordinances.

C. This wall oven is equipped for use with NATURAL gas. It is design-certified by A.G.A. for NATURAL and L.P. gases with appropriate conversion.

The serial/rating plate located on the oven frame behind the oven door has information on the type of gas that can be used. If this information does not agree with the type of gas available, check with the local gas supplier. See Panel E for L.P. gas conversion instructions.

Mobile Home Installation

The installation of this wall oven must conform to the Manufactured Home Construction and Safety Standards, Title 24 CFR, Part 3280 (formerly the Federal Standard for Mobile Construction and Safety, Title 24, HUD Part 280); or when such standard is not applicable, the Standard for Manufactured Home Installation 1982 (Manufactured Home Sites, Communities and Setups), ANSI A225.1/NFPA 501A, or with local codes.

Copies of the standards listed may be obtained from:

* National Fire Protection Association
Batterymarch Park
Quincy, Massachusetts 02269

** American Gas Association
1515 Wilson Boulevard
Arlington, Virginia 22209

WARNING

Fire Hazard

- Oven must be connected to a regulated gas supply.
- L.P. gas supply must Not exceed a pressure of 14-inch water column. This must be checked by a qualified technician before installing this oven.
- Do Not use an open flame to test for leaks from gas connections.
- New, A.G.A. designed-certified flexible gas line should be used when codes permit.

Failure to follow these instructions could result in a fire, explosion or personal injury.

A. This installation must conform with local codes and ordinances. In the absence of local codes, installation must conform with American National Standard, National Fuel Gas Code ANSI Z223.1 — latest edition.**

D. Provide a gas supply line of 3/4" rigid pipe to the wall oven location either through the wall or cabinet floor. A smaller size pipe on long runs may result in insufficient gas supply. Keep pipe near the wall. The wall oven gas fitting is located at upper right side of appliance. Pipe-joint compounds made for use with L.P. gas must be used. With L.P. gas, piping or tubing size can be 1/2" minimum. L.P. gas suppliers usually determine the size and materials used on their system.



E. If local codes permit, A.G.A. design-certified, new flexible metal tubing is recommended for connecting this wall oven to the gas supply line. Do Not kink or damage the flexible tubing when moving the wall oven. A 1/2" male pipe thread is needed for connection to pressure regulator female pipe threads.

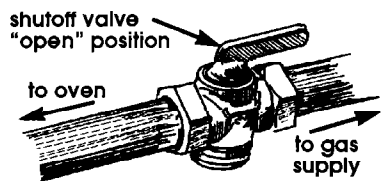

F. The supply line shall be equipped with a shutoff valve. This valve should be located in the same room as the wall oven and should be in a location that allows ease of opening and closing. Do Not block access to shutoff valve. This wall oven is equipped with an oven burner shutoff valve located on the wall oven manifold.

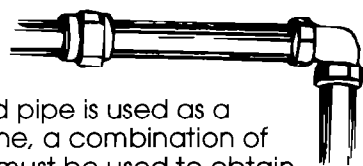

G. If rigid pipe is used as a gas supply line, a combination of pipe fittings must be used to obtain an in-line connection to the wall oven. All strains must be removed from the supply and fuel lines so wall oven will be level and in line.

H. The regulator must be checked at a minimum of 1-inch water column above the manifold pressure. The inlet pressure to the regulator should be as follows for operation:

NATURAL GAS:

- Minimum pressure — 6 inches
- Maximum pressure — 14 inches

L.P. GAS:

- Minimum pressure — 11 inches
- Maximum pressure — 14 inches

I. Line pressure testing:

Testing above 1/2 psi (gauge)

The oven and its individual shutoff valve must be disconnected from the gas supply piping system during any pressure testing of that system at test pressures greater than 1/2 psig (3.5 kPa).

Testing at 1/2 psi (gauge)

The oven must be isolated from the gas supply piping system by closing its individual manual shutoff valve during any pressure testing of the gas supply piping system at test pressures equal to or less than 1/2 psig (3.5 kPa).

Electrical requirements

! WARNING

Electrical Shock Hazard

- **Electrical ground is required on this appliance.**
- **Do Not ground to a gas pipe.**
- **Do Not modify the power supply cord plug. If it does not fit the outlet, have a proper outlet installed by a qualified electrician.**
- **Do Not have a fuse in the neutral or grounding circuit. A fuse in the neutral or grounding circuit could result in an electrical shock.**
- **Do Not use an extension cord with this appliance.**
- **Check with a qualified electrician if you are in doubt as to whether the appliance is properly grounded.**

Failure to follow these instructions

If codes permit and a separate grounding wire is used, it is recommended that a qualified electrician determine that the grounding path is adequate.

A 120-volt, 60-Hz, AC-only, 15-ampere fused electrical supply is required. A time-delay fuse or circuit breaker is recommended. It is recommended that a separate circuit serving only this appliance be provided.

A wiring diagram is included in the literature package. The wiring diagram is also located behind the control panel.

Recommended grounding method

For your personal safety, this appliance must be grounded. This appliance is equipped with a power supply cord having a 3-prong grounding plug. To minimize possible shock hazard, the cord must be plugged into a mating 3-prong grounding-type wall receptacle, grounded in accordance with the National Electrical Code, ANSI/NFPA 70 — latest edition(*, see Panel A) and all local codes and ordinances. See Figure 1. If a mating wall receptacle is not available, it is the personal responsibility and obligation of the customer to have a properly grounded 3-prong wall receptacle installed by a qualified electrician.

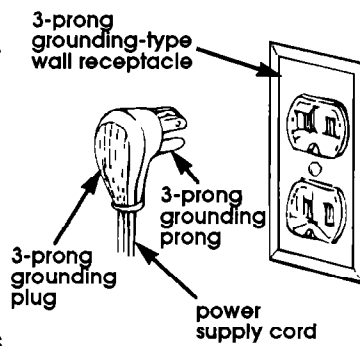
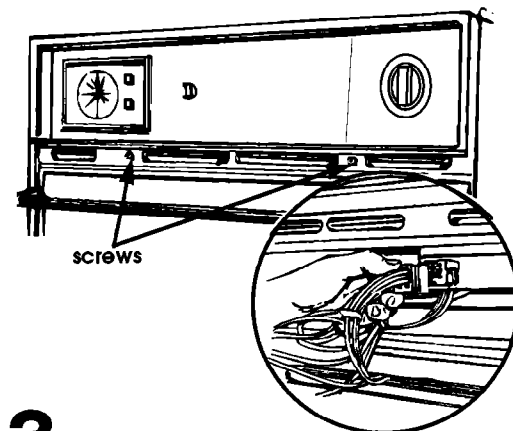

Figure 1

Now start... With wall oven in kitchen.

- 1.** Remove racks and other parts from inside oven.
- 2.** Remove shipping materials, tape and protective film from wall oven. Do Not remove cardboard shipping base at this time.



- 3.** Remove the oven control knob. Remove the 2 screws that attach the control panel to the oven frame. Move the control panel down and forward. Disconnect the plug from the terminal block. Carefully place control panel, screws and oven control knob in a safe location.

! WARNING

**Personal Injury/
Product Damage Hazard**

- **Use both hands to remove oven door.**
- **Grasp only the sides of the oven door.**
- **Do Not use handle or any portion of the front frame or trim for lifting.**
- **Because of the weight and size of the oven, two or more people are needed to move and safely install oven.**

Failure to properly grasp the oven door or to lift oven properly could result in personal injury or damage to product.

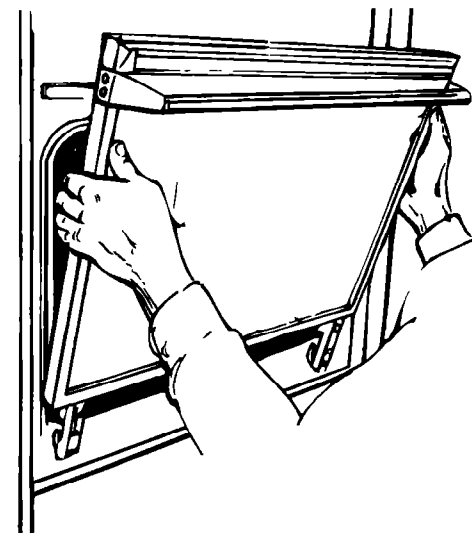

- 4.** Open oven door to first stop position. Grasp the sides of the oven door and pull the door up and off the hinges to remove. Set door aside on a protected surface.

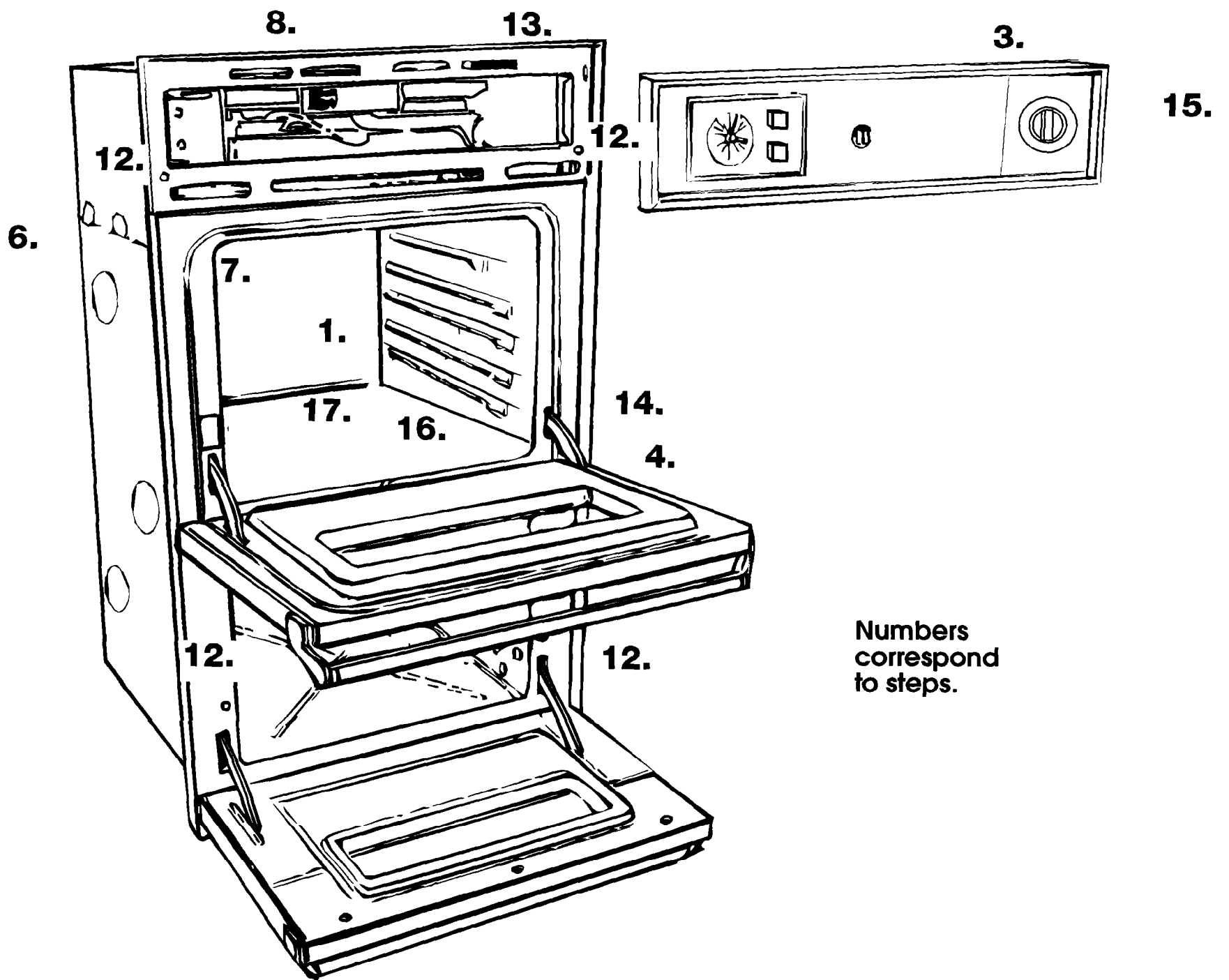

Numbers correspond to steps.

! WARNING

Fire Hazard

Do Not make connection too tight. The regulator is die cast.

Overtightening may crack the regulator, resulting in a gas leak and possible fire or explosion.

All connections must be wrench-tightened.

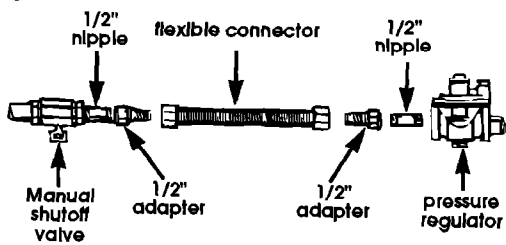

5. Assemble the flexible connector from the gas supply pipe in this order: manual shutoff valve, 1/2" nipple, 1/2" adapter, flexible connector, 1/2" adapter and 1/2" nipple.

! CAUTION

Floor Damage

Before moving oven across floor, check that oven is on shipping base or slide oven onto cardboard or hardboard.

Failure to follow these instructions may result in damage to floor covering.

6. Turn power supply off. Move oven close to final position. Remove and discard shipping base, cardboard or hardboard. Thread flexible connector through back of wall oven. Plug the power supply cord into the grounded outlet. See "Electrical requirements," Panel B.

! CAUTION

Product Damage

Carefully push against the seal area on the oven front frame when pushing oven into cabinet. Do Not push against outside edges.

Failure to follow this instruction can result in damage to porcelain finish.

7. Lift oven up into cabinet cutout, using the oven opening as an area to grip.

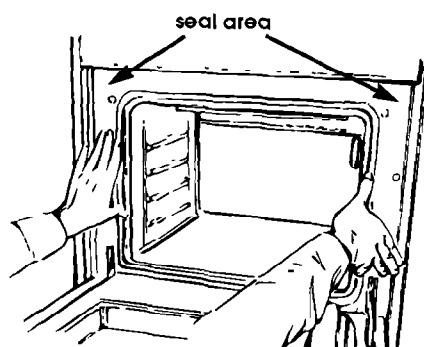
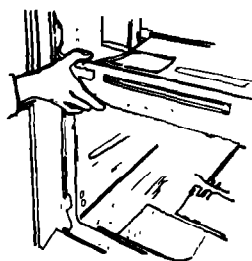

Push against seal area of front frame to push oven into cabinet.

Check that spacers behind front frame are tight against the front of the cabinet. Do Not recess the spacers. The small gap provided by spacers allows air flow for cooling the cabinet.

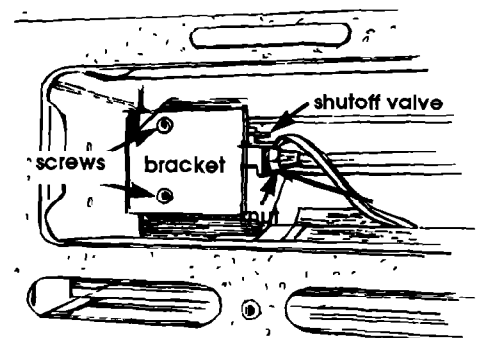
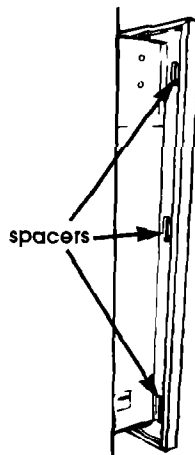

8. Disconnect shutoff valve by removing the flared nut. Remove two screws that attach the manifold pipe and regulator to the mounting bracket. Move regulator slightly and attach flexible connector to pressure regulator. Reconnect manifold pipe to mounting bracket. Reconnect shutoff valve.

9. Use pipe-joint compound made for use with L.P. gas to seal all gas connections. Check that the oven shutoff valve is open between the regulator and gas valves. If flexible connectors are used, be certain connectors are not kinked.

10. Open the shutoff valve in the gas supply line. Wait a few minutes for gas to move through the gas line.



WARNING

Fire Hazard

Do Not use an open flame to test for leaks from gas connections. Checking for leaks with a flame may result in a fire or explosion.

11. Use a brush and liquid detergent to test all gas connections for leaks. Bubbles around connections will indicate a leak. If a leak appears, shut off gas valve controls and adjust connections. Then check connections again. **NEVER TEST FOR GAS LEAKS WITH A MATCH OR OTHER FLAME.** Clean all detergent solution from wall oven.



WARNING

Personal Injury/ Product Damage Hazard

Securely fasten oven to cabinet using the four screws provided. Failure to do so could cause the oven to move or tip during use and result in personal injury or product damage.

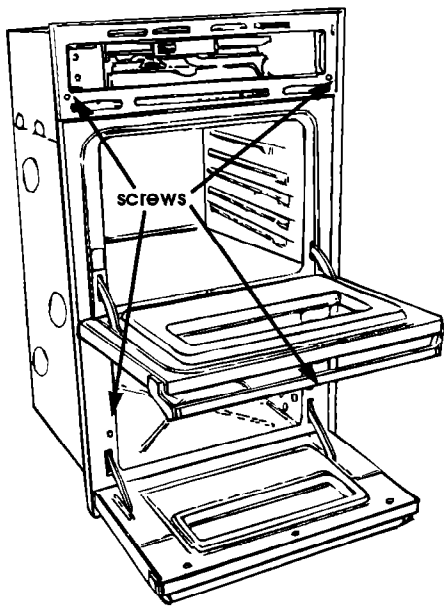

12. Center oven in cabinet cutout. Use four screws through the mounting holes in the front frame of the oven to secure oven to cabinet. Do Not overtighten screws.

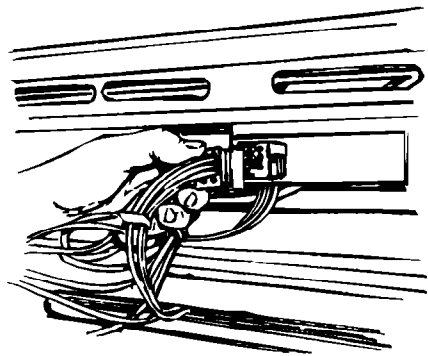

13. Reconnect wire plug to control terminal block. Replace the control panel and oven control knob.

14. Replace oven door by partially fitting door hinges into the hinge slots. Pull door slightly towards you, then slide door completely into place. If door does not close, you have not pushed hinges completely into frame.

15. Turn power supply on.



CAUTION

Product Damage

Do Not insert any object into the openings of the protective shield that surrounds the ignitor. Do Not clean the area. Failure to follow these instructions could result in product damage.

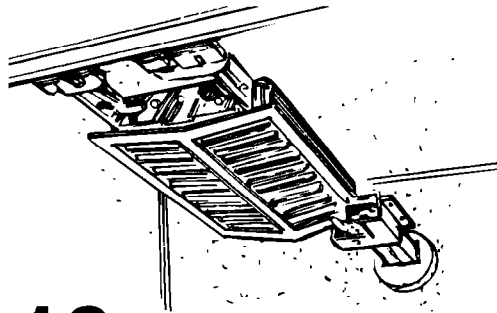

16. Push in and turn the oven selector knob to "BROIL". The burner should light in 50 - 60 seconds. This delay is normal. The oven safety valve requires a certain time before it will open and allow gas to flow.

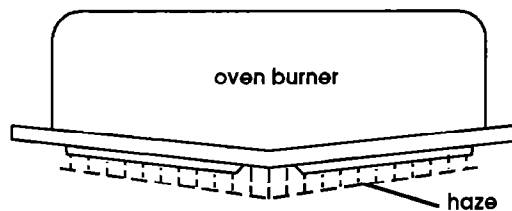

The hazy appearance of the flame is normal for this type of infrared burner. The burner cannot be adjusted.

17. Replace oven bottom and oven racks.

You have just finished installing your new Whirlpool wall oven. To get the most efficient use from your new gas wall oven, read your **Congratulations!**

Whirlpool Use and Care Guide. Keep Installation Instructions and Guide close to wall oven for easy reference. The instructions will make reinstalling your Whirlpool wall oven in another home as easy as the first installation.

L.P. gas conversion

Converting to L.P. gas should be done by a qualified installer.

WARNING

Fire Hazard

- Locate gas supply valve between pressure regulator and gas valve. Shut off gas supply valve to oven before converting to L.P. gas.
 - Make burner conversions before turning the oven gas supply back on.
- Failure to follow these instructions could result in a fire, explosion or personal injury.

A. Complete installation Steps 1-9 before converting your oven to L.P. gas. Remove oven racks and oven bottom. Shut off gas supply valve to oven.

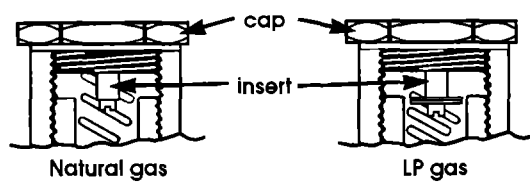

B. Pressure regulator: Remove the cap with the screwdriver slot. Remove the insert, marked "NAT", from the cap. (Insert fits tightly into cap.) Reverse insert so "LP" shows and carefully push insert into cap until insert shoulder stops it. Use care not to disturb the spring in the body of the regulator. Replace the cap in the body of the regulator and tighten.

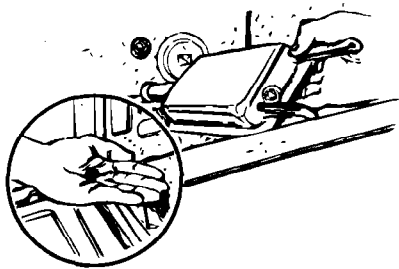

C. Burner: Remove the burner by pressing in on front of burner until retainer clips loosen. Gently pull burner out and down. Care must be taken not to break the ignitor coil.

Carefully set burner aside with screen side up.

Use a 5/6-inch wrench to remove the Natural gas burner orifice spud. Save the Natural gas orifice spud for future use.

Remove cover at the top left side of oven. Remove the L.P. gas burner orifice spud wired to the inlet pipe.

Wire the Natural gas burner orifice spud to the inlet pipe at the top left side of oven. Close cover.

Install the L.P. gas burner orifice spud. Replace the burner so the screen louvers face down and to the rear of oven.

E. Complete installation Steps 10-15.

Adjusting for proper flame

CAUTION

Product Damage

- Electric ignitors are used to light the oven and broil burners. Do Not insert any object into the openings of the shield surrounding the ignitor coil.
- Do Not clean this area.

Failure to follow these instructions could result in product damage.

After burner has been converted. Complete Steps 16-17, Panels C and D.

Panel E

Natural gas conversion

Converting to Natural gas should be done by a qualified installer.

WARNING

Fire Hazard

- Locate gas supply valve between pressure regulator and gas valve. Shut off gas supply valve to oven before converting to Natural gas.
 - Make all oven and broil burner conversions before turning the oven gas supply back on.
- Failure to follow these instructions could result in a fire, explosion or personal injury.

A. Shut off gas supply valve to oven. Remove oven racks and oven bottom.

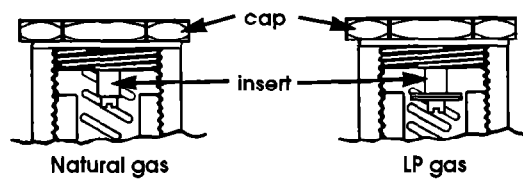

B. Pressure regulator: Remove the cap with the screwdriver slot. Remove the insert, marked "LP", from the cap. (Insert fits tightly into cap.) Reverse insert so "Nat" shows and carefully push insert into cap until insert's shoulder stops it. Use care not to disturb the spring in the body of the regulator. Replace the cap in the body of the regulator and tighten.

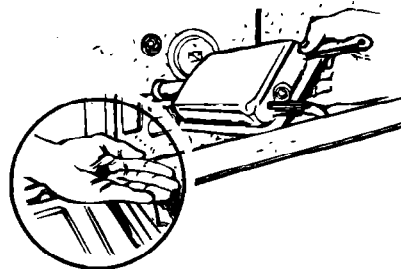

C. Burner: Remove the broil burner by pressing in on front of burner until retainer clips loosen. Gently pull burner out and down. Care must be taken not to break the ignitor coil.

Carefully set burner aside with screen side up.

Use a 5/6-inch wrench to remove the L.P. gas burner orifice spud. Save the L.P. gas orifice spud for future use.

Remove cover at the top left side of oven. Remove the Natural gas burner orifice spud wired to the inlet pipe.

Wire the L.P. gas burner orifice spud to the inlet pipe at the top left side of oven. Close cover.

Install the Natural gas burner orifice spud. Replace the burner so the screen louvers face down and to the rear of oven.

Adjusting for proper flame

CAUTION

Product Damage

- Electric ignitors are used to light the oven and broil burners. Do Not insert any object into the openings of the shield surrounding the ignitor coil.
- Do Not clean this area.

Failure to follow these instructions could result in product damage.

After burner has been converted, turn the oven gas supply valve back on. Complete Steps 16-17, Panel D.

If oven does not operate...

- Check that the circuit breaker is not tripped or the house fuse blown.
- Check that the power supply cord is plugged into the wall receptacle.

If you need assistance...

The Whirlpool Consumer Assistance Center will answer any questions about operating or maintaining your oven not covered in the Installation Instructions. The Whirlpool Consumer Assistance Center number is 1-(800) 253-1301. Dial just as you normally dial long distance — the call is free.

When you call, you will need the oven model and serial number. Both numbers can be found on the serial/rating plate behind the oven door on the front frame.

If you need service...

In the event your Whirlpool appliance should ever need service, call the dealer from whom you purchased the appliance or a Whirlpool-authorized service company. The dealer or service company is listed in the Yellow Pages of your phone directory under "Appliances — Household — Major — Service and Repair." You can also obtain the name and number by dialing, free within the continental United States, the Whirlpool Consumer Assistance Center number — 1-(800) 253-1301. A special operator will tell you the name and number of your nearest Whirlpool-authorized service company. Maintain the quality built into your Whirlpool appliance — call a Whirlpool-authorized service company.

