

Installation Instructions

READ BEFORE INSTALLING UNIT For Through-the-Wall Air Conditioners

INSTALLATION WARNINGS AND CAUTION

- * Carefully read the installation manual before beginning.
 - * Follow each step as shown.
 - * Observe all local, state, and national electrical codes and by qualified, licensed, authorized personnel only.
 - * Pay attention to danger and safety notices.
- To avoid risk of personal injury, property damage, or product damage due to the weight of this device and sharp edges that may be exposed:
- * Air conditioners covered in this manual pose an excessive weight hazard. Two or more people are needed to move and install the unit. Wear protective gloves whenever lifting or carrying the unit. AVOID the sharp metal fins of front and rear coils. To prevent injury or strain, use proper lifting and carrying techniques when moving unit.
 - * Carefully inspect location where air conditioner will be installed. Be sure it will support the weight of the unit over an extended period of time.
 - * Handle air conditioner with care.
 - * Make sure air conditioner does not fall during installation.

Do This First (for existing sleeve)

Note that the air conditioner dimensions are: 24" wide, 14" high, and 19" deep (without front). Install Air Conditioner according to these installation instructions to achieve the best performance. Save these installation instructions for future reference.

NOTE:

- DO NOT USE ANY SCREWS OTHER THAN THOSE SPECIFIED HERE

Items in Kit

You may not need all parts in the kit. Discard unused parts.

No.	Hardware	Qty.	No.	Hardware	Qty.
1	Tapered Spacer Blocks (17" Long)	2	10	Trim Frame (side legs)	2
2	Centering/Support Blocks (4 1/2" x 3 1/2" x 1 1/2")	4	11	Trim Frame (top & bottom legs)	2
3	Plastic Divider (1/8" x 4 1/2" x 14 1/2")	2	12	Ground Wire (green)	1
4	Stuffer Seal (1" x 1 1/2" x 84")	1	13	Toothed washer for grounding screw	2
5	seal (1" x 1 1/2" x 25")	3	14	Grounding Screw	1
6	seal (1" x 1 1/2" x 14")	2	15	Grille (plastic)	1
7	seal (1" x 3/8" x 25")	3	16	Grille Aluminum	1
8	seal (1" x 3/8" x 14")	2	17	Nuts (plastic)	4
9	seal (1" x 3/4" x 14")	2	18	Screw w/washer	4

2020213A0734

Installation Instructions

How to Install

1. Identify the wall-sleeve brand for your installation, from the chart below.

Brand	Wall Sleeve Dimensions		
	Width	Height	Depth
White-Westinghouse	25½	15¼	16, 17½ or 22
Frigidaire	25½	15¼	16, 17½ or 22
Carrier (52F Series)	25½	15¼	16, 17½ or 22
General Electric/Hotpoint	26	15⅝	15⅞
Whirlpool	25⅞	16½	17⅞ or 23
Fedders/Emerson*	27	16¾	16¾ or 19¾
Sears/Kenmore	25¾	16⅞	18⅝
Emerson/Fedders*	26¾	15¾	15
Carrier (51S Series)	25¾	16⅞	18⅝
Friedrich*	27	16¾	16¾

* For larger sleeves, an adaptor trim kit (EA120T) is available.

→ IMPORTANT

- All wall sleeves used to mount the new Air Conditioner must be in sound structural condition and have a rear grille that securely attaches to sleeve, or rear flange that serves as a stop for the Air Conditioner.
- For new installations, a Frigidaire Sleeve Kit (EA108T) is recommended.

⚠ CAUTION:

- When installation is complete, replacement unit MUST have a rearward slope as shown in Fig.1.

2. Remove old Air Conditioner from wall sleeve and prepare wall sleeve as follows:

- * Clean interior (do not disturb seals).
- * Wall sleeve must be securely fastened in wall before installing Air Conditioner. Drive more nails or screws through sleeve, into wall, if needed.
- * Retouch wall sleeve painted surface if needed.

3. If not existing, drill a 3/16" clearance hole for grounding screw through left side of wall sleeve, in a clear area about 3 inches maximum back from front edge of sleeve, using grounding screw and toothed washer. Pull loose end of ground wire out front of sleeve, and temporarily bend it down and around lower edge of sleeve (Fig.2). This ground wire will later be attached to frame of air conditioner once it is installed.

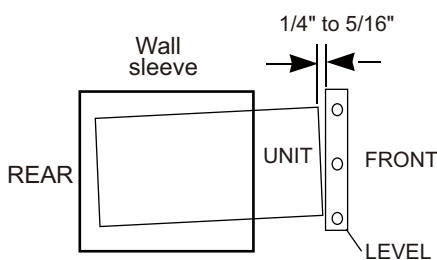

Fig.1

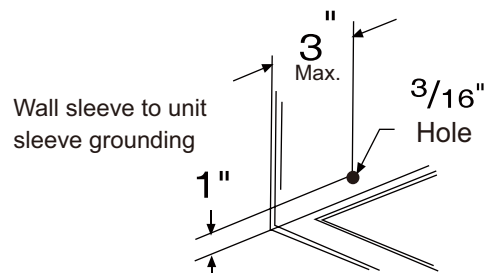

Fig.2

Installation Instructions

4. Prepare the wall sleeve for installation of the new unit per the following Brand instructions.

#1 Emerson	15" Deep
#2 Fedders	19 $\frac{3}{4}$ " Deep
#3 Fedders or Friedrich	16 $\frac{3}{4}$ " Deep
#4 General Electric/Hotpoint	16 $\frac{7}{8}$ " Deep
#5 Sears or Carrier(51S Series)	18 $\frac{5}{8}$ " Deep
#6 Whirlpool	17 $\frac{1}{8}$ " Deep
#7 Whirlpool	23" Deep
#8 White-Westinghouse/Frigidaire/ Carrier(52F Series)	16" + 17 $\frac{1}{2}$ " Deep
#9 White-Westinghouse/Frigidaire	22" Deep

5. Identify your wall sleeve type and follow the instructions for that type in the following pages.

IMPORTANT

- This unit's increased performance characteristics result from having two rear air intakes.
- It is very important that these installation instructions are followed so your unit can operate at maximum efficiency.
- If there is an existing sleeve, and there is an existing rear grille, it needs to be replaced by one that has been shipped with the unit in the accessory kit.

FOR INCREASED EFFICIENCY, UTILIZE THE PROVIDED LOUVERED REAR PANEL

Installation of new grille provided with unit

1. Remove the existing grille.
2. Place the grille included with the new air conditioner towards the rear of the sleeve.
3. Mark through the hole positions.
4. Drill through the sleeve flanges with a 1/8" drill bit.
5. Attach the new grille with self-threading screws and washers(not included).
6. It is VERY IMPORTANT that the grille is placed exactly as shown.
7. Most decorative exterior grilles may be left in place as long as the proper interior air direction grille is installed.



Installation Instructions

Wall Sleeve Brands:

#1 Emerson

15" Deep

1. Remove existing rear grille as shown on Page 3 of this manual and replace with provided louvered rear panel. Install as shown here.

NOTE: You may need to drill holes in flange of existing sleeve to match new rear grille

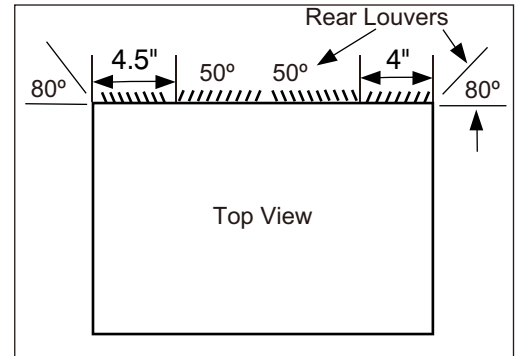

2. Attach (1) 1" x 3/8" x 25" long seal in the center at the top of the sleeve. Remove the backing paper and press into position.
3. Attach (2) 1" x 3/8" x 14" seals to the left and right sides of the sleeve.
4. Cut (2) 1" x 3/8" x 25" long seals to 14" long each and attach to the vertical sections of the grille as shown.
5. Attach (2) 4 1/2" x 3 1/2" x 1 1/2" centering/support blocks one on each side wall. Place in center of side wall with the tapered end facing the opening.
6. Gently slide unit into sleeve.
7. Before sliding all-the-way back, remove 2nd screw from front on left side of unit.
8. Remove the plastic washer from the screw.
9. Screw and attach the other end of the ground wire from sleeve to the unit as shown in picture. Make sure that the toothed washer is against the cabinet.
10. Slide the unit completely to the rear to ensure a good seal, making sure the ground wire does not become tangled.
11. Seal & Frame the unit as described on the last page of these instructions.
12. If you have difficulty with mounting the grill to the sleeve, follow the instructions for direct mounting on Page 13.

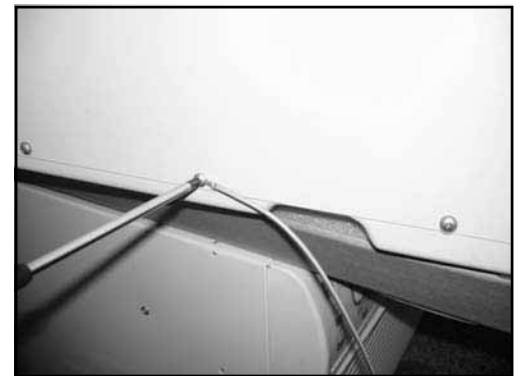
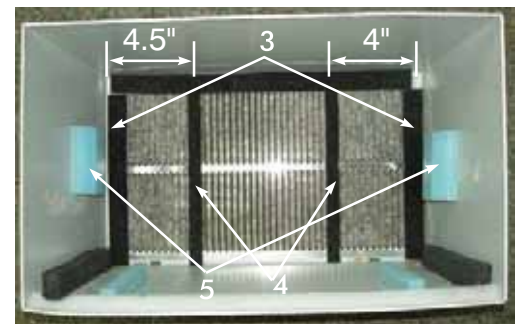

Installation Instructions

Wall Sleeve Brands:

#2 Fedders

19-3/4" Deep

1. Remove existing rear grille as shown on Page 3 of this manual and replace with provided louvered rear panel. Install as shown here.

NOTE: You may need to drill holes in flange of existing sleeve to match new rear grille

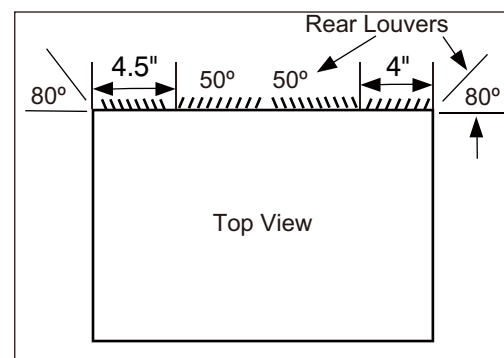

2. Attach (2) 4 1/2" x 3 1/2" x 1 1/2" centering/support blocks one on each side wall. Place in center of side wall with the tapered end facing the opening.

3. Cut (2) 17" Tapered Spacer Blocks as shown below into two pieces.

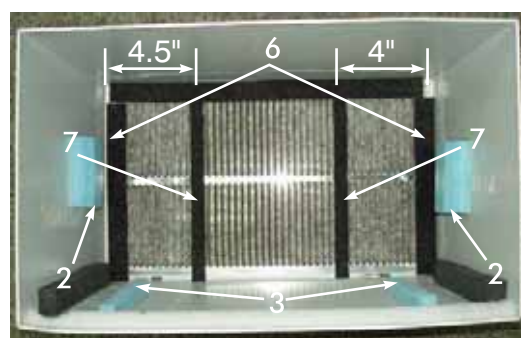
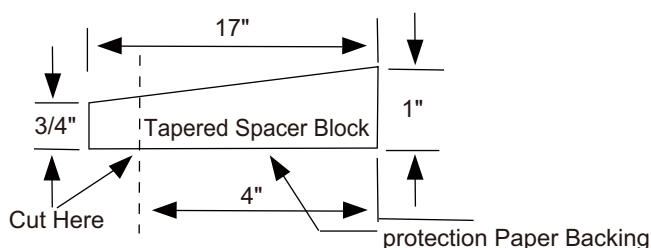

4. The 4" section is placed in front of the rib on base with the tapered end facing the back of the sleeve. The remaining portion will be placed behind the rib again sloping toward the rear of the sleeve. This helps induce a rearward slope on the unit.

5. Attach (1) 1" x 3/8" x 25" long seal in the center at the top of the sleeve. Remove the backing paper and press into position.

6. Attach (2) 1" x 3/8" x 14" seals to the left and right sides of the sleeve.

7. Cut (2) 1" x 3/8" x 25" long seals to 14" long each and attach to the vertical sections of the grille as shown.

8. Gently slide unit into sleeve.

9. Before sliding all-the-way back, remove 2nd screw from front on left side of unit.

10. Remove the plastic washer from the screw.

11. Screw and attach the other end of the ground wire from sleeve to the unit as shown in picture. Make sure that the toothed washer is against the cabinet.

12. Slide the unit completely to the rear to ensure a good seal, making sure the ground wire does not become tangled.

13. Seal & Frame the unit as described on the last page of these instructions.

14. If you have difficulty with mounting the grill to the sleeve, follow the instructions for direct mounting on Page 13.



Installation Instructions

Wall Sleeve Brands:

#3 Fedders or Friedrich

16-3/4" Deep

1. Remove existing rear grille as shown on Page 3 of this manual and replace with provided louvered rear panel. Install as shown here.

NOTE: You may need to drill holes in flange of existing sleeve to match new rear grille

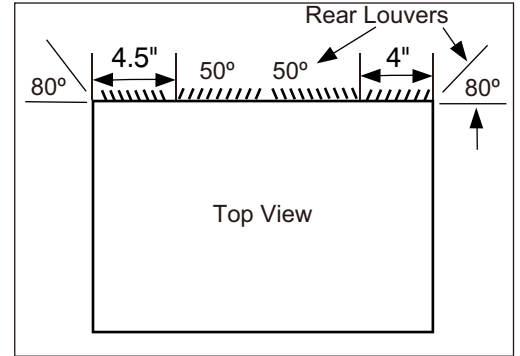

2. Attach (2) 4 1/2" x 3 1/2" x 1 1/2" centering/support blocks one on each side wall. Place in center of side wall with the tapered end facing the opening.

3. Cut (2) 17" Tapered Spacer Blocks as shown below into two pieces.

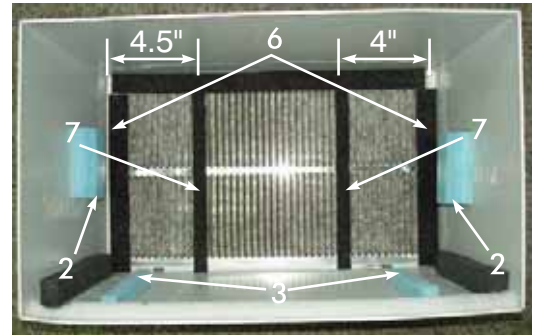
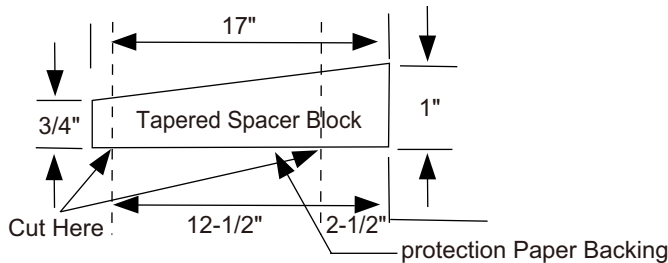

4. The 2 1/2" section is placed in front of the rib on base with the tapered end facing the back of the sleeve. Cut the remaining portion to 12 1/2" and place behind the rib again sloping toward the rear of the sleeve. This helps induce a rearward slope on the unit.

5. Attach (1) 1" x 3/8" x 25" long seal in the center at the top of the sleeve. Remove the backing paper and press into position.

6. Attach (2) 1" x 3/8" x 14" seals to the left and right sides of the sleeve.

7. Cut (2) 1" x 3/8" x 25" long seals to 14" long each and attach to the vertical sections of the grille as shown.

8. Gently slide unit into sleeve.

9. Before sliding all-the-way back, remove 2nd screw from front on left side of unit.

10. Remove the plastic washer from the screw.

11. Screw and attach the other end of the ground wire from sleeve to the unit as shown in picture. Make sure that the toothed washer is against the cabinet.

12. Slide the unit completely to the rear to ensure a good seal, making sure the ground wire does not become tangled.

13. Seal & Frame the unit as described on the last page of these instructions.

14. If you have difficulty with mounting the grill to the sleeve, follow the instructions for direct mounting on Page 13.



Installation Instructions

Wall Sleeve Brands:

#4 General Electric/Hotpoint

16-7/8" Deep

1. Remove existing rear grille as shown on Page 3 of this manual and replace with provided louvered rear panel. Install as shown here.

NOTE: You may need to drill holes in flange of existing sleeve to match new rear grille

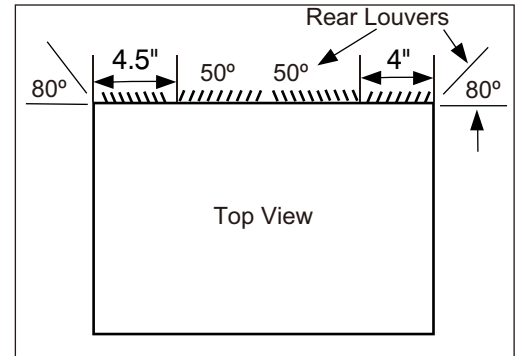

2. Cut (2) 17" Tapered Spacer Blocks as shown below into two pieces.

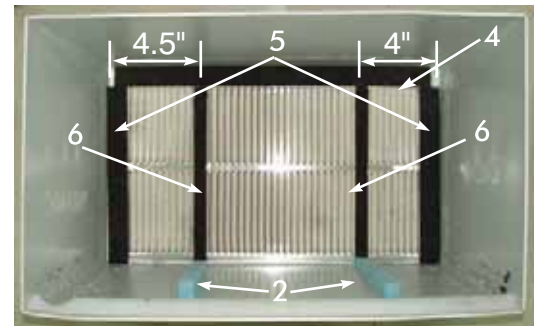
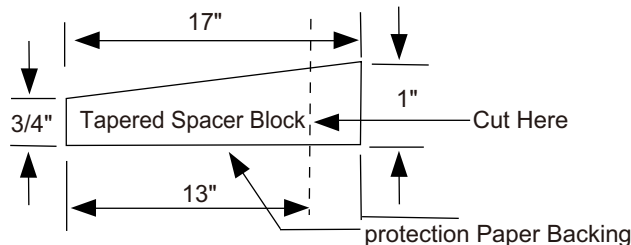

3. Install as shown with the tapered end 1/2" from the back of the sleeve. This helps induce a rearward slope on the unit.

4. Attach (1) 1" x 3/8" x 25" long seal in the center at the top of the sleeve. Remove the backing paper and press into position.

5. Attach (2) 1" x 3/8" x 14" seals to the left and right sides of the sleeve.

6. Cut (2) 1" x 3/8" x 25" long seals to 14" long each and attach to the vertical sections of the grille as shown.

7. Center unit & gently slide unit into sleeve.

8. Before sliding all-the-way back, remove 2nd screw from front on left side of unit.

9. Remove the plastic washer from the screw.

10. Screw and attach the other end of the ground wire from sleeve to the unit as shown in picture. Make sure that the toothed washer is against the cabinet.

11. Slide the unit completely to the rear to ensure a good seal, making sure the ground wire does not become tangled.

12. Seal & Frame the unit as described on the last page of these instructions.

13. If you have difficulty with mounting the grill to the sleeve, follow the instructions for direct mounting on Page 13.



Installation Instructions

Wall Sleeve Brands:

#5 Sears or Carrier 51S Series

18-5/8" Deep

1. Remove existing rear grille as shown on Page 3 of this manual and replace with provided louvered rear panel. Install as shown here.

NOTE: You may need to drill holes in flange of existing sleeve to match new rear grille

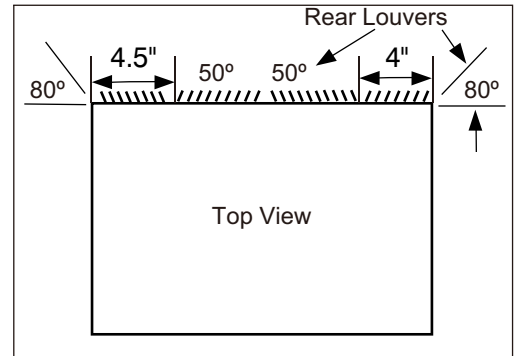

2. Install (2) tapered spacer blocks to the floor of the sleeve as shown. This helps induce a rearward slope on the unit.
3. Install as shown with the tapered end 1/2" from the back of the sleeve. This helps induce a rearward slope on the unit.
4. Attach (1) 1" x 3/8" x 25" long seal in the center at the top of the sleeve. Remove the backing paper and press into position
5. Attach (2) 1" x 3/8" x 14" seals to the left and right sides of the sleeve.
6. Cut (2) 1" x 3/8" x 25" long seals to 14" long each and attach to the vertical sections of the grille as shown.
7. Center unit & gently slide unit into sleeve.
8. Before sliding all-the-way back, remove 2nd screw from front on left side of unit.
9. Remove the plastic washer from the screw.
10. Screw and attach the other end of the ground wire from sleeve to the unit as shown in picture. Make sure that the toothed washer is against the cabinet.
11. Slide the unit completely to the rear to ensure a good seal, making sure the ground wire does not become tangled.
12. Seal & Frame the unit as described on the last page of these instructions.
13. If you have difficulty with mounting the grill to the sleeve, follow the instructions for direct mounting on Page 13.

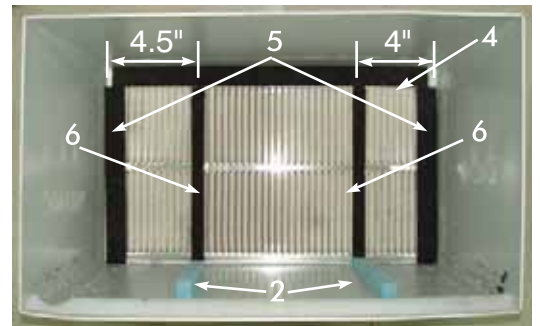

Installation Instructions

Wall Sleeve Brands:

#6 Whirlpool

17-1/8" Deep

1. Remove existing rear grille as shown on Page 3 of this manual and replace with provided louvered rear panel. Install as shown here.

NOTE: You may need to drill holes in flange of existing sleeve to match new rear grille

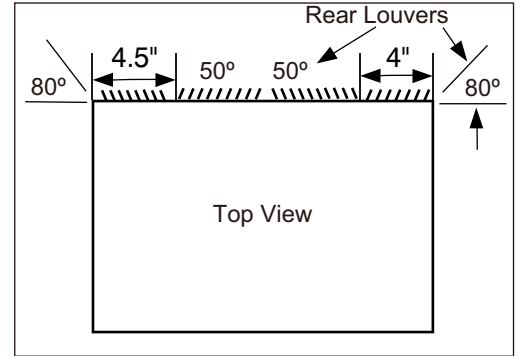

2. Cut (2) 17" Tapered Spacer Blocks as shown below into two pieces.

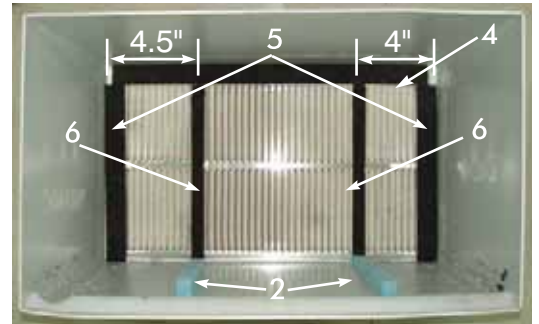
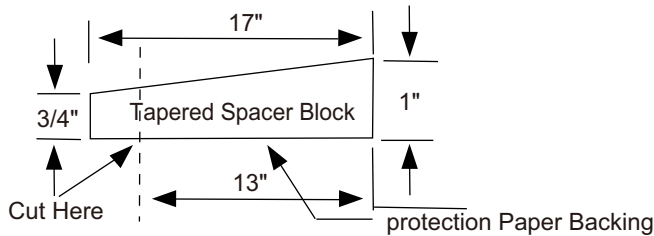

3. Install to the floor of the sleeve as shown. This helps induce a rearward slope on the unit.
4. Attach (1) 1" x 3/8" x 25" long seal in the center at the top of the sleeve. Remove the backing paper and press into position.
5. Attach (2) 1" x 3/8" x 14" seals to the left and right sides of the sleeve.
6. Cut (2) 1" x 3/8" x 25" long seals to 14" long each and attach to the vertical sections of the grille as shown.
7. Center unit & gently slide unit into sleeve.
8. Before sliding all-the-way back, remove 2nd screw from front on left side of unit.
9. Remove the plastic washer from the screw.
10. Screw and attach the other end of the ground wire from sleeve to the unit as shown in picture. Make sure that the toothed washer is against the cabinet.
11. Slide the unit completely to the rear to ensure a good seal, making sure the ground wire does not become tangled.
12. Seal & Frame the unit as described on the last page of these instructions.
13. If you have difficulty with mounting the grill to the sleeve, follow the instructions for direct mounting on Page 13.



Installation Instructions

Wall Sleeve Brands:

#7 Whirlpool

23" Deep

1. Remove existing rear grille as shown on Page 3 of this manual and replace with provided louvered rear panel. Install as shown here.

NOTE: You may need to drill holes in flange of existing sleeve to match new rear grille

Because of the increased unit depth, first try dry fitting using the method described below:

2. Place (2) 1" x 1½" x 14" seals against each side.
3. Gently slide unit in and check if amount extending from the sleeve is sufficient once the trim frame is attached.
4. If position is okay, remove unit and Proceed to the next step. If not go to step 9.
5. Attach (1) 1" x 1½" x 25" long seal in the center at the top of the sleeve. Remove the backing paper and press into position.
6. Attach (2) 1" x 1½" x 14" seals to the left and right sides of the sleeve.
7. Cut (2) 1" x 3/8" x 25" long seal to 14" long each and attach to the vertical sections of the grille as shown.
8. Attach the tapered spacer blocks to the floor of the sleeve. Now go to step 15.

Use these next steps if the unit requires extra extension into the room.

9. Attach 1" x ¾" x 14" long seal over the solid vertical portion of the rear grille.
10. Attach (2) 4¾" x 3¾" x 1¾" foam blocks with the slot overlapping the seal above.
11. Install the divider into the slots of the foam blocks. You may need to trim the length to size.
12. Repeat steps 9-11 for the other vertical shown portion of the grille as shown in the picture.
13. Attach (2) 1" x 1½" x 14" seals along the sides of the sleeve again making sure all seals are flush.
14. Cut the 1" x 1½" x 25" seal to fit the top of the sleeve. The pieces must be fitted flush to the edge of the divider.
15. Center unit & gently slide unit into sleeve.
16. Before sliding all-the-way back, remove 2nd screw from front on left side of unit.
17. Remove the plastic washer from the screw.
18. Screw and attach the other end of the ground wire from sleeve to the unit as shown in picture. Make sure that the toothed washer is against the cabinet.
19. Slide the unit completely to the rear to ensure a good seal, making sure the ground wire does not become tangled.
20. Seal & Frame the unit as described on the last page of these instructions.
21. If you have difficulty with mounting the grill to the sleeve, follow the instructions for direct mounting on Page 13.

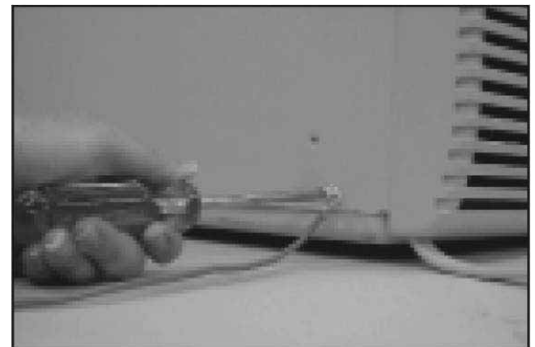
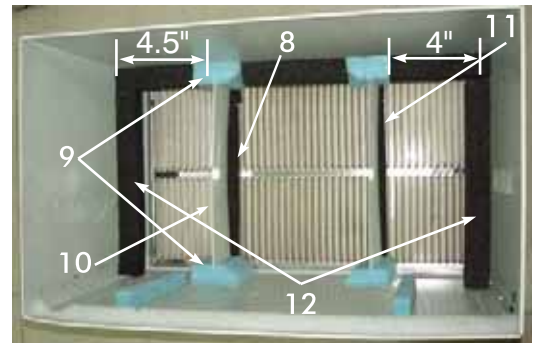
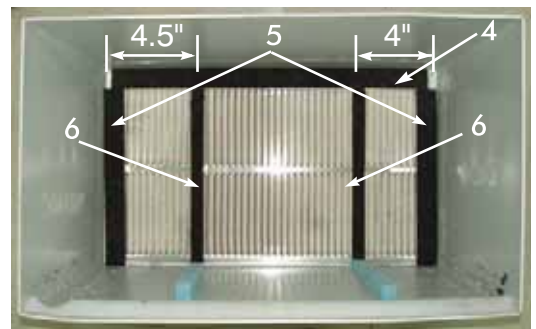
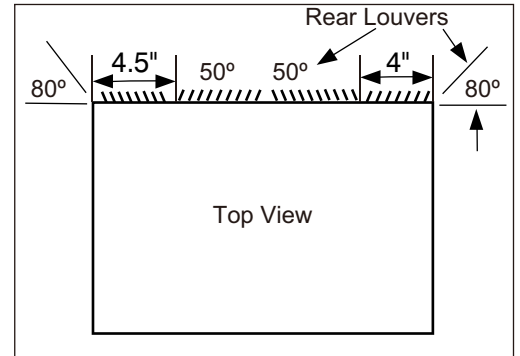

Installation Instructions

Wall Sleeve Brands:

#8 White Westinghouse/Frigidaire/
Carrier 52F Series

16"+ 17-1/2" Deep

1. Remove existing rear grille as shown on Page 3 of this manual and replace with provided louvered rear panel. Install as shown here.

NOTE: You may need to drill holes in flange of existing sleeve to match new rear grille

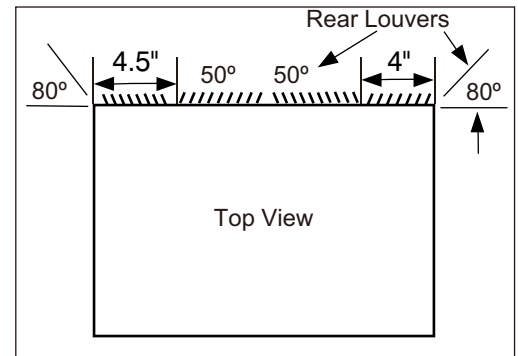

2. Attach (1) 1" x 3/8" x 25" long seal in the center at the top of the sleeve. Remove the backing paper and press into position.
3. Attach (2) 1" x 3/8" x 14" seals to the left and right sides of the sleeve.
4. Attach (1) 1" x 3/4" x 14" long seal vertically 3.5" from the left side of the sleeve. Attach the other 1" x 3/4" x 14" long seal 3" from the right side of the sleeve.
5. Center unit & gently slide unit into sleeve.
6. Before sliding all-the-way back, remove 2nd screw from front on left side of unit.
7. Remove the plastic washer from the screw.
8. Screw and attach the other end of the ground wire from sleeve to the unit as shown in picture. Make sure that the toothed washer is against the cabinet.
9. Slide the unit completely to the rear to ensure a good seal, making sure the ground wire does not become tangled.
10. Seal & Frame the unit as described on the last page of these instructions.
11. If you have difficulty with mounting the grill to the sleeve, follow the instructions for direct mounting on Page 13.

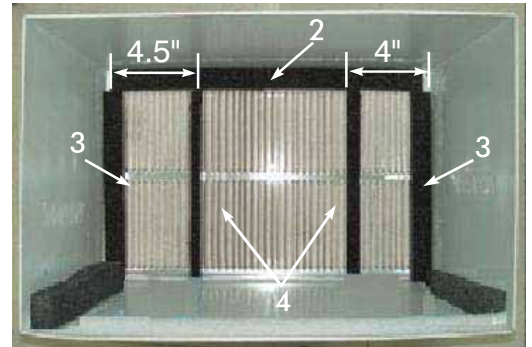

Installation Instructions

Wall Sleeve Brands:

#9 White Westinghouse or Frigidaire

22" Deep

1. Remove existing rear grille as shown on Page 3 of this manual and replace with provided louvered rear panel. Install as shown here.

NOTE: You may need to drill holes in flange of existing sleeve to match new rear grille

Because of the increased unit depth, first try dry fitting using the method described below:

2. Place (2) 1" x 1½" x 14" seals against each side.
3. Gently slide unit in and check if amount extending from the sleeve is sufficient once the trim frame is attached.
4. If position is okay, remove unit and Proceed to the next step. If not go to step 8.
5. Attach (1) 1" x 1½" x 15" seal to the left and right sides of the sleeve.
6. Cut (1) 1" x 1½" x 25" long seal to 14" long and attach it vertically to the rear grill 3.5" from the left side. Repeat and attach 3" from the right side.
7. Attach (1) 1" x 1½" x 25" long seal in the center at the top of the sleeve. Remove the backing paper and press into position. Proceed to step 14.

Use these next steps if the unit requires extra extension into the room.

8. Attach 1" x ¾" x 14" long seal over the solid vertical portion of the rear grille.
9. Attach (2) 4 ¾" x 3 ¾" x 1 ¼" foam blocks with the slot overlapping the seal above.
10. Install the divider into the slots of the foam blocks. You may need to trim the length to size.
11. Repeat steps 8-10 for the other vertical shown portion of the grille as shown in the picture.
12. Attach (2) 1" x 1½" x 14" seals along the sides of the sleeve again making sure all seals are flush.
13. Cut the 1" x 1½" x 25" seal to fit the top of the sleeve. The pieces must be fitted flush to the edge of the divider.
14. Center unit & gently slide unit into sleeve.
15. Before sliding all-the-way back, remove 2nd screw from front on left side of unit.
16. Remove the plastic washer from the screw.
17. Screw and attach the other end of the ground wire from sleeve to the unit as shown in picture. Make sure that the toothed washer is against the cabinet.
18. Slide the unit completely to the rear to ensure a good seal, making sure the ground wire does not become tangled.
19. Seal & Frame the unit as described on the last page of these instructions.
20. If you have difficulty with mounting the grill to the sleeve, follow the instructions for direct mounting on Page 13.

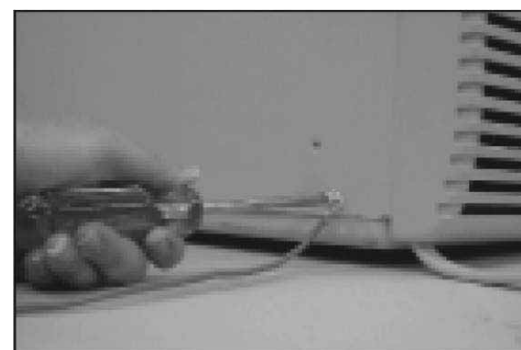
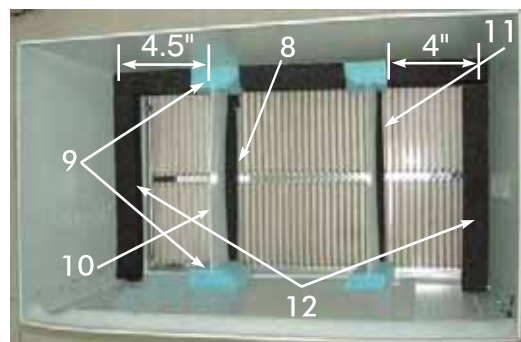
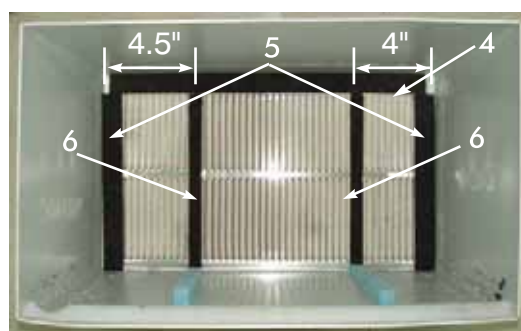
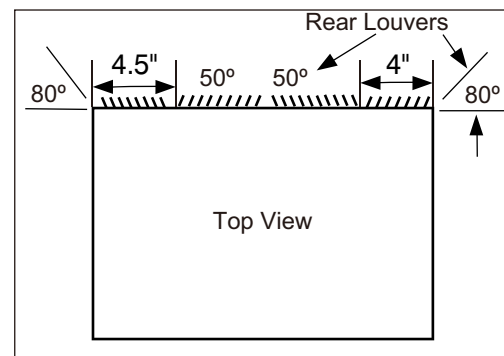

Installation Instructions

Direct Unit Mounting

The previous directions are the preferable way to mount the new rear grill. The unit's performance is slightly better and the possibility of draughts is reduced. As a last resort, direct mounting of the grille to the unit can be considered.

Note: The grille must be installed prior to inserting the unit into the sleeve.

1. Attach the 2 seal pieces (1"X3/8"X14") as shown in Fig. 1.
2. Position the grille over the rear of the unit making sure that:
 - a. The double set of screw holes are at the bottom.
 - b. The fins of the grill are pointed away from the unit.
3. Align the top of the grille with the top of the unit. The overhang on each side is equal.
4. If the unit has not been pre-drilled (some models), carefully drill 4 – 1/8" holes through the grille and into the side flange of the unit approximately 1 1/2" to 2" from the top and bottom as in Fig. 2, 3 .
(Be careful not to drill into the copper heat exchanger coils.)
5. Install 4 - #8 self tapping screws to affix the grille to the unit.
6. Insert the unit into the sleeve.

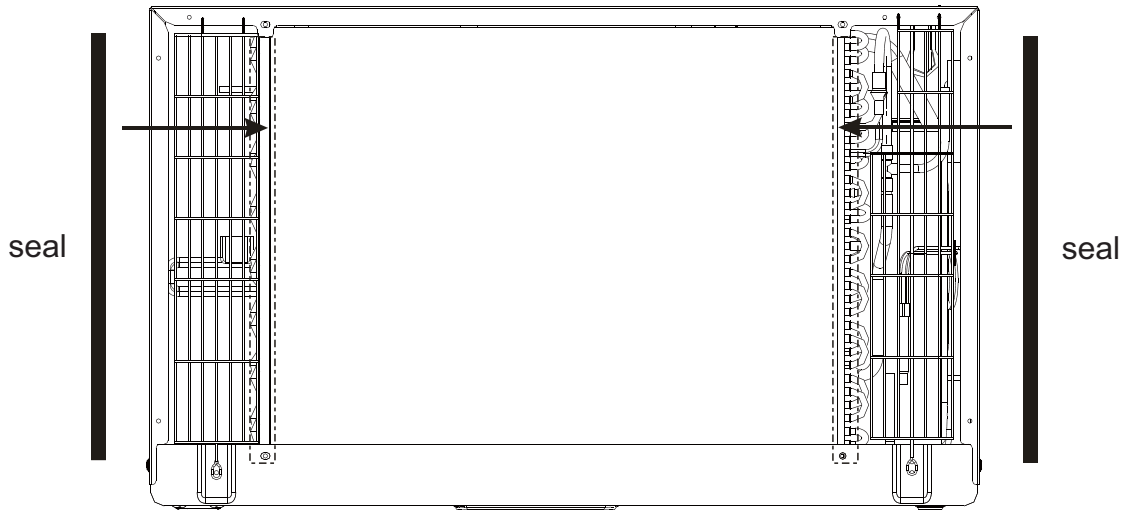

Fig. 1

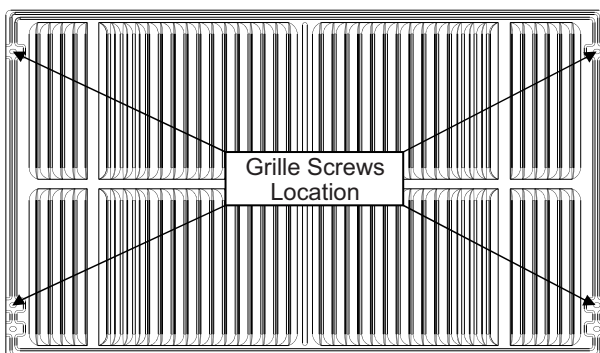

Fig. 2

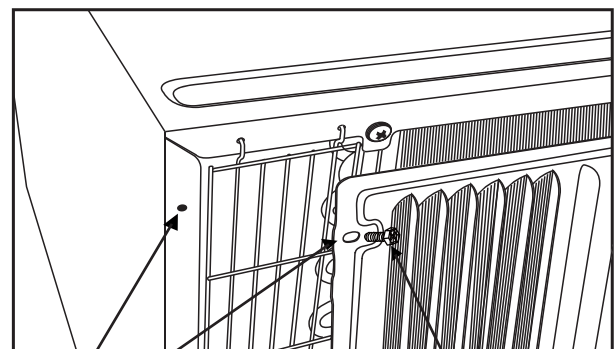

Fig. 3

1/8 Hole
Grille &
Flange

8 Screw

Installation Instructions

FINISHING INSTALLATION:

1. Install the 1" x 1½" x 84" long stuffer seal between the wall-sleeve and the unit. A flat-bladed screwdriver or putty knife is recommended.



2. Assemble the trim frame by inserting top and bottom pieces into side pieces and snapping into place.

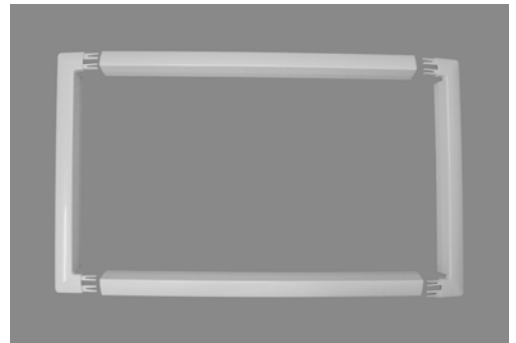

3. Pull cord through trim frame then slide over unit until flush with wall.

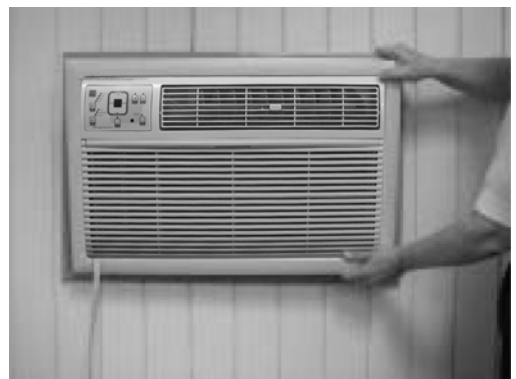

NOTE:For larger sleeves, an accessory trim kit is available(EA120T).