

# FRIGIDAIRE

All about the

# Use & Care

of your Electric Range

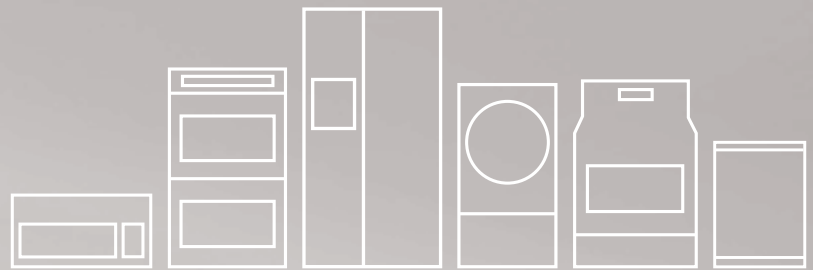

## TABLE OF CONTENTS

Important Safety Instructions .....	3-5	Setting Oven Controls .....	12-15
Before Setting Oven Controls .....	6	Care & Cleaning .....	16-19
Before Setting Surface Controls .....	7-8	Before You Call .....	20-21
Setting Surface Controls (Ceramic cooktop) ....	9-11	Major Appliance Warranty .....	22
Oven Control Functions (100) .....	12		

new 316902305 Rev B (August 2012)

# PRODUCT RECORD AND REGISTRATION

## Contents

Product Registration .....	2
<b>Important Safety Instructions .....</b>	<b>3-5</b>
<b>Before Setting Oven Controls .....</b>	<b>6</b>
Removing, replacing & arranging the oven racks .....	6
<b>Before Setting Surface Controls .....</b>	<b>7-8</b>
About the ceramic cooktop & radiant elements .....	7
Cookware material types .....	8
<b>Setting Surface Controls .....</b>	<b>9-11</b>
Setting single radiant surface elements .....	9
Setting dual radiant surface elements .....	10
Home canning .....	11
<b>Oven Control Functions .....</b>	<b>12</b>
<b>Setting Oven Controls .....</b>	<b>12-15</b>
Setting the clock .....	12
Changing oven temperature display (F° or C°) .....	12
Setting minute timer .....	13
Setting bake .....	13
Setting broil .....	14
Adjusting oven temperature .....	15
Operating oven light .....	15
<b>Care &amp; Cleaning .....</b>	<b>16-19</b>
Cleaning recommendation table .....	16
Cooktop maintenance & cleaning .....	17-18
Cautions for aluminum use .....	18
Replacing the oven light .....	18
Removing & replacing oven door .....	19
<b>Before You Call</b>	
Solutions to common problems .....	20-21
<b>Appliance Warranty .....</b>	<b>22</b>

Thank you for choosing **Frigidaire**.

This Use & Care Guide is part of our commitment to customer satisfaction and product quality throughout the service life of your new appliance. We view your purchase as the beginning of a relationship. To ensure our ability to continue serving you, please use this page to record important product information.

### Need help??

**Visit the Frigidaire web site at [www.frigidaire.com](http://www.frigidaire.com)**

Before you call for service, there are a few things you can do to help us serve you better.

### Read this Use & Care manual.

It contains instructions to help you use and maintain your range properly.

### If you received a damaged range ...

immediately contact the dealer (or builder) that sold you the range.

### Save time and money.

Check the section titled "Before you call". This section helps step you through some common problems that might occur. If you do need service, help is only a phone call away. Call Frigidaire Customer Services at **1-800-944-9044**.

### Product Registration

Registering your product with Frigidaire enhances our ability to serve you. You can register online at **[www.frigidaire.com](http://www.frigidaire.com)** or by dropping your Product Registration Card in the mail.

### Serial plate location



Serial plate location:  
open storage drawer (some models) or  
remove lower front panel (some models).

### Record model & serial numbers here

\_\_\_\_\_  
Purchase date

\_\_\_\_\_  
Model number

\_\_\_\_\_  
Serial number

Be sure to visit us online at  
**[www.frigidaire.com](http://www.frigidaire.com)**  
for a complete line of accessories.

## IMPORTANT SAFETY INSTRUCTIONS

### Read all instructions before using this appliance.

Do not attempt to install or operate your appliance until you have read the safety precautions in this manual. Safety items throughout this manual are labeled with a WARNING or CAUTION statement based on the risk type.

#### Definitions

 This is the safety alert symbol. It is used to alert you to potential personal injury hazards. Obey all safety messages that follow this symbol to avoid possible injury or death.

#### WARNING

**WARNING indicates a potentially hazardous situation which, if not avoided, may result in death or serious injury.**

#### CAUTION

**CAUTION indicates a potentially hazardous situation which, if not avoided, may result in minor or moderate injury.**

#### IMPORTANT

**IMPORTANT indicates installation, operation, maintenance or valuable information that is not hazard related.**

### Important Safety Instructions

- **Remove all tape and packaging before using the range.** Destroy the carton and plastic bags after unpacking the range. Never allow children to play with packaging material.
- **Proper installation—Be sure your appliance is properly installed and grounded by a qualified technician in accordance with the National Electrical Code ANSI/NFPA No. 70 latest edition and local electrical code requirements.** Install only per installation instructions provided in the literature package for this range.
- **User servicing—Do not repair or replace any part of the appliance unless specifically recommended in the manuals.** All other servicing should be done only by a qualified technician. This may reduce the risk of personal injury and damage to the range.  
Ask your dealer to recommend a qualified technician and an authorized repair service. Know how to disconnect the power to the range at the circuit breaker or fuse box in case of an emergency.

#### WARNING

##### Tip Over Hazard

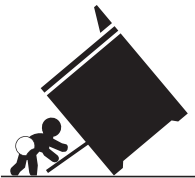

- **A child or adult can tip the range and be killed.**
- **Verify the anti-tip device has been installed to floor or wall.**
- **Ensure the anti-tip device is re-engaged when the range is moved to floor or wall.**
- **Do not operate the range without the anti-tip device in place and engaged.**
- **Failure to follow these instructions can result in death or serious burns to children and adults.**

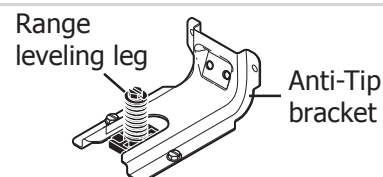

To check if the anti-tip bracket is installed properly, use both arms and grasp the rear edge of range back. Carefully attempt to tilt range forward. When properly installed, the range should not tilt forward.

Refer to the anti-tip bracket **installation instructions** supplied with your range for proper installation.

- **Never modify or alter the construction of a range by removing the leveling legs, panels, wire covers, anti-tip brackets/screws, or any other part of the range.**
- **Remove the oven door from any unused range if it is to be stored or discarded.**

#### WARNING

**Stepping, leaning or sitting on the door or drawers of a range can result in serious injuries and also cause damage to the appliance.** DO NOT allow children to climb or play around the range. The weight of a child on an open oven door may cause the range to tip, resulting in serious burns or other injury.

**Never use your appliance for warming or heating the room.**

**Do not use the oven, warmer drawer or lower oven (if equipped) for storage.**

**Save these instructions for future reference.**

## IMPORTANT SAFETY INSTRUCTIONS

### WARNING

- **Storage in or on appliance—flammable materials should not be stored in an oven, warmer drawer, near surface units or in the storage drawer.** This includes paper, plastic and cloth items, such as cookbooks, plasticware and towels, as well as flammable liquids. Do not store explosives, such as aerosol cans, on or near the range.
- **DO NOT LEAVE CHILDREN ALONE—children should not be left alone or unattended in the area where appliance is in use.** They should never be allowed to sit or stand on any part of the appliance, including the storage drawer, lower broiler drawer, warmer drawer or lower double oven.

### CAUTION

- **Do not store items of interest to children in the cabinets above a range or on the backguard of the range.** Children climbing on the range to reach items could be seriously injured.
- **Do not touch surface heating units or surface cooking elements, areas near these units or elements, or interior surface of the oven.** Both surface heating and oven heating elements may be hot even though they are dark in color. Areas near surface cooking units may become hot enough to cause burns. During and after use, do not touch, or let clothing or other flammable materials touch these areas until they have had sufficient time to cool. Among these areas are the cook top, surfaces facing the cook top, the oven vent openings and surfaces near these openings, oven door and oven door window.
- **Wear proper apparel—loose-fitting or hanging garments should never be worn while using the appliance.** Do not let clothing or other flammable materials contact hot surfaces.

### IMPORTANT

**Do not attempt to operate the range during a power failure.** If the power fails, always turn off the range. If the range is not turned off and the power resumes, the range will begin to operate again. Once the power resumes, reset the clock and oven function.

- **Do not use water or flour on grease fires—smother the fire with a pan lid, or use baking soda, a dry chemical or foam-type extinguisher.**
- **When heating fat or grease, watch it closely.** Fat or grease may catch fire if allowed to become too hot.
- **Use dry potholders - moist or damp potholders on hot surfaces may result in burns from steam.** Do not let potholders touch hot heating elements. Do not use a towel or other bulky cloth instead of a potholder.
- **Do not heat unopened food containers - buildup of pressure may cause container to burst and result in injury.**

### IMPORTANT INSTRUCTIONS FOR USING YOUR OVEN

- **Use care when opening oven door, lower oven door or warmer drawer (if equipped)—**Stand to the side of the range when opening the door of a hot oven. Let hot air or steam escape before you remove or replace food in the oven.
- **Keep oven vent ducts unobstructed.** The oven vent is located under the left rear surface element if your model is equipped with coil elements. The oven vent is located below the backguard for models equipped with ceramic-glass cook tops. Touching the surfaces in this area when the oven is operating may cause severe burns. Also, do not place plastic or heat-sensitive items on or near the oven vent. These items could melt or ignite.
- **Placement of interior oven racks.** Always place oven racks in desired location while oven is cool. If rack must be moved while oven is hot use extreme caution. Use potholders and grasp the rack with both hands to reposition. Do not let potholders contact the hot heating elements in the oven. Remove all utensils from the rack before moving.
- **Do not use the broiler pan without its insert.** The broiler pan and its insert allow dripping fat to drain and be kept away from the high heat of the broiler. **Do not cover the broiler insert with aluminum foil. Exposed fat and grease could ignite.**
- **Protective liners—**Do not use aluminum foil to line the oven bottom. Only use aluminum foil as recommended in this manual. Improper installation of these liners may result in risk of electric shock, or fire.

## IMPORTANT SAFETY INSTRUCTIONS

### IMPORTANT INSTRUCTIONS FOR USING YOUR COOKTOP

- **Know which knob controls each surface heating unit.** Place a pan of food on the unit before turning it on, and turn the unit off before removing the pan.
- **Use proper pan size**—This appliance is equipped with one or more surface units of different sizes. Select utensils having flat bottoms large enough to cover the surface unit heating element. The use of undersized utensils will expose a portion of the heating element to direct contact and may result in ignition of clothing. Proper relationship of utensil to element will also improve efficiency.
- **Utensil handles should be turned inward and not extend over adjacent surface elements**—To reduce the risk of burns, ignition of flammable materials, and spillage due to unintentional contact with the utensil, the handle of the utensil should be positioned so that it is turned inward, and does not extend over adjacent surface units.
- **Never leave surface elements unattended at high heat settings**—Boilovers cause smoking and greasy spillovers that may ignite, or a pan that has boiled dry may melt.
- **Do not immerse or soak removable heating elements**—Heating elements should never be immersed in water. Heating elements clean themselves during normal operation.
- **Glazed cooking utensils**—Only certain types of glass, glass/ceramic, ceramic, earthenware, or other glazed utensils are suitable for cook top service without breaking due to the sudden change in temperature. Check the manufacturer's recommendations for cook top use.
- **When flaming foods under a ventilating hood, turn the fan on.**

### FOR CERAMIC-GLASS COOK TOP MODELS

- **Do not cook on broken cook top**—If cook top should break, cleaning solutions and spillovers may penetrate the broken cook top and create a risk of electric shock. Contact a qualified technician immediately.
- **Clean cook top with caution**—If a wet sponge or cloth is used to wipe spills on a hot cooking area, be careful to avoid a steam burn. Some cleaners can produce noxious fumes if applied to a hot surface.

### IMPORTANT INSTRUCTIONS FOR CLEANING YOUR RANGE

- **Clean the range regularly to keep all parts free of grease that could catch fire.** Pay particular attention to the area around each surface element. Do not allow grease to accumulate.
- **Kitchen cleaners and aerosols—Always follow the manufacturer's recommended directions for use.** Be aware that excess residue from cleaners and aerosols may ignite causing damage and injury.
- **Clean ventilating hoods frequently—Grease should not be allowed to accumulate on the hood or filter.** Follow the manufacturer's instructions for cleaning hoods.

### IMPORTANT SAFETY NOTICE

The California Safe Drinking Water and Toxic Enforcement Act requires the Governor of California to publish a list of substances known to the state to cause cancer, birth defects or other reproductive harm, and requires businesses to warn customers of potential exposure to such substances.

## BEFORE SETTING OVEN CONTROLS

### Oven vent location

The oven vent is located **under the left side of the control panel** (See Fig. 1). When the oven is on, warm air passes through this vent. This venting is necessary for proper air circulation in the oven and good baking results. **Do not block the oven vent.**

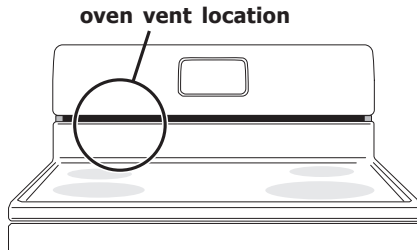
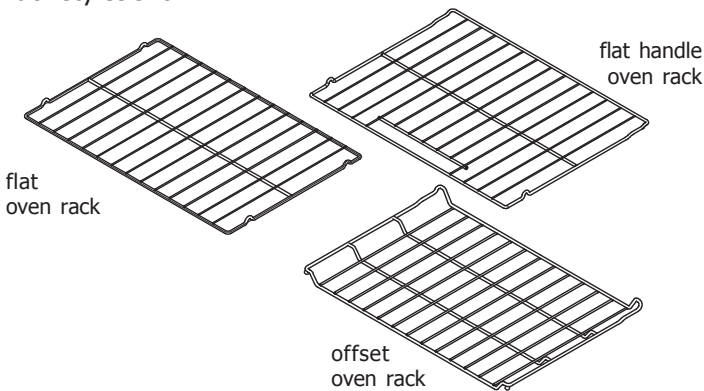

Fig. 1

### Types of oven racks

Your range may be equipped with one or more of the oven rack styles shown.



The **flat oven rack** or **flat handle oven rack** (some models) may be used for most cooking needs.

The **offset oven rack** (some models) is designed to place the base of the rack about 1/2 of a rack position lower than normal. This rack design provides several additional possible locations between the standard positions.

### Removing, replacing & arranging racks

**To remove** - pull the rack forward until it stops. Lift up front of rack and slide out.

**To replace** - fit the rack onto the guides on the oven walls. Tilt the front of the rack upward and slide the rack back into place.

**Arranging** - always arrange the oven racks when the oven is cool (prior to operating the oven).

### CAUTION

**Always use oven mitts when using the oven.** When using the appliance, oven racks and cooktop will become very hot which can cause burns.

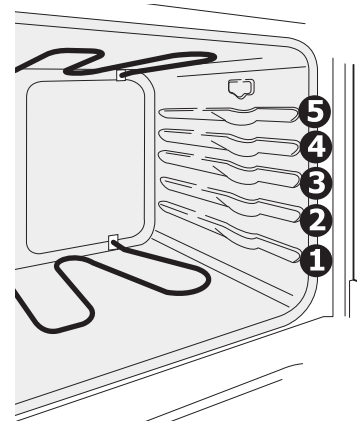

Fig. 2

### Recommended rack positions by food type

Food type	Position
Broiling meats	See broil
Cookies, cakes, pies, biscuits & muffins	2 or 3
Frozen pies, angel food cake, yeast, bread and casseroles	1 or 2
Small cuts of meat or poultry	1 or 2
Turkey, roast or ham	1

### Air circulation in the oven

For best baking results allow 2-4" (5-10 cm) around the cookware for proper air circulation and be sure pans and cookware do not touch each other, the oven door, sides or back of the oven cavity. Hot air must be able to circulate around the pans and cookware in the oven for even heat to reach around the food.



## BEFORE SETTING SURFACE CONTROLS

### About the ceramic glass cooktop

The ceramic cooktop has radiant surface elements located below the surface of the glass. The design of the ceramic cooktop outlines the area of the surface element underneath. **Be sure** to match the pan size with the diameter of the element outline on the cooktop and only flat-bottomed cookware should be used.

The type and size of cookware, the number of surface elements in use and their settings are all factors that will affect the amount of heat that will spread to areas beyond the surface elements. The areas surrounding the elements may become **hot enough to cause burns**.

### About the radiant surface elements

The element temperature rises gradually and evenly. As the temperature rises, the element will glow red. To maintain the selected setting the element will cycle ON and OFF. The heating element retains enough heat to provide a uniform and consistent heat during the off cycle.

For efficient cooking, turn OFF the element several minutes before cooking is complete. This will allow residual heat to complete the cooking process.

### Element on & hot surface indicator lights

Your appliance is equipped with two different types of radiant surface control indicator lights that will glow on the control panel — the **on** indicator and the **hot surface** indicator lights.

The element **on** indicator light will glow when any surface element is turned ON. A quick glance at this indicator light after cooking is an easy check to be sure the surface controls are turned OFF (See Fig. 1).

The **hot surface** indicator light will glow when any surface cooking area heats up and will **remain on** until the glass cooktop has cooled to a **MODERATE** level (See Fig. 2).

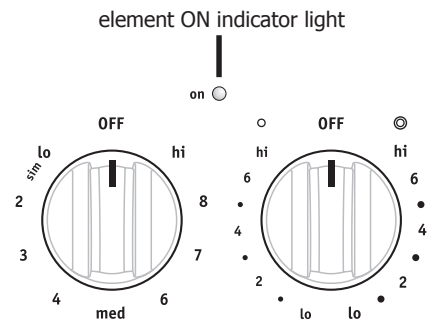

Fig. 1

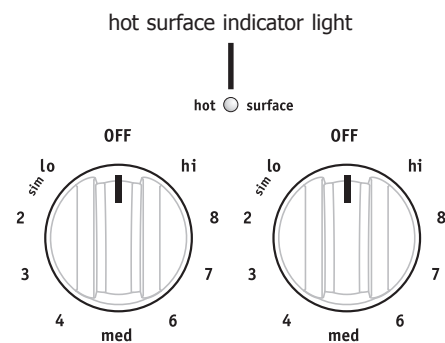

Fig. 2

### NOTES

Radiant elements have a limiter that allows the element to cycle ON and OFF, even at the HI setting. This helps to prevent damage to the ceramic smoothtop. Cycling at the HI setting is normal and will occur more often if the cookware is too small for the radiant element or if the cookware bottom is not flat.

**Be sure** to read the detailed instructions for ceramic glass cooktop cleaning in the **Care & Cleaning** and **Before You Call** checklist sections of this Use & Care Manual.

## BEFORE SETTING SURFACE CONTROLS

### Types of cooktop elements

The ceramic glass cooktop has radiant surface elements located below the surface of the glass. The patterns on the ceramic glass will outline the size and type of element available. The **single** radiant element will have one round outline pattern shown. The **dual** radiant element is flexible because you may set just the smaller inner portion as a single element or both inner and outer portions can be set to heat together (See Fig. 1).

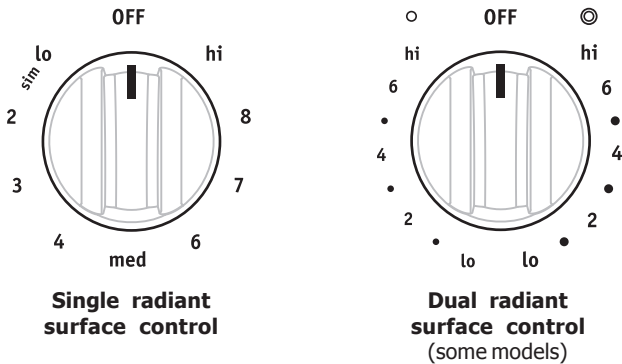

Fig. 1

### Cookware material types

The cookware material determines how evenly and quickly heat is transferred from the surface element to the pan bottom. The most popular materials available are:

**Aluminum** - Excellent heat conductor. Some types of food will cause it to darken (Anodized aluminum cookware resists staining & pitting). If aluminum pans slide across the ceramic cooktop, they may leave metal marks which will resemble scratches. Remove these marks immediately.

**Copper** - Excellent heat conductor but discolors easily. May leave metal marks on ceramic glass (see Aluminum).

**Stainless** - Slow heat conductor with uneven cooking results. Is durable, easy to clean and resists staining.

**Cast Iron** - A slow heat conductor however will retain heat very well. Cooks evenly once cooking temperature is reached. Not recommended for use on ceramic cooktops.

**Porcelain-enamel on metal** - Heating characteristics will vary depending on base material. Porcelain-enamel coating must be smooth to avoid scratching ceramic cooktops.

**Glass** - Slow heat conductor. Not recommended for ceramic cooktop surfaces because it may scratch the glass.

### Using proper cookware

The size and type of cookware used will influence the setting needed for best cooking results. Be sure to follow the recommendations for using proper cookware as illustrated in Figs. 2 & 3.

Cookware should have flat bottoms that make good contact with the entire surface heating element (See Fig. 2). Check for flatness by rotating a ruler across the bottom of the cookware (See Fig. 3). For more information about the ceramic cooktop see "Cooktop cleaning & maintenance" in the **Care & Cleaning** section.

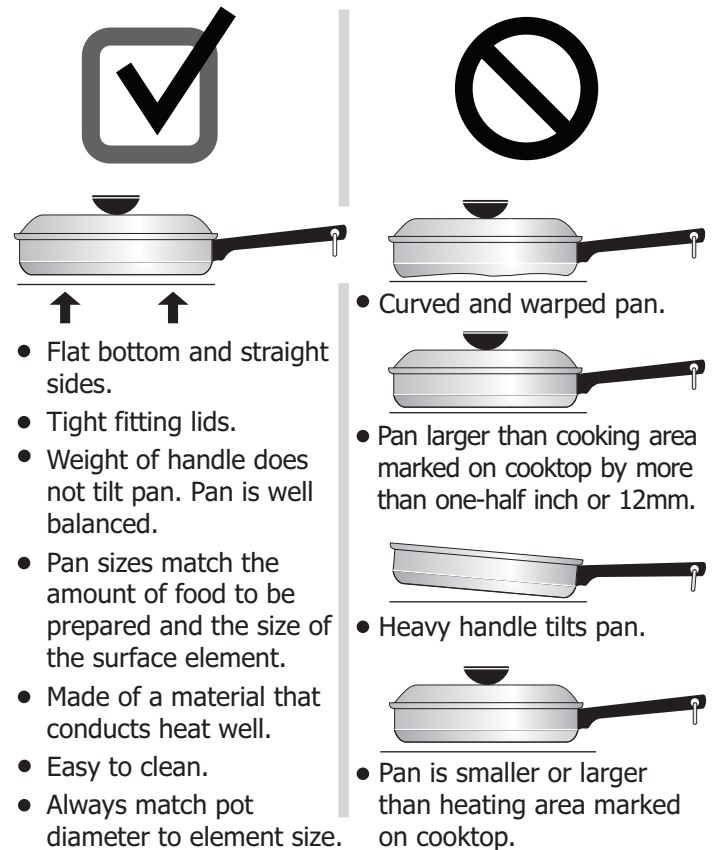

Fig. 2

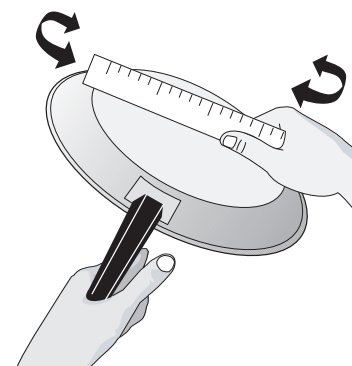

Fig. 3



## SETTING SURFACE CONTROLS

### Single radiant surface elements (all models)

#### To operate the single radiant element:

1. Place correctly sized cookware on single radiant surface element.
2. Push in and turn the surface control knob in either direction (Fig. 2) to the desired setting (Refer to the **Suggested radiant surface element settings table** Fig. 1). Start most cooking operations on a higher setting and then turn to a lower setting to finish cooking. The surface control knobs do not have to be set exactly on a particular spot. Use the graphics provided as a guide and adjust the control knob as needed (See Fig. 2). Each surface element provides a constant amount of heat at each setting. A glowing red surface heating area extending beyond the bottom edge of the cookware indicates the cookware is **too small** for the surface heating area.
3. When cooking is complete, turn the radiant surface element OFF before removing the cookware.

### Suggested radiant surface element settings

The suggested settings found in Fig.1 below are based when cooking with medium-weight aluminum pans with lids. Settings may vary when using other types of pans.

#### Suggested settings for single and dual radiant elements table

Settings	Type of cooking
High (HI - 9)	Start most foods, bring water to a boil, pan broiling
Medium high (7 - 8)	Continue a rapid boil, fry, deep fat fry
Medium (5 - 6)	Maintain a slow boil, thicken sauces and gravies or steam vegetables
Medium Low (2 - 4)	Keep foods cooking, poach, stew
Low (LO - 1)	Keep warm, melt, simmer

Fig. 1

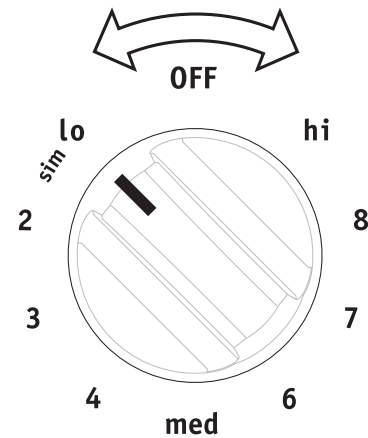

Fig. 2

### CAUTION

Radiant surface elements may appear to have cooled after they have been turned off. **The glass surface may still be hot** and burns may occur if the glass surface is touched before it has cooled sufficiently.

**Do not place flammable items** such as plastic salt and pepper shakers, spoon holders or plastic wrappings on top of the range when it is in use. These items could melt or ignite. Potholders, towels or wooden spoons could catch fire if placed too close to the surface elements.

### IMPORTANT

**Do not allow aluminum foil, or ANY material that can melt to make contact with the ceramic glass cooktop.** If these items melt on the cooktop they will damage the ceramic cooktop.

### NOTES

The size and type of utensil used, and the amount and type of food being cooked will influence the setting needed for best cooking results.

The **on** indicator light will glow when one or more elements are turned ON. A quick glance at this indicator light when cooking is finished is an easy check to be sure all control knobs are turned OFF. The **hot surface** indicator light will continue to glow AFTER the control knob is turned to the "OFF" position and will glow until the heating surface area has cooled sufficiently.

## SETTING SURFACE CONTROLS

**Dual radiant surface elements** (some models)  
Symbols on the backguard are used to indicate which coil of the dual radiant element will heat. The ○ symbol indicates the inner coil only. The ⊙ symbol indicates both inner and outer coils will heat.

### To operate a dual radiant element:

1. Place correctly sized cookware on dual radiant surface element.
2. Push in and turn the surface control knob clockwise to begin heating both the inner and outer portions of the dual element. If only the inner heating portion is needed like for smaller cookware, push in and turn the knob counter-clockwise to start.
3. When cooking is complete, turn the dual radiant surface element OFF before removing the cookware.

Start most cooking operations on a higher setting and then turn to a lower setting to finish cooking. The surface control knobs do not have to be set exactly on a particular mark. Use the marks as a guide and adjust the control knob as needed. A glowing red surface heating area extending beyond the bottom edge of the cookware indicates the cookware is **too small** for the surface heating area.

You may switch from either coil setting at any time during cooking. See **Suggested radiant surface element settings table** on previous page.

### CAUTION

Radiant surface elements may appear to have cooled after they have been turned off. **The glass surface may still be hot** and burns may occur if the glass surface is touched before it has cooled sufficiently.

**Do not place flammable items** such as plastic salt and pepper shakers, spoon holders or plastic wrappings on top of the range when it is in use. These items could melt or ignite. Potholders, towels or wooden spoons could catch fire if placed too close to the surface elements.

### IMPORTANT

**Do not allow aluminum foil, or ANY material that can melt to make contact with the ceramic glass cooktop.** If these items melt on the cooktop they will damage the ceramic cooktop.

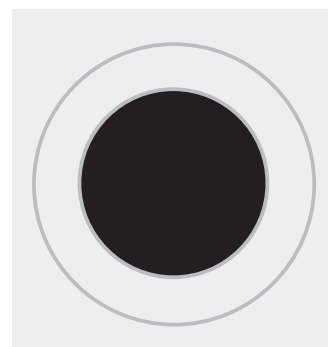
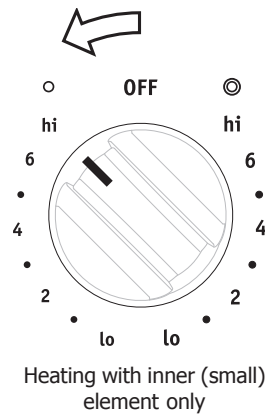

Areas that heat are shown darkened.

Fig. 1

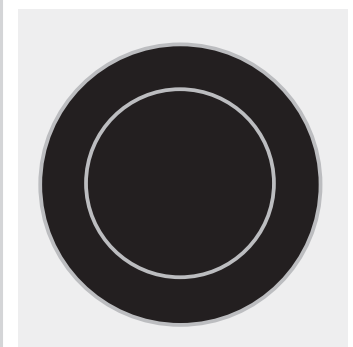
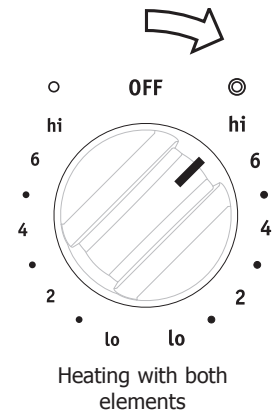

Fig. 2

### NOTES

The size and type of utensil used, and the amount and type of food being cooked will influence the setting needed for best cooking results.

The **on** indicator light will glow when one or more elements are turned ON. A quick glance at this indicator light when cooking is finished is an easy check to be sure all control knobs are turned OFF. The **hot surface** indicator light will continue to glow AFTER the control knob is turned to the "OFF" position and will glow until the heating surface area has cooled sufficiently.

## SETTING SURFACE CONTROLS

### Home Canning

Be sure to read and observe all the following points when home canning with your appliance. Check with the USDA (United States Department of Agriculture) website and be sure to read all the information they have available as well as follow their recommendations for home canning procedures.

- Use only quality flat bottom canners when home canning. Use a straight-edge to check canner bottom (see "Cookware material types" in the **Before setting surface controls** section).
- Use only a **completely flat bottom canner** with no ridges that radiate from the bottom center when home canning using a ceramic cooktop.
- **Make sure the diameter of the canner does not exceed 1 inch beyond the surface element markings or burner.** It is recommended to use smaller diameter canners on electric coil and ceramic glass cooktops.
- Start with hot tap water to bring water to boil more quickly.
- Use the highest heat setting when first bringing the water to a boil. Once boiling is achieved, reduce heat to lowest possible setting to maintain that boil.

#### **IMPORTANT**

**NEVER** place or straddle a cooking utensil over 2 different surface cooking areas at the same time. This may cause the ceramic cooktop to fracture.

#### **CAUTION**

Radiant surface elements may appear to have cooled after they have been turned off. **The glass surface may still be hot** and burns may occur if the glass surface is touched before it has cooled sufficiently.

**Do not place flammable items** such as plastic salt and pepper shakers, spoon holders or plastic wrappings on top of the range when it is in use. These items could melt or ignite. Potholders, towels or wooden spoons could catch fire if placed too close to the surface elements.

#### **IMPORTANT**

**Do not allow aluminum foil, or ANY material that can melt to make contact with the ceramic glass cooktop.** If these items melt on the cooktop they will damage the ceramic cooktop.

## OVEN CONTROL FUNCTIONS

### READ THE INSTRUCTIONS CAREFULLY BEFORE USING THE OVEN.

For satisfactory use of your oven, become familiar with the various pad features and functions of the oven as described below.

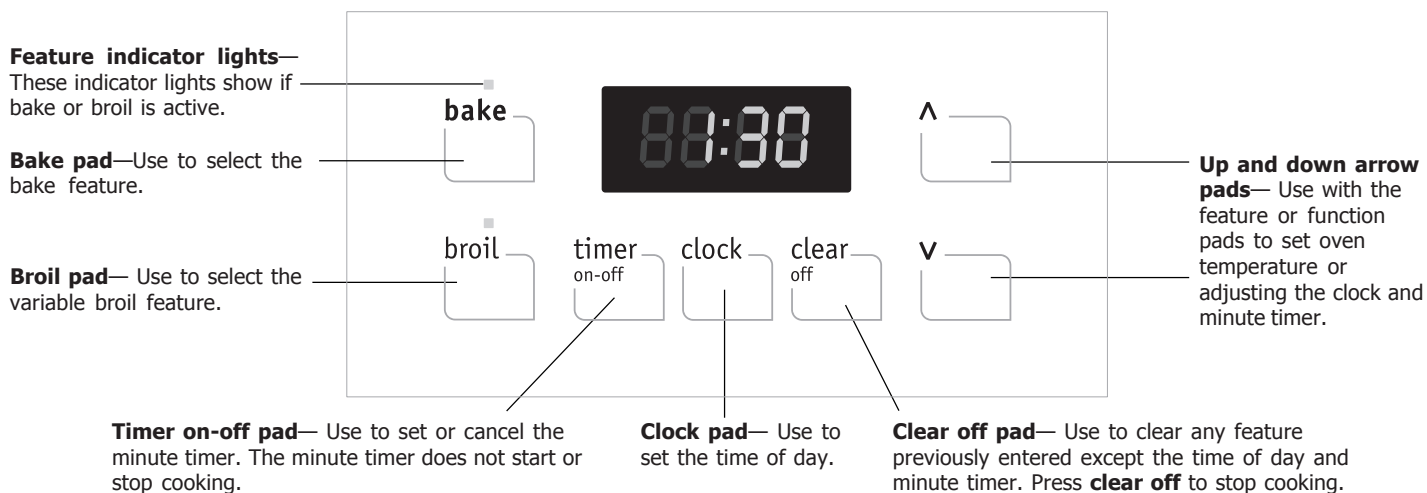

## SETTING OVEN CONTROLS

### Setting the clock

When the appliance is first plugged in or when the power supply to the appliance has been interrupted, the display will flash "12:00". It is recommended to always set the clock for the correct time of day before using the appliance.

#### To set the clock:

1. Press **clock** once (do not hold key pad down).
2. Within 5 seconds, press and hold the **^** or **v** until the correct time of day appears in the display.

### Changing the temperature display mode (°F or °C)

The electronic oven control is set to display °F (Fahrenheit) when shipped from the factory. The display may be changed to show either Fahrenheit or Celsius oven temperatures.

#### To change the temperature display mode from °F to °C (Celsius) or from °C to °F (Fahrenheit).

1. Press and hold **broil** (for 6-8 seconds) until F or C appears in the display. At this time the display will show the current temperature display mode whether set for F or C. Before proceeding read the notes below.
2. Press either **^** or **v** key pad to toggle between **F** (Fahrenheit) or **C** (Celsius) mode choices.
3. To accept the change, wait until the oven control provides the acceptance beep (See **Notes** below).
4. The display will return to the time of day with the temperature display mode changed the next time the oven is set for bake or broil.

### NOTES

- If at any time during the process of changing the temperature display mode you decide not to change the mode, press the **clear off** key pad once before the acceptance beep.
- The temperature display mode cannot be changed when **bake** or **broil** is active.

## SETTING OVEN CONTROLS

### Setting the minute timer

1. Press **timer on-off**.
2. Press the **▲** to increase the time in one minute increments. Press and hold the **▲** to increase the time in 10 minute increments. The timer can be set for any amount of time from 1 minute to 11 hours and 59 minutes.  
**Note:** If the **▼** pad is pressed first, the timer will advance to 11 hours and 59 minutes.
3. When the set time has run out, the timer will sound a 3 second tone . 0:00 will show in the display until **timer on-off** is pressed.

### To change the timer while it is in use

While the timer is active and shows in the display, press and hold the **▲** or **▼** to increase or decrease the time remaining.

### To cancel the minute timer before the set time has run out

Press **timer on-off** once .

### NOTES

- The minute timer **will not** start or stop the cooking process. It serves as an extra timer in the kitchen that will beep when the set time has run out. The minute timer can be used alone or while using any of the other oven features.
- If another feature is active when the minute timer is active, the minute timer will show in the display. To view information about other active features, press the pad for that feature.

### Setting bake

The oven can be programmed to bake at any temperature from 170°F to 550°F (77°C to 287°C). The factory preset bake temperature is 350°F (177°C).

### To set bake

1. Press **bake**. "— ——" appears in the display.
2. Within 5 seconds, press the **▲** or **▼** . The display will show "350°F (177°C)." By pressing and holding the **▲** or **▼** , the temperature can then be adjusted in 5°F increments (1°C if the control is set to display Celsius).
3. As soon as the **▲** or **▼** pad is released, the oven will begin preheating to the selected temperature. When the oven reaches the desired baking temperature, the control will beep once.

### To change the oven temperature after bake has started

1. Press **bake**. Visually check the bake temperature and that it needs to be changed.
2. Press the **▲** or **▼** pad to increase or decrease the set temperature to the desired new oven temperature.

### NOTE

To cancel baking at any time, press **clear off**.

### IMPORTANT

Dark or dull pans absorb more heat than shiny bakeware resulting in dark or overbrowning of foods. It may be necessary to reduce the oven temperature or cook time to prevent overbrowning of some foods. Dark pans are recommended for pies. Shiny pans are recommended for cakes, cookies and muffins.

## SETTING OVEN CONTROLS

### Setting broil

Use the broil feature to cook meats that require direct exposure to radiant heat for optimum browning results. When broiling always remember to arrange the oven racks while oven is still cool.

For medium done steaks, position the oven rack closer to the broil element (positions 4 or 5; Fig. 1). For well-done foods such as chicken, fish, lobster or thick cuts of meat, position the oven rack further from the broil element.

#### To set Broil

1. Arrange the oven rack while oven is still cool. Position the oven rack as needed.
2. Press **broil**. " — — " will appear in display.
3. Press and hold the **▲** or **▼** until the desired broil setting level appears in the display. Press the **▲** for **HI** broil or the **▼** for **LO** broil. Most foods may be broiled at the **HI** broil setting. Select the **LO** broil setting to avoid excess browning or drying of foods that should be cooked to the well-done stage.
4. **For optimum results, preheat oven for 5 minutes before adding food.**
5. Place the insert on the broil pan (some models; Fig. 2), then place the food on the broil pan insert.
6. Place the broiler pan and insert on the oven rack.
7. **Open the oven door** to the broil stop position when broiling.
8. Broil on one side until food is browned. Turn and broil food on 2nd side.
9. When broiling is finished press **clear off**.

#### NOTE

Always pull the oven rack out to the stop position before turning or removing the food.

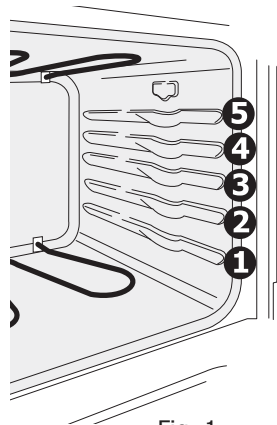

Fig. 1

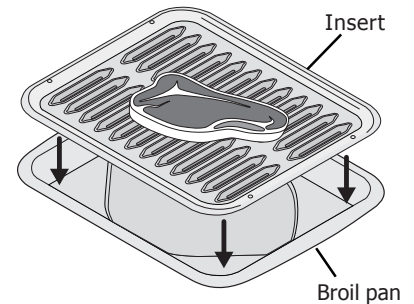

Fig. 2

#### WARNING

Should an oven fire occur, close the oven door and turn the oven OFF. If the fire continues, use a fire extinguisher. **DO NOT** put water or flour on the fire. Flour may be explosive.

#### CAUTION

- The broiler pan and the insert (some models) allows grease to drain and be kept away from the high heat of the broiler. **DO NOT** use the pan without the insert. **DO NOT** cover the insert with **aluminum foil**; the exposed grease could ignite.
- To insure proper results when broiling use **ONLY** Electrolux Home Products, Inc. approved broil pan & insert.



## SETTING OVEN CONTROLS

### Adjusting oven temperature

Your appliance has been factory calibrated and tested to ensure an accurate baking temperature. For the first few uses, follow your recipe times and temperature recommendations carefully. If you think the oven is cooking too hot or too cool for your recipe times, you can adjust the control so the oven cooks hotter or cooler than the temperature displayed.

#### To adjust oven temperature

1. Press & hold the **bake** key pad and release after the display shows the factory temperature setting of 00. If the oven temperature has been previously adjusted from the factory setting, the latest adjusted value will appear in the display instead.
2. You may increase the oven temperature in 5°F increments with each press of the **▲** key pad. You may also adjust the oven temperature downward in 5°F increments with each press of the **▼** key pad (total adjustment range is +35°F to -35°F).
3. To accept the change, wait until the oven control provides the acceptance beep (**See Notes**).
4. The oven temperature adjustment has been accepted by the oven control and the display will return to the time of day.

### Operating oven light (some models)

The interior oven light will automatically turn ON when the oven door is opened. Press the oven light switch located on the upper left control panel to turn the interior oven light ON and OFF whenever the oven door is closed.

The interior oven light is located at the upper left rear wall of the oven interior. To change the interior oven light, see "Changing the oven light" in the **Care & cleaning** section.

### Circuit protection (some models)

For protection against surcharge, a 15 amp, 120 volt circuit breaker reset is provided near the electric outlet located on top of backguard panel (See Fig. 1). If needed, press circuit breaker switch to reset.

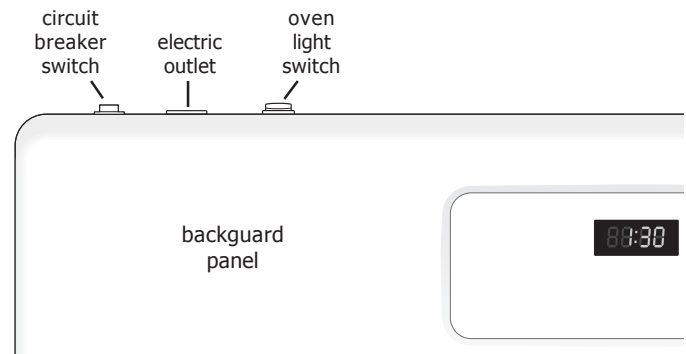

Fig. 1

### NOTES

- If at any time during the process of adjusting the oven temperature feature you decide not to make the change, press the **clear off** key pad once before the acceptance beep.
- The oven temperature adjustment feature can not be modified if **bake** or **broil** is active.
- The oven temperature adjustment may be made if your oven control has been set for °C (Celsius) **temperature display mode**. In this case each press of the **▲** or **▼** key pad will adjust in 1°C increments upward (maximum +18°C) or downward (maximum -18°C), depending on which arrow key pad is pressed.
- **DO NOT USE** oven thermometers such as those found in grocery stores to check the temperature settings inside your oven. These oven thermometers may vary as much as 20 to 40 degrees from actual temperatures.

## CARE & CLEANING

### Cleaning recommendation table

Surface type	Recommendation
<ul style="list-style-type: none"><li>• <b>Control knobs</b></li><li>• <b>Painted body parts</b></li><li>• <b>Painted decorative trim</b></li><li>• <b>Aluminum, plastic or vinyl trim pieces</b></li></ul>	<p><i>For general cleaning, use hot, soapy water and a cloth. For more difficult soils and built-up grease, apply a liquid detergent directly onto the soil. Leave on soil for 30 to 60 minutes. Rinse with a damp cloth and dry. <b>Do not</b> use abrasive cleaners on any of these materials; they can scratch. To remove control knobs, turn to the OFF position; grasp firmly and pull straight off the shaft. To replace knobs after cleaning, line up the flat sides of both the knob and the shaft; then push the knob into place.</i></p>
<ul style="list-style-type: none"><li>• <b>Control panel</b></li><li>• <b>Decorative trim</b> (some models)</li></ul>	<p><i>Before cleaning the control panel, turn all controls OFF and if needed remove any knobs from the panel. Clean using hot, soapy water and a dishcloth. <b>Be sure to squeeze excess water from the dishcloth before</b> wiping the control panel; especially when wiping around the controls area. Excess water in or around the controls may cause damage to the appliance. When rinsing, use clean water and a dishcloth and be sure to squeeze excess water from dishcloth before wiping the control panel.</i></p>
<ul style="list-style-type: none"><li>• <b>Stainless Steel</b> (some models)</li></ul>	<p>Clean heavier soils with hot, soapy water and a dishcloth. Rinse with clean water and a cloth. <b>Do not use cleaners with high concentrations of chlorides or chlorine.</b> Do not use harsh scrubbing cleaners. Only use kitchen cleaners that are especially made for cleaning stainless steel. Always be sure to wipe the cleaners off from the surface as bluish stains may occur during heating that cannot be removed.</p>
<ul style="list-style-type: none"><li>• <b>Oven interior &amp; door liner</b></li><li>• <b>Porcelain enamel broiler pan and broiler pan insert</b> (some models)</li></ul>	<p>Gentle scouring with a soapy non-abrasive scouring pad will remove most spots. Rinse with a 1:1 solution of clear water and ammonia. <i>If necessary</i>, cover difficult spots with an ammonia-soaked paper towel for 30 to 40 minutes. Rinse with clean water and a damp cloth, and then scrub with a soap-filled non-abrasive scouring pad. Rinse and wipe dry with a clean cloth. Do not allow food spills with a high sugar or acid content (milk, tomatoes, sauerkraut, fruit juices or pie filling) to remain on the surface; they may cause a dull spot even after cleaning.</p> <p>The oven interior is porcelain coated and is safe to clean using oven cleaners following manufacturer's instructions. After cleaning, remove any oven cleaner or the porcelain may become damaged during future heating. <b>Do not</b> spray oven cleaner on any electrical controls or switches. <b>Do not</b> spray or allow oven cleaner to build up on the oven temperature sensing bulb. <b>Do not</b> spray cleaner on oven door trim, door gasket, plastic drawer glides, handles or any exterior surfaces of the range.</p> <p>Clean any soils from the oven frame, the door liner outside the oven door gasket and the small area at the front center of the oven bottom. Clean with hot, soapy water. Rinse using clean water and a cloth.</p>
<ul style="list-style-type: none"><li>• <b>Oven racks</b></li></ul>	<p><b>Remove oven racks from oven before cleaning.</b> Clean by using a mild, abrasive cleaner following manufacturer's instructions. Rinse with clean water and dry.</p>
<ul style="list-style-type: none"><li>• <b>Oven door</b></li></ul>	<p>Use soap &amp; water to thoroughly clean the top, sides and front of the oven door. Rinse well. You may use a glass cleaner on the outside glass of the oven door. <b>Do not</b> immerse the door in water. <b>Do not spray or allow water or the glass cleaner to enter the door vents.</b> Do not use oven cleaners, cleaning powders or any harsh abrasive cleaning materials on the outside of the oven door.</p>
<ul style="list-style-type: none"><li>• <b>Ceramic cooktop</b></li></ul>	<p><b>Do not</b> use spray oven cleaners on the cooktop. See cooktop cleaning and maintenance in the <b>Care &amp; Cleaning</b> section.</p>

### Cooktop maintenance

#### IMPORTANT

**Consistent and proper cleaning is essential to maintaining your ceramic glass cooktop.**

Prior to using your cooktop for the first time, apply some of the glass-ceramic cooktop cleaner supplied with your new appliance. Buff with a **non-abrasive** cloth or no-scratch cleaning pad. This will make cleaning easier when soiled from cooking. The special cooktop cleaning cream leaves a protective finish on the glass to help prevent scratches and abrasions.

Sliding aluminum or copper clad bottom pans on the cooktop can cause metal markings on the cooktop surface. These marks should be removed **immediately** after the cooktop has cooled using the cooktop cleaning cream. Metal marks can become permanent if not removed prior to future use.

Cookware (cast iron, metal, ceramic or glass) with rough or dirty bottoms can **mark or scratch** the cooktop surface.

#### o not:

- Slide anything metal or glass across the cooktop.
- Use cookware with dirt or dirt build up on bottom; replace with clean cookware before using.
- Use your cooktop as a cutting board or work surface in the kitchen.
- Cook foods directly on the cooktop surface without a pan.
- Drop heavy or hard objects on the ceramic glass cooktop, they may cause it to crack.

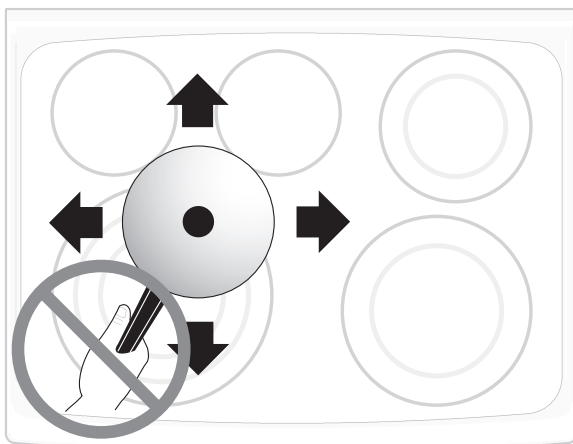

### Cooktop cleaning

#### CAUTION

Before cleaning the cooktop, be sure the controls are turned to OFF and the cooktop is COOL.

#### For light to moderate soil:

Apply a few drops of glass-ceramic cooktop cleaner directly to the cooktop. Use a paper towel or use a non-abrasive plastic type no-scratch cleaning pad to clean the entire cooktop surface. Make sure the cooktop is cleaned thoroughly, leaving no residue.

#### For heavy, burned on soil:

Apply a few drops of glass-ceramic cooktop cleaner directly to the soiled area. Rub the soiled area using a non-abrasive plastic type no-scratch cleaning pad, applying pressure as needed. Do not use the pad you use to clean the cooktop for any other purpose.

If soils remain, carefully scrape soils with a metal razor blade scraper, holding scraper at a 30 degree angle to the surface. Remove loosened soils with cooktop cleaning cream and buff surface clean.

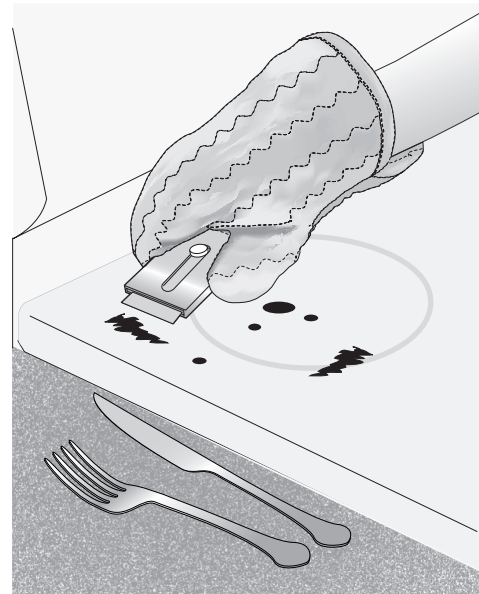

## CARE & CLEANING

### Cooktop cleaning (cont'd)

*Plastic or foods with a high sugar content:*

These types of soils need be removed immediately if spilled or melted onto the ceramic cooktop surface. Permanent damage (such as pitting of the cooktop surface) may occur if not removed **immediately**.

After turning the surface elements OFF, use a razor blade scraper or a metal spatula with a mitt and scrape the soil from the hot surface (as illustrated). Allow the cooktop to cool, and use the same method for heavy or burned on soils.

### WARNING

**DO NOT use a cooktop cleaner on a hot cooktop. The fumes can be hazardous to your health and can chemically damage the ceramic glass surface.**

#### Do not use the following on the cooktop:

- Do not use abrasive cleaners and scouring pads, such as metal and some nylon pads. They may scratch the cooktop, making it more difficult to clean.
- Do not use harsh cleaners, such as chlorine bleach, ammonia or oven cleaners, as they may etch or discolor the cooktop.
- Do not use dirty sponges, cloths or paper towels, as they can leave soil or lint on the cooktop which can burn and cause discoloration.



### IMPORTANT

Damage to the ceramic glass cooktop may occur if you use an abrasive type cleaning pad. Only use cleaning products that have been specifically designed for ceramic glass cooktops.

### Caution for aluminum use on the cooktop

- **Aluminum Foil** - Use of aluminum foil on a hot cooktop will damage the ceramic cooktop. Do not use thin aluminum cooking utensils or allow aluminum foil to touch the ceramic cooktop under ANY circumstances.
- **Aluminum utensils** - The melting point of aluminum is much lower than that of other metals. Care must be taken when aluminum pots or pans are used on the cooktop. If aluminum pans are allowed to boil dry when using the cooktop, not only will the utensil be damaged or destroyed, but it may fuse to, break or mark the ceramic glass surface, permanently damaging the cooktop surface.

### Replacing oven light

#### CAUTION

Be sure the range is unplugged and all parts are COOL before replacing oven light. Wear a leather-faced glove for protection against possible broken glass.

The interior oven light bulb is located at the upper left rear of the oven cavity.

#### To replace the oven light bulb

1. Turn electrical power off at the main source or unplug the range.
2. Replace bulb with a new 40 watt appliance bulb.
3. Turn power back on again at the main source (or plug the appliance back in).
4. The clock will then need to be reset. To reset, see "Setting the clock" in this Use & Care Guide.

## Removing and replacing the lift-off oven door

### **CAUTION**

The oven door is heavy. For safe, temporary storage, lay the oven door flat with the inside of the door facing down.

#### To remove oven door

1. Open oven door completely (horizontal with floor-Fig. 1).
2. Remove 2 screws located on the inside of the oven door liner (See **A** Fig. 2).
3. Insert the 2 screws into the door hinge holes located on the side of the hinge arm, one into each hinge (See **B** Fig. 2).
4. Close oven door until the door stops, (do not force the door to close any further). The placement of these screws should keep door open in about a 45 degree position.
5. Grasp oven door firmly on both sides and slide door up and off hinges at the same angle (See Fig. 3).
6. To clean oven door, follow the instructions provided listed in the cleaning chart under "oven door".

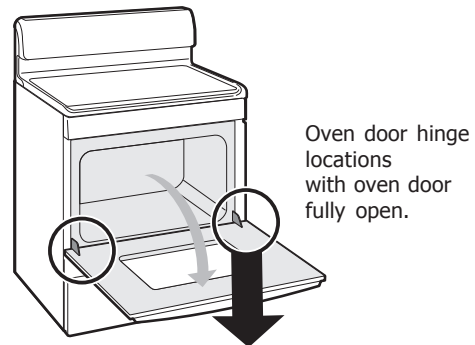

Fig. 1

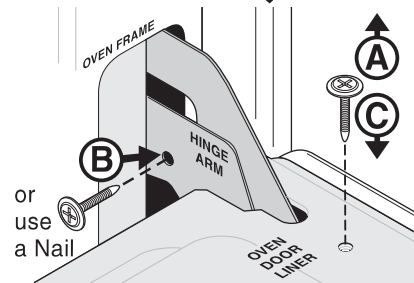

Fig. 2

#### To replace oven door

1. Be sure the hinge arms remain at the 45 degree angle position. Be sure the screws are still locking the hinge arms from moving. If the screws fall out of the hinge holes, the hinge(s) may snap back against the oven frame and could pinch fingers or chip the porcelain finish on the oven front frame.
2. Hold door at the sides near the top while resting the lower front of door on your knee. Insert the door channels at the bottom of door over the door hinges, (See Fig. 3).
3. Allow the door to slide down into the door hinges evenly at the same 45 degree angle. The hinge arms should be inserted into the bottom corners as far as they can go.
4. Open door completely (horizontal with floor) and remove both screws from holes in door hinges.
5. Reinstall the 2 screws into the door liner (See **C** Fig. 2).
6. If the door is not in alignment with the oven frame, remove door and repeat the above steps.

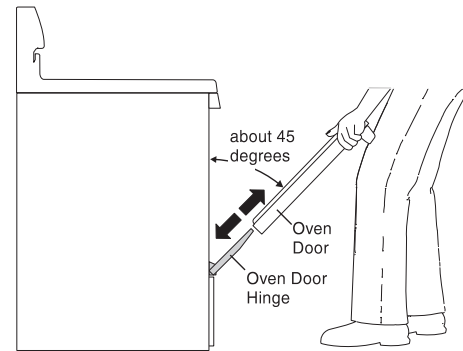

Fig. 3

### Special door care instructions - Most oven doors contain glass that can break. Read the following recommendations:

- Do not close the oven door until all the oven racks are fully in place.
- Do not hit the glass with pots, pans, or any other object.
- Scratching, hitting, jarring or stressing the glass may weaken its structure causing an increased risk of breakage at a later time.

### Cleaning under lower element (some models)

### **CAUTION**

The oven bake and broil elements may appear to have cooled after they have been turned OFF. **The elements may still be hot** and burns may occur if these elements are touched before they have cooled sufficiently.

**For models that have a visible lower bake element ONLY** - This bake element was designed to be tilted up using your hand from the front of the bake element for cleaning purposes. Remove the bottom oven rack before raising the element. Do not to raise the element more than 4 or 5 inches from the resting position.

## BEFORE YOU CALL • Solutions to common problems

Problem	Solution
Poor baking results.	<ul style="list-style-type: none"><li>• Many factors affect baking results. Make sure the proper oven rack position is used. Center food in the oven and space pans to allow air to circulate. Allow the oven to preheat to the set temperature before placing food in the oven. Try adjusting the recipe's recommended temperature or baking time. If you feel the oven is too hot or cool, see <b>Adjusting oven temperature</b> section in this Use &amp; Care Guide.</li></ul>
Appliance is not level.	<ul style="list-style-type: none"><li>• Be sure floor is level, strong &amp; stable enough to adequately support range.</li><li>• If floor is sagging or sloping, contact a carpenter to correct the situation.</li><li>• Poor installation. Place oven rack in center of oven. Place a level on the oven rack. Adjust leveling legs at base of appliance until the rack is level.</li><li>• Kitchen cabinet alignment may make range appear not level. Be sure cabinets are square &amp; have sufficient room for appliance clearance.</li></ul>
Cannot move appliance easily. Appliance must be accessible for service.	<ul style="list-style-type: none"><li>• Cabinets not square or are built in too tightly. Contact builder or installer to make appliance accessible.</li><li>• Carpet interferes with appliance. Provide sufficient space so appliance can be lifted over carpet.</li></ul>
Surface element too hot or not hot enough.	<ul style="list-style-type: none"><li>• Incorrect control setting. Be sure the correct control is ON for the element that you are attempting to use.</li></ul>
Surface element does not heat.	<ul style="list-style-type: none"><li>• Lightweight or warped pans used. Use only flat, evenly balanced, medium or heavyweight cookware. Flat pans heat better than warped pans. Cookware materials and weight of the material affect heating. Heavy &amp; medium-weight pans heat evenly. Because lightweight pans heat unevenly, foods may burn easily.</li></ul>
Entire appliance does not operate.	<ul style="list-style-type: none"><li>• The time of day is not set. The time of day <b>must</b> first be set in order to operate the oven. See <b>Setting the clock</b> in the <b>Setting Oven Controls</b> section.</li><li>• Make sure cord/plug is plugged correctly into outlet.</li><li>• Service wiring is not complete. Contact your dealer, installing agent or authorized service agent.</li><li>• Electrical power outage. Check house lights to be sure. Call your local electric company for service.</li></ul>
Oven portion of appliance does not operate.	<ul style="list-style-type: none"><li>• Be sure the oven controls are set properly for the desired cooking feature. See <b>Setting Oven Controls</b> in this manual or read the instructions "Entire appliance does not operate" in this checklist.</li></ul>
Oven light does not work.	<ul style="list-style-type: none"><li>• Be sure the light is secure in the socket. Also see <b>Changing &amp; replacing the oven light</b> section.</li></ul>



Problem	Solution
Oven smokes excessively during broiling.	<ul style="list-style-type: none"> <li>• Incorrect setting. Follow broil instructions in <b>Setting Oven Controls</b>.</li> <li>• Make sure oven door is opened to <b>broil stop position</b>.</li> <li>• Meat too close to the broil element. Reposition the oven rack to provide proper clearance between the meat &amp; the element. Preheat the broil element for searing.</li> <li>• Meat not properly prepared. Remove excess fat from meat. Cut remaining fatty edges to prevent curling, but do not cut into lean.</li> <li>• Broiler pan and insert wrong side up and grease not draining. Always place insert on the broiler pan with ribs up &amp; slots down to allow grease to drip into pan (some models).</li> <li>• Grease has built up on oven surfaces. Regular cleaning is necessary when broiling frequently. Old grease or food spatters cause excessive smoking.</li> </ul>
Flames inside oven or smoking from oven vent.	<ul style="list-style-type: none"> <li>• Excessive spillovers in oven. For example this will happen for pie spillovers or large amounts of grease left on the oven bottom. Wipe up excessive spillovers before starting oven. If flames or excessive smoke are present see <b>Setting broil</b> in the <b>Setting Oven Controls</b> section.</li> </ul>
Oven control panel beeps & displays any F code error.	<ul style="list-style-type: none"> <li>• Oven control has detected a fault or error condition. Press <b>clear off</b> to clear the display &amp; stop beeping. Try the bake or broil feature again. If the F code error repeats, remove power from appliance, wait 5 minutes and then <b>repower</b> appliance and set clock for the time of day. Try the bake or broil feature again. If the fault recurs, record fault and call for service.</li> </ul>
Scratches or abrasions on cooktop surface.	<ul style="list-style-type: none"> <li>• Coarse particles such as salt or sand between cooktop and utensils can cause scratches. Be sure cooktop surface and bottoms of utensils are clean before usage. Small scratches do not affect cooking and will become less visible with time.</li> <li>• Cleaning materials not recommended for ceramic-glass cooktop have been used. See <b>Cooktop cleaning and maintenance</b> in the <b>Care &amp; Cleaning</b> section of this Use &amp; Care Guide.</li> <li>• Cookware with rough bottom has been used. Use smooth, flat-bottomed cookware.</li> </ul>
Metal marks on the cooktop.	<ul style="list-style-type: none"> <li>• Sliding or scraping of metal utensils on cooktop surface. Do not slide metal utensils on cooktop surface. Use a ceramic-glass cooktop cleaner to remove the marks. See "Cooktop cleaning and maintenance" in the <b>Care &amp; Cleaning</b> section.</li> </ul>
Brown streaks or specks on cooktop surface.	<ul style="list-style-type: none"> <li>• Boilovers are cooked onto surface. Use razor blade scraper to remove soil. See <b>Cooktop Cleaning and Maintenance</b> in the <b>Care &amp; Cleaning</b> section.</li> </ul>
Areas of discoloration with metallic sheen on cooktop surface.	<ul style="list-style-type: none"> <li>• Mineral deposits from water and food. Remove using a ceramic-glass cooktop cleaner. Use cookware with clean, dry bottoms.</li> </ul>

## MAJOR APPLIANCE WARRANTY

Your appliance is covered by a one year limited warranty. For one year from your original date of purchase, Electrolux will pay all costs for repairing or replacing any parts of this appliance that prove to be defective in materials or workmanship when such appliance is installed, used and maintained in accordance with the provided instructions.

### Exclusions

#### This warranty does not cover the following:

1. Products with original serial numbers that have been removed, altered or cannot be readily determined.
2. Product that has been transferred from its original owner to another party or removed outside the USA or Canada.
3. Rust on the interior or exterior of the unit.
4. Products purchased "as-is" are not covered by this warranty.
5. Food loss due to any refrigerator or freezer failures.
6. Products used in a commercial setting.
7. Service calls which do not involve malfunction or defects in materials or workmanship, or for appliances not in ordinary household use or used other than in accordance with the provided instructions.
8. Service calls to correct the installation of your appliance or to instruct you how to use your appliance.
9. Expenses for making the appliance accessible for servicing, such as removal of trim, cupboards, shelves, etc., which are not a part of the appliance when it is shipped from the factory.
10. Service calls to repair or replace appliance light bulbs, air filters, water filters, other consumables, or knobs, handles, or other cosmetic parts.
11. Surcharges including, but not limited to, any after hour, weekend, or holiday service calls, tolls, ferry trip charges, or mileage expense for service calls to remote areas, including the state of Alaska.
12. Damages to the finish of appliance or home incurred during installation, including but not limited to floors, cabinets, walls, etc.
13. Damages caused by: services performed by unauthorized service companies; use of parts other than genuine Electrolux parts or parts obtained from persons other than authorized service companies; or external causes such as abuse, misuse, inadequate power supply, accidents, fires, or acts of God.

#### DISCLAIMER OF IMPLIED WARRANTIES; LIMITATION OF REMEDIES

CUSTOMER'S SOLE AND EXCLUSIVE REMEDY UNDER THIS LIMITED WARRANTY SHALL BE PRODUCT REPAIR OR REPLACEMENT AS PROVIDED HEREIN. CLAIMS BASED ON IMPLIED WARRANTIES, INCLUDING WARRANTIES OF MERCHANTABILITY OR FITNESS FOR A PARTICULAR PURPOSE, ARE LIMITED TO ONE YEAR OR THE SHORTEST PERIOD ALLOWED BY LAW, BUT NOT LESS THAN ONE YEAR. ELECTROLUX SHALL NOT BE LIABLE FOR CONSEQUENTIAL OR INCIDENTAL DAMAGES SUCH AS PROPERTY DAMAGE AND INCIDENTAL EXPENSES RESULTING FROM ANY BREACH OF THIS WRITTEN LIMITED WARRANTY OR ANY IMPLIED WARRANTY. SOME STATES AND PROVINCES DO NOT ALLOW THE EXCLUSION OR LIMITATION OF INCIDENTAL OR CONSEQUENTIAL DAMAGES, OR LIMITATIONS ON THE DURATION OF IMPLIED WARRANTIES, SO THESE LIMITATIONS OR EXCLUSIONS MAY NOT APPLY TO YOU. THIS WRITTEN WARRANTY GIVES YOU SPECIFIC LEGAL RIGHTS. YOU MAY ALSO HAVE OTHER RIGHTS THAT VARY FROM STATE TO STATE.

### If You Need Service

Keep your receipt, delivery slip, or some other appropriate payment record to establish the warranty period should service be required. If service is performed, it is in your best interest to obtain and keep all receipts. Service under this warranty must be obtained by contacting Electrolux at the addresses or phone numbers below.

This warranty only applies in the USA and Canada. In the USA, your appliance is warranted by Electrolux Major Appliances North America, a division of Electrolux Home Products, Inc. In Canada, your appliance is warranted by Electrolux Canada Corp. Electrolux authorizes no person to change or add to any obligations under this warranty. Obligations for service and parts under this warranty must be performed by Electrolux or an authorized service company. Product features or specifications as described or illustrated are subject to change without notice.

**USA**  
**1.800.944.9044**  
Electrolux Major Appliances  
North America  
10200 David Taylor Drive  
Charlotte, NC 28262



**Canada**  
**1.800.668.4606**  
Electrolux Canada Corp.  
5855 Terry Fox Way  
Mississauga, Ontario, Canada  
L5V 3E4