

Installation Instructions

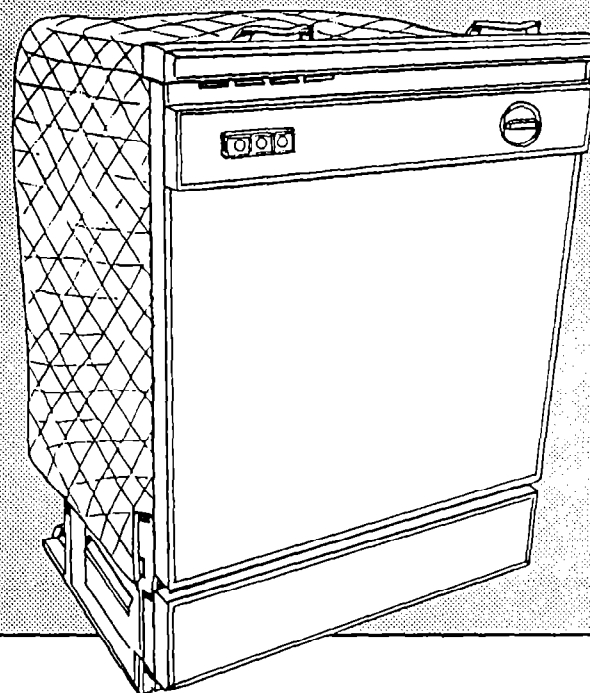

Part No. 3373987

IMPORTANT:
Read and save
these instructions.

IMPORTANT:
Installer: Leave Installation Instructions with the homeowner.
Homeowner: Keep Installation Instructions for future reference.
Save Installation Instructions for local inspector's use.

Undercounter Dishwasher

5/93

Before you start...

Proper installation is your responsibility. Make sure you have everything necessary for correct installation. It is the personal responsibility and obligation of the customer to contact a qualified installer to assure that electrical and plumbing installations meet all national and local codes and ordinances.

Proper electrical, drain and water supply lines must be available or must be installed as specified within shaded area. Plumbing and wiring should not cross in front of motor or dishwasher legs. See Electrical, Water and Drain requirements.

IMPORTANT: Observe all governing codes and ordinances.

Check location where dishwasher will be installed. The location should provide:

- Easy access to water, electricity and drainage lines.
- Convenient loading — the best position is left or right of kitchen sink.
- Opening that is square for proper dishwasher operation and appearance.
- Cabinet front that is perpendicular to floor.
- Protection so that water inlet valve and drain cannot freeze.
- 1/4" minimum clearance between motor and flooring to prevent motor from overheating.

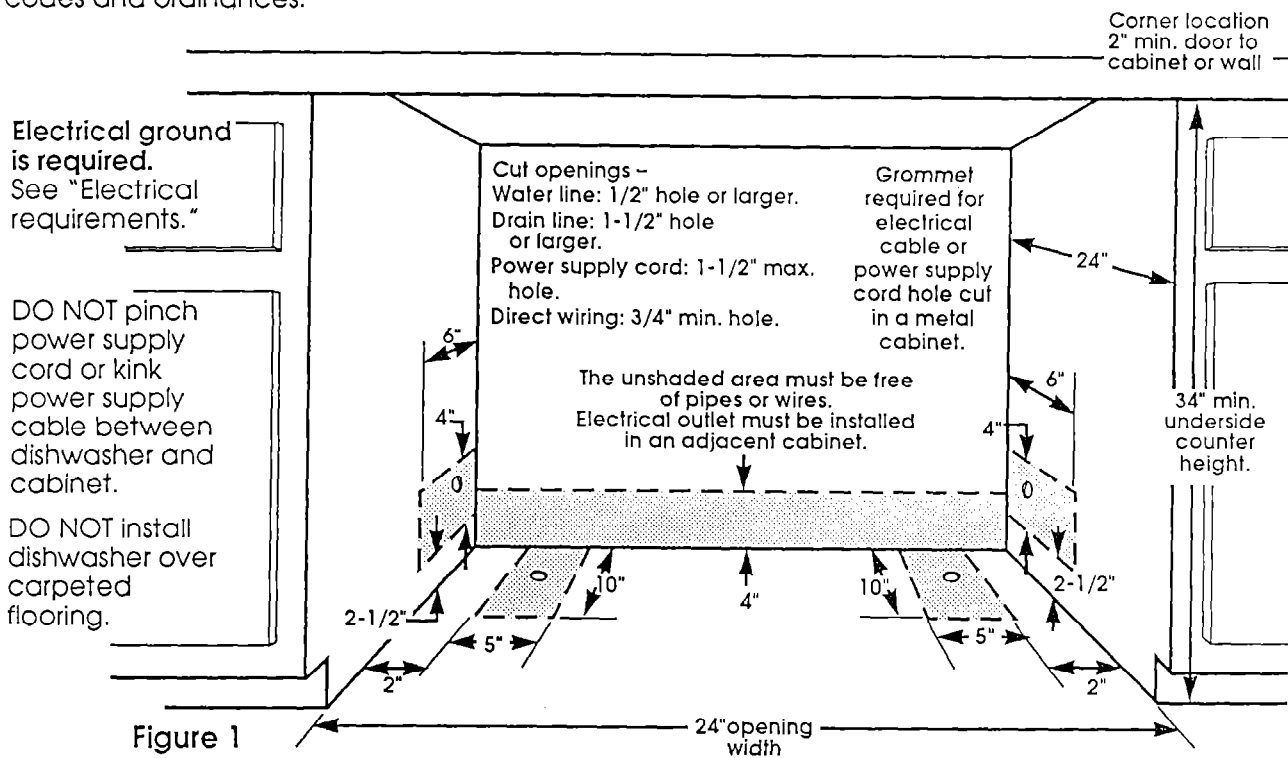

Figure 1

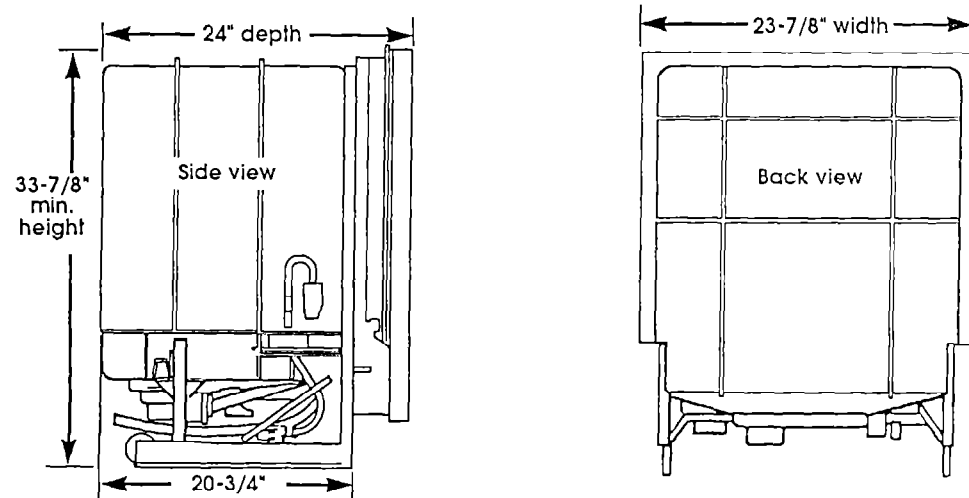

Figure 2

WARNING

Electrical Shock Hazard

- It is the personal responsibility and obligation of the customer to contact a qualified electrician to assure that the electrical installation is adequate and is in conformance with the National Electrical Code, ANSI/NFPA 70 — latest edition* and all local codes and ordinances.

Failure to follow these instructions could result in electrical shock or other personal injury.

- Electrical wiring and components must not contact any plumbing material or drain hose.
- Cabinet opening must completely enclose sides, top and back of dishwasher.

Failure to do so may result in personal injury from exposed wiring.

Personal Injury/Product Damage Hazard

Avoid opening dishwasher door before dishwasher is installed. Dishwasher, before it is installed, may tip over when door is opened, resulting in personal injury or product damage.

Copies of the standards listed may be obtained from:

*National Fire Protection Association
Batterymarch Park
Quincy, Massachusetts 02269

Read and follow the "Electrical requirements", "Water requirements" and "Drain requirements" sections before installing dishwasher.

Tools and materials needed for installation:

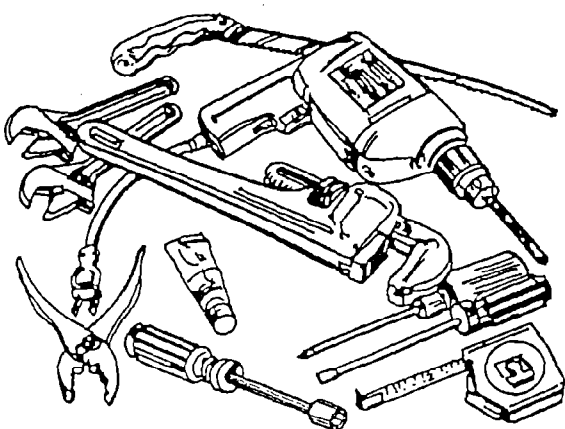

- electric drill
- Phillips screwdriver
- 2 adjustable wrenches
- pliers
- measuring tape
- flat-blade screwdriver
- pipe wrench
- keyhole saw
- tubing cutter (not shown)
- pipe-joint compound
- 5/16" and 1/4" driver or hex socket
- gloves
- 90° elbow with 3/8" N.P.T. external threads on one end. The size of the other end must fit your water supply line.

Parts supplied for installation:

- 2 drain hose clamps
- 2, No.-10 x 1/2" Phillips-head screws
- drain hose

Remove parts from bag. Check that all parts were supplied.

Electrical requirements

WARNING

Electrical Shock Hazard

- Electrical ground is required on this appliance.
 - If cold water pipe is interrupted by plastic, non-metallic gaskets or other insulating materials, Do Not use for grounding.
 - Do Not ground to a gas pipe.
 - Do Not modify the power supply cord plug. If it does not fit the outlet, have a proper outlet installed by a qualified electrician.
 - Do Not have a fuse in the neutral or grounding circuit. A fuse in the neutral or grounding circuit could result in electrical shock.
 - Do Not use an extension cord with this appliance.
 - Check with a qualified electrician if you are in doubt as to whether the appliance is properly grounded.
- Failure to follow these instructions could result in serious injury or death.

If codes permit and a separate grounding wire is used, it is recommended that a qualified electrician determine that the grounding path is adequate.

A 120-volt, 60-Hz, AC-only, 15- or 20-ampere, fused electrical supply is required. Time-delay fuse or circuit breaker is recommended. It is recommended that a separate circuit serving only this appliance be provided.

Recommended grounding method

For your personal safety, this appliance must be grounded. This appliance is equipped with a power supply cord having a 3-prong grounding plug. To minimize possible shock hazard, the cord must be plugged into a mating, 3-prong, grounding-type wall receptacle, grounded in accordance with National Electrical Code, ANSI/NFPA 70 — latest edition* and all local codes and ordinances. (See Figure 3.) If a mating wall receptacle is not available, it is the personal responsibility and obligation of the customer to have a properly grounded, 3-prong, wall receptacle installed by a qualified electrician.

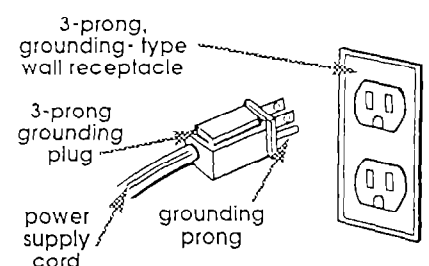

Figure 3

IF POWER CORD CANNOT BE USED...

When local codes do not permit use of a power supply cord with an undercounter dishwasher, the power supply cord must be removed and dishwasher wired directly. To direct wire this product, order kit #4317979. Electrical connections must be contained within the terminal box and meet all local codes and ordinances.

IF THE POWER SUPPLY CORD IS REMOVED, THE DISHWASHER MUST BE CONNECTED WITH COPPER WIRE ONLY.

Water Requirements

The hot water line to the dishwasher must provide between 15 -120 psi water pressure. The hot water heater should be set to deliver 140°F water temperature to the dishwasher for best results.

Use 3/8" O.D. copper tubing or 1/2" plastic tubing minimum inlet line. Dishwasher inlet valve has 3/8" N.P.T. internal pipe thread.

Drain Requirements

The drain hose MUST have a high drain loop, 20" minimum ABOVE FLOOR, to prevent backflow or water siphoning out of dishwasher during operation.

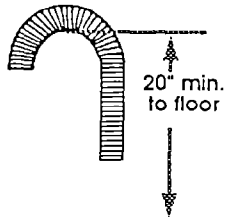

NOTE: An air gap MUST BE USED in the high drain loop if the drain hose is connected to house plumbing lower than 20" above the floor.

Drain hose, supplied, meets AHAM DW-1 test standards. Cut 1-1/2" hole in cabinet wall for drain hose. Additional drain line (a minimum of 1/2" I.D. and no longer than 20') can be used if needed.

Now start... with dishwasher in kitchen.

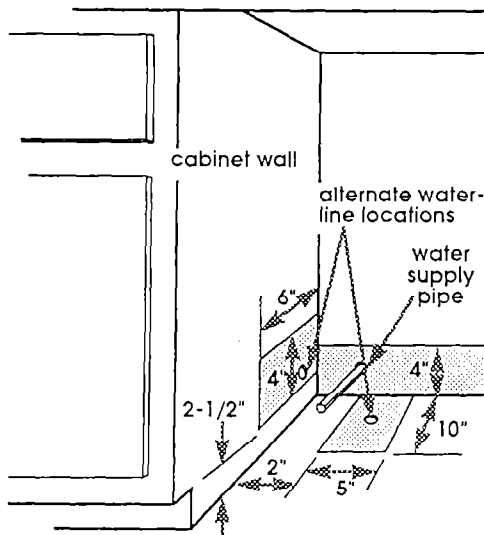

1. Rough in water line to the dishwasher cabinet opening using one of the routing methods shown. Cut 1/2" or larger hole in cabinet wall for water line.

2. Install a shutoff valve in the water line where it can be easily used.

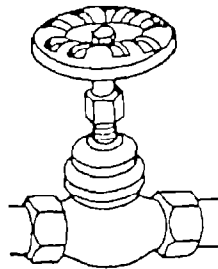

3. Flush water line into a bucket to get rid of any particles that may clog inlet valve. Turn shutoff valve to the "OFF" position.

⚠ WARNING

Electrical Shock Hazard

Disconnect electrical power at the service panel (fuse box or circuit breaker box). Failure to do so could result in serious injury or death.

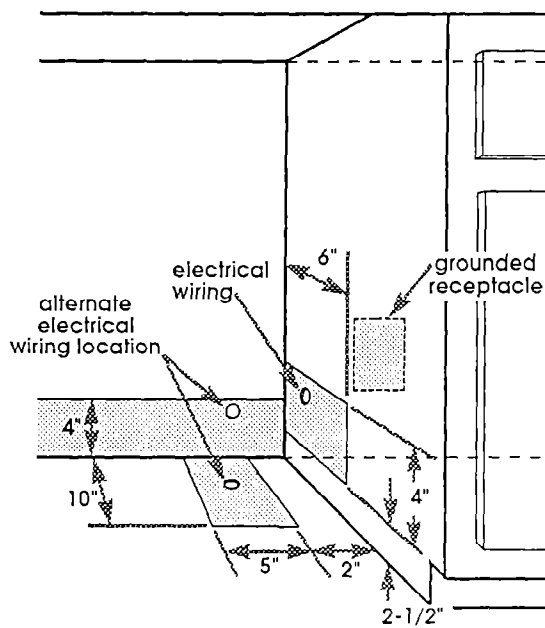

4. Cut a 1-1/2" maximum hole for power supply cord or a 3/4" minimum hole for direct wiring in the cabinet or floor for the electrical wiring to pass through. If this hole is cut in a wood cabinet, sand the hole until it is smooth. If the hole is cut in a metal cabinet, the hole **must** be covered by a grommet (Part No. 302797), available from your dealer or parts supplier.

Install wall receptacle on rear or side wall of a cabinet next to dishwasher opening as indicated by the shaded areas shown. Plug dishwasher power supply cord into this receptacle.

For direct wiring install a 3/4" U. L.-listed conduit connector to connect the flexible armored or non-metallic sheathed, copper cable (with grounding wire) to the fused disconnect, circuit breaker or junction box. Run the cable through the hole in the cabinet opening. The cable should extend 24" from the back wall.

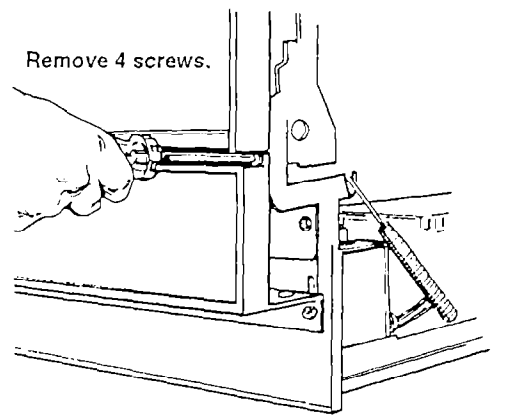

5. Remove the 4 screws attaching access panel and toe panel to dishwasher using a 1/4" hex socket, nut driver or Phillips screwdriver. Remove access panel and toe panel.

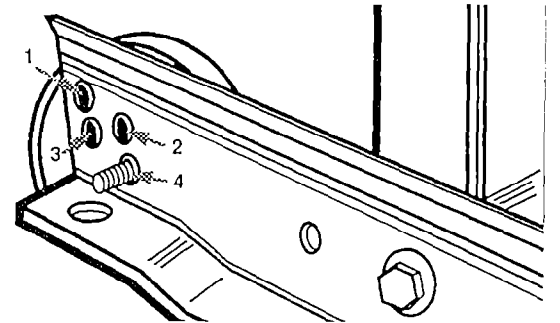

6. Measure height of cabinet opening from the front edge of the underside of cabinet opening to floor. Check chart for that height opening. Put the wheels in the required position. The dishwasher should be installed as level as possible from front to back. Loosen and then turn front levelers the number of times indicated in the chart.

Min. Cutout Height	Wheel Position (See Illustration)	Number Of Turns To Adjust Levelers
34"	1	9
34-1/8"	2	6
34-5/16"	3	3
34-1/2"	4	0

For additional height:
1. Add shims under the wheels.
2. Turn front levelers (each turn is approximately 1/16" in height).

You may have this type drain connector...

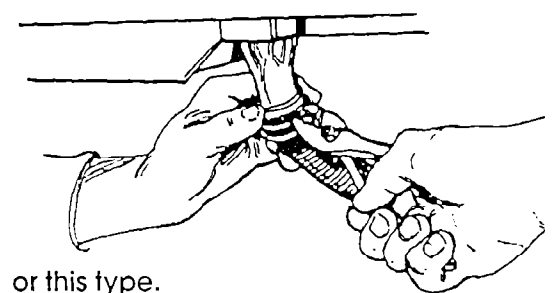

or this type.

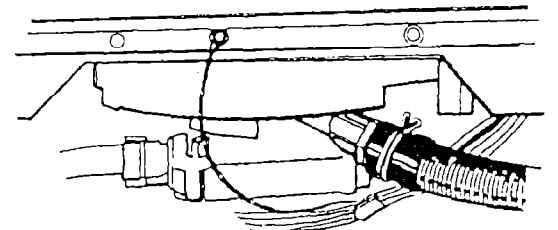

7. Put spring-type drain hose clamp over connector. Push drain hose onto connector. Use pliers to open clamp and slide clamp over drain hose and connector. Check that drain hose is secure.

If screw-type clamp is used instead of spring-type clamp, use a 5/16" nut driver to tighten drain hose securely to connector.

To minimize noise and vibration, route drain hose to avoid contact with door springs, motor, water line, cabinet or flooring. Do Not run drain hose over top of tub.

CAUTION

Floor Damage

Tilt dishwasher backwards on wheels when moving across floor. Failure to do so may cause damage to floor covering.

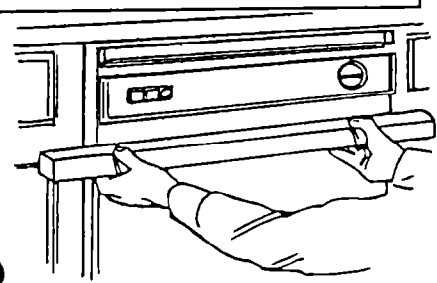

8. Latch dishwasher door. Push dishwasher into place, sliding drain hose through hole cut in cabinet opening. Do not pinch power supply cord or kink power supply cable between dishwasher and cabinet. Check that front leveling legs are firmly against the floor. Align dishwasher door with cabinet doors, so that spacing is the same on both sides.

9. Connect drain hose to an air gap or waste tee using one of the recommended or alternate methods.

Cut hose connector to fit, if needed.

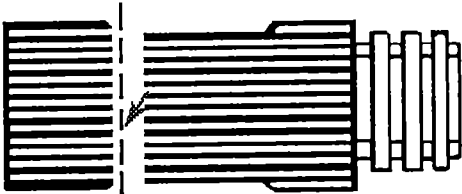

If connecting drain hose to an air gap or waste tee, cut end of drain hose as shown.

Secure drain hose with screw-type or spring-type hose clamp (clamp type varies with models.)

Do Not cut drain hose when connecting to a 7/8" disposer connector. Knock out plug from disposer inlet. Secure drain hose with hose clamp provided.

DO NOT cut ribbed section to shorten drain hose.

Recommended drain hose connection methods:

Drain hose to air gap to waste tee.

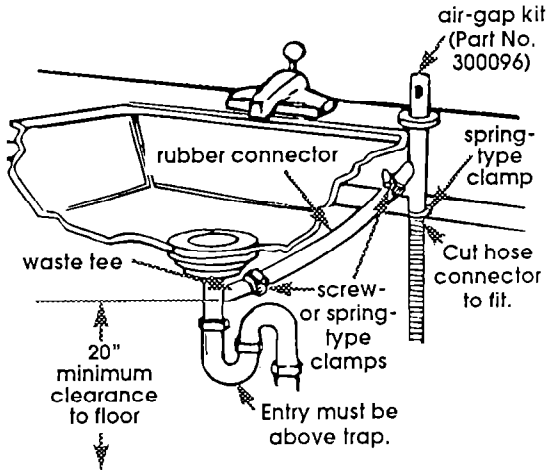

Drain hose to air gap to disposer.

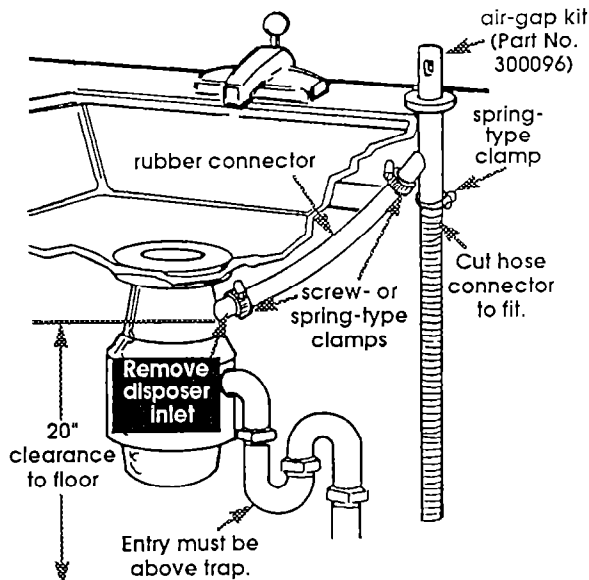

Install air gap (Part No. 300096)* according to kit instructions. If other brands of air gaps are used, they should be checked to make sure they allow for the same water flow.

Connect the air gap to a waste tee* or disposer using a rubber connector*.

Most disposers have 7/8" connectors or special connectors are available at plumbing supply houses. Be sure to remove the disposer plug before connecting the drain hose. You may need to remove disposer from sink to remove the plug.

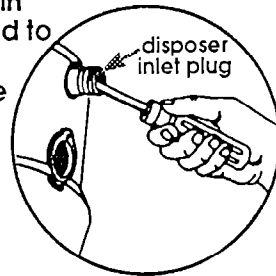

Alternate drain hose connection methods:

Drain hose to waste tee.

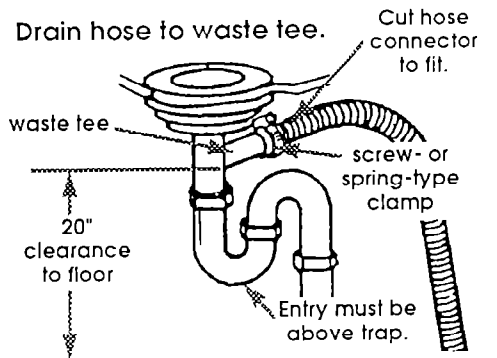

If local plumbing codes permit, dishwasher drain hose may be connected directly to waste tee*. The waste tee connection MUST be made ahead of the trap and a minimum of 20" above the floor.

Drain hose to disposer.

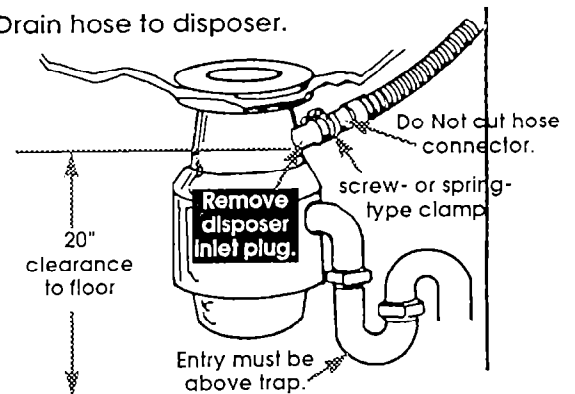

If local plumbing codes permit, dishwasher drain hose may be connected directly to disposer. Most disposers have 7/8" connectors or special connectors are available at plumbing supply houses. Be sure to remove the disposer plug before connecting the drain hose. You may need to remove disposer from sink to remove the plug.

*All parts are available through your dealer or local hardware or plumbing store.

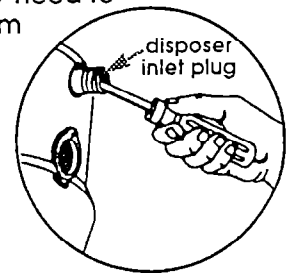

Numbers correspond to steps.

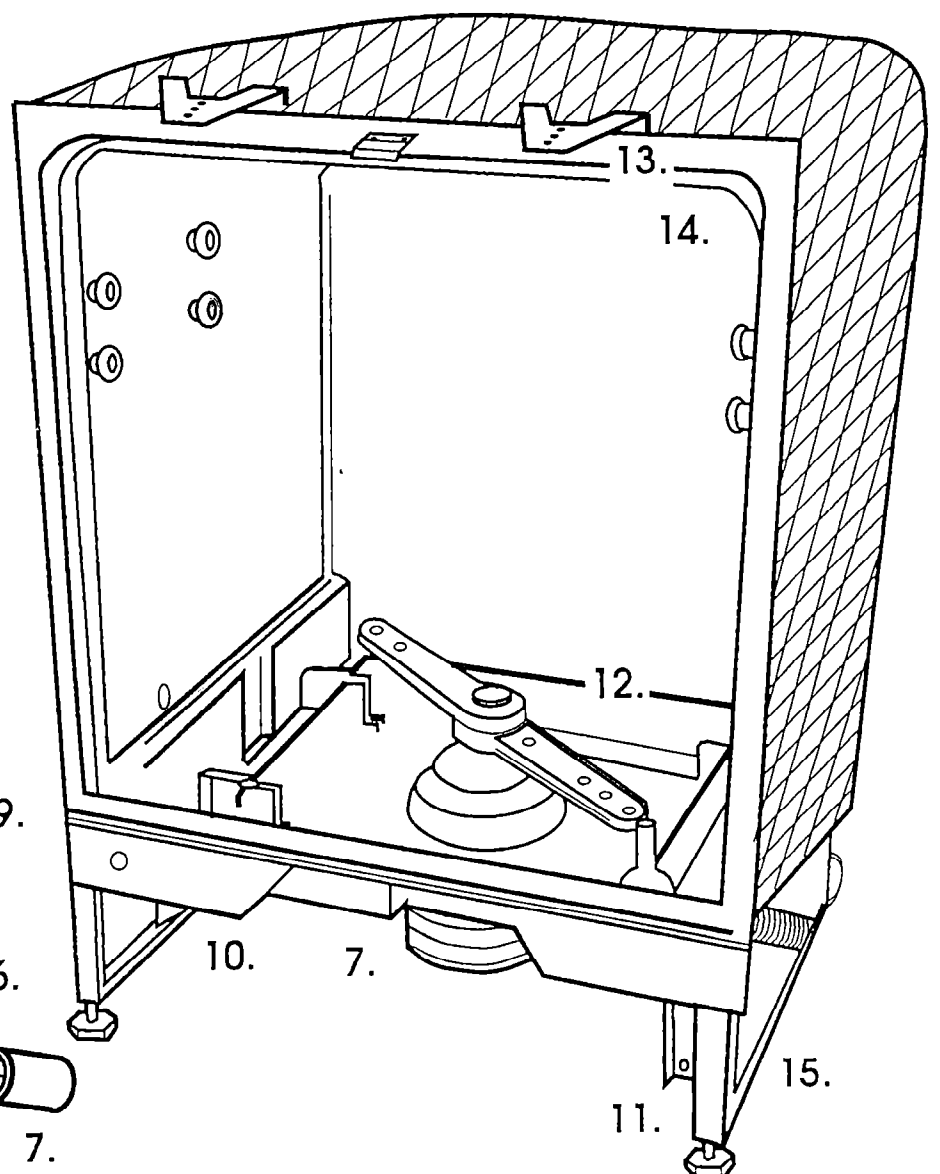
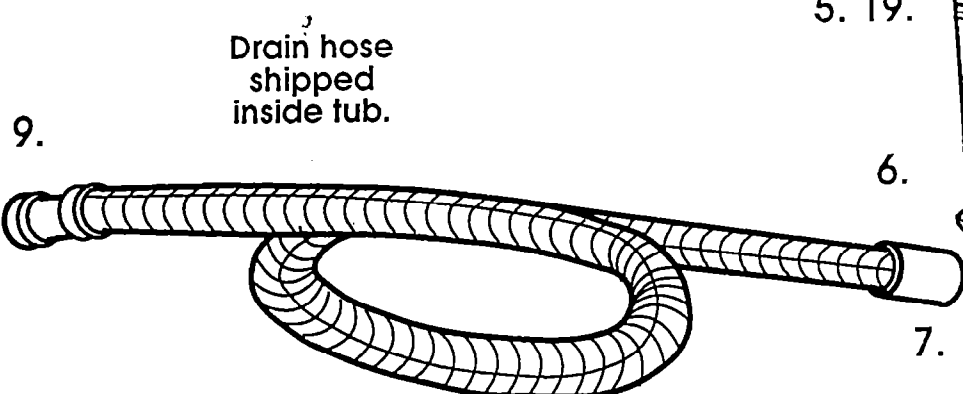

! WARNING

Product Damage

Do Not solder within 6" of plastic water inlet valves.

Failure to follow this instruction could result in product damage.

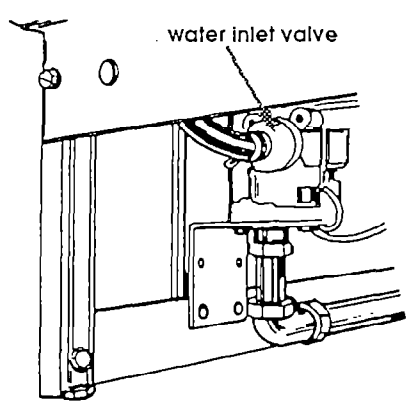

10. Connect water pipe or tubing directly to water inlet valve. Do Not run pipe or tubing across front of motor or dishwasher legs. Turn on water supply and check for leaks.

11. Check electrical requirements. Be sure you have correct electrical supply and recommended grounding method. See Panels A and B for proper connection.

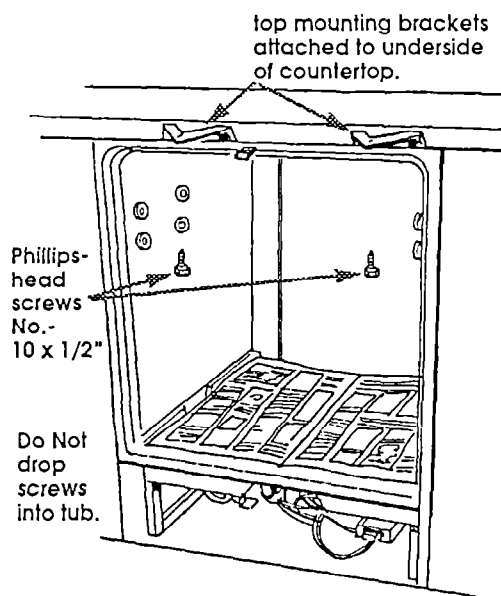

12. Open dishwasher door and remove all shipping materials. Remove bottom rack. Place a newspaper or large sheet of paper over bottom of dishwasher to protect the pump area when securing dishwasher to countertop.

! WARNING

Personal Injury/Product Damage Hazard

- The dishwasher must be secured to the countertop to keep it from tilting when door is open.
- Do Not drop screws in dishwasher tub. If screws should fall into pump, pump and motor damage may occur.

Failure to follow these instructions may result in personal injury or product damage.

13. Secure dishwasher to countertop with two, No. -10 x 1/2" Phillips-head screws from parts bag. You MUST secure dishwasher to keep it from tilting when door is opened or closed. Do Not drop screws in dishwasher tub. Remove paper from bottom of dishwasher.

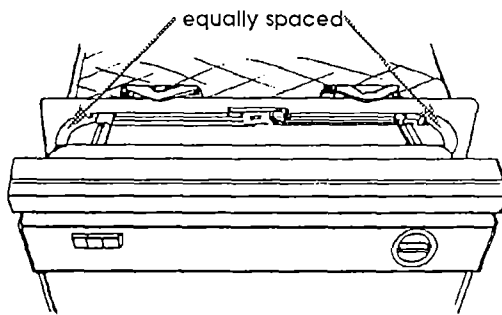

14. Open door approximately 3" and check for equal spacing between inner door and tub sides. If necessary, loosen screws that fasten dishwasher to countertop and shift tub. Tighten screws.

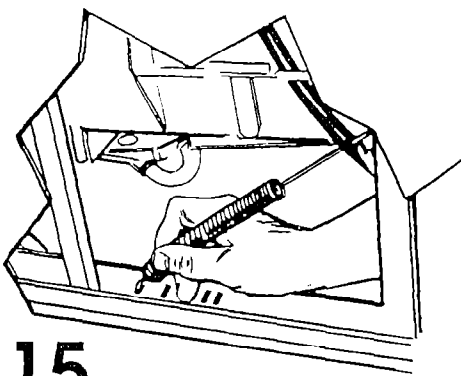

15. Check door for proper operation. Door should close easily without slamming and open with its own weight. If necessary, close door and adjust both door springs by moving spring ends to different holes in base.

16. Take a few minutes to read the Use and Care Guide to fully understand your new dishwasher.

17. Check that all parts have been installed and no steps were skipped. Check that you have all the tools you started with.

18. Turn on electric supply. Start dishwasher and allow it to complete a cycle. Check that dishwasher is working properly and that there are no water leaks.

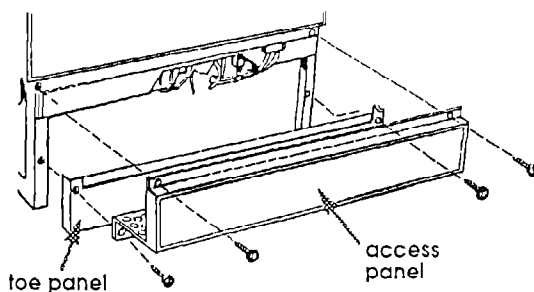

19. Replace the access panel and toe panel. The toe panel must be positioned to contact floor.

20. If changing color of door and access panel or installing custom panels, follow the "To change door panel color" and "To change access panel color" instructions, Panel D and E.

Congratulations!

You have just finished installing your new undercounter dishwasher. Keep Installation Instructions available for easy reference.

To change door panel color

NOTE: The opposite side of the door color panel is a different color.

! WARNING

Personal Injury Hazard

Wear gloves and handle panels carefully. Cut metal edges may cause personal injury or damage to other materials.

1. Push up at each end of retainer at bottom of door panel. Then pull retainer toward you. Set retainer aside.

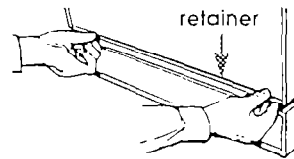

2. Slide panel(s) down to clear console. Use both hands to bow top and bottom edge of door panel(s). Remove panel(s) from door. Do Not remove spacer.

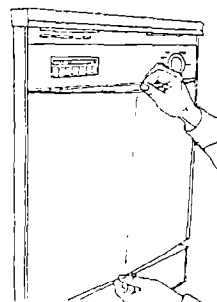

3. With desired color facing out, insert one side of door panel(s) into one side of door frame.

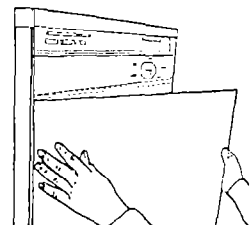

4. Bow door panel(s) and insert other side of door panel(s) into door frame.

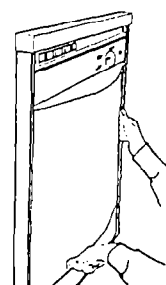

5. Push in on door panel(s) near the top and slide panel(s) and spacer up inside bottom of control console.

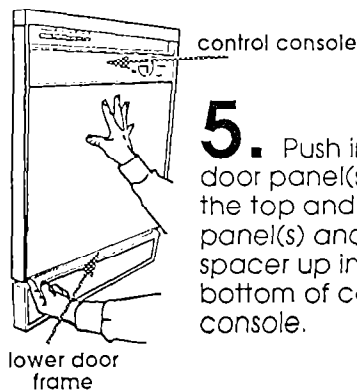

6. Lift up and hold panel(s) and spacer 1/4" above lower door frame.

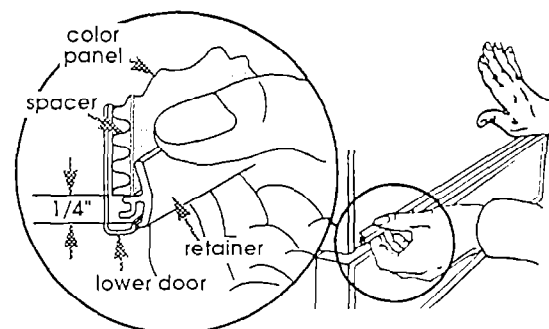

7. Insert retainer over lower edge of door frame while holding door panel(s) and spacer up.

8. Snap retainer down into place. Push down firmly along entire length of retainer to make sure retainer is secure. Slide door panel(s) down.

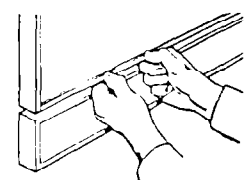

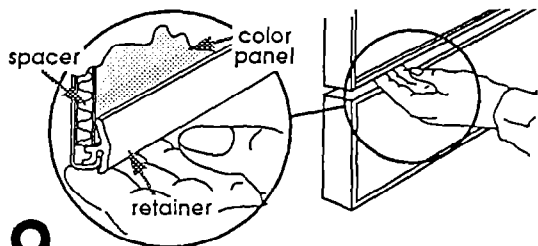

9. Important: Run fingers along bottom of retainer to check that retainer is lower than the lower door frame.

To change access color panel

(For models so equipped)

! WARNING

Personal Injury Hazard

Wear gloves and handle panels carefully.

Cut metal edges may cause personal injury or damage to other materials.

1. Push up with thumbs on each end of access panel top trim to unsnap trim. Remove top trim and set it aside.

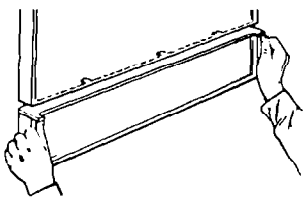

2. Carefully slide color access panel upwards and remove. Do Not remove spacer.

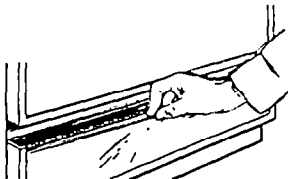

3. With desired color facing out, bow access panel and insert into access panel frame. Slide panel down into groove along bottom of access panel frame.

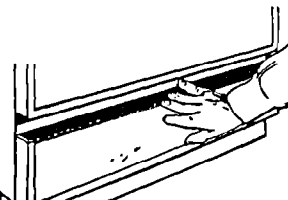

4. Line up edges of top trim with sides of access panel frame. Tilt back of trim down and slide into place. Snap front of trim down to cover top edge of access panel.

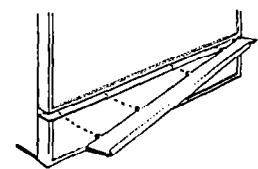

To install customized wood panels in door and access panel

Dishwasher door panel and access panel (if model is so equipped) can be customized to match wood cabinets. A standard 1/4" (7/32" actual thickness) wood panel can be used as is for customizing the door and access panels.

A door panel thicker than 7/32", requires routing the top and bottom to a 7/32" thickness.

An access panel thicker than 7/32", requires routing all four edges to a 7/32".

It is recommended that a cabinet-maker cut the customized panels because of the precise cuts required. (See Figures 4 and 5.)

Wood door panel

Cut accurately for a snug fit between door side frames. Note: Custom panel fits between, Not inside frame.

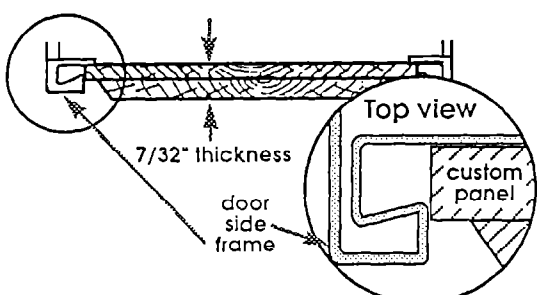

Panel E

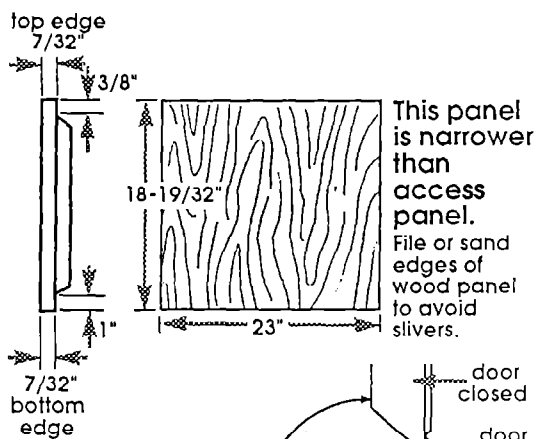
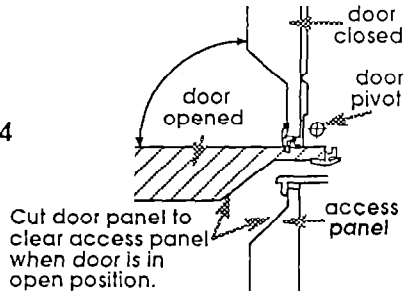

Figure 4



Cut door panel to clear access panel when door is in open position.

Heavy-duty door springs must be used if custom door panel weighs more than 4 pounds. Heavy-duty Door Springs Kit, Part No. 4318050, is available from your dealer or parts supplier. Maximum door weight is 8 pounds.

Wood access panel

This panel is wider than door panel.

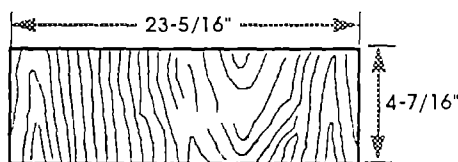

All edges routed to 7/32" thickness.

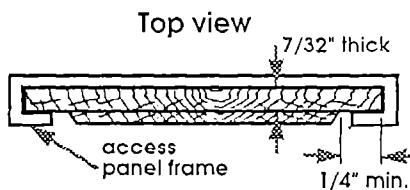

Figure 5

1. Cut wood door and access panels using specified dimensions. Make sure wood grain direction matches cabinet wood grain.

2. File or sand edges of wood panels to avoid splinters.

Dishwasher is subject to some humidity. Cover both sides and edges of wood panels with moisture-resistant sealer.

3. Push up at each end of retainer at bottom of door panel. Then pull retainer toward you. Set retainer aside.

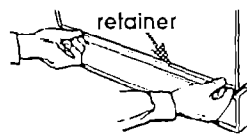

! WARNING

Personal Injury Hazard

Wear gloves and handle panels carefully.

Cut metal edges may cause personal injury or damage to other materials.

4. Slide panel(s) down to clear console. Use both hands to bow top and bottom edges of color door panel(s). Remove color panel(s) and spacer. Save color panel(s) and spacer for future use.

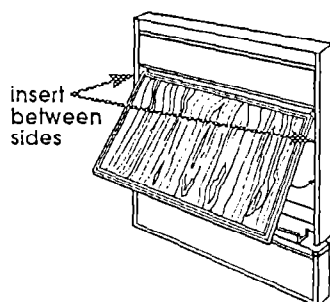

insert between sides

top of panel under control console

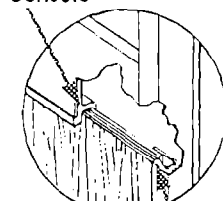

panel fits between, not inside, door frame

5. Insert top of wood door panel between sides of door frame about 3" below console. Rotate wood door panel down against dishwasher door. Slide top edge of wood door panel under bottom edge of console. Press lower portion of wood door panel in place between sides of door frame.

6. Lift up and hold wood door panel 1/4" above lower door frame.

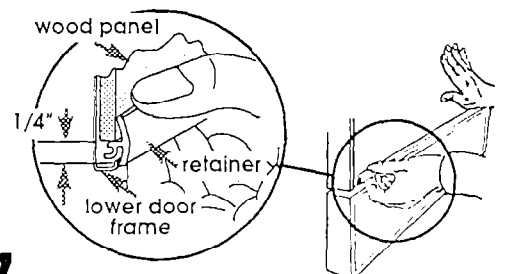

7. Insert retainer over lower edge of door frame while holding wood door panel up.

8. Snap retainer down into place. Push down firmly along entire length of retainer to make sure retainer is secure. Slide wood door panel down.

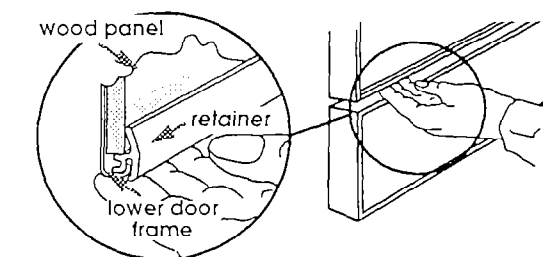
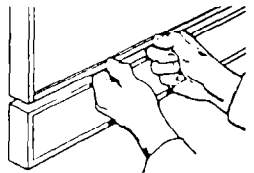

9. Important: Run fingers along bottom of retainer to check that retainer is lower than the lower door frame.

10. Check door for proper operation. Door should close easily without slamming and open with its own weight. If necessary, close door and adjust both door springs by moving spring ends to different holes in base.

11. Push up with thumbs on each end of access panel top trim to unsnap trim. Remove top trim and set it aside.

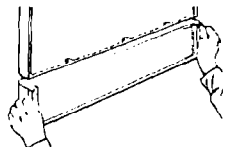

12. Carefully slide color access panel and spacer upwards and remove. Save color access panel and spacer for future use.



13. Insert wood access panel into access panel frame. Slide panel down into groove along bottom of access panel frame. It may be necessary to remove top mounting screws and tilt access panel forward to install some wood panels.

14. Line up edges of top trim with sides of access panel frame. Tilt back of trim down and slide into place. Snap front of trim down to cover top edge of wood access panel.

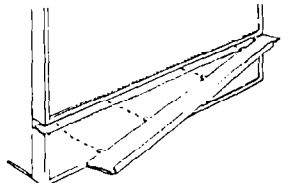

If the dishwasher is not operating properly...

Check these points:

- Is the door closed tightly and latched securely?
- Has the cycle been set correctly to start the dishwasher?
- Is the water turned on?
- Has a house fuse blown or circuit breaker tripped?
- Has electrical power been interrupted?

Note: If the motor has stopped because of overload, it will automatically reset itself within a few minutes. If after checking these points the dishwasher still does not run or complete a cycle, call for service.

If you need assistance...

Call your dealer or local authorized service company. When you call, you will need the dishwasher model number and serial number. Both numbers are located on the serial/rating plate located behind the door on the front frame of the dishwasher opening.