



Installation Instructions
30" Free-Standing Gas Range
Instrucciones de Instalacion
Estufa a Gas de 30"



 **Electrolux**

INSTALLATION INSTRUCTIONS FOR FREESTANDING GAS RANGE

INSTALLATION AND SERVICE MUST BE PERFORMED BY A QUALIFIED INSTALLER. IMPORTANT: SAVE FOR LOCAL ELECTRICAL INSPECTOR'S USE. READ AND SAVE THESE INSTRUCTIONS FOR FUTURE REFERENCE.

⚠ WARNING If the information in this manual is not followed exactly, a fire or explosion may result causing property damage, personal injury or death.

FOR YOUR SAFETY:

- Do not store or use gasoline or other flammable vapors and liquids in the vicinity of this or any other appliance.
- **WHAT TO DO IF YOU SMELL GAS:**
 - Do not try to light any appliance.
 - Do not touch any electrical switch; do not use any phone in your building.
 - Immediately call your gas supplier from a neighbor's phone. Follow the gas supplier's instructions.
 - If you cannot reach your gas supplier, call the fire department.
- Installation and service must be performed by a qualified installer, service agency or the gas supplier.



Refer to your serial plate for applicable agency certification



⚠ WARNING

- ALL RANGES CAN TIP
- INJURY TO PERSONS COULD RESULT
- INSTALL ANTI-TIP DEVICE PACKED WITH RANGE
- SEE INSTALLATION INSTRUCTIONS

Note: For appliances installed in the State of Massachusetts see page 2.

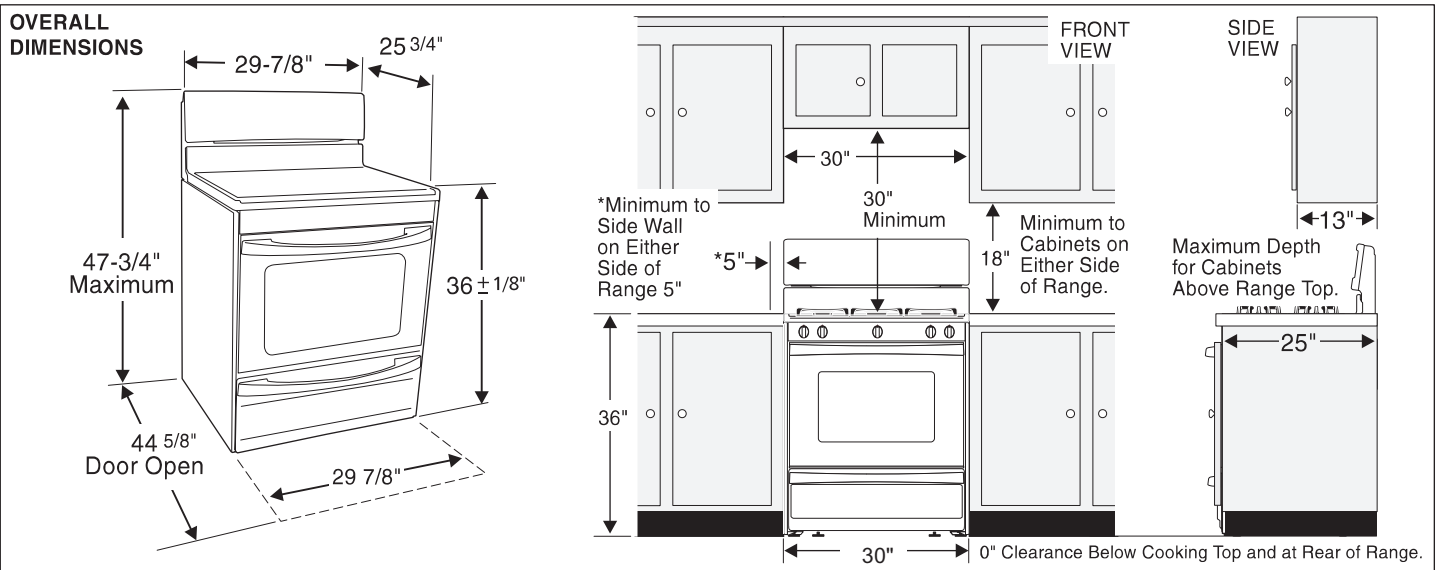

Clearances and Dimensions

1. **Location**—Check location where the range will be installed. Check for proper electrical and gas supply, and the stability of the floor.
2. **Dimensions** that are shown must be used. Given dimensions provide minimum clearance. Contact surface must be solid and level.

Note: For operation at elevations above 2000 ft., appliance rating shall be reduced at the rate of 4 percent for each 1000 ft. above sea level.

Provide Proper Fuel Type

Before Proceeding: Your appliance was preset at the factory to operate on Natural Gas only.

⚠ CAUTION DO NOT attempt to convert this range to LP/Propane settings without the proper LP/Propane conversion kit provided with the range or obtained from your dealer. Follow all instructions provided with this conversion kit.

INSTALLATION INSTRUCTIONS FOR FREESTANDING GAS RANGE

Important Notes to the Installer

1. Read all instructions contained in these installation instructions before installing range.
2. Remove all packing material from the oven compartments before connecting the gas and electrical supply to the range.
3. Observe all governing codes and ordinances.
4. Be sure to leave these instructions with the consumer.

Important Note to the Consumer

1. Keep these instructions with your Use & Care Manual for future reference.

IMPORTANT SAFETY INSTRUCTIONS

Installation of this range must conform with local codes or, in the absence of local codes, with the National Fuel Gas Code ANSI Z223.1—latest edition when installed in the United States.

When installed in a manufactured (mobile) home, installation must conform with the Manufactured Home Construction and Safety Standard, Title 24 CFR, Part 3280 [formerly the Federal Standard for Mobile Home Construction and Safety, Title 24, HUD (Part 280)] or, when such standard is not applicable, the Standard for Manufactured Home Installations, ANSI/NCSBCS A225.1, or with local codes.

This appliance has been design certified by CSA International. As with any appliance using gas and generating heat, there are certain safety precautions you should follow. You will find them in the Use & Care Manual, read it carefully.

- **Be sure your range is installed and grounded properly by a qualified installer or service technician.**
- **This range must be electrically grounded in accordance with local codes or, in their absence, with the National Electrical Code ANSI/NFPA No .70—latest edition when installed in the United States.** See Grounding Instructions on page 5.
- **Before installing the range in an area covered with linoleum or any other synthetic floor covering, make sure the floor covering can withstand heat at least 90°F above room temperature without shrinking, warping or discoloring.** Do not install the range over carpeting unless you place an insulating pad or sheet of 1/4-inch thick plywood between the range and carpeting.
- **Make sure the wall coverings around the range can withstand the heat generated by the range.**
- **Do not obstruct the flow of combustion air at the oven vent nor around the base or beneath the lower front panel of the range.** Avoid touching the vent openings or nearby surfaces as they may become hot while the oven is in operation. This range requires fresh air for proper burner combustion.
- Air curtain or other overhead range hoods, which operate by blowing a downward air flow on to a range, shall not be used in conjunction with gas ranges other than when the hood and range have been designed, tested and listed by an independent test laboratory for use in combination with each other.

⚠ WARNING Never leave children alone or unattended in the area where an appliance is in use. As children grow, teach them the proper, safe use of all appliances. Never leave the oven door open when the range is unattended.

⚠ WARNING Stepping, leaning or sitting on the doors or drawers of this range can result in serious injuries and can also cause damage to the range.

- **Do not store items of interest to children in the cabinets above the range.** Children could be seriously burned climbing on the range to reach items.
- **To eliminate the need to reach over the surface burners, cabinet storage space above the burners should be avoided.**
- **Adjust surface burner flame size so it does not extend beyond the edge of the cooking utensil.** Excessive flame is hazardous.
- **Do not use the oven as a storage space.** This creates a potentially hazardous situation.
- **Never use your range for warming or heating the room.** Prolonged use of the range without adequate ventilation can be dangerous.
- **Do not store or use gasoline or other flammable vapors and liquids near this or any other appliance.** Explosions or fires could result.
- **Reset all controls to the "off" position after using a programmable timing operation.**

FOR MODELS WITH SELF-CLEAN FEATURE:

- **Remove broiler pan, food and other utensils before self-cleaning the oven.** Wipe up excess spillage. Follow the cleaning instructions in the Use & Care Guide.
- **Unlike the standard gas range, THIS COOKTOP IS NOT REMOVABLE.** Do not attempt to remove the cooktop.

Special instructions for appliances installed in the State of Massachusetts: This appliance can only be installed in the State of Massachusetts by a Massachusetts licensed plumber or gas fitter. When using a flexible gas connector, it must not exceed 3 feet (36 inches) in length. A "T" handle type manual gas valve must be installed in the gas supply line to this appliance.

⚠ WARNING DO NOT MAKE ANY ATTEMPT TO OPERATE THE ELECTRIC IGNITION OVEN DURING AN ELECTRICAL POWER FAILURE. RESET ALL OVEN CONTROLS TO "OFF" IN THE EVENT OF A POWER FAILURE.

The electric ignitor will automatically re-ignite the oven burner when power resumes if the oven thermostat control was left in the "ON" position.

When an electrical power failure occurs during use, the surface burners will continue to operate.



During a power outage, the surface burners can be lit with a match. Hold a lighted match to the burner, then slowly turn the knob to the LITE position. Use extreme caution when lighting burners this way.

INSTALLATION INSTRUCTIONS FOR FREESTANDING GAS RANGE

Before Starting

Tools You Will Need

For leveling legs and Anti-Tip Bracket:

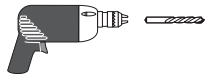
- Adjustable wrench or channel lock pliers 
- 5/16" Nutdriver or Flat Head Screw Driver 
- Electric Drill & 1/8" Diameter Drill Bit (5/32" Masonry Drill Bit if installing in concrete) 



For gas supply connection:

- Pipe wrench 

For burner flame adjustment:

- Phillips head  and blade-type screwdrivers 

Additional Materials You Will Need

- Gas line shut-off valve 
- Pipe joint sealant 
- A new flexible metal appliance conduit (1/2" NPT x 3/4" or 1/2" I.D.) must be design certified by CSA International. Because solid pipe restricts moving the range we recommend using a new flexible conduit (4 to 5 foot length) for each new installation and additional reinstallations.

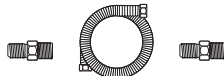

- Always use the (2) new flare union adapters (1/2" NPT x 3/4" or 1/2" I.D.) supplied with the new flexible appliance conduit for connection of the range.

Normal Installation Steps

1. Anti-Tip Bracket Installation Instructions

Important Safety Warning

To reduce the risk of tipping of the appliance, the range must be secured to the floor by properly installed anti-tip bracket and screws packed with the range. Failure to install the anti-tip bracket will allow the range to tip over if excessive weight is placed on an open door or if a child climbs upon it. Serious injury might result from spilled hot liquids or from the appliance itself.

If the appliance is ever moved to a different location, the anti-tip brackets must also be moved and installed with the appliance.

Instructions are provided for installation in wood or cement fastened to either the floor or wall. When installed to the wall, make sure that screws completely penetrate dry wall and are secured in wood or metal. When fastening to the floor or wall, be sure that screws do not penetrate electrical wiring or plumbing.

A. Locate the Bracket Using the Template - (Bracket may be located on either the left or right side of the appliance. Use the information below to locate the bracket if template is not available). Mark the floor or wall where left or right side of the range will be located. If rear of appliance is against the wall or no further than 1-1/4" from wall when installed, you may use the wall or floor mount method. If molding is installed and does not allow the bracket to fit flush against the wall, remove molding or mount bracket to the floor. For wall mount, locate the bracket by placing the back edge of the template against the rear wall and the side edge of template on the mark made referencing the side of the appliance. Place bracket on top of template and mark location of the screw holes in wall. If rear of appliance is further than 1-1/4" from the wall when installed, attach bracket to the floor. For floor mount, locate the bracket by placing back edge of the template where the rear of the range will be located. Mark the location of the screw holes, shown in template.

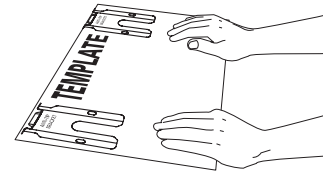

B. Drill Pilot Holes and Fasten Bracket - Drill a 1/8" pilot hole where screws are to be located. If bracket is to be mounted to the wall, drill pilot hole at an approximate 20° downward angle. If bracket is to be mounted to masonry or ceramic floors, drill a 3/16" pilot hole 1-3/4" deep. The screws provided may be used in wood or concrete material. Use a 5/16" nut-driver or flat head screwdriver to secure the bracket in place.

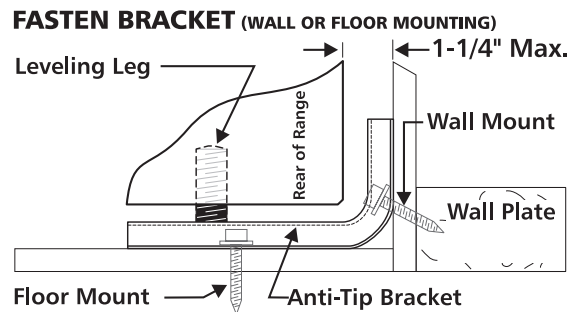

FASTEN BRACKET (FLOOR MOUNTING ONLY)

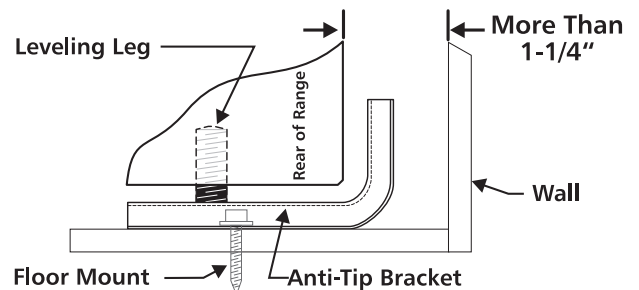

INSTALLATION INSTRUCTIONS FOR FREESTANDING GAS RANGE

C. Level & Position Appliance - Level appliance by adjusting the (4) leveling legs with a wrench. NOTE: A minimum clearance of 1/8" is required between the bottom of the appliance and the leveling leg to allow room for the bracket. Use a spirit level to check your adjustments. Slide appliance back into position. Visually check that rear leveling leg is inserted into and fully secured by the Anti-Tip Bracket by removing lower panel or storage drawer. For models with a warmer drawer or Bake-n-Warm™ Double Oven compartment, grasp the top rear edge of the range and carefully attempt to tilt it forward.

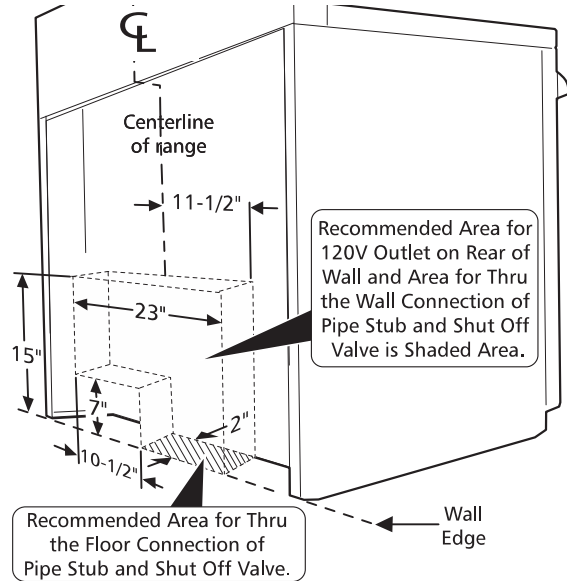
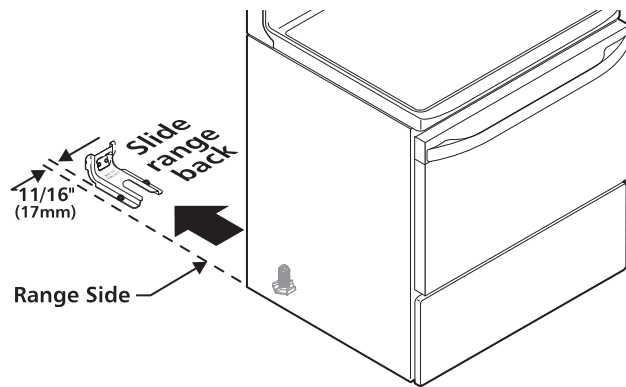

Fig. 4a

2. Provide an adequate gas supply.

This appliance is factory pre-set to operate on 4" natural gas manifold pressure. A gas pressure regulator is connected to the manifold and MUST be connected in series with the gas supply line.

Care must be taken during installation of the appliance not to obstruct the flow of combustion and ventilation air.

For proper operation, the maximum inlet pressure to the regulator should be no more than 14 inches of water column pressure. The inlet pressure to the regulator must be at least 1 inch greater than regulator manifold pressure. Examples: If regulator is set for natural gas 4 inch manifold pressure, inlet pressure must be at least 5 inches.

Leak testing of the appliance shall be conducted according to the instructions in step 4g.

The gas supply line should be 1/2" or 3/4" I.D.

3. Seal wall openings.

Seal any openings in the wall behind the appliance and in the floor under the appliance after gas supply line is installed.

4. Connect the appliance to the gas supply.

NOTE: To prevent leaks use pipe joint sealant on all male (outside) pipe threads.

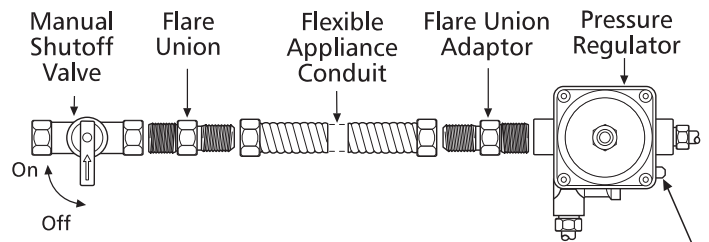

Service Shut-Off Valve Electric Ignition models only (Shown in ON Position). Be sure lever is in the "On" position when installation is complete

Fig. 4b

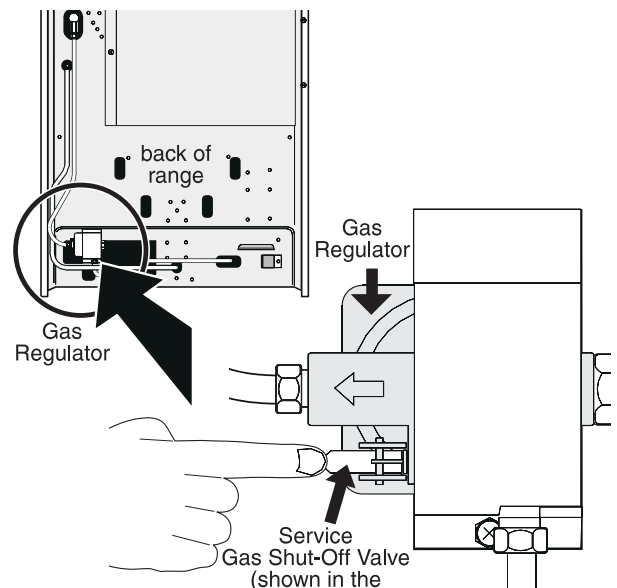

Fig. 4c

INSTALLATION INSTRUCTIONS FOR FREESTANDING GAS RANGE

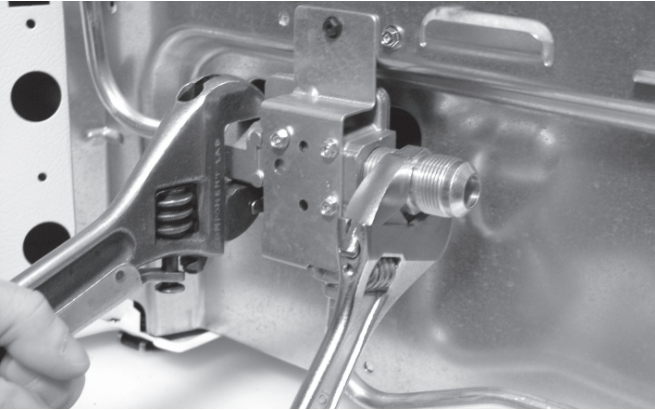

Fig. 4d

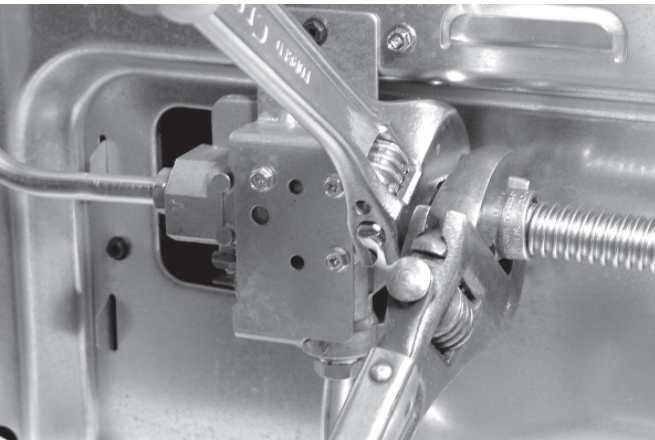

Fig. 4e



Fig. 4f

⚠ CAUTION DO NOT allow regulator to turn on pipe when tightening fittings.

- Install an external manual gas shut-off valve to gas supply line in an accessible location outside of the range. Be sure you know where and how to shut off the gas supply to the appliance.
- Install 1/2" flare union adapter to pressure regulator using **NO MORE THAN 15ft./lbs.** of torque
NOTE: Be sure to **stabilize** the left side of the pressure regulator with adjustable wrench before tightening ANY fittings to the pressure regulator (Refer to Fig. 4d).
- Tighten the gas supply fitting and/or appliance conduit to flare union on the right side of the pressure regulator using **NO MORE THAN 15ft./lbs.** of torque. Be sure to **stabilize**

the 1/2" flare union adapter with an adjustable wrench before tightening the gas supply fitting and/or appliance conduit (Refer to Fig. 4e).

- Install flare union adapter to external manual shut-off valve.
- Attach appliance conduit to flare union on shut-off valve.
- Make sure service shut-off valve on pressure regulator is in the "ON" position** (See Fig. 4f).
- Check for leaks. Turn the gas supply on to the appliance and use a liquid leak detector at all joints and conduits to check for leaks in the system.

⚠ WARNING Do not use flame to check for gas leaks.

Checking Manifold Gas Pressure

Disconnect the range and its individual shut-off valve from the gas supply piping system during any pressure testing of that system at test pressures greater than 14" of water column pressure (approximately 1/2" psig).

The appliance must be isolated from the gas supply piping system by closing its individual manual shut-off valve during any pressure testing of the gas supply piping system at test pressures equal to or less than 14" of water column pressure (approximately 1/2" psig).

If it should be necessary to check the manifold gas pressure, connect manometer (water gauge) or other pressure device to the top burner right rear orifice. Using a rubber hose with inside diameter of approximately 1/4," hold tubing down tight over orifice. Turn burner valve on.

For an accurate pressure check have at least two (2) other top burners burning. Be sure the gas supply (inlet) pressure is at least one inch above specified range manifold pressure. The gas supply pressure should never be over 14" water column. When properly adjusted for Natural Gas the manifold pressure is 4."

5. Read these electrical connection details first then connect electricity to appliance.

⚠ WARNING Before servicing, disconnect electrical supply at circuit breaker, fuse or power cord.

Electric Requirements: A dedicated, properly grounded and polarized branch circuit protected by a 15 amp. circuit breaker or time delay fuse. See serial plate for proper voltage.

Extension Cord Precautions:

Because of potential safety hazards under certain conditions, we strongly recommend against the use of any extension cord. However, if you still elect to use an extension cord, it is absolutely necessary that it be a UL listed 3-wire grounding type appliance extension cord and that the current carrying rating of the cord in amperes be equivalent to or greater than the branch circuit rating. Such extension cords are obtainable through your local service organization.

INSTALLATION INSTRUCTIONS FOR FREESTANDING GAS RANGE

⚠ WARNING PLEASE READ CAREFULLY! For personal safety, this product must be properly grounded.

Grounding Instructions

The power cord of this appliance is equipped with a 3-prong (grounding) plug which mates with a standard 3-prong grounding wall receptacle to minimize the possibility of electric shock hazard from this appliance. The customer should have the wall receptacle and circuit checked by a qualified electrician to make sure the receptacle is properly grounded and polarized.

Preferred Method

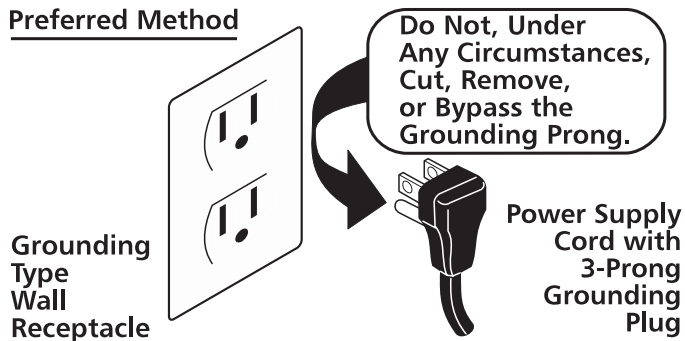

Where a standard two-prong wall receptacle is encountered, it is the personal responsibility and obligation of the customer to have it replaced with a properly grounded three-prong wall receptacle.

DO NOT, UNDER ANY CIRCUMSTANCES, CUT OR REMOVE THE THIRD (GROUND) PRONG FROM THE POWER CORD.

6. Assembly of the Surface Burner Heads, Burner Caps and Burner Grates:

It is very important to make sure that all of the Surface Burner Heads, Surface Burner Caps and Surface Burner Grates are installed correctly.

Your appliance was shipped with the burner heads and burner caps assembled in the correct locations (See Fig. 1).

Should you need to re-install the burner caps please refer to the Use & Care Guide for more information.

REMEMBER—DO NOT ALLOW SPILLS, FOOD, CLEANING AGENTS OR ANY OTHER MATERIAL TO ENTER THE GAS ORIFICE HOLDER OPENING. Always keep the Burner Caps and Burner Heads in place whenever the surface burners are in use.

Burner sizes and cooktop locations

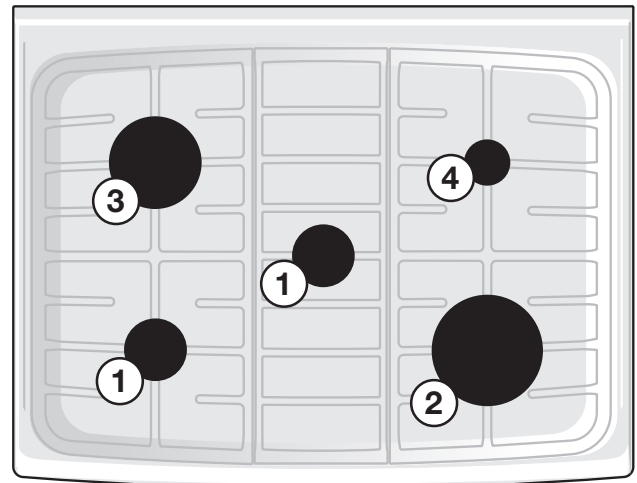

Front of cooktop

Fig. 1



1. 2 standard burners - 9,500 BTU.
2. Large burner - 16,000 BTU.
3. Large burner - 14,000 BTU.
4. Perfect Simmer burner™ - 5,000 BTU.

INSTALLATION INSTRUCTIONS FOR FREESTANDING GAS RANGE

REMEMBER — DO NOT ALLOW SPILLS, FOOD, CLEANING AGENTS OR ANY OTHER MATERIAL TO ENTER THE GAS ORIFICE HOLDER OPENING. Always keep the Burner Caps and Burner Heads in place whenever the surface burners are in use.

7. Electric Ignition Surface Burners

Operation of electric igniters should be checked after range and supply line connectors have been carefully checked for leaks and range has been connected to electric power.

- To check for proper lighting, **push in and turn** a surface burner knob **counterclockwise** to the  (**lite**) position. You will hear the igniter sparking (See Fig. 1).
- The surface burner should light when gas is available to the top burner. Purge air from supply lines by leaving knob in the  (**lite**) position until burner ignites. Each burner should light within four (4) seconds in normal operation after air has been purged from supply lines.
- Visually check that burner has lit. Once the burner lights, the control knob should be turned out of the  (**lite**) position.
- There are separate electrodes (igniters) for each burner. Try each knob separately until all burner valves have been checked.

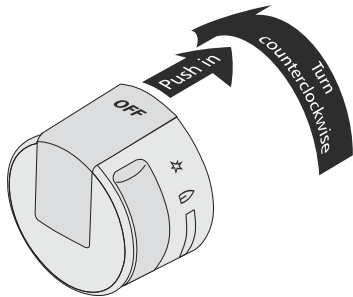

Fig. 1

8. Adjust the "LOW" Setting of Surface Burner Valve (Linear Flow Valves):

Right-hand burner only

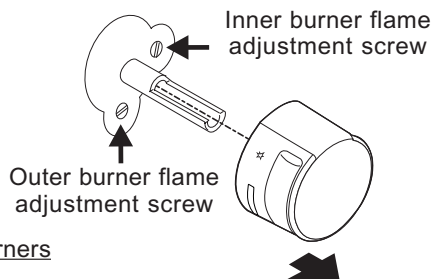

Fig. 2

All other surface burners

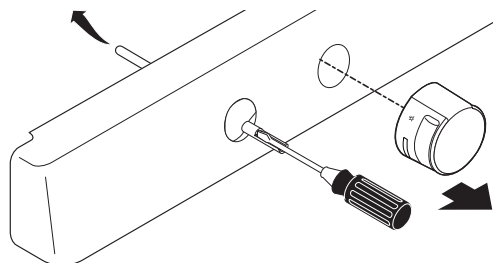



Fig. 3

Test to verify if "LO or LOW" setting should be adjusted (right front position ONLY):

- Push in and turn knob to  (**lite**) until burner ignites.
- Push in and quickly turn knob to **LOWEST POSITION**.
- If burner goes out, reset control to OFF.
- Remove the burner control knob.
- Use a thin-bladed screwdriver and adjust the inner burner flame size with the right-hand set screw (See Fig. 2). Adjust the outer burner flame size with the lower set screw (See Fig. 2). Turn counterclockwise to increase flame size. Turn clockwise to decrease flame size.

Test to verify if "LO or LOW" setting should be adjusted (all other positions):

- Follow steps a thru d above.
- Insert a thin-bladed screwdriver into the hollow valve stem and engage the slotted screw inside (Fig. 3). Flame size can be increased or decreased with the turn of the screw. Turn counterclockwise to increase flame size. Turn clockwise to decrease flame size.

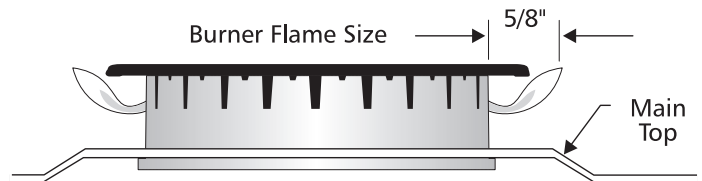

Adjust flame until you can quickly turn knob from LITE to LOWEST POSITION without extinguishing the flame. Flame should be as small as possible without going out.

Note: Air mixture adjustment is not required on surface burners.

Operation of Oven Burners & Oven Adjustments

9. Electric Ignition Burners

Operation of electric igniters should be checked after range and supply line connectors have been carefully checked for leaks and range has been connected to electric power.

The oven burner is equipped with an electric control system as well as an electric oven burner igniter. If your model is equipped with a waist-high broil burner, it will also have an electric burner igniter. These control systems require no adjustment. When the oven is set to operate, current will flow to the igniter. It will "glow" similar to a light bulb. When the igniter has reached a temperature sufficient to ignite gas, the electrically controlled oven valve will open and flame will appear at the oven burner. There is a time lapse from 30 to 60 seconds after the thermostat is turned ON before the flame appears at the oven burner. When the oven reaches the dial setting, the glowing igniter will go off. The burner flame will go "out" in 20 to 30 seconds after the igniter goes "OFF." To maintain any given oven temperature, this cycle will continue as long as the dial (or display) is set to operate.

INSTALLATION INSTRUCTIONS FOR FREESTANDING GAS RANGE

After removing all packing materials and literature from the oven:

- Set oven to BAKE at 300°F. See [Use & Care Manual](#) for operating instructions.
- Within 60 seconds the oven burner should ignite. Check for proper flame and allow the burner to cycle once. Reset controls to OFF.
- If your model is equipped with a waist-high broiler, set oven to BROIL. See [Use & Care Manual](#) for operating instructions.
- Within 60 seconds the broil burner should ignite. Check for proper flame. Reset controls to OFF.

10. Air Shutter-Oven Burner

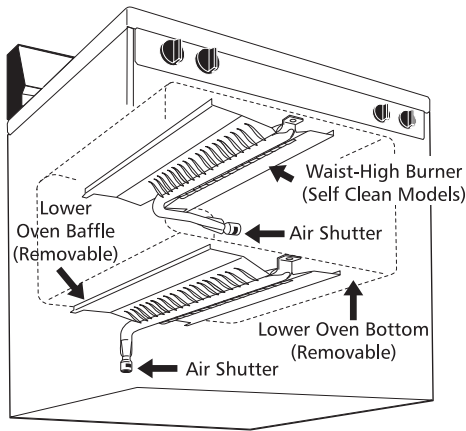

The approximate flame length of the oven burner is 1 inch (distinct inner, blue flame).

To determine if the oven burner flame is proper, remove the oven bottom and burner baffle and set the oven to bake at 300°F.

To remove the oven bottom, remove oven hold down screws at rear of oven bottom. Pull up at rear, disengage front of oven bottom from oven front frame, and pull the oven bottom out of the oven. Remove burner baffle so that the burner flame can be observed. If the flame is yellow in color, increase air shutter opening size. (See "2" in illustration below.) If the flame is a distinct blue, reduce the air shutter opening size.

To adjust loosen lock screw (see "3" illustration below), reposition air shutter, and tighten lock screw. Replace oven bottom.

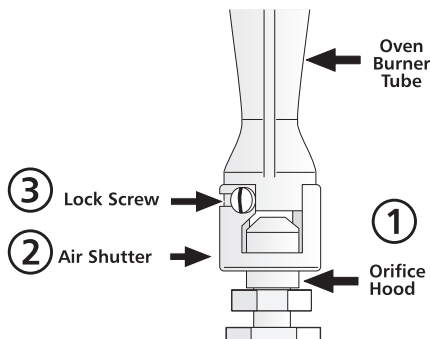

11. Air Shutter-Broil Burner

The approximate flame length of the broil burner is 1 inch (distinct inner, blue flame).

To determine if the broil burner flame is proper, set the oven to broil. If the flame is yellow in color, increase air shutter opening size. (See "2" in illustration above.) If the flame is a distinct blue, reduce the air shutter opening size.

To adjust, loosen lock screw (see "3" in illustration above), reposition air shutter, and tighten lock screw.

12. Make Sure Range is Level.

Level the range by placing a level horizontally on an oven rack. Check diagonally from front to back, then level the range by either adjusting the leveling legs or by placing shims under the corners of the range as needed.

13. After installation is complete, make sure all controls are left in the OFF position.

Care, Cleaning & Maintenance

Refer to the [Use & Care Manual](#) for cleaning instructions.

If removing the range is necessary for cleaning or maintenance, shut off gas supply. Disconnect the gas and electrical supply. If the gas or electrical supply is inaccessible, lift the unit slightly at the front and pull out away from the wall. Pull only as far as necessary to disconnect the gas and electrical supply. Finish removing the unit for servicing and cleaning. Reinstall in reverse order making sure to level the range and check gas connections for leaks. See page 3, step 1 for proper anchoring instructions.

Before You Call for Service

Read the "Before You Call" and operating instruction sections in your [Use & Care Manual](#). It may save you time and expense. The list includes common occurrences that are not the result of defective workmanship or materials in this appliance.

Refer to your [Use & Care Manual](#) for our toll-free service number and address. Please call or write if you have inquiries about your range product and/or need to order parts.

Model & Serial Number Location

For sealed burner ovens, the identification plate is located on the right-hand surface of the oven front frame at Bake-n-Warm™ Double Oven drawer.

When ordering parts for or making inquires about your range, always be sure to include the model and serial numbers and a lot number or letter from the identification plate on your range.

Your identification plate also tells you the rating of the burners, the type of fuel and the pressure the range was adjusted for when it left the factory.

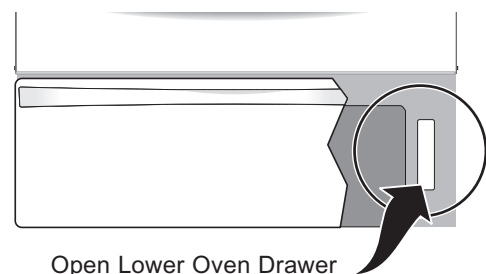

 **Electrolux**
