

**Estate**

# Use And Care

## G U I D E

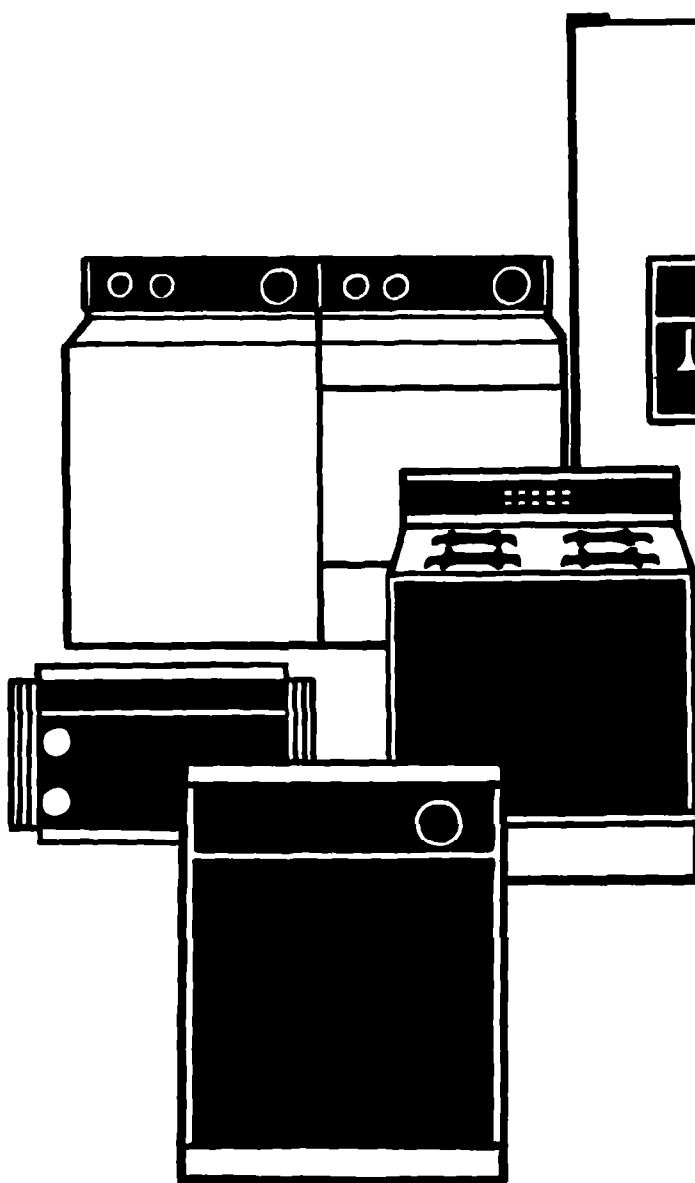

A Note To You	2
Understanding Safety	3
Knowing Your Dryer's Features	5
Operating Your Dryer	6
Caring For Your Dryer	12
Laundry Tips	16
If You Need Assistance Or Service	22
Warranty	24

**1-800-253-1301**  
Call us with questions or comments.

9-92

**ELECTRIC AND GAS DRYERS**

# A Note To You

## Thank you for buying an Estate appliance.

You have purchased a quality, *world-class* home appliance. Years of engineering experience have gone into its manufacturing. To ensure many years of trouble-free operation, we have developed this Use and Care Guide. It is full of valuable information on how to operate and maintain your appliance properly and safely. Please read it carefully. Also, please complete and mail the Ownership Registration Card provided with your appliance. This will help us notify you about any new information on your appliance.

## Your safety is important to us.

This guide contains safety symbols and statements. Please pay special attention to these symbols and follow any instructions given. Here is a brief explanation of the use of each symbol.

### **WARNING**

This symbol will help alert you to such dangers as personal injury, burns, fire and electrical shock.

### **CAUTION**

This symbol will help you avoid actions which could cause product damage (scratches, dents, etc.) and damage to your personal property.

## Our Consumer Assistance number, 1-800-253-1301, is toll-free 24 hours a day.

If you have a question concerning your appliance's operation, or if you need service, first see "If You Need Assistance Or Service" on page 22. If you need further help, call us. When calling, you will need to know your appliance's complete model number and serial number. You can find this information on the model and serial number label (see diagram on page 5). For your convenience, we have included a handy place below for you to record these numbers, the purchase date from the sales slip, and your dealer's name and telephone number. Keep this book and the sales slip together in a safe place for future reference.

**Model Number** \_\_\_\_\_

**Dealer Name** \_\_\_\_\_

**Serial Number** \_\_\_\_\_

**Dealer Phone** \_\_\_\_\_

**Purchase Date** \_\_\_\_\_

Your control panel is similar to one of the control panels on pages 9-11. Locate the control panel similar to yours and check the box below. Use the page you marked to quickly locate drying information about your model or to use for reference when calling our Consumer Assistance Center.

- Dryers with:** \_\_\_\_\_ **page**
- Cycle control knob with 2 temperature settings ..... 9
- Cycle control knob with 3 temperature settings ..... 10

- Dryers with:** \_\_\_\_\_ **page**
- Cycle control knob with an automatic cycle ..... 11

# Understanding Safety

**⚠ WARNING****Fire Hazard**

For your safety the information in this manual must be followed to minimize the risk of fire or explosion or to prevent property damage, personal injury or loss of life.

- Do Not store or use gasoline or other flammable vapors and liquids in the vicinity of this or any other appliance.
  - WHAT TO DO IF YOU SMELL GAS:
    - Do Not try to light any appliance.
    - Do Not touch any electrical switch; Do Not use any phone in your building.
    - Clear the room, building or area of all occupants.
    - Immediately call your gas supplier from a neighbor's phone.  
Follow the gas supplier's instructions.
    - If you cannot reach your gas supplier, call the fire department.
  - Never install dryer up against draperies or curtains, or on carpet.
  - Keep any and all items from falling or collecting behind the dryer.
- Installation and service must be performed by a qualified installer, service agency or the gas supplier.

## IMPORTANT SAFETY INSTRUCTIONS

### **⚠ WARNING**

To reduce the risk of fire, electrical shock, or injury to persons when using your dryer, follow basic precautions, including the following:

- Read all instructions before using your dryer.
- Do not machine wash or machine dry items cleaned, washed, soaked in, or spotted with wax, paint, gasoline, oil, and other flammable fluids. The fumes can create a fire hazard or explosion. Always hand wash and line dry items containing these materials.
- Do not allow children to operate, play with or crawl inside your dryer. Supervise children when your dryer is used near children.
- Do not reach into a dryer if the drum is moving.
- When removing from service or discarding a dryer, always remove the door to prevent accidental entrapment.
- Do not dry rubber, rubber-like, and heat sensitive materials with heat.
- Install and/or store dryer where it will not be exposed to the weather.
- Do not tamper with the controls. Failure to do so can cause serious injury, loss of life, electric shock, fire, or explosion.
- You are responsible for making sure that your dryer is installed, repaired and has parts replaced by a qualified person.
- Use only fabric softeners specifically labeled as not being harmful to the dryer.
- Do not allow lint to build-up inside the dryer or exhaust system. Cleaning should be done periodically by a qualified person.
- Clean lint screen before or after each load.
- Do not let dust, lint, paper, rags, chemicals, etc. pile up around or under the dryer.
- Dryer must be electrically grounded. See the Installation Instructions.

### **Understanding your responsibilities**

- Never operate the dryer if:
  - it is not working right (i.e. noisy, too hot).
  - it is damaged.
  - parts are missing (i.e. door latch).
  - all panels are not in place.
  - the lint screen is loose, damaged or missing.
- Unplug the power supply cord or turn off electrical power before attempting to service your dryer. Shut off gas valve if you have a gas dryer.
- Do not wash or dry items that are soiled with vegetable or cooking oil. These items may contain some oil after laundering. Due to the remaining oil, the fabric may smoke or catch fire by itself.
- You are responsible for making sure that your dryer:
  - is properly installed and leveled on a floor that can support the weight in a well-ventilated room.\*
  - is connected to the proper outlet and electrical supply (gas dryers must be vented outdoors).\*
  - is properly connected to fuel and exhaust systems.\*
  - is located in an area where the temperature is above 45°F (7°C).
  - is properly maintained.
  - is used only for jobs normally expected of home clothes dryers.
  - is not used by anyone unable to operate it properly.

\*See the Installation Instructions for complete information.

– SAVE THESE INSTRUCTIONS –

## KNOWING YOUR DRYER'S FEATURES

# Knowing Your Dryer's Features

The parts and features of your dryer are illustrated below. Become familiar with all parts and features before using your dryer.

**NOTE:** The drawings in this book may vary from your dryer model. They are designed to show the different features of all models covered by this book. Your model may not include all features.

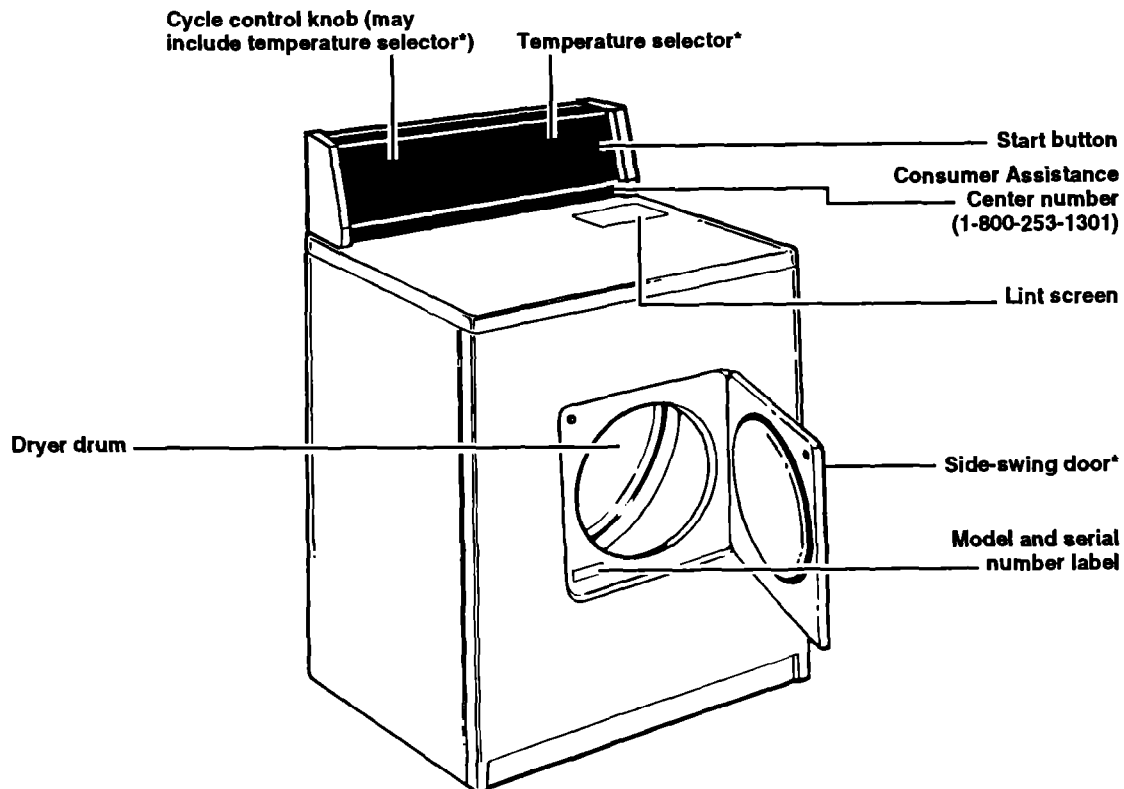

**Other feature not shown:**  
End-of-cycle signal\*  
Lint signal\*

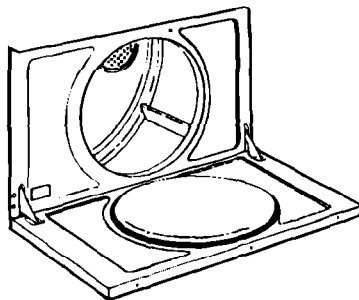

Full-width hamper door\*

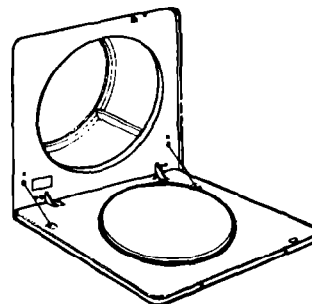

Mini-hamper door\*

\*Available on some models

# Operating Your Dryer

In This Section		Page	Page
Before starting your dryer .....	6	Selecting a cycle–time–temperature .....	7
Starting or stopping your dryer .....	6		

Operating your dryer properly assures the best drying results. This section gives you important information to help you to select a cycle, time and temperature.

## Before starting your dryer

Refer to the information below, and “Laundry Tips” for control setting, sorting and loading information.

If your dryer has a Consumer Buy Guide, remove it and place it with your Use and Care Guide.

## Starting or stopping your dryer

### Starting your dryer

Close the door and select a cycle, time, and temperature (if necessary). See pages 7-11 for additional setting information. Your dryer automatically stops when a cycle ends.

### Stopping and restarting your dryer

Open the dryer door or turn the Cycle Control Knob to OFF. Close the door; make new selections (if necessary). Push the Start Button.

**NOTE:** The Cycle Control Knob should point to an OFF area when the dryer is not in use. If the dryer is stopped before the cycle is finished, turn the Cycle Control Knob to an OFF area.

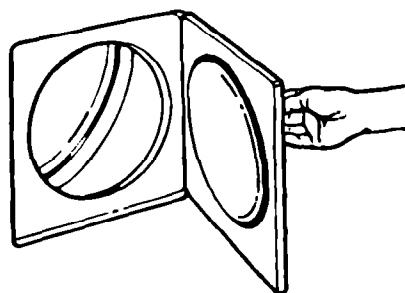

### End of cycle signal

(on some models)

The dryer sounds a signal to let you know when the cycle is finished. The signal cannot be turned off and is not adjustable (unless you have an End of Cycle Signal selector).

The signal is helpful when you are drying permanent press, synthetics and other items that should be taken out as soon as the dryer stops.

#### If your model has an End of Cycle Signal selector:

- Turn the End of Cycle Signal selector to ON if you desire a signal to let you know when the cycle is finished.
- Turn the End of Cycle Signal selector to OFF if you do not desire a signal when the cycle is finished.

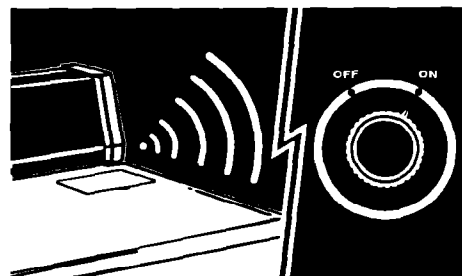

## Selecting a cycle–time–temperature

The information you need to make correct drying decisions is given in this section.

- Pages 7 and 8: Use these pages to find additional information about drying cycles that may be on your model.
- Pages 9 to 11: Find the page that has a control panel similar to yours. Use this page to guide you when making drying selections.

**Your dryer has a Cycle Control Knob with temperatures built-in:**

1. Select a cycle, time, and temperature by turning the Cycle Control Knob either way.
2. Stop when the indicator on the knob's outer ring points to the cycle, time, and temperature you want.

**Changing a selection:**

1. Turn the Cycle Control Knob to point to a new setting.
2. Push the Start Button, if necessary.

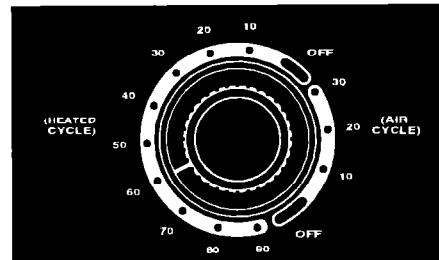

Cycle control knob with 2 temperature selections

### Using the Damp Dry cycle

(on some models)

Use this cycle to dry damp items that do not require an entire drying cycle, or to dry items to damp level. Two examples are heavy cottons, such as jeans, which you do not want to become stiff, or cotton clothes which are easier to press when damp.

1. Set Cycle Control Knob on DAMP DRY.
2. Push the Start Button.

The dryer tumbles the load with heat, then without heat for the last few minutes.

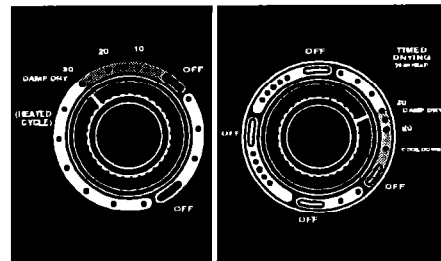

Shaded areas show location of damp dry cycle

### Using the Wrinkle Free cycle

(on some models)

The Wrinkle Free cycle removes wrinkles from clothing that has been packed in a suitcase or closet, and from items not removed from the dryer at the end of a cycle.

1. Set Cycle Control Knob on WRINKLE FREE.
2. Push the Start Button.

The dryer tumbles the load with heat, then without heat for the last few minutes. For best results, put only a few items at a time in this cycle. As soon as the dryer stops, put the items on hangers or fold them.

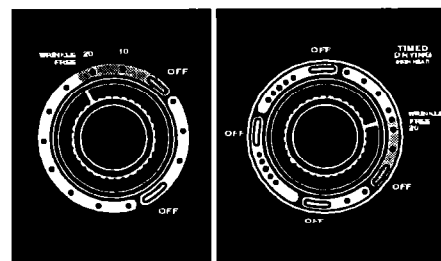

Shaded areas show location of wrinkle free cycle

# OPERATING YOUR DRYER

## Using the automatic cycles

(on some models)

Your automatic control senses the dryness of the load and automatically shuts off when the selected dryness is reached. For the first few loads:

1. Set the cycle Control Knob to point to the center dot in your automatic cycle.
2. Select a heat setting to match your load.
3. Feel the dried items when the dryer stops.

**If the items are drier than you like, select a setting closer to LESS DRY the next time you dry a similar load.**

**If items are not as dry as you like, select a setting closer to VERY DRY the next time you dry a similar load.**

The Cycle Control Knob will not move until the load is almost dry or the cool-down portion of the cycle has been reached. After the cool down is complete, the Cycle Control Knob automatically moves to an OFF area and the tumbling stops.

**NOTE:** Your model will not look exactly like the illustration.

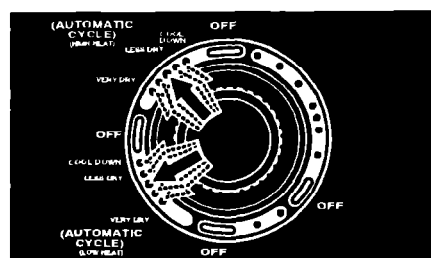
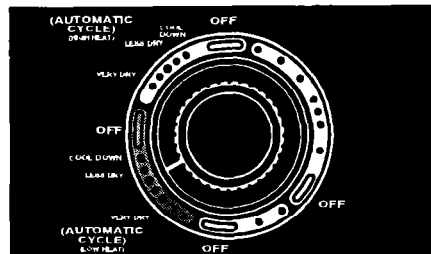

## Using the air cycle (no heat)

### ⚠ WARNING

#### Fire Hazard

Do not dry plastic or rubber items with heat. Use the air cycle, or line dry.

Failure to do so could result in fire or damaged items.

The dryer does not heat when the Cycle Control Knob is set in the air cycle. This cycle can be used to fluff or air dry bedding, plastic tablecloths, foam pillows, sneakers, etc.

1. Turn the Cycle Control Knob to the number of minutes you want in the air cycle. Refer to the chart below for suggested times.
2. Push the Start Button.

**NOTE:** Repeat steps above if more time is needed to dry items.

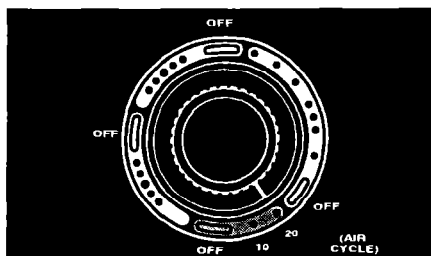
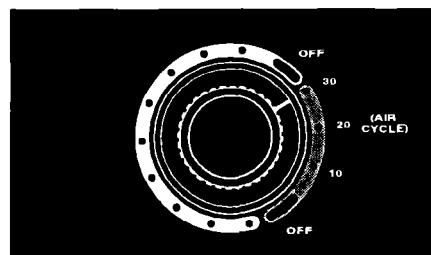

TYPE OF LOAD	CYCLE AND TIME
<b>RUBBER, PLASTIC, HEAT-SENSITIVE FABRICS</b>	<b>Air</b>
Foam Rubber—Pillows, bras, stuffed toys	20-30 min
Plastic—Shower curtains, tablecloths	20-30 min
Rubber-backed rugs	40-50 min
Olefin, Polypropylene, Sheer nylon	15-20 min



# OPERATING YOUR DRYER

## Cycle control knob with 2 temperature choices

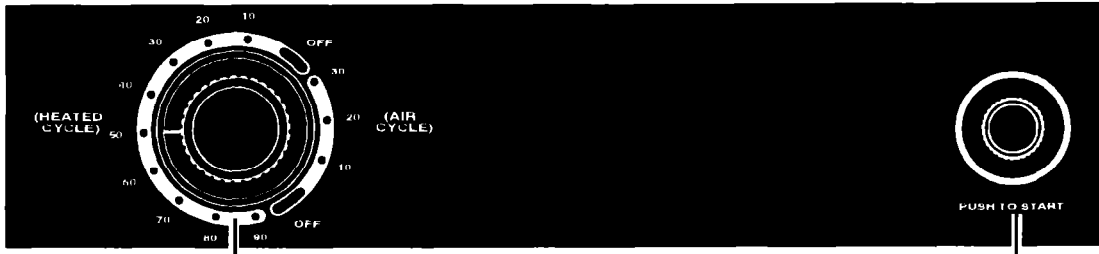

Cycle control knob and temperature selector

Start button

If your dryer has a Cycle Control Knob with 2 temperature settings (heat, air), refer to the chart below and the chart on page 8 for cycle information.

### Using your heated cycle

Your heated cycle provides the special care that cottons, permanent press and some synthetic fabrics need. The cycle consists of a timed period of heated drying and a brief cool-down period. During the cool down, the load

tumbles without heat. This helps keep wrinkles from setting in and makes the load easier to handle.

**NOTE:** To help reduce wrinkling, remove the load from the dryer as soon as tumbling stops. This is important for permanent press, knits and synthetic fabrics. Do not overdry. Overdrying can cause shrinkage, static cling, and damage some fabrics.

TYPE OF LOAD	CYCLE AND TIME	
	Heated	Air
<b>COTTONS AND LINENS</b> Extra Heavy—Bedspreads, mattress pads, quilts Heavyweight—Towels, jeans, corduroys, work clothes Mediumweight—Sheets, cotton underwear, diapers Lightweight—Batistes, organdies, lingerie	70-80 min 50-60 min 40-50 min 30-40 min	
<b>PERMANENT PRESS, SYNTHETICS AND BLENDS</b> Heavyweight—Work clothes, jackets, raincoats Mediumweight—Shirts, play clothes, sheets, slacks Lightweight—Lingerie, blouses, dresses	40-50 min 30-40 min 20-30 min	
<b>KNITS</b> Heavyweight—Cottons, rayons, blends, T-shirts, slacks, shirts Mediumweight—Synthetics (polyester, acrylic, etc.), dress slacks, skirts, sweaters Lightweight—Synthetics (polyester, acrylic, etc.) and blends, lingerie, blouses, dresses	40-50 min 30-40 min 20-30 min	
<b>DELICATE FABRICS</b> Sheer curtains (2 or 3 panels), gauze, lace, etc.		20-30 min

# OPERATING YOUR DRYER

## Cycle control knob with 3 temperature choices



Cycle control knob and temperature selector

End of cycle signal Start button

If your dryer has a Cycle Control Knob with 3 temperature settings (high, low, no heat), refer to the chart below and the chart on page 8 for cycle information.

Loads tumble without heat during the last few minutes of all heated cycles. This makes a load easier to handle and helps keep wrinkles from setting in.

### Using your timed drying (high heat) cycle

Your Timed Drying (high heat) cycle provides the special care that cottons, permanent press and some synthetic fabrics need.

### Using your timed drying (low heat) cycle

Your Timed Drying (low heat) cycle helps provide special care for drying some synthetics, knits and delicate fabrics.

**NOTE:** To help reduce wrinkling, remove the load from the dryer as soon as tumbling stops. This is important for permanent press, knits and synthetic fabrics. Do not overdry. Overdrying can cause shrinkage, static cling, and damage some fabrics.

TYPE OF LOAD	TIMED DRYING	
	(High heat)	(Low heat)
<b>COTTONS AND LINENS</b> Extra Heavy—Bedspreads, mattress pads, quilts Heavyweight—Towels, jeans, corduroys, work clothes Mediumweight—Sheets, cotton underwear, diapers Lightweight—Batistes, organdies, lingerie	70-80 min 50-60 min 40-50 min	30-40 min
<b>PERMANENT PRESS, SYNTHETICS AND BLENDS</b> Heavyweight—Work clothes, jackets, raincoats Mediumweight—Shirts, play clothes, sheets, slacks Lightweight—Lingerie, blouses, dresses	40-50 min 30-40 min	20-30 min
<b>KNITS</b> Heavyweight—Cottons, rayons, blends, T-shirts, slacks, shirts Mediumweight—Synthetics (polyester, acrylic, etc.), dress slacks, skirts, sweaters Lightweight—Synthetics (polyester, acrylic, etc.) and blends, lingerie, blouses, dresses	40-50 min	30-40 min 20-30 min
<b>DELICATE FABRICS</b> Sheer curtains (2 or 3 panels), gauze, lace, etc.		15-20 min

## OPERATING YOUR DRYER

### Cycle control knob with an automatic cycle



Cycle control knob and temperature selector

End of cycle signal Start button

If your dryer has an automatic cycle and three temperature choices (high, low, no heat), refer to the chart below and the chart on page 8 for cycle information.

Loads tumble without heat during the last few minutes of all heated cycles. This makes a load easier to handle and helps keep wrinkles from setting in.

#### Using your automatic cycles (high and low heat settings)

Use your automatic cycles (high heat or low heat) to automatically dry any load. The chart below suggests the cycle to use for various types of loads.

See page 8 for more information about how to use your automatic cycle.

#### Using your timed drying (high heat) cycle

Use your Timed Drying cycle for any load you want to dry by time. This cycle is designed for small loads or large bulky items.

**NOTE:** To help reduce wrinkling, remove the load from the dryer as soon as tumbling stops. This is important for permanent press, knits and synthetic fabrics. Do not overdry. Overdrying can cause shrinkage, static cling, and damage some fabrics.

TYPE OF LOAD	Automatic cycle
<b>COTTONS AND LINENS</b> Extra Heavy—Bedspreads, mattress pads, quilts Heavyweight—Towels, jeans, corduroys, work clothes Mediumweight—Sheets, cotton underwear, diapers Lightweight—Batistes, organdies, lingerie	HIGH HEAT HIGH HEAT HIGH HEAT LOW HEAT
<b>PERMANENT PRESS, SYNTHETICS AND BLENDS</b> Heavyweight—Work clothes, jackets, raincoats Mediumweight—Shirts, play clothes, sheets, slacks Lightweight—Lingerie, blouses, dresses	HIGH HEAT HIGH HEAT LOW HEAT
<b>KNITS</b> Heavyweight—Cottons, rayons, blends, T-shirts, slacks, shirts Mediumweight—Synthetics (polyester, acrylic, etc.), dress slacks, skirts, sweaters Lightweight—Synthetics (polyester, acrylic, etc.) and blends, lingerie, blouses, dresses	HIGH HEAT LOW HEAT LOW HEAT
<b>DELICATE FABRICS</b> Sheer curtains (2 or 3 panels), gauze, lace, etc.	LOW HEAT

# Caring For Your Dryer

In This Section	
Maintenance—every load .....	Page 12
Maintenance—as needed .....	Page 13

Dryers require regular maintenance. Follow the suggestions below to maintain your dryer properly.

## Maintenance—every load

### Cleaning the lint screen

The lint screen is located under a lid on top of the dryer. **Clean it before each load.** A screen blocked by lint can increase drying time.

1. Open the lid and pull the lint screen straight out.
2. Roll lint off the screen with your fingers. Do not rinse or wash the screen to remove lint. Wet lint is hard to remove.
3. Push the lint screen firmly back into place and close the lid.

**CAUTION**

**Product and Fabric Damage Hazard**

Do not run the dryer with the lint screen loose, damaged, blocked or missing. Doing so can cause overheating and damage to both the dryer and fabrics.

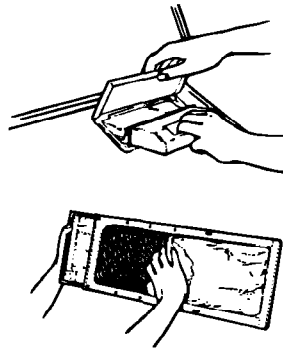

### Lint signal

(on some models)

Restricted airflow reduces drying efficiency. The signal (a whistle tone) lets you know if the airflow is restricted.

- Turn off the dryer and clean the lint screen.

**NOTE:** Clean your lint screen before each load. Do not wait for the lint signal. The lint signal indicates excessive lint present on your lint screen. If you wait for the lint signal before you clean the lint screen, drying efficiency will be reduced.

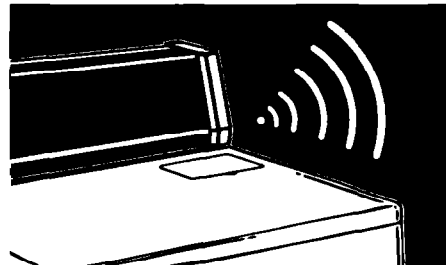

## Maintenance—as needed

Use the following suggestions about cleaning and lint removal to help you keep your dryer safe, looking like new, and at peak operating efficiency.

### Cleaning a clogged lint screen

Laundry detergents and fabric softeners can cause a residue build-up on the lint screen. A clogged lint screen can extend drying times. Clean the lint screen every six months or more frequently if it becomes clogged due to a residue build-up. Use the following method:

1. Wet both sides of lint screen with hot water.
2. Wet a nylon brush with hot water and liquid detergent.
3. Scrub lint screen with the brush until all residue build-up is removed.
4. Rinse with hot water.
5. **Thoroughly** dry lint screen with a clean towel and replace in dryer.

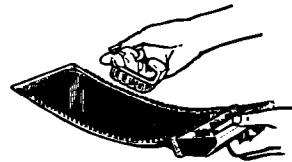

### Cleaning the dryer interior

Garments which contain unstable dyes, such as denim blue jeans or brightly colored cotton items, may discolor the dryer interior.

If you want to remove stains from dryer drum use one of the following methods:

#### Powdered laundry detergent

1. Make a paste with detergent and very warm water.
2. Apply paste to a soft cloth and scrub area until all excess dye is removed.
3. Wipe thoroughly with a damp cloth.
4. Tumble a load of rags to dry.

#### Liquid non-flammable household cleaner

1. Apply to stained area.
2. Rub with a cloth until all excess dye is removed.
3. Wipe thoroughly with a damp cloth.
4. Tumble a load of rags to dry.

### Cleaning the dryer exterior

Wipe with a soft, damp cloth.

## ⚠ WARNING

### Electrical Shock, Personal Injury and Fire Hazard

- Turn off the electrical power before cleaning the interior.
- Make sure the dryer is cool.
- Use non-flammable cleaner.

Failure to do so could result in electrical shock or injury, fire or explosion.

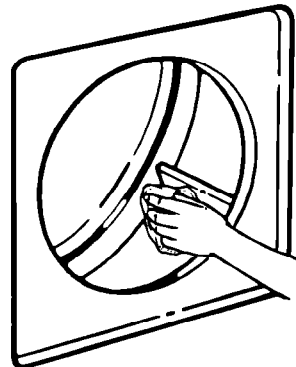

## CARING FOR YOUR DRYER

### Removing accumulated lint

Lint can gather inside the dryer and be a fuel for fire. It is recommended the lint be removed every 2 to 3 years, or more often, depending on dryer usage. Cleaning should be done by a qualified person. If you have any questions, please call our Consumer Assistance Center at 1-800-253-1301.

### For all electric dryers, or gas dryers which have a lower front access panel

**NOTE:** See page 15 if your dryer is gas and has a full front panel.

1. Unplug the power supply cord or turn off the electrical power.
2. Remove back panel (electric) or lower front access panel (gas). See Installation Instructions.
3. Remove lint from shaded area in illustration with a soft brush or vacuum cleaner. Avoid damaging wires, thermostats (electric), funnel (gas) or igniter (gas).
4. Replace panel; reconnect and level dryer again, if necessary.

### **⚠ WARNING**

#### **Electrical Shock and Personal Injury Hazard**

- Unplug the power supply cord or turn off the electrical power before removing dryer panels.
- Make sure the dryer is cool.
- Dryer parts can have sharp edges. Use care when handling.
- When replacing front panel after lint removal, the wire clips holding the door switch wires must be anchored to top of front and side panels. Wires **MUST NOT** touch rotating drum. (See page 15, step 7.)

Failure to do so could result in electrical shock or personal injury.

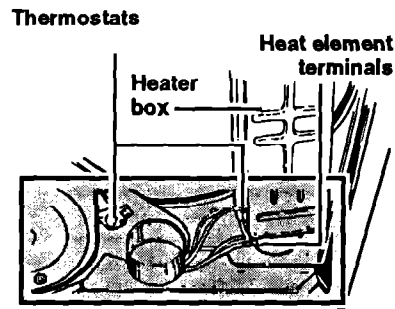

Electric dryer with back panel removed

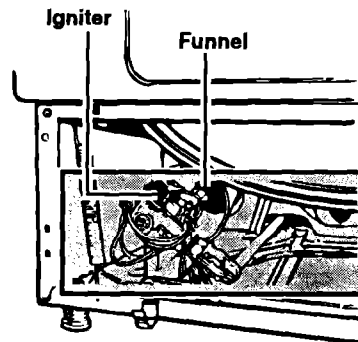

Gas dryer with lower front access panel removed

## CARING FOR YOUR DRYER

### If your dryer is gas and has a full front panel, remove front panel as follows

1. Unplug the power supply cord or turn off the electrical power.
2. Open lint screen lid. Remove two screws from lint screen area.
3. Open top by pulling forward and up at each front corner (see View A). Rest raised top against wall behind dryer (top is hinged at rear).
4. Remove two internal screws from front panel flanges (near top front corners). Lift front panel slightly, lifting off lower clips (see View B). Slowly pull front panel forward, disengaging panel from drum. (Drum will drop slightly.)
5. Move front panel aside and rest edge against side of dryer. Avoid disconnecting wire clips (see View C) or damaging wires.
6. Remove lint from area shown in "gas dryer" illustration on page 14 with soft brush or vacuum cleaner. Avoid damaging wires, funnel or igniter.
7. Reassemble in reverse order. Before closing the top, check the following:
  - Drum seal must be flared out (see View D) and properly positioned against panel at back of drum. Rotate drum counter-clockwise one full turn to check drum seal.
  - Belt should be centered and tight on dryer drum.
  - Wire clips which hold the door switch wires must be anchored in slot in top of front panel (see View C) and along top edge of side panel. Door wires must not touch drum when dryer is operating. **See Warning, page 14.**
8. Replace top panel and lint screen screws. Top and front panels must be securely in place before operating dryer.
9. Reconnect power and level dryer again (if necessary).

**NOTE:** Call Consumer Assistance at 1-800-253-1301 for assistance or more information.

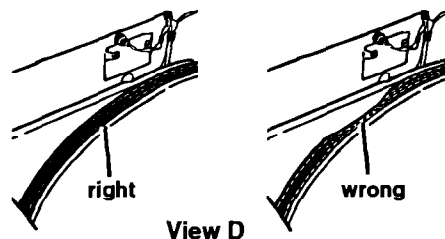
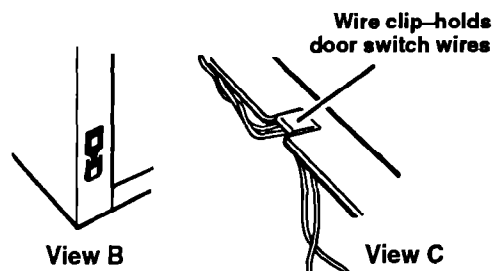
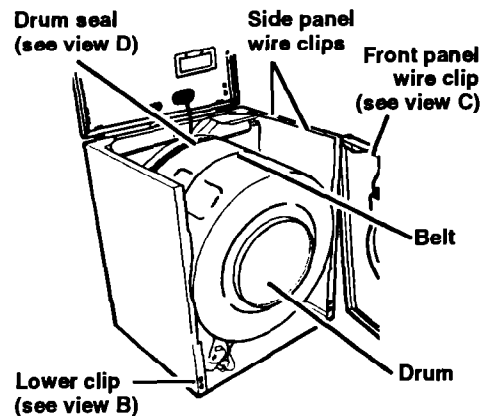
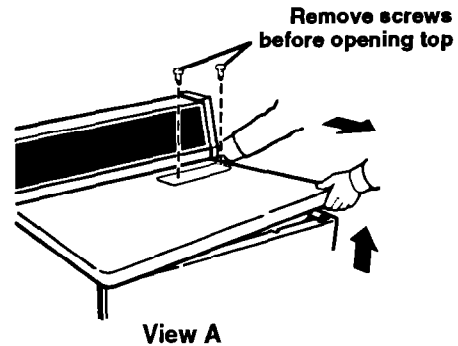

# Laundry Tips

In This Section		Page	Page	
Before you dry .....		16	Saving energy .....	19
Drying special-care items .....		17	Vacation care .....	19
Using dryer fabric softeners .....		19	Solving laundering problems .....	20

This section reviews proper drying techniques, gives you additional drying information, and discusses causes or solutions to common drying problems.

## Before you dry

Before using your dryer, see pages 3 and 4 for Important Safety information.

### **⚠ WARNING**

#### **Fire or Explosion Hazard**

To help avoid the danger of a fire or explosion:

- Store flammable solvents or liquids away from your dryer;
- Dry cleaning solvents or fluids should never be put directly into your dryer;
- If fabric has been treated with dry cleaning solvents, completely rinse and line dry before laundering.

Failure to follow the above precautions could result in fire or explosion.

## Drying tips

- Check garments to make sure all spots and stains were removed during the wash. If stains were not removed, do not tumble dry. Heat may permanently set stain. Soiled items can also leave stains on the dryer drum. These stains can be picked up by other items in the load.
- Empty all pockets. Turn pockets of heavy items inside out for even drying.
- Turn lint takers and dark items inside out to help prevent lint pickup.
- Remove heat-sensitive trim that can be damaged by drying.
- Tie strings and sashes so they will not tangle.
- Place small items such as baby socks or hankies in a mesh bag for easier removal.

- Close zippers, snaps and hooks to avoid snagging other items. Remove pins, buckles and other hard objects to avoid scratching the dryer drum.
- Articles to be ironed should be removed from the dryer while still damp.

## Sorting

- Items properly sorted for washing are usually properly sorted for drying.
- Separate heavy fabrics (denim, towels) from light fabrics (synthetics, permanent press).
- Separate lint givers (towels, chenille) from lint takers (corduroy, synthetics, permanent press). When possible, turn lint takers inside out.
- Separate dark from light colors; colorfast from non-colorfast.

## Load sizes

- Load the dryer by the amount of space items take up, not by their weight.
- Do not overload the dryer. Overcrowding causes uneven drying and wrinkling, and can cause items to wear out faster (because of pilling).
- Mix large items with smaller items.
- You may need to rearrange large items (sheets, blankets, tablecloths) during a cycle to reduce balling or rolling up.
- Reduce wrinkling of permanent press and synthetics by drying smaller loads and removing items from the dryer as soon as tumbling stops.
- For better tumbling action when drying only a few small items, add one or two lint-free towels. This also prevents small, lightweight items from blocking airflow.



## Drying special-care items

Most garments and household textiles have care labels with laundering instructions. Always follow label directions when they are available. General drying instructions for some special washables are included in this section.

<p><b>Air drying</b></p> <hr/> <p><b>Heat-sensitive fabrics</b></p> <ul style="list-style-type: none"> <li>• Olefin, polypropylene, sheer nylon</li> <li>• Cotton and canvas shoes</li> </ul> <p><b>Pillows, stuffed toys</b></p> <ul style="list-style-type: none"> <li>• Feather, foam, polyester</li> </ul> <p><b>Plastic, rubber items</b></p> <ul style="list-style-type: none"> <li>• Shower curtains, tablecloths, baby panties</li> </ul> <p><b>Scatter rugs</b></p>	<p>Heat sensitive fabrics, plastic, rubber or some stuffed items require drying without heat. Use an Air setting or line dry. The Air setting is useful for fluffing bedding and pillows, and dusting draperies and clothing. See Warning on page 8.</p> <p>Follow care label directions.</p> <p>If shoes can be machine laundered:</p> <ol style="list-style-type: none"> <li>1. Place several bath towels in the dryer to act as a buffer, or place shoes on drying rack if your dryer has one.</li> <li>2. If rubber or foam rubber materials are part of the shoe, use an Air setting. For other materials, see your control panel page (pages 9-11) for cycle, time, and temperature recommendations.</li> <li>3. Remove shoes from dryer while still damp and allow to air dry.</li> </ol> <p>If manufacturer recommends machine washing, dry one pillow at a time and:</p> <ol style="list-style-type: none"> <li>1. Make sure coverings are securely stitched.</li> <li>2. Shake and fluff the items by hand several times during the cycle.</li> <li>3. Make sure pillows are completely dry. Feather pillows take a long time to dry.</li> </ol> <p>Follow care label directions.</p> <p>Follow care label directions.</p>
<p><b>Blankets and woolens</b></p> <hr/> <ul style="list-style-type: none"> <li>• Cotton, rayon, synthetic blankets</li> <li>• Electric blankets, electric sheets, woolen blankets, washable woolen garments</li> </ul>	<p>Machine drying knitted woolens is not recommended. Block to shape when wet and allow to air dry. Line dry blankets in shade on a breezy day over two lines. Pin edges together and straighten them. When partly dry, turn the blanket over, re-pin and re-straighten. When dry, brush nap.</p> <p>Dry as recommended for permanent press fabrics on your control panel page (pages 9-11).</p> <p>If manufacturer recommends machine drying:</p> <ol style="list-style-type: none"> <li>1. Place one or two dry towels in the dryer and preheat 3-5 minutes on a high setting. This will dry blankets faster and help avoid pilling.</li> <li>2. Put blanket in dryer with warm towels. Set control for 20 minutes.</li> <li>3. Check after 10 minutes. Remove when still damp. Overdrying and long tumbling can cause shrinking and pilling.</li> <li>4. Place blanket on flat surface or over two lines to finish drying. Gently stretch to original size and shape.</li> <li>5. When completely dry, brush gently to raise nap. Press binding with cool iron if needed.</li> </ol>

## LAUNDRY TIPS

<p><b>Curtains</b></p> <ul style="list-style-type: none"> <li>• Draperies, slipcovers</li> <li>• Sheers, some synthetic curtains</li> <li>• Bonded or laminated fabrics</li> <li>• Slipcovers</li> </ul>	<p>Remove drapery weights and hooks before laundering.</p> <ol style="list-style-type: none"> <li>1. Use lowest temperature or an Air setting.</li> <li>2. Leave room in dryer for load to fluff.</li> <li>3. Remove from dryer while slightly damp. Do not overdry.</li> </ol> <p>Dry only a few minutes.</p> <p>Do not overdry or tumble in high heat. Overdrying loosens the adhesive and causes fabrics to separate.</p> <p>Replace slipcovers while still slightly damp. They will dry to fit tightly.</p>
<p><b>Diapers, baby clothes</b></p>	<p>Wash and dry small items in a mesh bag or pillowcase for convenient handling.</p> <ol style="list-style-type: none"> <li>1. Dry according to fabric and cycle settings listed on your control panel page (pages 9-11).</li> <li>2. Remove diapers and cotton knit items while still slightly damp. They will feel softer, shrink less and be easier to fold.</li> </ol>
<p><b>Elastic Items</b></p>	<p>Dry at lowest temperature setting. Remove from dryer while still slightly damp.</p>
<p><b>Fiberglass materials</b></p>	<p>Do not machine wash or dry fiberglass materials. Small particles can stick to fabrics washed or dried in following loads and cause skin irritation.</p>
<p><b>Flame-retardant finishes</b></p>	<p>Some items have been treated with a flame-retardant finish to improve their resistance to burning. Such items are clearly labeled. To retain flame-retardant qualities through continuous use and washing, clean and dry according to the manufacturer's instructions.</p>
<p><b>Napped Items</b></p> <ul style="list-style-type: none"> <li>• Corduroy, velveteen</li> </ul>	<p>Dry separately or with similar colors to avoid lint transfer. Follow care label directions.</p> <ol style="list-style-type: none"> <li>1. Dry according to fabric and cycle settings shown on your control panel page (pages 9-11).</li> <li>2. Remove from dryer while there is still a trace of moisture.</li> <li>3. Smooth, reshape and air dry before putting away.</li> </ol>
<p><b>Quilted, down-filled Items</b></p>	<p>Follow care label instructions.</p> <ol style="list-style-type: none"> <li>1. Dry one at a time.</li> <li>2. Remove from dryer and shake or fluff the item during the drying cycle.</li> <li>3. Smooth and reshape before putting away.</li> </ol>
<p><b>Snowsuits, jackets</b></p> <ul style="list-style-type: none"> <li>• Nylon, polyester-base</li> </ul>	<p>Check label for fiber content, then see your control panel page (pages 9-11) for cycle and temperature recommendations.</p> <p>Follow care label directions.</p> <ol style="list-style-type: none"> <li>1. Dry garment for about 10 minutes. Remove and turn inside out. Dry for 10 more minutes.</li> <li>2. Remove from dryer immediately and hang on a non-rusting hanger to finish drying. This will help eliminate wrinkles.</li> </ol>
<p><b>Tinted, dyed or non-colorfast items</b></p>	<p>Dry according to fabric, weight and care label instructions. Wipe the dryer drum carefully to remove any dye or lint that can be transferred to other loads. See "Cleaning the dryer interior" on page 13.</p>

<b>Towels</b>	Select cycle according to fabric type. Some towels, particularly those made of a blend of synthetic fibers and natural fibers (polyester and cotton blends), may shed more lint than other towels causing your dryer's lint screen to get full faster. Be sure to remove lint from the dryer lint screen before and after drying new towels.
<b>Washable knits</b>	Do not overdry knits. Overdrying can cause shrinking and static cling. <ol style="list-style-type: none"> <li>1. Select cycle according to fabric and construction.</li> <li>2. Turn synthetics and blends inside out when drying to avoid pilling.</li> <li>3. Remove cotton and rayon knits while still slightly damp. Stretch into shape and lay flat to finish drying.</li> </ol>

## Using dryer fabric softeners

Dryer fabric softeners are recommended for reducing static cling (static can also be reduced by not overdrying) and for softening fabrics. Always follow package instructions carefully.

- Put fabric softener sheet on top of the load **before starting the dryer**. Do not add a fabric softener sheet **after** the cycle has started. Instant heat can cause the fabric softener to spot fabrics.

- Clear, grease-like spots can result from the fabric softener sheet becoming tangled in an item during tumbling. If fabric softener causes a stain, wet the stain and rub with liquid detergent or bar soap, rewash.
- Some fabric softeners can clog the lint screen and slow drying. Use fabric softeners labeled as dryer safe.

## Saving energy

- Dry only full loads without overdrying.
- Avoid overloading dryer, adding wet items to a partly dried load, or opening the door unnecessarily.
- Plan your laundry to dry one load after another. A warm dryer shortens drying time.
- Shorten drying times by exhausting dryer properly and cleaning exhaust duct as needed.
  - Keep the lint screen clean.
  - Use your dryer in a room where room air temperature is above 45°F (7°C).
  - Sort loads by fabric weight and type.

## Vacation care

1. Unplug power supply cord or turn off electrical power supply.
2. Clean lint screen.

## LAUNDRY TIPS

### Solving laundering problems

Most laundering problems are easily solved. Check the following list for problems you may have and possible causes. If you need additional help, check the "Assistance or Service" section on pages 22 and 23.

PROBLEM	CHECK IF	CAUSES/SOLUTIONS
<b>Greasy spots</b>	<p>Dryer fabric softeners were used</p> <p>Undiluted washer fabric softener was used</p> <p>Enough detergent was used</p> <p>Items were clean before they were dried</p>	<p>Follow manufacturer's product directions carefully.</p> <p>Dilute fabric softener before adding to the final rinse.</p> <p>Use enough detergent to hold soil in the wash water until it drains away. Undrained soil can stick to outer tub of the washer and cause greasy spots with next load.</p> <p>Soiled items can stain other items in the load. They can also leave stains on the dryer drum that can be picked up by items in later loads. Dryer heat may permanently set these stains.</p>
<b>Lint</b>	<p>Lint screen is clogged</p> <p>Load is properly sorted</p> <p>Static electricity is attracting lint</p> <p>Load is too big or heavy</p> <p>Paper or tissue was in pocket</p> <p>Enough detergent was used</p> <p>Pilling is being mistaken for lint</p>	<p>Clean lint screen. (See page 12.)</p> <p>Sort lint-givers (bath towels, etc.) from lint-takers (synthetics, permanent press).</p> <p>Use fabric softener in the washer's final rinse. Use correct dryer settings for fabric. Overdrying synthetics can cause lint-attracting static electricity.</p> <p>Dry smaller loads. When items can't tumble freely, air is unable to carry lint to lint screen.</p> <p>Empty pockets carefully. A small scrap of paper can cause a lot of lint.</p> <p>Use enough detergent to hold the lint in the water until it drains away. Base detergent amount on water hardness and soil in wash load.</p> <p>Pilling (surface fuzz) is caused by normal wear and laundering. Pills do not break away easily from the fabric and can often collect lint. Synthetic fabrics are more likely to pill than others, especially at neckbands, elbows and knees.</p>

## LAUNDRY TIPS

PROBLEM	CHECK IF	CAUSES/SOLUTIONS
<b>Shrinking</b>	<p>Items are overdried</p> <p>Fabric type and quality is suitable for drying</p>	<p>Remove items while there is still a trace of moisture. Some items should be removed while damp, then shaped and air dried.</p> <p>Some knits are stretched during manufacturing. Washing and drying returns them to the original size. This is normal. Check quality of garment before buying. Follow fabric care label directions carefully.</p>
<b>Slow drying</b>	<p>There is a large amount of moisture in the load to be dried</p> <p>Cold rinse water is used</p> <p>Room air temperature is below 45°F (7°C)</p> <p>Dryer is exhausted according to Installation Instructions</p> <p>Lint screen is clogged</p> <p>Exhaust duct or outside exhaust hood is clogged</p> <p>Proper electrical supply is used</p>	<p>Some items hold more moisture than others (cottons more than polyester). They take longer to dry. Full loads take longer to dry than small loads of the same fabric.</p> <p>A load rinsed in cold water will take slightly longer to dry than a warm one. Cold rinses, however, help save energy and reduce wrinkling more than warm rinses do.</p> <p>Install dryer in a room where the air temperature is warmer than 45°F (7°C). Cold air increases drying time and may cause wrinkles not to be removed.</p> <p>Install and exhaust your dryer according to the Installation Instructions provided.</p> <p>Clean lint screen before or after each use.</p> <p>Clean if needed.</p> <p>Properly connect the dryer to a grounded electrical circuit that meets the electrical requirements stated in the Installation Instructions.</p>
<b>Static electricity</b>	<p>Load is overdried</p> <p>Fabric softener is used</p> <p>Synthetics, synthetic blends, permanent press and knits are in load</p>	<p>Remove items while there is still a trace of moisture.</p> <p>Use a fabric softener and follow package directions carefully.</p> <p>Synthetics, synthetic blends, permanent press and knits build up static electricity. Use a fabric softener and be careful not to overdry the load.</p>

# If You Need Assistance Or Service

This section is designed to help you save the cost of a service call. Part 1 of this section outlines possible problems, their causes, and actions you can take to solve each problem. Parts 2 and 3 tell you what to do if you still need assistance or service. When calling our Consumer Assistance Center for help or calling for service, please provide a detailed description of the problem, your appliance's complete model and serial numbers and the purchase date. (See page 2.) This information will help us respond properly to your request.

## 1. Before calling for assistance ...

Performance problems often result from little things you can find and fix without tools of any kind. Please check the chart below for problems you can fix. It could save you the cost of a service call.

<b>PROBLEM</b>	<b>CHECK IF</b>	<b>SOLUTION</b>
<b>Dryer will not run.</b>	<p>Power cord is plugged into a live circuit with proper voltage.</p> <p>Dryer door is closed.</p> <p>Start button is pushed firmly.</p> <p>Controls are set in a running or ON position.</p> <p>Home's main fuse has blown or circuit breaker has tripped. Also check if a time-delay fuse or circuit breaker has been used.</p>	<p>Turn cycle control knob to OFF. Firmly plug cord into electrical outlet. Check circuit voltage at fuse/circuit breaker box. Reset controls and push start button.</p> <p>Close door firmly.</p> <p>Push start button.</p> <p>Set controls and push start button.</p> <p>Turn cycle control knob to OFF. Replace fuse with a time-delay fuse of the correct capacity. Reset circuit breaker. Reset controls and push start button.</p>
<b>Dryer will not heat.</b>	<p>Cycle control knob or temperature selector is set on an Air setting.</p> <p>Heat cycle is in its last minutes (there is no heat during that time).</p> <p>Home's main fuse has blown or circuit breaker has tripped. Also check if a time-delayed fuse or circuit breaker has been used.</p> <p>Gas shutoff valves are open both on dryer and on supply line if yours is a gas dryer.</p>	<p>Reset cycle control knob or temperature selector to heat setting.</p> <p>Wait for cycle to finish.</p> <p>Turn cycle control knob to OFF. Replace fuse with a time-delayed fuse of the correct capacity. Reset circuit breaker. Reset controls and push start button.</p> <p>The circuit supplying an electric dryer uses 2 breakers or 2 fuses. If one breaker has tripped or one fuse has blown, the dryer may run, but not heat.</p> <p>Turn cycle control knob to OFF. Open gas valves. Wait 5 minutes. Reset controls and push start button.</p>

**IF YOU NEED ASSISTANCE OR SERVICE**

PROBLEM	CHECK IF	SOLUTION
<b>Drying time too long.</b>	Lint screen is clean.  Exhaust duct or outside exhaust hood is clogged.	Clean lint screen. See instructions on page 12.  See "Slow drying" section of table, page 21, for additional information.  Clean if needed.

**2. If you need assistance ...**

Call Whirlpool Consumer Assistance Center telephone number. Dial free from anywhere in the U.S.:  
**1-800-253-1301**

and talk with one of our trained consultants. The consultant can instruct you in how to obtain satisfactory operation from your appliance or, if service is necessary, recommend a qualified service company in your area.

If you prefer, write to:

Mr. William Clark  
Consumer Assistance Representative  
Whirlpool Corporation  
2000 M-63  
Benton Harbor, MI 49022

Please include a daytime phone number in your correspondence.

**3. If you need service ...**



Whirlpool has a nationwide network of authorized Whirlpool<sup>SM</sup> service companies. Whirlpool service technicians are

trained to fulfill the product warranty and provide after-warranty service, anywhere in the United States. To locate the authorized Whirlpool service company in your area, call our Consumer Assistance Center telephone number (see Step 2) or look in your telephone directory Yellow Pages under:

• **APPLIANCE-HOUSEHOLD-MAJOR, SERVICE & REPAIR**  
- See: Whirlpool Appliances or Authorized Whirlpool Service (Example: XYZ Service Co.)

• **WASHING MACHINES & DRYERS, SERVICE & REPAIR**  
- See: Whirlpool Appliances or Authorized Whirlpool Service (Example: XYZ Service Co.)

**4. If you need FSP® replacement parts ...**

FSP is a registered trademark of Whirlpool Corporation for quality parts. Look for this symbol of quality whenever you need a replacement part for your Estate appliance. FSP replacement parts will fit right and work right, because they are made to the same exacting specifications used to build every new Estate appliance.

To locate FSP replacement parts in your area, refer to Step 3 above or call the Whirlpool Consumer Assistance Center number in Step 2.

**5. If you are not satisfied with how the problem was solved ...**

- Contact the Major Appliance Consumer Action Panel (MACAP). MACAP is a group of independent consumer experts that voices consumer views at the highest levels of the major appliance industry.
- Contact MACAP only when the dealer, authorized servicer and Whirlpool have failed to resolve your problem.

Major Appliance Consumer Action Panel  
20 North Wacker Drive  
Chicago, IL 60606

- MACAP will in turn inform us of your action.

# ESTATE<sup>®</sup> Dryer Warranty

<b>LENGTH OF WARRANTY</b>	<b>WHIRLPOOL WILL PAY FOR</b>
<b>FULL ONE-YEAR WARRANTY</b> From Date of Purchase	FSP <sup>®</sup> replacement parts and repair labor to correct defects in materials or workmanship. Service must be provided by an authorized Whirlpool <sup>SM</sup> service company.
<b>WHIRLPOOL WILL NOT PAY FOR</b>	
<p><b>A. Service calls to:</b></p> <ol style="list-style-type: none"> <li>1. Correct the installation of your dryer.</li> <li>2. Instruct you how to use your dryer.</li> <li>3. Replace house fuses or correct house wiring or plumbing.</li> <li>4. Replace owner accessible light bulbs.</li> </ol> <p><b>B. Repairs when your dryer is used in other than normal, single-family household use.</b></p> <p><b>C. Pickup and delivery. Your dryer is designed to be repaired in the home.</b></p> <p><b>D. Damage to your dryer caused by accident, misuse, fire, flood, acts of God or use of products not approved by Whirlpool.</b></p> <p><b>E. Repairs to parts or systems caused by unauthorized modifications made to the appliance.</b></p>	
<small>8-92</small>	

WHIRLPOOL CORPORATION SHALL NOT BE LIABLE FOR INCIDENTAL OR CONSEQUENTIAL DAMAGES. Some states do not allow the exclusion or limitation of incidental or consequential damages, so this limitation or exclusion may not apply to you. This warranty gives you specific legal rights, and you may also have other rights which vary from state to state.

Outside the United States, a different warranty may also apply. For details, please contact your authorized Whirlpool distributor or military exchange.

If you need service, first see the "Assistance or Service" section of this book. After checking "Assistance or Service," additional help can be found by calling our Consumer Assistance Center telephone number, **1-800-253-1301**, from anywhere in the U.S.