

## CONTENTS

### SAFETY

..... 1-3

### USE AND CARE

Your Counter Unit and Its Features ..... 4

### TO START THINGS COOKING

Cooktop Cooking ..... 4

Control Knobs ..... 4, 6

Spark Ignition ..... 4

Cleaning Tips ..... 6

### BEFORE CALLING FOR SERVICE

What to Do Before Calling for Service ..... 6

### WARRANTY

MODELS 33129

911, 33125

# SEARS

## Kenmore

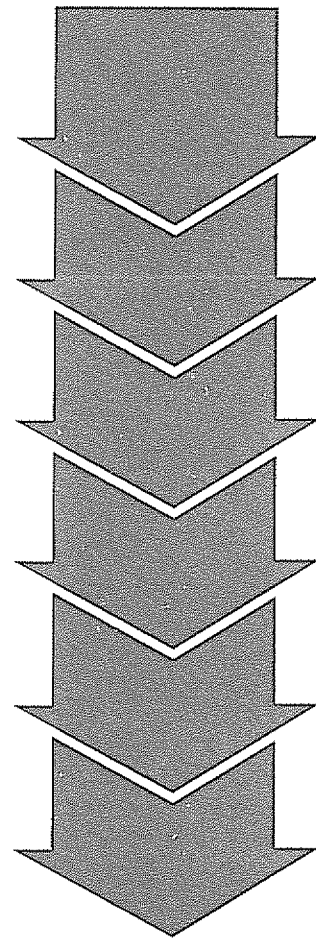

# USE • CARE • SAFETY

## MANUAL

MNM228-2 (SR10074)

IMPORTANT IMPORTANT IMPORTANT IMPORTANT IMPORTANT IMPORTANT IMPORTANT IMPORTANT IMPORTANT

# IMPORTANT INSTRUCTIONS FOR YOUR SAFETY

## SAVE THESE INSTRUCTIONS

Read all instructions before using this appliance. When using electrical appliances, basic safety precautions should be followed, including the following:

**WARNING:** If the information in this manual is not followed exactly, a fire or explosion may result causing property damage, personal injury or death.

— Do not store or use gasoline or other flammable vapors and liquids in the vicinity of this or any other appliance.

### — WHAT TO DO IF YOU SMELL GAS

- Do not try to light any appliance!
- Do not touch any electrical switch; Do not use any phone in your building!
- Immediately call your gas supplier from a neighbor's phone. Follow the gas supplier's instructions!
- If you cannot reach your gas supplier, call the fire department.

— Installation and service must be performed by a qualified installer, service agency or the gas supplier.



### WARNING:

The counter unit, as shipped from the factory, can only be operated with natural gas. Do not try to operate it with L.P. (bottled) gas. High flames and toxic fumes could cause serious injury. If you wish to use your counter unit with L.P. gas, you must make the adjustments described in the Installation Instructions.

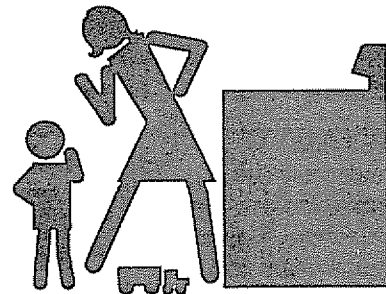

Teach children not to play with control knobs or any other part of the counter unit. Never leave children alone or unattended where a counter unit is in use.

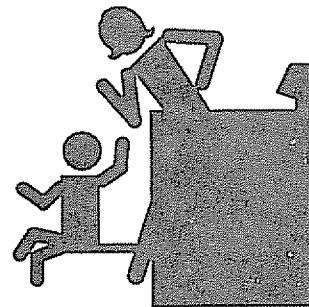

Never let anyone climb, sit or stand on any part of the counter unit.

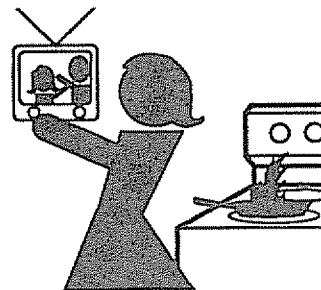

Never leave cooktop elements/burners unwatched at high heat settings. Boilovers cause smoking and greasy spillovers could catch fire.

IMPORTANT IMPORTANT IMPORTANT IMPORTANT IMPORTANT IMPORTANT IMPORTANT IMPORTANT IMPORTANT

To insure safety for yourself and your home, please read your Owner's Manual carefully. Keep it handy for quick easy reference. Pay close attention to the safety sections of your manual. You can recognize the safety sections by looking for the  symbol or the word "Safety".

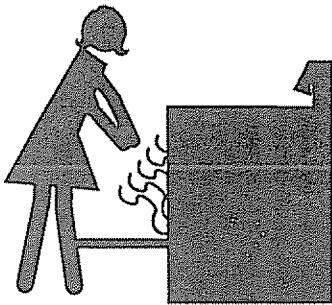

Never use your counter unit for warming or heating a room. You could be burned or seriously injured. Such misuse could also cause damage to the counter unit.

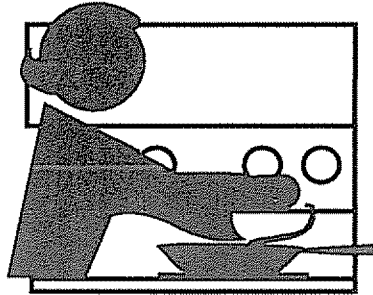

Never wear loose clothing when using your counter unit. Such clothing could catch fire.

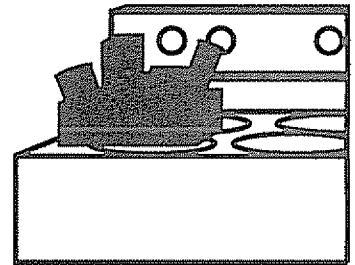

Always keep the counter unit area clear and free from things that will burn.

**CAUTION:**

Never store things in an oven or near cooktop elements/burners. These things may catch fire and plastic items could melt.

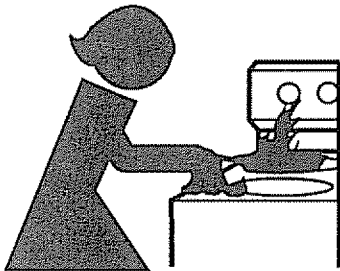

Never use a towel or other bulky cloth as a potholder. Such cloths could catch fire.



Never let pot handles stick out over the front of the counter unit. Turn handles in so that they cannot be bumped into. Keep the handles away from other hot surface elements/burners.



**CAUTION:**

Do Not store items of interest to children above a counter unit. Children climbing on a counter unit to reach such items could be seriously injured.

# IMPORTANT SAFETY INSTRUCTIONS

**Keep this book for later use.**

**Be sure your counter unit is installed and grounded properly by a qualified technician.**

**Always keep the counter unit area clear and free from things that will burn, gasoline and other flammable vapors and liquids.**

**Only some kinds of glass or ceramic pans can be used for cooktop cooking. Be sure that the pan you use will not break when heated on the cooktop burners.**

**Always use dry potholders when removing pans from the cooktop. Moist or damp potholders can cause steam burns.**

**Always follow cleaning instructions in this book.**

**Never try to repair or replace any part of the counter unit unless instructions are given in this book. All other work should be done by a qualified technician.**

**Never heat unopened food containers. Pressure buildup may make container burst and cause injury.**

**Never leave jars or cans of fat or drippings on or near the counter unit. Never let grease build up on your counter unit. You can keep grease fires from starting if you clean up grease and spills after each oven use.**

**Never use aluminum foil to line drip bowls. Improper use of foil could start a fire and cause incomplete combustion.**

**Never block the flow of combustion and ventilation air through cooktop burners.**

**Never try to move a pan of hot fat, especially a deep fat fryer. Wait until the fat has cooled.**

**Never try to remove burner bowls from glass top ranges. Never operate the burners unless the burner tops are in place.**

**Always keep the counter unit clean by following instructions in this book. Food and grease are easy to ignite. Clean the counter unit and vent hood regularly.**

**Always keep combustible wall coverings, curtains or drapes, wooden utensils, plastic utensils or canned food a safe distance away from your counter unit.**

**Never clean cooktop surface when it is hot. Some cleaners produce noxious fumes and wet cloths could cause steam burns if used on a hot surface.**

**Always use care when touching the cooktop. The glass surface of the cooktop will retain heat after controls have been turned off.**

**Always keep dish towels, dish cloths, potholders and other linens a safe distance away from your counter unit. Never store such items on your counter unit.**

**Do not use a wok on the cooking surface if the wok has a round metal ring which is placed over the burner grate to support the wok. This ring acts as a heat trap which may damage the burner grate and burner head. Also, it may cause the burner to work improperly. This may cause a carbon monoxide level above that allowed by current standards, resulting in a health hazard. Exposure to carbon monoxide may cause birth defects or other reproductive harm according to the California safe Drinking Water and Toxic Enforcement Act.**

---

**Be sure everyone in your home knows what to do in case of fire!!**

**Read and understand this information NOW! Should you ever need it, you will not have time for reading.**

**Never use water on a grease fire — it will only spread the flames.**

## COOKTOP GREASE FIRE

**Never pick up a flaming pan...Instead:**

- 1. Turn off the burner.**
- 2. Smother the fire with a tightly fitting pan lid, baking soda or with a dry chemical or foam type extinguisher.**

---

## IMPORTANT SAFETY NOTICE

The California Safe Drinking Water and Toxic Enforcement Act requires the Governor of California to publish a list of substances known to the state to cause cancer, birth defects, or other reproductive harm and requires businesses to warn customers of potential exposure to such substances. Gas appliances can cause minor exposure to four of these substances, namely benzene,

carbon monoxide, formaldehyde and soot, caused primarily by the incomplete combustion of natural gas or L.P. fuels. Properly adjusted ranges, indicated by a bluish rather than a yellow flame, will minimize incomplete combustion. Exposure to these substances can be minimized further by venting with an open window or using a ventilation fan or hood.

# YOUR COUNTER UNIT

## IMPORTANT:

The model and serial number of your counter unit can be found on a tag on the underside of the unit.

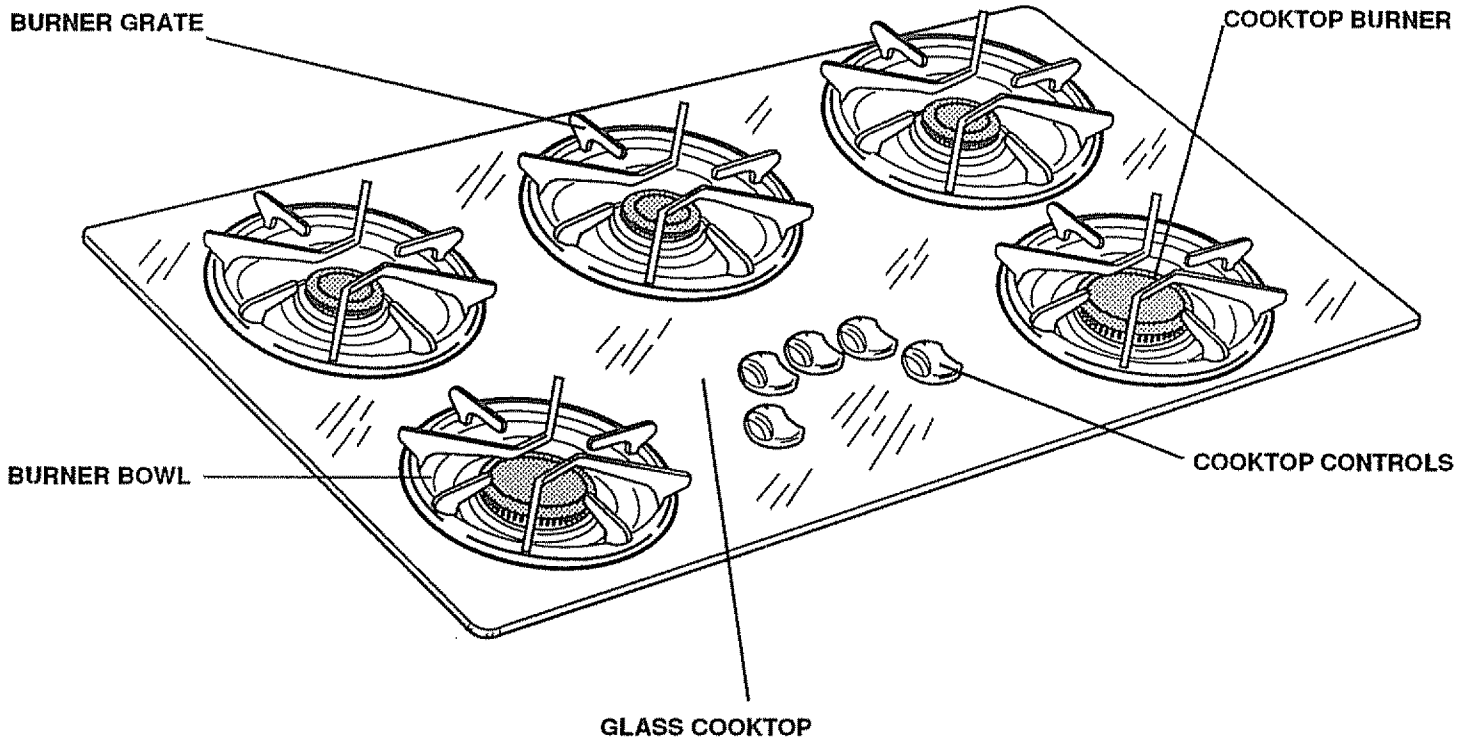

## TO START THINGS COOKING

**COOKTOP SPARK IGNITION** — When you turn the cooktop knob to LITE, the spark igniters make a series of electric sparks (ticking sounds) which light the burner. After the burner ignites turn knob to desired setting.

**TO OPERATE CONTROLS**—The sign near each cooktop control knob shows which burner is turned on by that knob. Push to turn knobs. Turn knob to LITE. Set desired flame setting. All five Igniters spark when any control knob is pushed in.

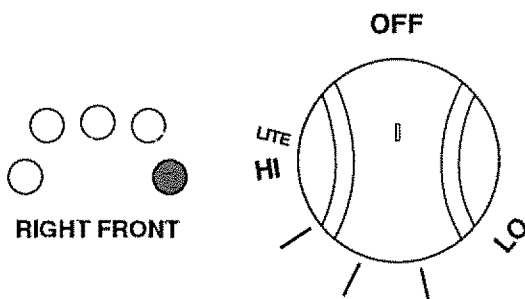

**IMPORTANT:** Do not leave the knob on LITE after the burner lights or the life of the spark igniter may be shortened.

Avoid leaving any burner on without a utensil. Doing so can overheat the grate and cause the enamel finish to become damaged.



As a safety precaution you should set controls so flame heats pan bottom only and does not lick pan sides. Flames licking pan sides are unsafe and waste heat.

If a cooktop burner fails to light within five seconds, turn the knob to OFF and wait five minutes before trying again. If the burner still will not light, check the service section in this manual.

Watch food when heating quickly on HI. As soon as the food reaches cooking temperature, turn down the heat to the lowest setting that will keep it cooking.

The lowest setting of the burner has a very small flame to provide simmering capability. To simmer foods, set the cooktop control knob to the lowest setting that will maintain the desired simmer. If you are using one burner for simmering and turn on additional burners, the gas flow of the simmering burner may have to be adjusted. If your simmering burner goes out when the other burners are on, turn knob back to LITE. After the burner lights, set cooktop control knob to the lowest setting that will retain a flame on the burner.



**During burner use, the area of the glass cooktop around the burners could get hot.**

During a power failure the burners will not light automatically. In an emergency, a cooktop burner may be lit with a match by following the steps below.



**Lighting gas burners with a match is dangerous. You should match light the cooktop burners only in an emergency.**

1. Light a match and hold the flame near the burner you want to light. Wooden matches work best.
2. Push in and turn the control knob slowly. Be sure you are turning the correct knob for the burner you are lighting.

**NOTE:** If the burner does not light within four seconds, turn the knob off and wait five minutes before trying again.

**High flame** may be used to boil large quantities quickly. It is also used to start food cooking quickly in large pans.

**Medium flame** may be used for even browning with little spattering. It is also used to maintain a boil with large quantities of food.

**Low flame** may be used for melting or warming food. It is also best for cooking small quantities of food.

## WOK COOKING

We recommend that you use only a flat-bottomed wok. Flat-bottomed woks are available at your local retail store.

Do not use woks which have support rings. Use of these types of woks, with or without the ring in place, can be dangerous. Placing the ring over the burner grate may damage the burner grate and burner head. Also, placing the ring over the burner grate may cause the burner to work improperly resulting in carbon monoxide levels above allowable current standards. This could be dangerous to your health. See the Safety Section of this manual. Do not try to use such woks without the ring. You could be seriously burned if the wok tipped over.

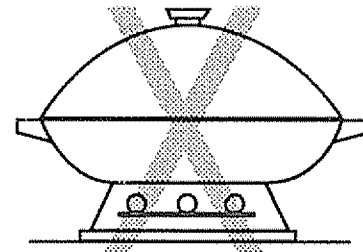
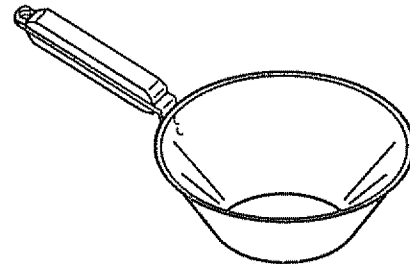

## STOVE TOP GRILLS

Do not use stove top grills on your sealed gas unit. If you use the stove top grill on your sealed gas range it will cause incomplete combustion and can result in exposure to carbon monoxide levels above allowable current standards. This can be hazardous to your health.

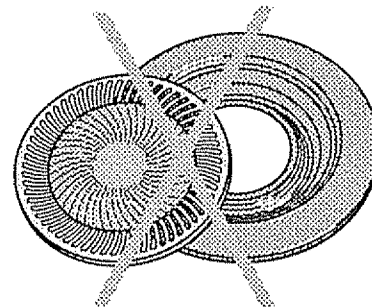

## CLEANING

Be sure that the controls are turned off and that the unit is cool.

**Control Knobs:** Knobs can be removed for easier cleaning. Pull straight off the stem. Wash with detergent, warm water and a soft cloth. Do not scour. When re-installing, be sure to push knob down on the stem.

**Burner Grates and Burner Top:** Clean after each spillover. Disassemble as shown below. Wash with all-purpose, non-abrasive cleaner and warm water. Soak stubborn soil. Rinse and dry completely. Reassemble as explained in the installation section.

**Glass Surface:** Wipe surface clean after each use. If additional cleaning is needed to eliminate spotting, wash with equal parts white vinegar and warm water. Rinse well and dry.

### In cases of burned on spillover:

- Remove excess soil with scraper (single edged razor).
- Scrub cooktop with all-purpose non-abrasive cleaner. We recommend Sears Cooktop Cleaning Creme® (Stock No. 40079, available at Sears, Roebuck & Co.).
- **NEVER USE ABRASIVE SCOURING PADS OR POWDERS ON COOKTOP.** Plastic mesh pads such as Dobie® may be used.



The electrode of the spark igniter is exposed. When cleaning the burner bowl, be careful not to snag the electrode of the spark igniter with your cleaning cloth. Damage to the igniter could occur. Be careful not to turn on any cooktop controls while cleaning burner bowls. A slight electrical shock might result which could cause you to knock over hot cookware.

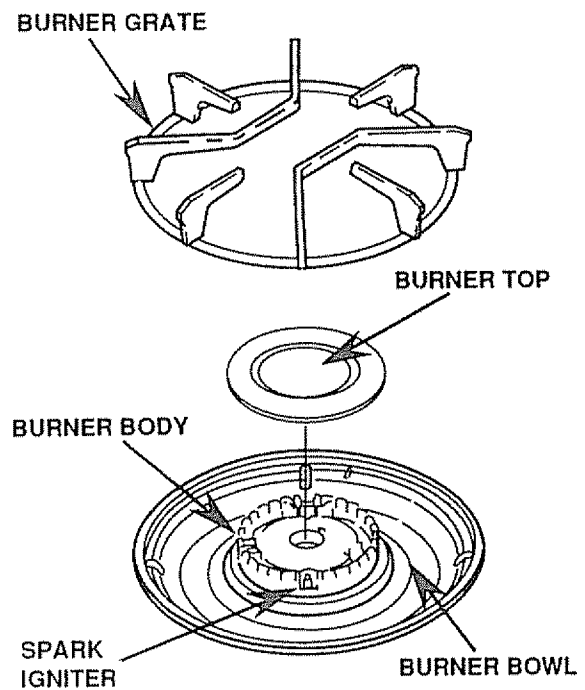

## BEFORE CALLING FOR SERVICE

To eliminate unnecessary service calls, read all the instructions in this manual carefully. Then, if you have a problem, check the table below. If you still have trouble with your unit call your nearest Sears store or service center for help. When calling, have this manual handy with the model number, serial number and purchase date filled in on the front cover.

PROBLEM	SOLUTION
Cooktop knobs will not turn	Push knobs in to turn.
Cooktop burners will not light	<p>Gas supply not connected or not turned on.</p> <p>Counter unit not properly grounded or polarized. This can affect spark ignition. See installation section.</p> <p>No electricity to unit; check for tripped fuse or circuit breaker.</p> <p>Soil clogging holes in burner body. Clean holes.</p> <p>Cooktop burner top not replaced correctly. See installation section.</p> <p>Knob not re-installed correctly. Push knob down on the stem.</p>

# KENMORE GAS COUNTER UNIT WARRANTY

Dear Customer:

Our constant efforts are directed toward making sure your new Kenmore Counter Unit will arrive at your home in perfect condition and will give you proper performance. As part of these efforts, we feel it is our responsibility to provide you with this warranty for your range.

## FULL ONE YEAR WARRANTY ON THE FUNCTIONING OF ALL PARTS EXCEPT GLASS PARTS

If, within one year from the date of installation, any part, other than a glass part, fails to function properly due to a defect in material or workmanship, Sears will repair or replace it, free of charge.

## FULL 30-DAY WARRANTY ON GLASS PARTS AND FINISH OF PORCELAIN ENAMEL, PAINTED OR BRIGHT METAL FINISHED PARTS

If, within 30 days from the date of installation, any glass part or the finish on any porcelain enamel, painted or bright metal part is defective in material or workmanship, Sears will replace the part, free of charge.

## FULL 90-DAY WARRANTY ON MECHANICAL ADJUSTMENTS

For 90 days from the date of installation, Sears will provide, free of charge, any mechanical adjustments necessary for proper operation of the range, except for normal maintenance.

If the unit is subjected to other than private family use, the above warranty coverage is effective for only 90 days.

## WARRANTY SERVICE IS AVAILABLE BY CONTACTING THE NEAREST SEARS SERVICE CENTER/DEPARTMENT IN THE UNITED STATES

This warranty applies only while this product is in use in the United States. This warranty gives you specific legal rights, and you may also have other rights which vary from state to state.

SEARS, ROEBUCK and CO.  
Dept. 731 CR-W  
Sears Tower  
Chicago, IL 60684

## WE SERVICE WHAT WE SELL

"We Service What We Sell" is our assurance to you that you can depend on Sears for service because Sears service is nationwide.

Your Kenmore Counter Unit has added value when you consider that Sears has a service unit near you staffed by Sears trained technicians. . . professional technicians specifically trained on Sears appliances, having the parts, tools and equipment to ensure that we meet our pledge to you — "We Service What We Sell!"

**TO FURTHER ADD TO THE VALUE OF YOUR RANGE, BUY A SEARS MAINTENANCE AGREEMENT.**

Kenmore Counter Units are designed, manufactured and tested for years of dependable operation. Yet, any modern appliance may require service from time to time. The Sears Warranty plus the Sears Maintenance Agreement provides protection from unexpected repair bills and assures you of enjoying maximum range efficiency.

Here's a comparative warranty and Maintenance Agreement chart showing you the benefits of a Sears Range Maintenance Agreement.

Years of Ownership Coverage		1st Year	2nd Year	3rd Year
1	Replacement of Defective Parts other than Porcelain or Glass	W	MA	MA
2	Mechanical Adjustment	90 DAYS W	MA	MA
3	Porcelain and Glass Parts	30 DAYS W	MA	MA
4	Annual Preventive Maintenance Check at your request	MA	MA	MA

W - Warranty MA - Maintenance Agreement

**CONTACT YOUR SEARS SALESPERSON OR LOCAL SEARS SERVICE CENTER TODAY AND PURCHASE A SEARS MAINTENANCE AGREEMENT.**

# Kenmore® America's Best Selling Appliance Brand

Sold by SEARS, ROEBUCK AND CO., Chicago, IL 60684