

READ THIS MANUAL  
for important safety and operating instructions.

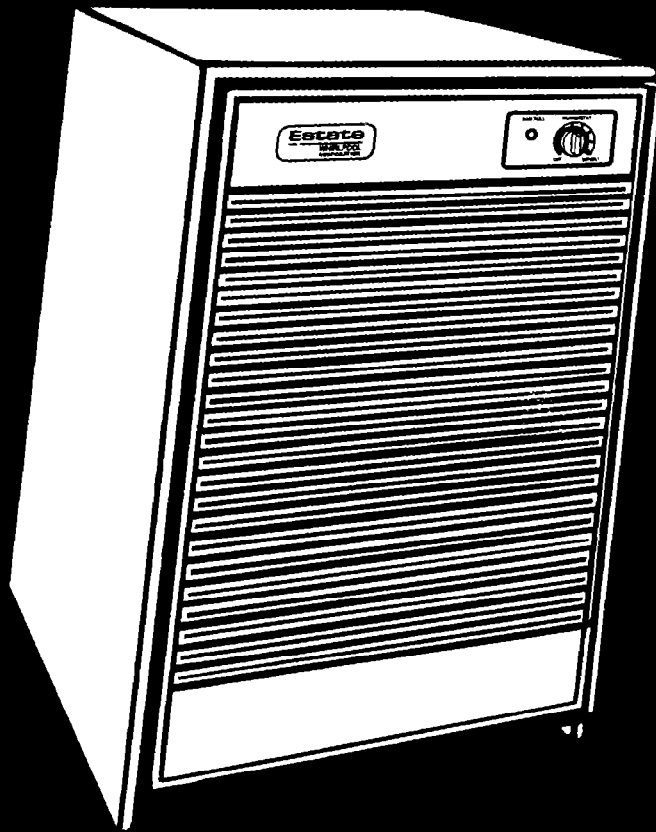

**Estate**  
FROM  
WHIRLPOOL  
CORPORATION

# Dehumidifier Operation Guide

PART NO. 1181714

10-96

# Contents

	Page		Page
<b>Parts and features</b> .....	2	<b>Caring for your dehumidifier</b> .....	8
<b>Before using your dehumidifier</b> .....	3	<b>Troubleshooting</b> .....	10
Install properly .....	3	<b>Requesting assistance or service</b> .....	11
Electrical requirements .....	4	<b>ESTATE® dehumidifier warranty</b> .....	12
<b>Using your dehumidifier</b> .....	5		
To operate .....	5		
<b>Setting the water level adjustment</b> .....	6		
Water disposal .....	7		

# Parts and features

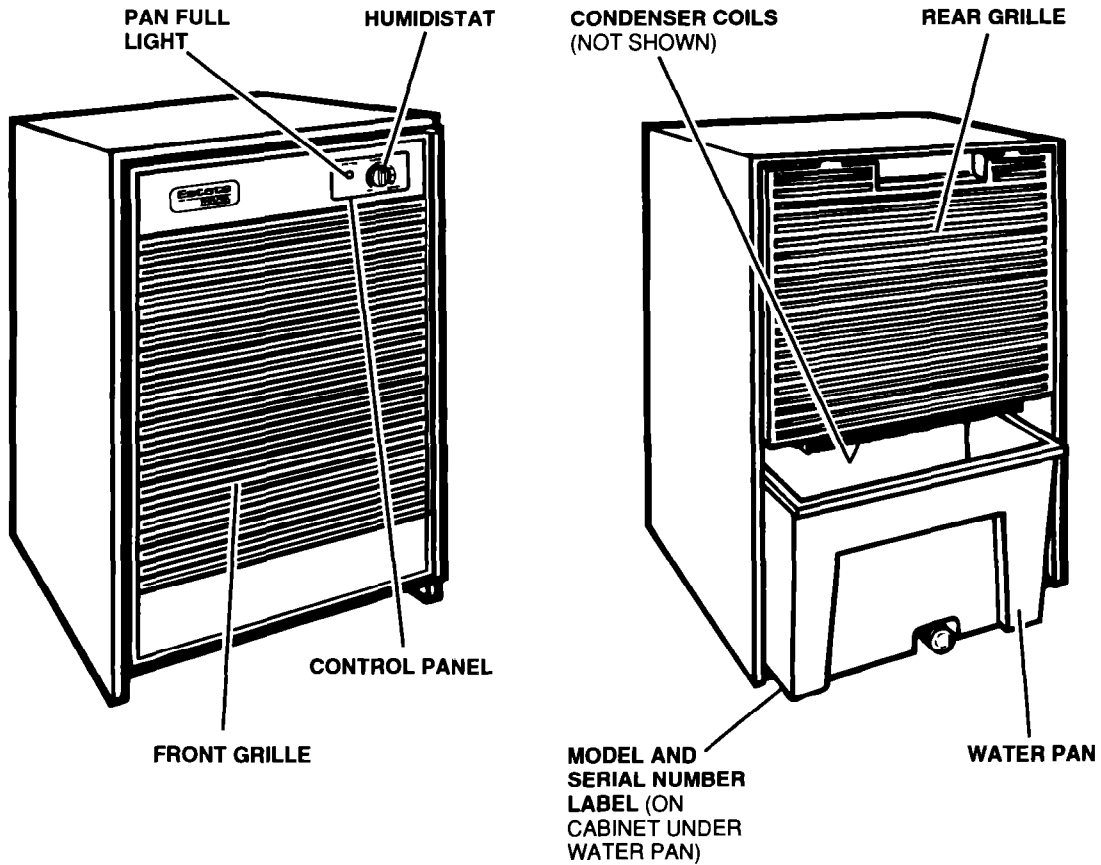

---

## Before using your dehumidifier

---

This booklet tells you how to install your dehumidifier, use it, and clean it. Treat your new dehumidifier with care. Use it only to do what home dehumidifiers are designed to do.

---

### Copy your model and serial number here ...

If you need service or call with a question, have this information ready:

1. Complete model and serial numbers (from the label under the water pan on the base of the unit).
2. Purchase date from sales slip.

**Copy this information in these spaces. Keep this book and your sales slip together in a handy place.**

**Thank you for purchasing an ESTATE® product. Please complete and mail the Owner's Registration Card furnished with this product.**

---

**Model Number**

---

**Serial Number**

---

**Purchase Date**

---

**Service company name and telephone number**

---

---

### It is your responsibility to make sure your dehumidifier:

- Has been properly installed on a floor that is reasonably level.
- Is the correct size for the area you want to dehumidify.
- Is connected to the proper kind of outlet with the correct electrical supply and grounding. (Refer to "Electrical requirements" on page 4.)
- Is used only for jobs expected of home dehumidifiers.
- Is not used by children or anyone not able to operate it properly.
- Is properly maintained.
- Is used in an area where the room temperature will not fall below 65°F (18.3°C).
- Do not remove Tech Sheet which is inside the cabinet. Your service technician needs this information.

---

### Install properly ...

1. There are two rollers under your dehumidifier to help you move it more easily. To move: Remove the water pan, tilt unit forward, and roll to another position.
2. **Allow at least 12 inches (30.5 cm) of space around the unit for good air circulation.**
3. Keep all outside doors, windows, and other openings closed when dehumidifier is operating. Humid outdoor air will add to the dehumidifier's operating load.
4. **Water pan must be properly positioned on the hangers inside the cabinet when dehumidifier is operating in order for the automatic shut-off to operate correctly.**

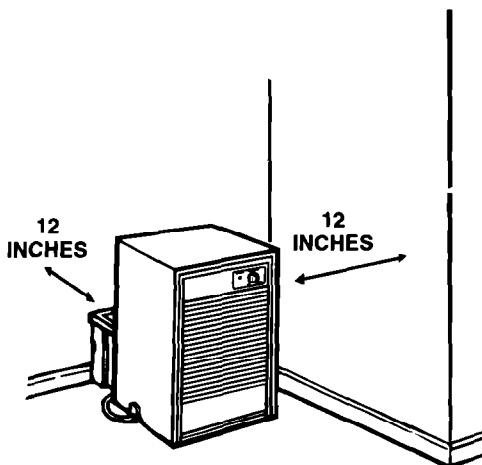

## Electrical requirements

### OBSERVE ALL GOVERNING CODES AND ORDINANCES.

**Electrical ground is required on this appliance.**

A 115 volt, 60 Hz., AC only, 15 or 20 ampere fused electrical supply is recommended. (Time delay fuse or circuit breaker is recommended.) It is recommended that a separate circuit serving only this appliance be provided. **Do not use an extension cord.**

**DO NOT, UNDER ANY CIRCUMSTANCES, REMOVE THE POWER SUPPLY CORD GROUND PRONG.**

### RECOMMENDED GROUNDING METHOD

For your personal safety, this appliance must be grounded. This appliance is equipped with a power supply cord having a 3-prong grounding plug. To minimize possible shock hazard, the cord must be plugged into a mating grounding type wall receptacle, grounded in accordance with the National Electrical Code and local codes and ordinances. If a mating wall receptacle is not available, it is the responsibility of the customer to have a properly grounded, 3-prong wall receptacle installed by a qualified electrician.

## ⚠ WARNING



### Electrical Shock Hazard

**Plug into a grounded 3 prong outlet.**

**Do not remove ground prong.**

**Do not use an adapter.**

**Do not use an extension cord.**

**Failure to follow these instructions can result in death, fire, or electrical shock.**

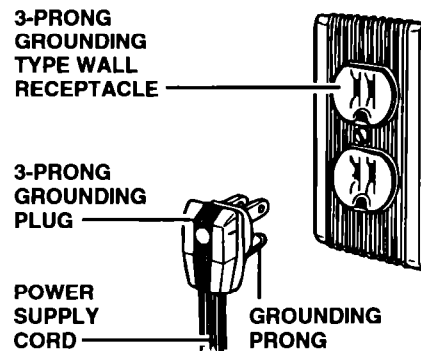

## Using your dehumidifier

You will use your dehumidifier more during months when you're not heating your home. However, your dehumidifier can help prevent excessive moisture and keep you comfortable all year in any area of your home.

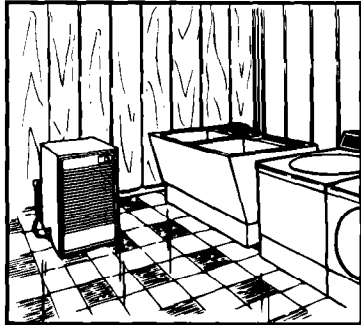

Use in a basement to help prevent moisture damage.

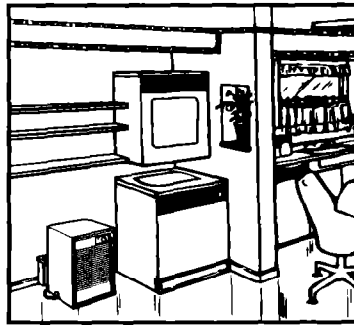

Use in cooking, laundry, bathing, and dishwashing areas which have excess moisture.

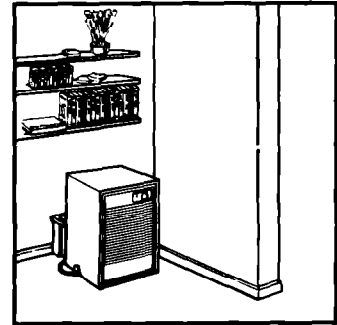

Use to prevent moisture damage anywhere books or valuables are stored.

**NOTE: Do not operate your dehumidifier in temperatures below 65°F (18.3°C). The coil may become iced over at low temperatures and unit will not operate properly.**

Your dehumidifier has a **PAN FULL Light**. The light glows when the pan is full of water to indicate that it needs emptying.

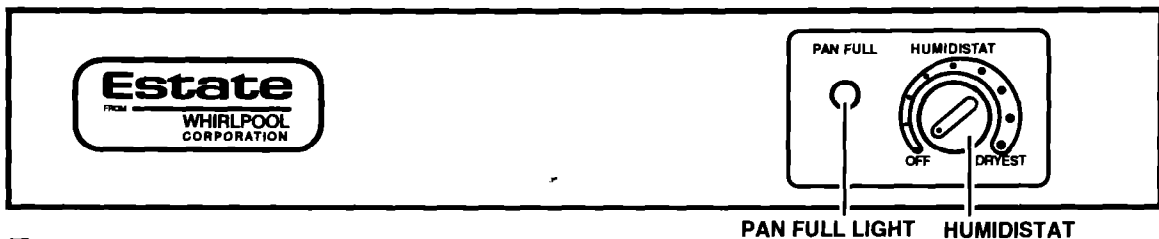

To operate:

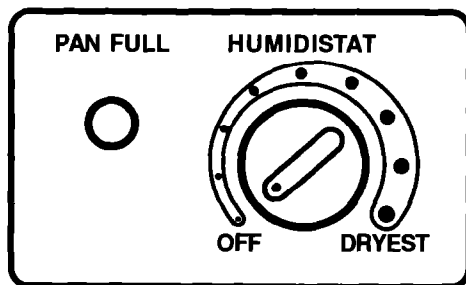

1. Turn Humidistat Control to OFF, then plug in the dehumidifier.

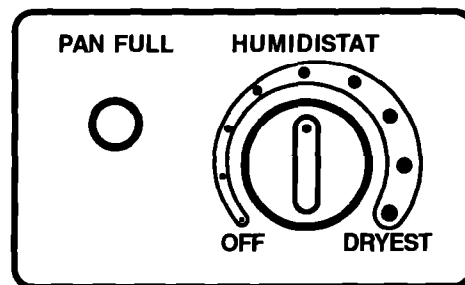

2. Your dehumidifier has an **automatic humidistat**. Turn the Humidistat Control clockwise toward DRYEST for normal operation. Adjust later, if necessary.

When humidity in the room increases, the dehumidifier automatically starts. When the humidity decreases to the selected level, the dehumidifier automatically stops.

*continued on next page*

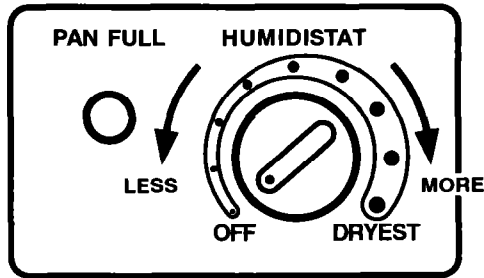

**NOTE:** Do not operate your dehumidifier in temperatures below 65°F (18.3°C). The coil may become iced over at low temperatures and the unit will not operate properly.

3. If you need more dehumidification, turn control clockwise. Unit will run continuously at DRYEST setting. If you need less dehumidification, turn control counterclockwise.

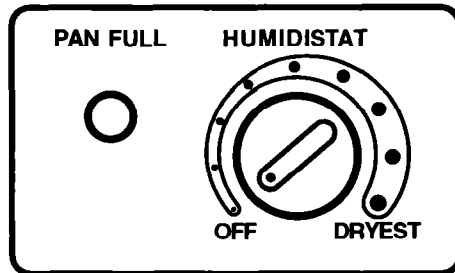

4. Stop the unit manually by turning the control to OFF.

## Setting the water level adjustment

The Water Level Adjustment can be set in two positions to turn off the unit automatically when the pan is full. This prevents the danger of overflow.

**Pan must be in proper position for Water Level Control Switch to work.**

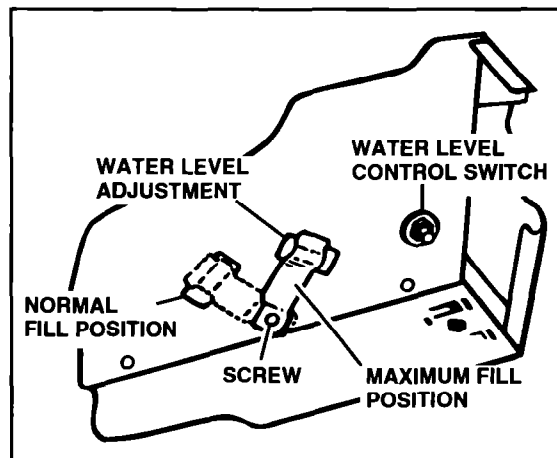

### NORMAL FILL POSITION

Set Water Level Control Lever to the indentation on the left side. The water pan and water will weigh approximately 16 lbs. (7.2 kg) and water pan will be 1/2 full.

### MAXIMUM FILL POSITION

Set Water Level Control Lever to the raised area on the right side. The water pan and water will weigh approximately 24 lbs. (10.8 kg) and water pan will be 3/4 full.

The Water Level Control Switch will automatically turn off the dehumidifier at the fill level you selected when pan is properly placed. Loosen the screw to move the Water Level Adjustment. Retighten screw when adjusted.

## Water disposal

### **⚠ WARNING**

#### **Sickness Hazard**

**Do not drink water collected in water pan.**

**Doing so can result in sickness.**

**There are three methods of disposing water.**

#### **1. Empty pan manually.**

When pan is full, remove it, empty it into a large sink or tub, and replace it properly.

**Be sure pan is replaced properly so the Water Level Control Switch will work to automatically shut off the unit.**

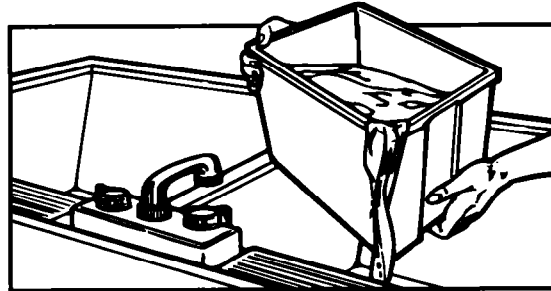

#### **2. Place unit directly over drain.**

Pan has a threaded hose connection which can be left open. Cut out opening with a knife or  $\frac{3}{4}$ -inch (19 mm) wood drill. Once opened, hose connection will continually drain water from the pan. Be sure to keep unit directly over a drain.

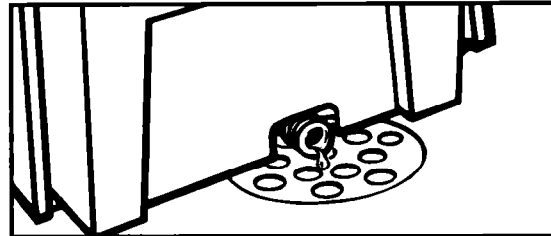

#### **3. Attach garden hose to the threaded hose connection to carry water to drain.**

- Pan has a threaded hose connection which can be left open. Cut out opening with a knife or  $\frac{3}{4}$ -inch (19 mm) wood drill.
- Attach garden hose. Be sure hose does not kink or bend. It should lie flat from unit to drain.
- The recommended maximum hose length is 8' for easy draining of water.

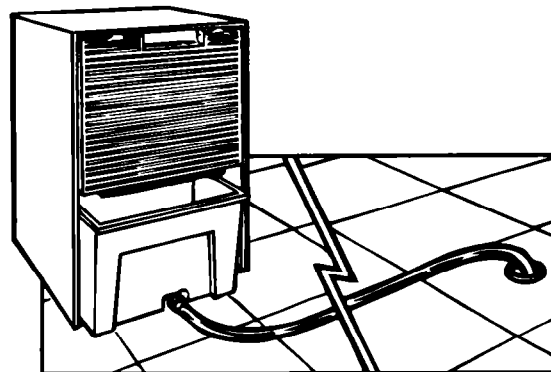

# Caring for your dehumidifier

Your dehumidifier is designed to serve you year-round. It needs practically no attention. However, you should check your dehumidifier and inspect the coils annually.

You may call a service company to perform this annual checkup. (Cost of inspection is the owner's responsibility.)

**OR**

If you are familiar with electrical appliances and their functions, following are instructions which would allow you to do the inspection and maintenance yourself.

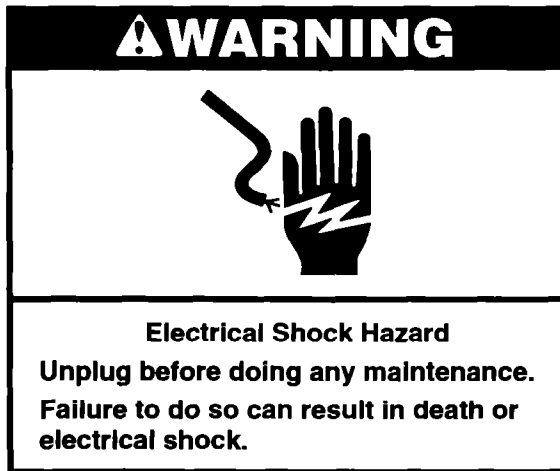

1. Unplug the dehumidifier from power supply.
2. To remove outer cabinet:
  - a. Take off the plastic front-grille. Remove the two screws at bottom front of grille. Drop grille down and pull it out.
  - b. Remove the socket-head screws on each side of the cabinet and the top flange screws (See illustrations). Also, remove the rear grille. Pull out at bottom and drop grille down.
  - c. Lift cabinet from unit.

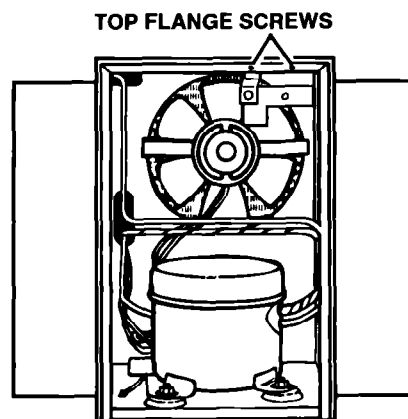
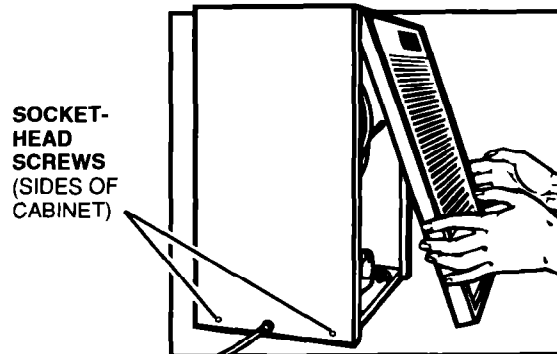
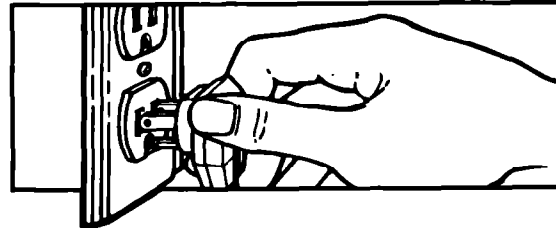



3. Coils should be inspected annually. Brush coils clean, if necessary, with warm water and a mild detergent. Rinse and dry thoroughly. **Be sure the power supply cord is disconnected from the electrical outlet.**
4. The compressor is sealed and needs no oiling.
5. The fan motor is permanently lubricated and does not require further oiling.
6. Wash all plastic parts with a soft cloth, warm water, and a mild detergent. Rinse and dry them with a soft cloth.
7. Replace cabinet and grille(s). Plug dehumidifier into power supply.

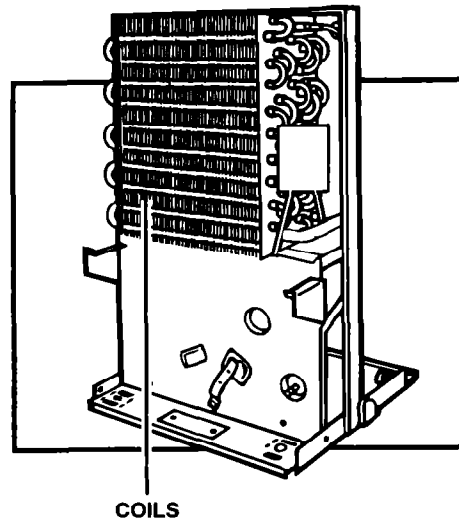

# Troubleshooting

Performance problems often result from little things you can find and fix without tools of any kind. Please check the chart below for problems you can fix. It could save you the cost of a service call.

<b>PROBLEM</b>	<b>POSSIBLE CAUSE</b>
<b>Unit will not run</b>	<ul style="list-style-type: none"><li>• Is unit plugged into a live circuit with the proper voltage?</li><li>• Is the Humidistat Control set to a position other than OFF? Try a drier setting.</li><li>• Has a household fuse blown or circuit breaker tripped? Use the correct time-delay fuses. Do not use an extension cord.</li></ul>
<b>Unit runs but does not dehumidify</b>	<ul style="list-style-type: none"><li>• Is unit in defrost cycle (on 50-pint models only)?</li></ul>
<b>Coils ice over</b>	<ul style="list-style-type: none"><li>• Is room temperature below 65°F (18.3°C)? Coils will become iced over at low temperatures.</li><li>• Are coils clogged with lint? Clean lint from coils (see "Caring for your dehumidifier" on pages 8-9).</li></ul>
<b>Water collects on floor</b>	<ul style="list-style-type: none"><li>• Is unit reasonably level? Level unit front to back and side to side.</li><li>• Is hose kinked or drain clogged?</li><li>• Is water pan overflowing? Remove and empty water pan. Replace pan properly and check to see that unit is level.</li></ul>

**NOTE:** When moving your dehumidifier, keep the unit in an upright position.

# Requesting assistance or service

Before calling for assistance or service, please check "Troubleshooting" on page 10. It may save you the cost of a service call. If you still need help, follow the instructions below.

## 1. If you need assistance\* ...

Call Whirlpool Consumer Assistance



**Center telephone number.  
Dial toll-free from anywhere  
in the U.S.A.:**

**1-800-253-1301**

and talk with one of our trained consultants. The consultant can instruct you in how to obtain satisfactory operation from your appliance or, if service is necessary, recommend a qualified service company in your area.

If you prefer, write to:

Consumer Assistance Center  
c/o Correspondence Dept.  
2000 North M-63  
Benton Harbor, MI 49022-2692

Please include a daytime phone number in your correspondence.

## 2. If you need service\*...

Whirlpool has a nationwide network of



authorized Whirlpool service companies. Whirlpool service technicians are trained to fulfill the product warranty and provide after-warranty service, anywhere in the United States. To locate

the authorized Whirlpool service company in your area, call our Consumer Assistance Center telephone number (see Step 1) or look in your telephone directory Yellow Pages under:

**• APPLIANCE-HOUSEHOLD-  
MAJOR, SERVICE & REPAIR**

- See: Whirlpool Appliances or  
Authorized Whirlpool Service  
(Example: XYZ Service Co.)

**• WASHING MACHINES &  
DRYERS, SERVICE & REPAIR**

- See: Whirlpool Appliances or  
Authorized Whirlpool Service  
(Example: XYZ Service Co.)

## 3. If you need FSP® replacement parts ...

FSP is a registered trademark of Whirlpool Corporation for quality parts. Look for this symbol of quality whenever you need a replacement part for your WHIRLPOOL® appliance. FSP replacement parts will fit right and work right, because they are made to the same exacting specifications used to build every new WHIRLPOOL appliance.

To locate FSP replacement parts in your area, refer to Step 2 or call the Whirlpool Consumer Assistance Center number in Step 1.

## 4. If you are not satisfied with how the problem was solved ...

- Contact the Major Appliance Consumer Action Program (MACAP). MACAP is a group of independent consumer experts that voices consumer views at the highest levels of the major appliance industry.
- Contact MACAP only when the dealer, authorized servicer, and Whirlpool have failed to resolve your problem.  
Major Appliance Consumer Action Program  
20 North Wacker Drive  
Chicago, IL 60606
- MACAP will in turn inform us of your action.

### \*When asking for help or service:

Please provide a detailed description of the problem, your appliance's complete model and serial numbers, and the purchase date. (See page 3.) This information will help us respond properly to your request.

# ESTATE®

## Dehumidifier Warranty

LENGTH OF WARRANTY	WHIRLPOOL WILL PAY FOR						
<b>FULL ONE-YEAR WARRANTY FROM DATE OF PURCHASE</b>	FSP® replacement parts and repair labor to correct defects in materials or workmanship. Service must be provided by an authorized Whirlpool service company.						
<b>FULL FIVE-YEAR WARRANTY FROM DATE OF PURCHASE</b>	FSP replacement parts and repair labor to correct defects in materials or workmanship in the sealed refrigeration system. These parts are: <table style="margin-left: 40px; border: none;"> <tr> <td style="padding-right: 20px;">1. Compressor</td> <td style="padding-right: 20px;">3. Condenser</td> <td>5. Connecting Tubing</td> </tr> <tr> <td>2. Evaporator</td> <td>4. Drier-Strainer</td> <td></td> </tr> </table> Service must be provided by an authorized Whirlpool service company.	1. Compressor	3. Condenser	5. Connecting Tubing	2. Evaporator	4. Drier-Strainer	
1. Compressor	3. Condenser	5. Connecting Tubing					
2. Evaporator	4. Drier-Strainer						
<b>WHIRLPOOL WILL NOT PAY FOR</b>							
<p><b>A. Service calls to:</b></p> <ol style="list-style-type: none"> <li>1. Correct the installation of your dehumidifier.</li> <li>2. Instruct you how to use your dehumidifier.</li> <li>3. Replace house fuses or correct house wiring.</li> </ol> <p><b>B. Pickup and delivery.</b> Your dehumidifier is designed to be repaired in the home.</p> <p><b>C. Damage to your dehumidifier caused by accident, misuse, fire, flood, acts of God, or use of products not approved by Whirlpool.</b></p> <p><b>D. Repairs to parts or systems caused by unauthorized modifications made to the appliance.</b></p>							

9/96

**WHIRLPOOL CORPORATION SHALL NOT BE LIABLE FOR INCIDENTAL OR CONSEQUENTIAL DAMAGES.** Some states do not allow the exclusion or limitation of incidental or consequential damages, so this exclusion or limitation may not apply to you. This warranty gives you specific legal rights, and you may also have other rights which vary from state to state.

**Outside the United States, a different warranty may apply. For details, please contact your authorized Whirlpool dealer.**

If you need service, first see the "Troubleshooting" section of this book. After checking "Troubleshooting," additional help can be found by checking the "Requesting Assistance or Service" section, or by calling our Consumer Assistance Center telephone number, **1-800-253-1301**, from anywhere in the U.S.A.



Manufactured by Whirlpool Corporation

**PART NO. 1181714**

© 1996 Whirlpool Corporation

® Registered Trademark of Whirlpool, U.S.A.

10/96

Printed in U.S.A.