



Use & Care Guide

Built-In Double Wall Oven



 **Electrolux**

2 Finding Information

MAKE A RECORD FOR FUTURE USE

Brand _____

Purchase Date _____

Model Number _____

Serial Number _____

NOTE

See the Features page later in this manual for the location of your product's serial

QUESTIONS?

For toll-free telephone support in the U.S. and Canada:
1-877-4ELECTROLUX (1-877-435-3287)

For on-line support and internet product information:
www.electrolux.com

TABLE OF CONTENTS

Finding Information	2	Care & Cleaning	34-39
Make a Record for Future use	2	Using the Self-Clean Feature	34
Questions?	2	Starting Self-Cleaning Cycle	35-36
Safety	4-6	General Cleaning	37
Important Safety Instructions	4	Care and Cleaning of Stainless Steel	38
Feature Overview	7	To Remove and Replace Oven Door	38
Your Wall Oven	7	Special Door Care Instructions	38
Getting Started	8-9	To Remove the "Hidden Bake Element" Cover	39
Oven Vent Location	8	Oven Light	39
Installing Oven Rack Supports	8	Adjusting Oven Temperature	40
Removing and Replacing Oven Racks	8	Solutions to Common Problems	41-43
Arranging Oven Racks	9	Oven Controls Beeps and Displays "F" Code .	41
Air Circulation in the Oven	9	Installation	41
Setting oven controls	10-16	Entire Oven Does Not Operate	41-42
Control Pads Functions	10	Oven Light Does Not Operate	42
Setting the Clock	11	Self-Clean Cycle Does Not Work	42
Setting Continuous Bake or 12 hours Energy Saving	12	Oven Smokes Excessively During Broiling	42
Setting the Kitchen Timer	13	Soil Not Completely Removed After Self-Cleaning Cycle Is Completed	43
Setting Oven Lockout Feature	14	Poor Baking Results	43
Setting Temperature Display	15	Flames Inside Oven Or Smoke From Vent	43
Setting Silent Control Operation	16	Warranty Information	44
Cooking Instructions	17-33		
Preheating	17		
Baking	18		
Baking Problems	19		
Convection Baking	20-21		
Convection Roasting	22		
Setting Convection Convert	23		
Setting Delayed Bake or Delayed Convection Bake	24		
Setting Timed Bake or Timed Convection Bake	25		
Setting Delayed Timed Bake or Delayed Timed Convection Bake	26-27		
Setting the Keep Warm Feature	28-29		
Broiling	30-31		
Sabbath Feature (for use on the Jewish Sabbath & Holidays)	32-33		

4 Safety

IMPORTANT SAFETY INSTRUCTIONS

Please read all safety instructions before using your new Electrolux wall oven.

WARNING

To reduce the risk of fire, electrical shock, or injury when using your wall oven, follow basic precautions including the following:

- **Remove all tape and packaging wrap before using the appliance. Destroy the carton and plastic bags after unpacking the appliance.** Never allow children to play with packaging material. Do not remove the wiring label and other literature attached to the back of the wall oven. Do not remove model/serial number plate.
- **Proper Installation—Be sure your appliance is properly installed and grounded by a qualified electrician or installer in accordance with the National Electrical Code ANSI/NFPA No. 70 (U.S.A.) or CSA C22.1, PART 1 (Canada)—latest editions and local code requirements.** Install only per installation instructions provided in the literature package for this appliance.

Ask your dealer to recommend a qualified technician and an authorized repair service. Know how to disconnect the electrical power to the appliance at the circuit breaker or fuse box in case of an emergency.

 CAUTION Electronic controllers can be damaged by cold temperatures. When you use your appliance for the first time, or if it has not been used for a long period of time, make sure that it has been exposed to a temperature above 0°C/32°F for at least 3 hours before connecting it to the power supply.

- **User Servicing—Do not repair or replace any part of the appliance unless specifically recommended in the manuals.** All other servicing should be done only by a qualified technician to reduce the risk of personal injury and damage to the appliance.
- **Never modify or alter the construction of the appliance by removing panels, wire covers, or any other part of the product.**
- **Remove the oven door from any unused appliance if it is to be stored or discarded.**

 WARNING Stepping, leaning, sitting or pulling down on the door of this appliance can result in serious injuries and may also cause damage to the appliance. Do not allow children to climb or play around the appliance.

- **Storage in or on Appliance—Flammable materials should not be stored in an oven.** This includes paper, plastic and cloth items, such as cookbooks, plasticware and towels, as well as flammable liquids. Do not store explosives, such as aerosol cans, in or near the appliance.

 WARNING Do not use the oven for storage.

 CAUTION Do not store items of interest to children in the cabinets above an appliance. Children climbing on the oven can be seriously injured.

⚠ WARNING To reduce the risk of tipping of the appliance. The appliance must be secured by properly install the mounting brackets. To check if brackets are installed properly open the oven door and verify that the mounting brackets are engaged see installation instructions.

- **Do not leave children alone—Children should not be left alone or unattended in the area where an appliance is in use.** They should never be allowed to sit or stand on any part of the appliance.
- **DO NOT TOUCH INTERIOR OVEN ELEMENTS OR INTERIOR SURFACES OF THE WALL OVEN UNTIL THEY HAVE COOLED.** The oven heating elements may be hot even though the elements are dark in color. Areas near the elements may become hot enough to cause burns. During and after use, do not touch, or let clothing or other flammable materials touch these areas until they have had sufficient time to cool. Among these areas are the oven vent openings, the surfaces near these openings, oven door and window.
- **Wear Proper Apparel—Loose-fitting or hanging garments should never be worn while using the appliance.** Do not let clothing or other flammable materials contact hot surfaces.

⚠ WARNING Never use your appliance for warming or heating the room.

- **Do Not Use Water or Flour on Grease Fires—Smother the fire with a pan lid, or use baking soda, a dry chemical or foam-type extinguisher.**
- **When heating fat or grease, watch it closely.** Fat or grease may catch fire if allowed to become too hot.
- **Use Only Dry Pot holders—Moist or damp pot holders on hot surfaces may result in burns from steam.** Do not let the pot holders touch the hot heating elements. Do not use a towel or other bulky cloth instead of a pot holder.
- **Do Not Heat Unopened Food Containers—Build-up of pressure may cause the container to burst and result in injury.**

IMPORTANT INSTRUCTIONS FOR USING YOUR OVEN

- **Use Care When Opening an Oven Door—**Stand to the side of the appliance when opening the door of a hot oven. Let hot air or steam escape before you remove or replace food in the oven.
- **Keep Oven Vent Ducts Unobstructed.** The wall oven is vented at the upper control panel or at the center trim depending of the model. Touching the surfaces in this area when the wall oven is operating may cause severe burns. Also, do not place plastic or heat-sensitive items near the oven vent. These items could melt or ignite.
- **Placement of Oven Racks.** Always place oven racks in desired location while oven is cool. Remove all utensils from the rack before removing rack. If rack must be moved while oven is hot, use extreme caution. Use pot holders and grasp the rack with both hands to reposition. Do not let pot holders contact the hot oven element or interior of the oven.
- **Do not use the broiler pan without its insert.** The broiler pan and insert allow dripping fat to drain and be kept away from the high heat of the broiler.

6 Safety

IMPORTANT SAFETY INSTRUCTIONS

- **Do not cover the broiler pan insert or oven bottom with aluminum foil.** Exposed fat and grease could ignite.
- **Do not touch a hot oven light bulb with a damp cloth.** Doing so could cause the bulb to break. Disconnect the appliance or shut off the power to the appliance before removing and replacing the bulb.

IMPORTANT INSTRUCTIONS FOR CLEANING YOUR OVEN

- **Clean the appliance regularly to keep all parts free of grease that could ignite.** Exhaust fan ventilation hoods and grease filters should be kept clean. Do not allow grease to accumulate. Greasy deposits in the fan could ignite. Refer to the hood manufacturer's instructions for cleaning.

SELF CLEANING OVENS

- **Clean in the self-cleaning cycle only the parts of the appliance listed in this Owner's Guide.** Before using the self-cleaning cycle of the appliance, remove the broiler pan, oven racks and any utensils stored in the appliance. Also the side rails of the oven racks must be removed for the self-clean function to operate.
- **Do not clean the oven door gasket.** The door gasket is essential for a good seal. Care should be taken not to rub, damage or move the gasket.
- **Do not use oven cleaners.** No oven cleaner or oven liner protective coating of any kind should be used in or around any part of the appliance

⚠ CAUTION The health of some birds is extremely sensitive to the fumes given off during the self-clean cycle of any wall oven. Move birds to another well ventilated room.

IMPORTANT SAFETY NOTICE

The California Safe Drinking Water and Toxic Enforcement Act requires the Governor of California to publish a list of substances known to the state to cause cancer, birth defects or other reproductive harm, and requires businesses to warn customers of potential exposure to such substances.

NOTE

Save these important safety instructions for future reference.

YOUR WALL OVEN

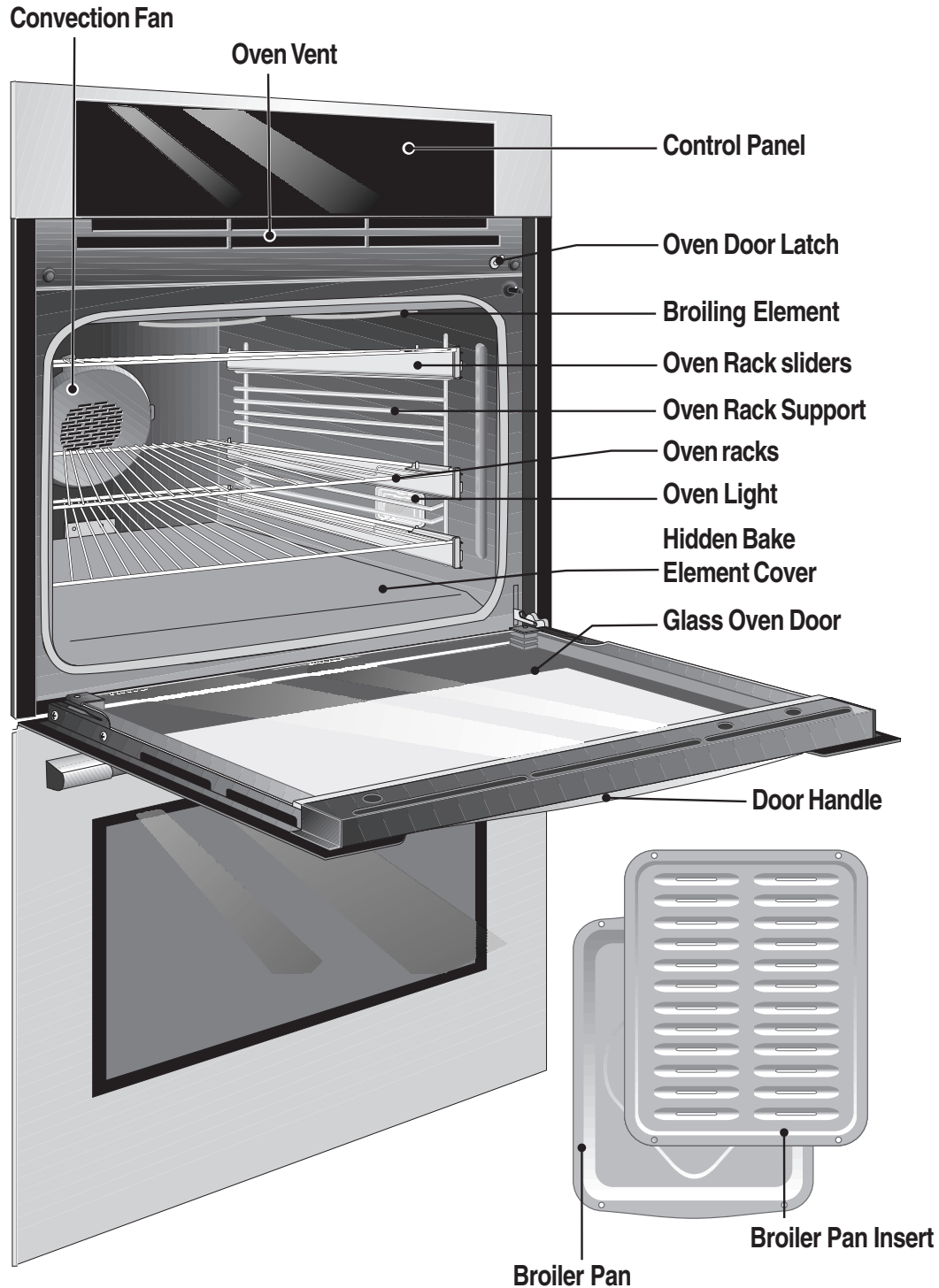

8 Getting Started

BEFORE SETTING OVEN CONTROLS

Oven Vent Location

The oven is vented **under upper control panel** for the upper oven and **between the doors** for the lower oven. When the oven is on, warm air is released through the vent. This venting is necessary for proper air circulation in the oven and good baking results.

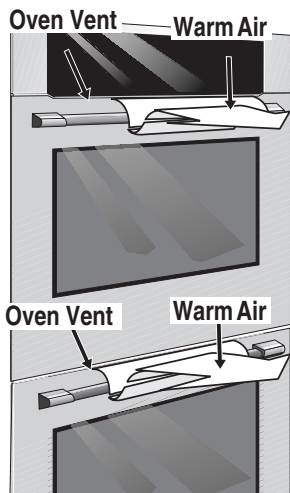

Installing Oven Rack Supports

ALWAYS INSTALL OVEN RACK SUPPORT BEFORE TURNING ON THE OVEN (WHEN THE OVEN IS COOL).

To install oven rack support, insert the support tabs in the holes located on the oven inside side as shown below. **To remove the oven rack support** for a self-clean cycle, pull up the support to disengage the tabs from the oven. If the rack supports are not removed, the self-clean cycle won't start. Always remove the left side support first.

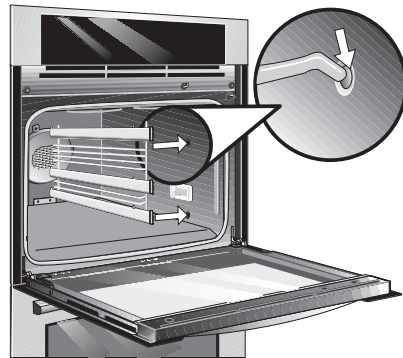

Removing and Replacing Oven Racks

ALWAYS ARRANGE OVEN RACKS WHEN THE OVEN IS COOL (PRIOR TO OPERATING THE OVEN).

Always use oven mitts when using the oven.

To remove an oven rack, pull the rack forward. Lift up the rack off the oven rack slider. **To install an oven rack**, locate the two pinholes in the small plates at the front corners of the rack. Place the rack on the side sliders and drop the pin holes over the pins on the sliders.

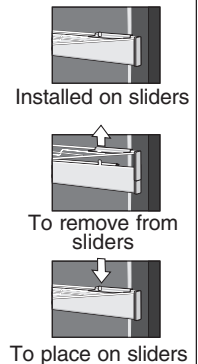
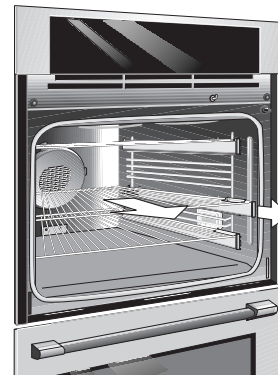

Pull oven rack forward and lift it up off the oven rack slider.

Arranging Oven Racks

ALWAYS ARRANGE OVEN RACKS WHEN THE OVEN IS COOL (PRIOR TO OPERATING THE OVEN).

To bake on a single rack, place the rack in position 3. **To bake on 2 racks**, place the racks in position 2 and 7. To bake on 3 racks, place the racks in position 1, 3 and 7.

RECOMMENDED RACK POSITIONS FOR BROILING, BAKING & ROASTING

Food	Rack Position
Broiling meats, chicken or fish	6 or 7
Cookies, cakes, pies & muffins	3 or 4
Frozen pies, angel food cake, yeast, bread, casseroles, small cuts of meat or poultry	2
Turkey, roast or ham	1

Note: Always use caution when removing food.

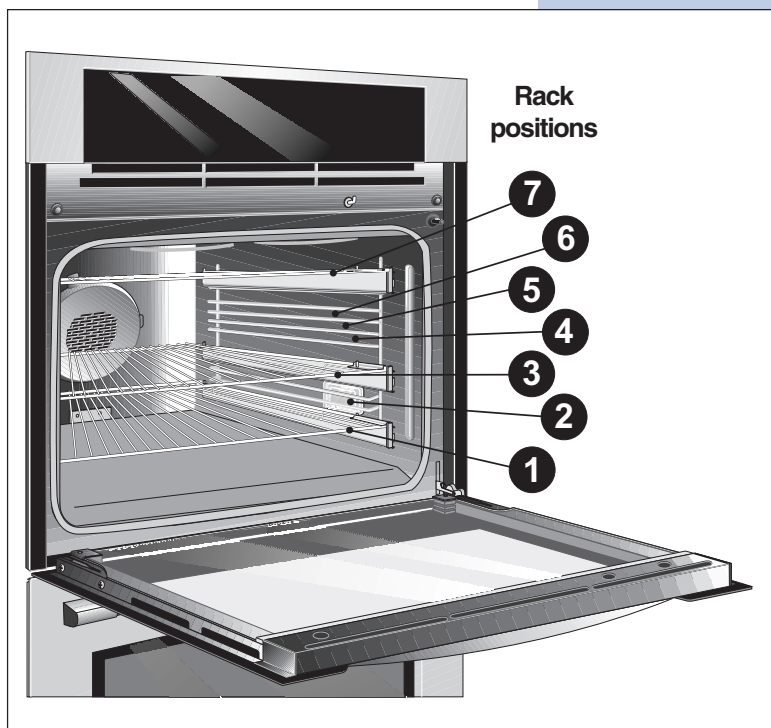

Baking Layer Cakes with 1 or 2 Oven Racks

For best results when baking cakes or cookies using 2 oven racks, place cookware on rack positions 2 and 7 (see figure 1). For best results when using a single oven rack, place cookware on rack position 3 (see figure 2).

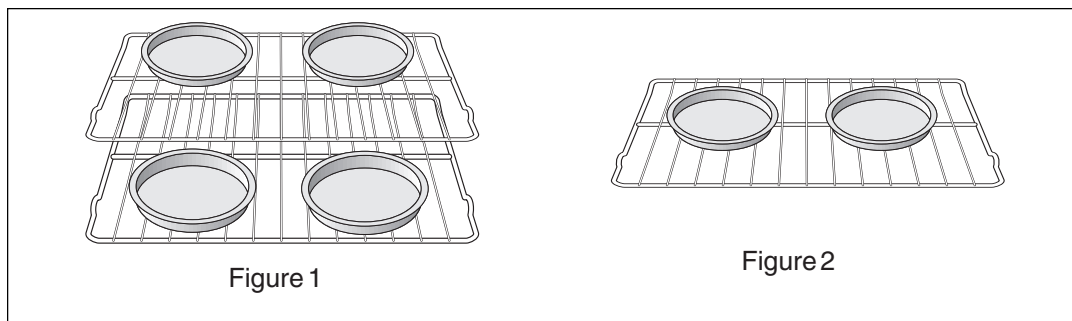

Air Circulation in the Oven

For best air circulation and baking results allow 2-4" (5-10 cm) around the cookware for proper air circulation and be sure pans and cookware do not touch each other, the oven door, sides or back of the oven cavity. The hot air must be able to circulate around the pans and cookware in the oven for even heat to reach around the food.

10 Setting Oven Controls

CONTROL PAD FUNCTIONS

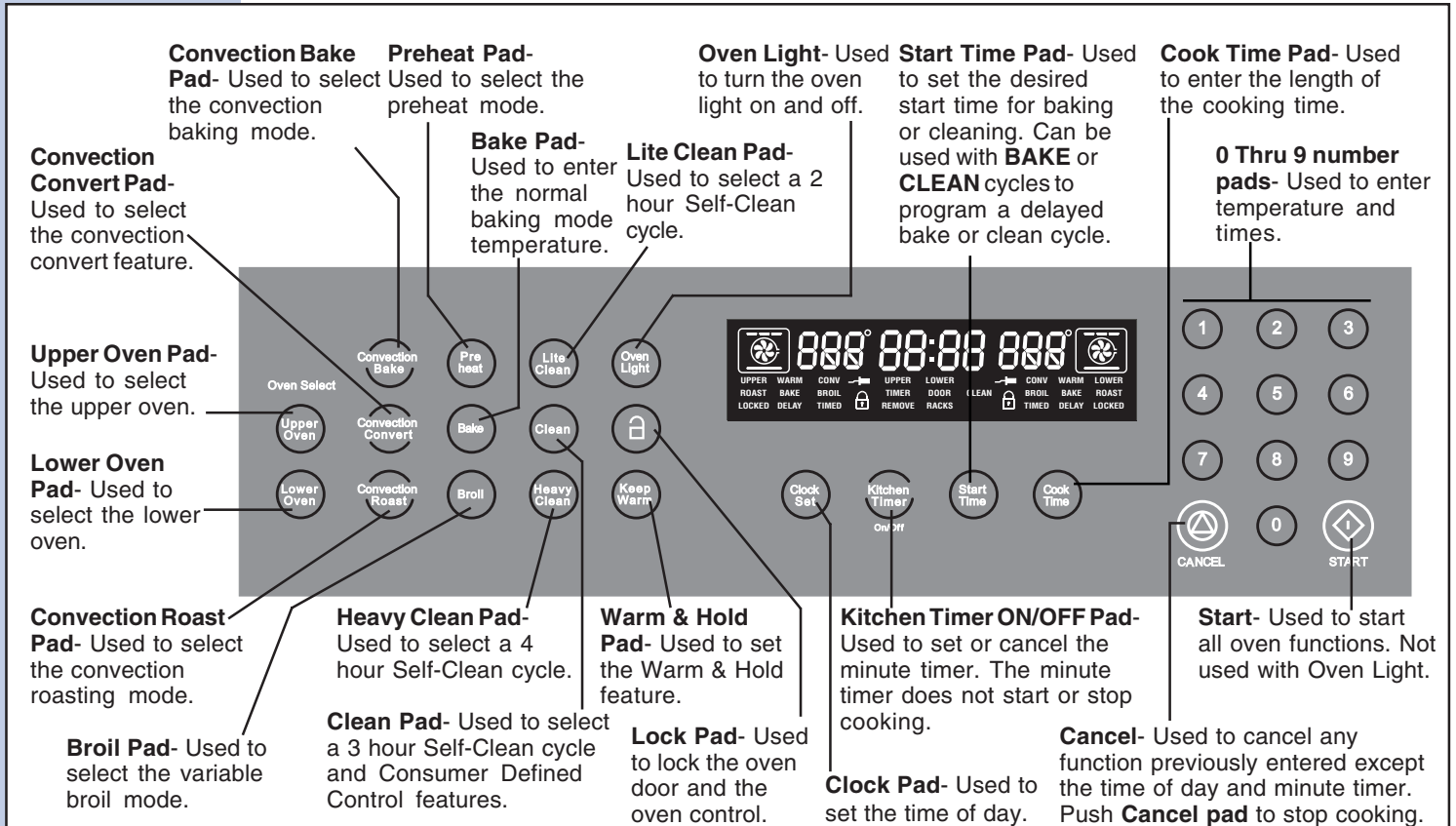

Read the instructions carefully before using the oven. For satisfactory use of your oven, become familiar with the various functions of the oven as described below. **Note:** The graphics on your timer looks like one of those shown. Both are operating the same way.

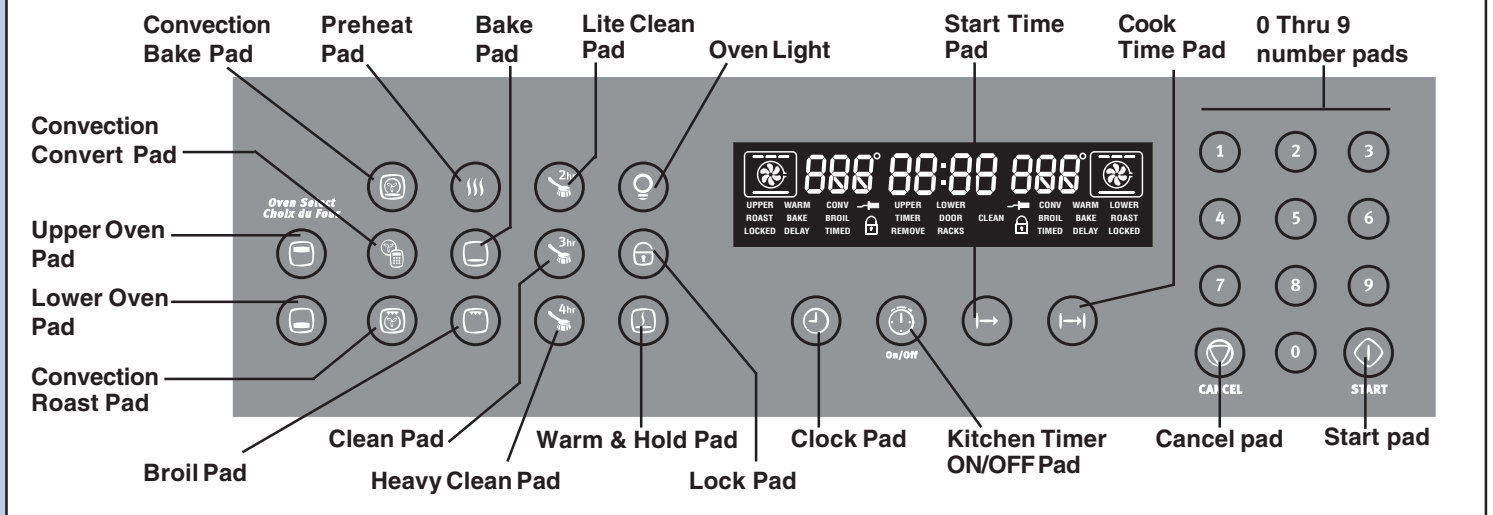

Note: See illustration above for pad description.









SETTING THE CLOCK







The  or  pad is used to set the clock. The clock may be set for 12 or 24 hour time of day operation. The clock is preset at the factory for the 12 hour operation. When the wall oven is first plugged in or when the power supply to the wall oven has been interrupted, the display will flash with "PF" (power failure, See Figure 1).

When "PF" appears in the display, press  or . A beep will sound and "PF" will disappear.

To set the clock (example below for 1:30):

1. Press  or . "CLO" and the current time of day will appear in the display (Figure 2).
2. Press    pads to set the time of day to 1:30 (Figure 3).
Press . The time of day will appear in the display (Figure 4).

Changing between 12 or 24 hour time of day display:

1. Press and hold  or  for 6 seconds (Figure 3). "CLO" and the current time of day will appear in the display (Figure 4). A beep will sound and "12h" (Figure 5) or "24h" (Figure 6) will appear in the display.
3. Press  or  to switch between the 12 and 24 hour time of day display. The display will show either "12h" (Figure 5) or "24h" (Figure 6).
4. Press  to accept the change or press  or  to reject the change.
5. Reset the correct time as described in **To set the Clock** above. Please note that if the 24 hour time of day mode was chosen, the clock will now display time from 0:00 through 23:59 hours.

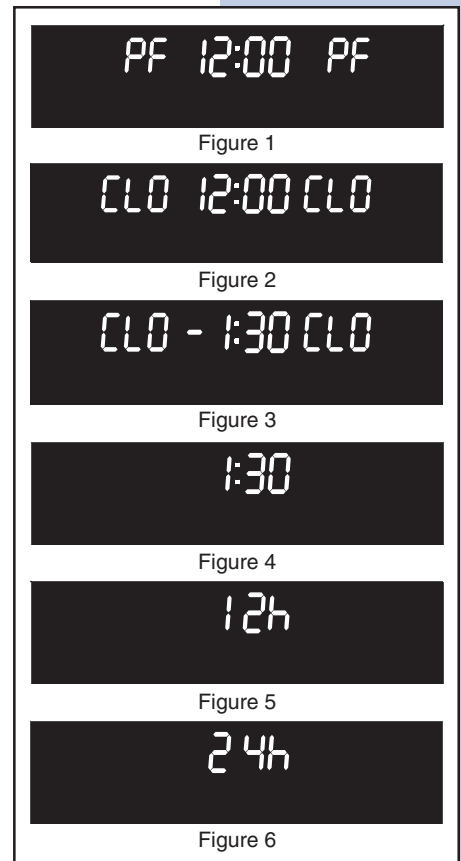

12 Setting Oven Controls

SETTING CONTINUOUS BAKE OR 12 HOUR ENERGY SAVING





The  or  and  or  pads control the Continuous Bake or 12 Hour Energy Saving features. The oven control has a factory preset built-in 12 Hour Energy Saving feature that will shut off the oven if the oven control is left on for more than 11 hours and 59 minutes. The oven can be programmed to override this feature for Continuous Baking.



Figure 1



Figure 2









Figure 3





Figure 4







To set the control for Continuous Bake or 12 Hour Energy Saving

1. Press and hold  or  for 6 seconds. "--:--" will appear, "TIMER" will flash and a beep will be heard (Figure 1). After 6 seconds a beep will sound and "12h" (Figure 2) or "--h" (Figure 3) appears in the display.
2. Press  or  to switch between the 12 Hour Energy Saving and continuous bake features. Note: "12h" in the display indicates the control is set for the 12 Hour Energy Saving mode and "--h" indicates the control is set for the Continuous Bake feature (Figures 2 and 3).
3. Press  to accept the change (Figure 4; display will return to time of day) or press  or  to reject the change.



SETTING THE KITCHEN TIMER

The  or  pad controls the Timer feature. The Timer serves as an extra timer in the kitchen that will beep when the set time has run out. It does not start or stop cooking. The Timer feature can be used during any of the other oven control functions, except during a self clean operation.

To set the Timer (example for 5 minutes):

1. Press  or . "-:--" will appear and "TIMER" will flash in the display (Figure 1).
2. Press the number pads to set the desired time in the display (example ). Press . The time will begin to countdown with "5:00" and "TIMER" will stay in the display (Figure 2). Note: If  is not pressed the timer will return to the time of day.
3. When the set time has run out, "End" will show in the display (Figure 3). The clock will sound with 3 beeps every 15 seconds until  or  is pressed.

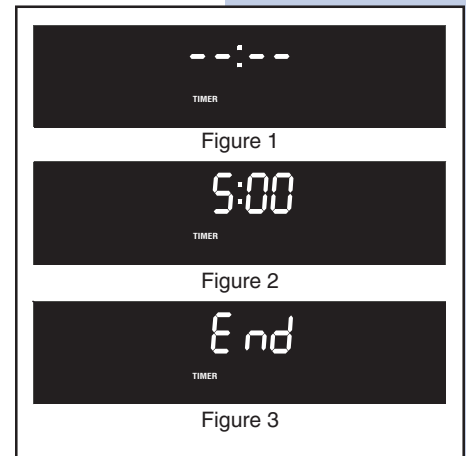

To cancel the Timer before the set time has run out:

Press  or . The display will return to the time of day.







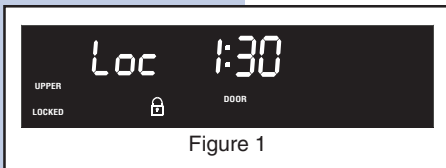

14 Setting Oven Controls

SETTING OVEN LOCKOUT FEATURE







The  or  pad controls the Oven Lockout feature. The Oven Lockout feature automatically locks the oven door and the oven control. It does not disable the clock, the kitchen timer or the interior oven lights. The oven can be locked individually.



To activate the Oven Lockout feature on the Upper Oven:





1. Press  or . (Note: To Lock the lower oven instead of the upper oven, press  or  at this time.)
2. Press and hold  or  for 3 seconds.
3. After 3 seconds a beep will sound, "DOOR", "LOCKED" will flash and "UPPER", "Loc" and  will appear in the display (Figure 1). Once the oven door is locked the "DOOR" and "LOCKED" indicator will stop flashing and remain on.

To reactivate normal Upper Oven operation:

1. Press  or . (Note: To unlock the lower oven instead of the upper oven, press  or  at this time.)
2. Press and hold  or  for 3 seconds. A single beep will sound. The "UPPER", "Loc" and  will disappear from the display. "DOOR" and "LOCKED" will start flashing and continue to flash until the oven door has completely unlocked.
3. The upper oven is again fully operational.



Note: Because you can set the oven lockout individually, the lower oven can be used when the upper oven lockout feature is on.

SETTING TEMPERATURE DISPLAY — FAHRENHEIT OR CELSIUS:





The  or  and  or  pads control the Fahrenheit or Celsius temperature display modes. The oven control can be programmed to display temperatures in Fahrenheit or Celsius. The oven has been preset at the factory to display in Fahrenheit.

Note: Both ovens will be changed at the same time.

To change display from Fahrenheit to Celsius or Celsius to Fahrenheit:

1. Press  or  for 6 seconds. A beep will sound, "---" will appear, "UPPER", "BROIL" will flash in the display (Figure 1). After 6 seconds a beep will be heard and "F" (Figure 2) or "C" (Figure 3) will appear in the display.



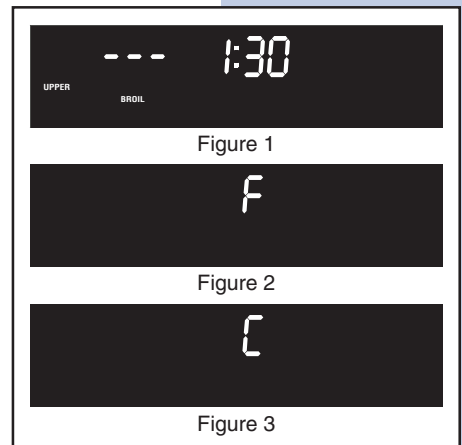

If "F" appears, the display is set to show temperatures in Fahrenheit (Figure 2). If "C" appears, the display is set to show temperatures in Celsius (Figure 3).

2. Press  or  to switch between Fahrenheit or Celsius display modes. The display will show either "F" (Figure 2) or "C" (Figure 3).
3. Press  to accept the change or press  or  to reject the change.





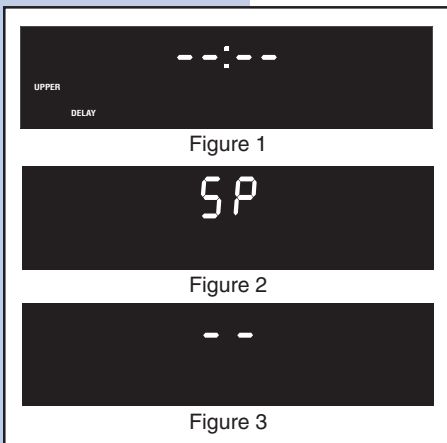

16 Setting Oven Controls

SETTING SILENT CONTROL OPERATION



The  or  and  or  pads control the Silent Control operation feature. The Silent Control operation feature allows the oven control to be operated without sounds or beeps whenever necessary. If desired the control can be programmed for silent operation and later returned to operating with all the normal sounds and beeps.





To change control from normal sound operation to silent control operation:

1. Press and hold  or  for 6 seconds. A beep will sound, "-:--" will appear, "UPPER" and "DELAY" will flash in the display (Figure 1). After 6 seconds, a single beep will sound and "SP" (speaker; Figure 2) or "--" (silent; Figure 3) appears in the display.
2. Press  or  to switch between normal sound operation and silent operation mode.











If "SP" appears (Figure 2), the control will operate with normal sounds and beeps. If "--" appears (Figure 3), the control is in the silent operation mode.

3. Press  to accept the change or press  or  to reject the change.



PREHEATING

The  or  pad controls the Preheat feature. The Preheat feature will bring the oven up to temperature and then indicate when to place the food in the oven. Use this feature when recipes call for preheating. Preheating is not necessary when roasting or cooking casseroles. The oven can be programmed to preheat at any temperature between 170°F to 550°F (77°C to 288°C).

To set the Preheat temperature on the Upper Oven for 350°F:









1. Arrange the interior oven racks.
2. Press  or . (Note: To use the lower oven instead of the upper oven, press  or  at this time.)
3. Press  or . "---" will appear, "UPPER" and "BAKE" will flash in the display (Figure 1).
4. Press , , . "350" will appear in the display (Figure 2).
5. Press . "UPPER" and "BAKE" stop flashing and remain in the display. "PRE" will appear in the display. The oven icon appears in the display showing the bake and broil elements cycling. (Figures 3 and 4).

Note: After the oven has reached the desired temperature (this example, 350°F) a beep will be heard indicating this is time to **PLACE FOOD IN THE OVEN** and the display will show "350°" (figure 5). The oven will continue to operate in a Bake mode.

Press  or  when baking is completed or to cancel the preheat feature.

To change Preheat temperature while oven is preheating (example changing from 350 to 425°F):

If it is necessary to change the preheat temperature while the oven is preheating to the original temperature:

1. While preheating, press  or . "---" will appear, "UPPER" and "BAKE" will flash, the oven icon remain in the display (Figure 6).
2. Enter the new preheat temperature. Press , , . "425°" will appear in the display (Figure 7).
3. Press . "UPPER" and "BAKE" stop flashing and remain in the display. "PRE" will also appear in the display until the desired temperature (here, 425°F) is reached. At that time the display will show "425°" (Figure 8). A long beep will sound once the oven temperature reaches 425°F.
4. When baking is completed press  or .

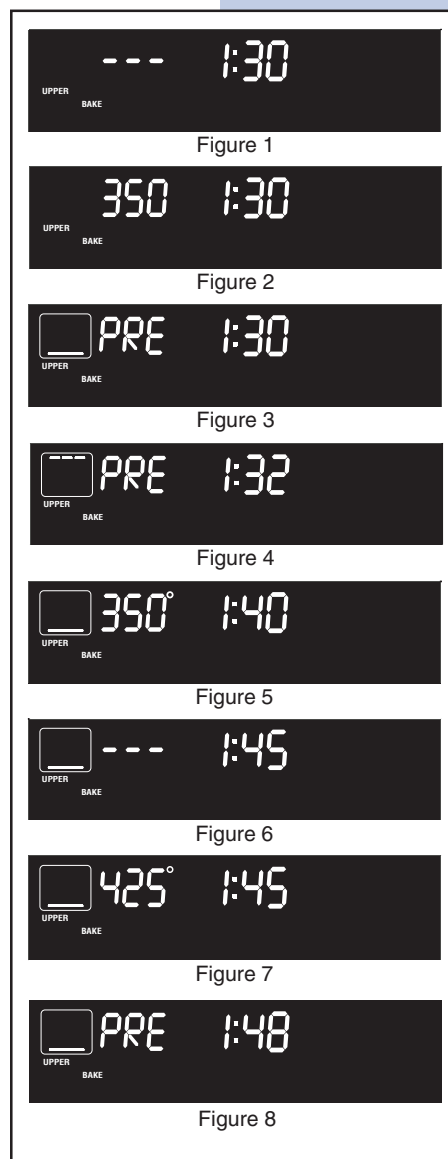

18 Cooking Instructions

BAKING



The  or  pad controls normal baking. If preheating is necessary, refer to the Preheat Feature for instructions. The oven can be programmed to bake at any temperature from 170° F to 550° F (77°C to 288°C).



Figure 1



Figure 2



Figure 3















Figure 4









Figure 5

To set the Bake Temperature to 350°F on the Upper Oven:

1. Arrange interior oven racks and place food in oven.
2. Press  or . (Note: To use the lower oven instead of the upper oven, press  or  at this time.)
3. Press  or , "---" will appear, "UPPER" and "BAKE" will flash in the display (Figure 1).
4. Press , , . "350°" will appear, "UPPER" and "BAKE" continue flashing in the display (Figure 2).
5. Press . "UPPER" and "BAKE" stop flashing and the oven icon will appear in the display (Figure 3). A beep will sound once the oven temperature reaches 350° F.

Pressing  or  will cancel the Bake feature at any time.





To change the Bake Temperature (example changing from 350° to 425°F):

1. After the oven has already been set to bake at 350°F and the oven temperature needs to be changed to 425°F, press  or  (Figure 4), "---" will appear, "UPPER" and "BAKE" start flashing in the display.
2. Press , , . "425°" will appear in the display (Figure 5).
3. Press . A beep will sound once the oven temperature reaches 425° F.

Note: If the oven was recently heated from prior cooking and has remaining heat, the bake element symbol may not show in the display immediately.

Baking Problems

For best cooking results preheat the oven before baking cookies, breads, cakes, pies or pastries, etc... There is no need to preheat the oven for roasting meats or baking casseroles. The cooking times and temperatures needed to bake a product may vary slightly from your previous appliance.

Baking Problems and Solutions Chart		
Baking Problems	Causes	Solutions
<p>Cookies and biscuits burn on the bottom.</p> 	<ul style="list-style-type: none"> • Cookies and biscuits put into the oven before the preheating time is completed. • Oven rack overcrowded or rack position too low. • Dark pan absorbs heat too fast. 	<ul style="list-style-type: none"> • Allow oven to preheat to the selected temperature before placing food in oven. • Choose pan sizes that will permit 5.1 cm to 10.2 cm (2" to 4") of air space on all sides when placed in the oven. • Use a medium-weight aluminum baking sheet.
<p>Cakes too dark on top or bottom.</p> 	<ul style="list-style-type: none"> • Cakes put into the oven before preheating time is completed. • Rack position too high or low. • Oven too hot. 	<ul style="list-style-type: none"> • Allow oven to preheat to the selected temperature before placing food in the oven. • Use proper rack position for baking needs. • Set oven temperature 25°F/12°C lower than recommended.
<p>Cakes not done in the center.</p> 	<ul style="list-style-type: none"> • Oven too hot. • Incorrect pan size. • Pan not centered in oven. 	<ul style="list-style-type: none"> • Set oven temperature 25°F/12°C lower than recommended. • Use pan size suggested in recipe. • Use proper rack position and place pan so there is 5.1 cm to 10.2 cm (2" to 4") of space on all sides of pan.
<p>Cakes not level.</p> 	<ul style="list-style-type: none"> • Wall oven not level. • Pan too close to oven wall or rack overcrowded. • Pan warped. 	<ul style="list-style-type: none"> • Place a marked glass measuring cup filled with water on the center of the oven rack. If the water level is uneven, refer to the installation instructions for leveling the wall oven. • Be sure to allow 5.1 cm to 10.2 cm (2" to 4") of clearance on all sides of each pan in the oven. • Do not use pans that are dented or warped.
<p>Foods not done when cooking time is up.</p> 	<ul style="list-style-type: none"> • Oven too cool. • Oven overcrowded. • Oven door opened too frequently. 	<ul style="list-style-type: none"> • Set oven temperature 25°F/12°C higher than suggested and bake for the recommended time. • Be sure to remove all pans from the oven except the ones to be used for baking. • Open oven door only after shortest recommended baking time.

20 Cooking Instructions

CONVECTION BAKING

Benefits of Convection Bake:

- Some foods cook up to 30% faster, saving time and energy.
- Multiple rack baking.
- No special pans or bakeware needed.

Foods for CONVECTION BAKE pad *Decrease normal cook time by:

Frozen foods, pies, 15-25 % pastries and pizza
Refrigerator biscuits 15-30 %
Rolls & Breads 20-25%
Fresh Pies/Pastries 10-20 %

Begin with the maximum reduction in cook times and adjust as needed.



*Recommended reduction in cook times based on brands of food items tested. Cook times may vary with your specific brand of food item.

The convection oven uses a fan located in the rear wall of the oven to circulate heated air around the food to be cooked. The controlled air flow pattern quickly seals the food surface retaining the natural juices and flavour. This method of cooking enables you to obtain the best culinary results when baking, thawing, dehydrating and roasting foods.

Convection notes:

1. Batch cooking is more convenient with better results.
2. Defrosting is quicker in convection mode when compared to regular radiant cooking.
3. Remember to use tested recipes with times adjusted for convection baking/roasting when using the convection mode. Times may be reduced by as much as 30% when using the convection feature.

Setting Convection Bake











The  or  pad controls the Convection Bake feature. Use the Convection Bake feature when cooking speed is desired. The oven can be programmed for Convection baking at any temperature between 170° F (77° C) to 550° F (288° C).

Convection baking uses a fan to circulate the oven's heat evenly and continuously within the oven. This improved heat distribution allows for fast, even cooking and browning results. It also gives better baking results when using 2 or 3 racks at the same time. Breads and pastries brown more evenly. Most foods cooked in a standard oven will cook faster and more evenly with Convection Bake.

General Convection Bake Instructions

1. When using Convection Bake, decrease your normal cooking times as shown aside. Adjust the cook time for desired doneness as needed. Time reductions will vary depending on the amount and type of food to be cooked. Biscuits should be baked on pans with no sides or very low sides to allow heated air to circulate around the food. Food baked on pans with a dark finish will cook faster.
2. Preheating is not necessary when cooking casseroles with Convection Bake.
3. When using Convection Bake with a single rack, place oven rack in position 3. If cooking on 2 racks, place the oven racks in positions 2 and 7. And to cook on 3 racks, place the oven racks in positions 1, 3 and 7.

To set the oven for Convection Bake and temperature to 350°F on the Upper Oven:

1. Arrange interior oven racks and place food in oven.
2. Press  or . (Note: To use the lower oven instead of the upper oven, press  or  at this time.)
3. Press  or . "---" will appear, "UPPER", "BAKE" and "CONV" will flash in the display (Figure 1).
4. Press , , . "UPPER", "BAKE", "CONV" will continue to flash and "350°" will appear in the display (Figure 2).
5. Press . The oven icon will appear and the rotating fan will start running in the display. The bake (Figure 3), broil (Figure 4) and convection (Figure 5) element icons will show intermittently in the display indicating which element is on to help the oven reaching the desired temperature. A beep will sound once the oven temperature reaches 325° F (adjusted temperature).

Note: The convection fan will start AS SOON AS the oven is set for Convection Bake.

Press  or  to cancel Convection Bake at any time.

Note: As soon as the  pad is pressed the set temperature will be decreased by 25°F or 14°C.

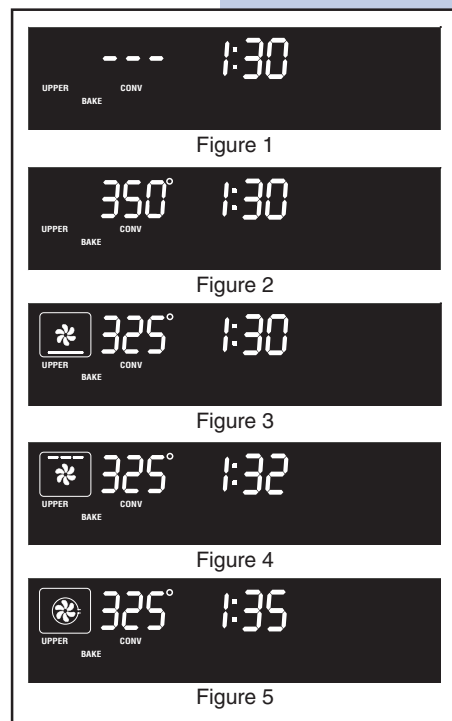

22 Cooking Instructions

CONVECTION ROASTING

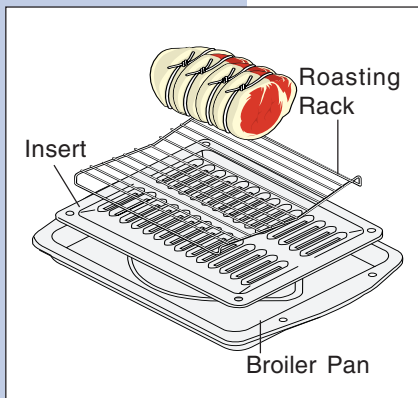

When preparing meats for convection roasting, use the broiler pan and insert along with the roasting rack. The broiler pan will catch grease spills and the insert will help prevent spatters. The roasting rack will allow the heat to circulate around the meat.



CAUTION To prevent food from contacting the broil element and to prevent grease spattering, **DO NOT** use the roasting rack when broiling.

1. Place oven rack on bottom rack position.
2. Place the insert in the broiler pan. The roasting rack fits on the insert allowing the heated air circulate under the food for even cooking and helps to increase browning on the underside. Make sure the roasting rack is securely seated on the insert in the broiler pan. **DO NOT** use the broiler pan without the insert or cover the broiler pan insert with aluminum foil.
3. Position food (fat side up) on the roasting rack.
4. Place the broiler pan on the oven rack.

Note: Always pull the rack out to the stop position before removing food.







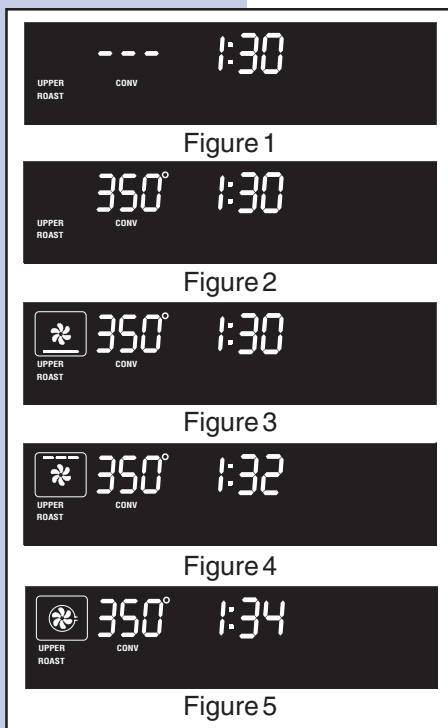





NOTE: For best convection roasting results, use the broiler pan, broiler pan insert and roasting rack.

Setting Convection Roast



The  or  pad controls the Convection Roast feature. The oven can be programmed to Convection Roast at any temperature between 170°F (77°C) to 550°F (288°C) (The example below is for 350°F).





To Set the Upper Oven to Convection Roast and Temperature to 350°F:

1. Arrange interior oven racks and place food in oven.
2. Press  or . (Note: To use the lower oven instead of the upper oven, press  or  at this time.)
3. Press  or . "---" will appear and "UPPER", "ROAST" and "CONV" will flash in the display (Figure 1).
4. Press , , . "350°" will appear in the display (Figure 2).
5. Press . "UPPER", "ROAST" and "CONV" will stop flashing and the oven icon will appear in the display. The bake (Figure 3) and broil (Figure 4) and convection (Figure 5) element icons will show intermittently in the display indicating which element is on. A beep will sound when the desired temperature is reached.
6. Press  or  to cancel convection roast at any time.











SETTING CONVECTION CONVERT FEATURE

The  or  pad is used to automatically convert a standard **baking** recipe to convection baking. When set properly, this feature is designed to display the actual converted (reduced) temperature in display.

Convection Convert may **ONLY** be used with a **Bake**, **Timed Bake** or a **Delay Start** (Delayed Timed Bake) setting. When used with a Timed Bake or a Delayed Timed Bake setting, the Convection Convert feature will display a "**CF**" for check food when the bake time is approximately 75% complete. At this time the oven control will sound 3 long beeps at regular intervals (if the cook time is programmed to a duration greater than 19 minutes) until baking is finished. When the bake time has completely finished the control will display "**End**" and

will sound 3 long beeps every 30 seconds until the  or  pad is pressed.

To Set a Convection Convert (Bake) feature to automatically adjust oven temperature (example: setting oven for 350°F):

1. Arrange interior oven racks and place food in oven.
2. Press  or . (Note: To use the lower oven instead of the upper oven, press  or  at this time).
3. Press  or , "---" will appear, "UPPER" and "BAKE" will flash in the display (Figure 1).
4. Press , , . "350°" will appear in the display (See Figure 2). If a Timed Bake or a Delayed Start (Delayed Timed Bake) is desired, enter the times now.
5. Press  or . "UPPER", "BAKE", "CONV" and the oven temperature **adjustment** will appear in the display (for this example it is 325°F). A beep will sound once the **adjusted** oven temperature is reached (Figure 3).

Note: The oven icon will show a rotating fan within the square with the bake (Figure 3), broil (Figure 4) and convection (Figure 5) elements cycling in the display.

Press  or  to cancel Convection feature at any time.

Note: When Convection Convert is pressed the set temperature is decreased by 25°F (14°C) (see figures 2 and 3).

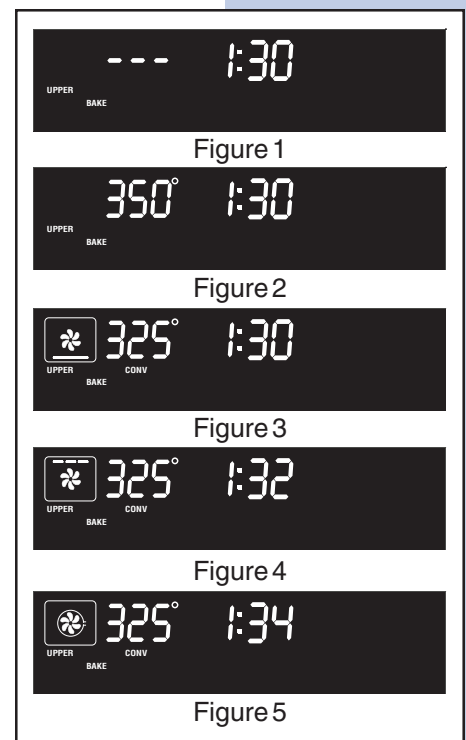

24 Cooking Instructions

SETTING DELAYED BAKE OR DELAYED CONVECTION BAKE OR DELAYED CONVECTION ROAST









The  or  or  and  ( or  or  and ) pads control the Timed Bake feature. The automatic timer of the Delayed Bake feature will turn the oven **on** at the time you select in advance. **NOTE:** If your clock is set for normal 12 hour display mode the Delayed Time Bake feature can never be set to start more than 12 hours in advance.



Figure 1



Figure 2



Figure 3



Figure 4





















Figure 5



Figure 6









To program the upper oven for a **DELAYED BAKE** start time and to shut off **MANUALLY** (example for upper oven baking at 350°F, starting at 5:30):

1. Be sure the clock is set for the correct time of day.
2. Arrange interior oven rack(s) and place the food in the oven.
3. Press  or . (Note: To use the lower oven instead of the upper oven, press  or  at this time.)
4. Press  or , "UPPER", "BAKE" will flash and "---" will appear in the display (Figure 1).
5. Press , , . "UPPER" and "BAKE" will continue to flash and "350°" will appear in the display (Figure 2).
6. Press . "350°", "UPPER" and "BAKE" stop flashing and remain on in the display (Figure 3).
7. Press  or . "UPPER", "DELAY" start flashing and "-:--" will appear in the display (Figure 4).
8. Enter the desired start time using the number pads , ,  (Figure 5).
9. Press . When Delayed Bake starts, the set start time will disappear and the current time of day will appear in the display (Figure 6).
10. When the desired start time is reached, the oven icon will appear in display and the oven will start to bake at the previous selected temperature.















Press  or  when baking has completed or at any time to cancel the Delayed Bake feature.



CAUTION Use caution with the **DELAYED BAKE**, **TIMED BAKE** or **DELAYED TIME BAKE** features. Use the automatic timer when cooking cured or frozen meats and most fruits and vegetables. Foods that can easily spoil such as milk, eggs, fish, meat or poultry, should be chilled in the refrigerator first. Even when chilled, they should not stand in the oven for more than 1 hour before cooking begins, and should be removed promptly when cooking is completed. Eating spoiled food can result in sickness from food poisoning.

SETTING TIMED BAKE OR TIMED CONVECTION BAKE OR TIMED CONVECTION ROAST



The  or  or  and  ( or  or  and ) pads control the Timed Bake feature. The automatic timer of the Timed Bake feature will turn the oven OFF after cooking for the desired amount of time you select in advance.

To program the upper oven to begin baking immediately and to shut off automatically: (example below to BAKE at 350°F for 30 minutes):



1. Be sure the clock is set for the correct time of day.
2. Arrange interior oven rack(s) and place the food in the oven.
3. Press  or . (Note: To use the lower oven instead of the upper oven, press  or  at this time.)
4. Press  or , "UPPER", "BAKE" will flash and "---" will appear in the display (Figure 1).
5. Press , , . "UPPER" and "BAKE" will continue to flash and "350°" will appear in the display (Figure 2).
6. Press . "350°", "UPPER" and "BAKE" stop flashing and remain on in the display (Figure 3).
7. Press  or . "UPPER" and "TIMED" start flashing and "-:-:-" will appear in the display (Figure 4).
8. Enter the desired baking time by pressing , . "-:-:30" will appear in the display (Figure 5). Note: Baking time can be set for any amount of time between 1 minute to 11 hours and 59 minutes.
9. Press . The display returns to the time of day (Figure 6).

Note: After the Timed Bake feature has been activated, press  or 

to display the bake time remaining in the Timed Bake mode. Once Timed Bake has started baking, a beep will sound when the oven temperature reaches the set temperature.

Press  or  when baking has finished or at any time to cancel the Timed Bake feature.

When the timed bake finishes:

1. "End" and the time of day will show in display. The oven will shut off automatically (Figure 7).
2. The control will beep 3 times. The control will continue to beep 3 times every 30 seconds until  or  (or any other key) is pressed.

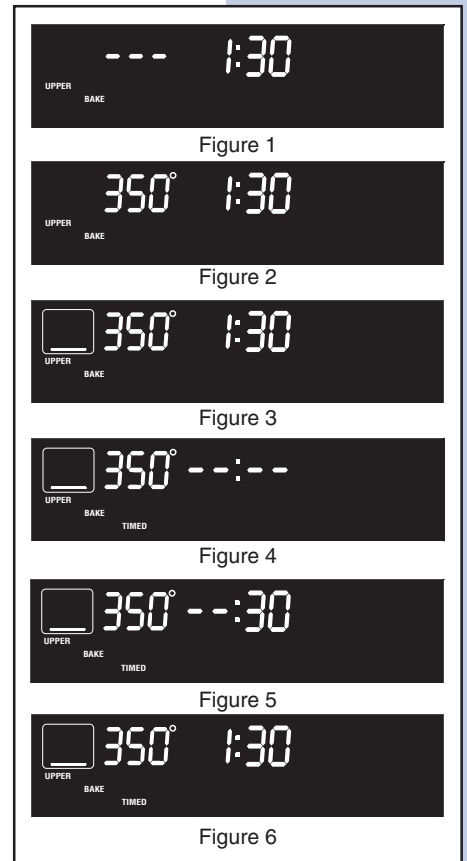

26 Cooking Instructions





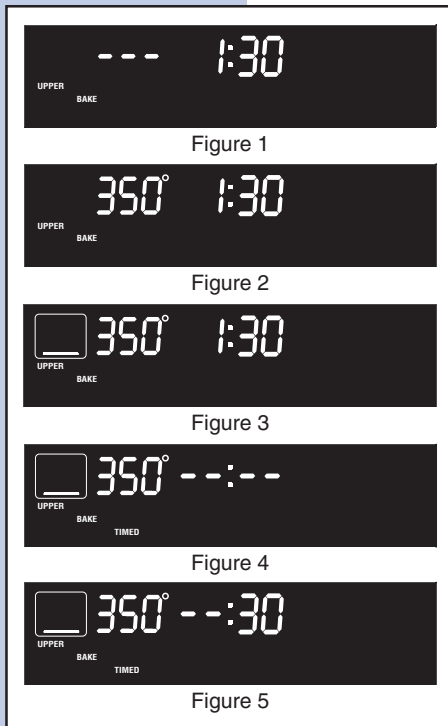

SETTING DELAYED TIMED BAKE OR DELAYED TIMED CONVECTION BAKE OR DELAYED TIMED CONVECTION ROAST



The **Bake** or **Convection Bake** or **Convection Roast**, **Cook Time** and **Start Time** (□ or □) or □, □ and □) pads control the Delayed Time Bake feature. The automatic timer of the Delayed Time Bake will turn the oven **on and off** at the time you select in advance. **NOTE:** If your clock is set for normal 12 hour display mode the Delayed Time Bake feature can never be set to start more than 12 hours in advance.





To program the oven for a delayed BAKE start time and to shut off automatically (example for upper oven baking at 350°F, starting at 5:30 for 30 minutes):

1. Be sure that the clock is set with the correct time of day.
2. Arrange interior oven rack(s) and place the food in the oven.
3. Press **Upper Oven** or □. (Note: To use the lower oven instead of the upper oven, press **Lower Oven** or □ at this time.)
4. Press **Bake** or □. "UPPER", "BAKE" will flash and "---" will appear in the display (Figure 1).
5. Press **3**, **5**, **0**. "UPPER", "BAKE" will continue to flash and "350°" will appear in the display (Figure 2).
6. Press **START**. "350°", "UPPER" and "BAKE" will stop flashing and remain in the display. (Figure 3).
7. Press **Cook Time** or □. "UPPER" and "TIMED" will start flashing and "- -:--" will appear in the display (Figure 4).
8. Enter the desired baking time using the number pads by pressing **3**, **0**. "- -:30" will appear in the display (Figure 5). Note: Baking time can be set for any amount of time from 1 minute to 11 hours and 59 minutes.

9. Press . The display will return to the time of day (Figure 1).
10. Press  or . "UPPER", "DELAY" start flashing and "--:--" will appear in the display (Figure 2).
11. Enter the desired start time using the number pads , ,  (Figure 3).
12. Press . The current time of day will appear in the display (Figure 4).
13. When the desired start time is reached, the oven icon will appear in display and the oven will start to bake at the previously selected temperature.

Press  or  when baking has completed or at any time to cancel the Delayed Time Bake feature.

When the set bake time runs out:

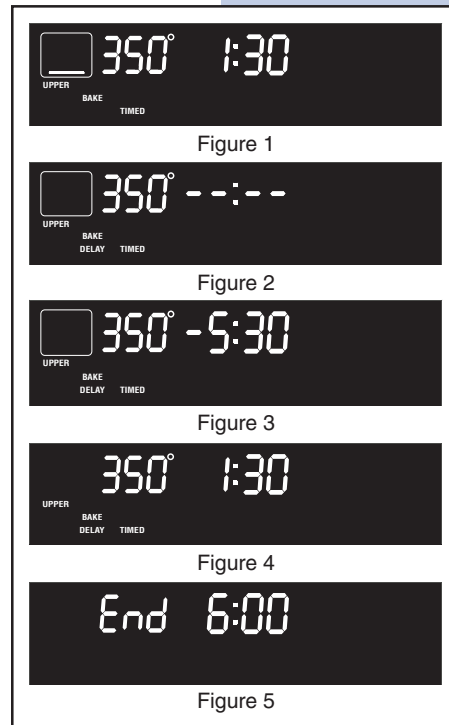

1. "End" will appear in the display and the oven will shut off automatically (Figure 5).
2. The control will beep 3 times. The control will continue to beep 3 times every 30 seconds until  or  (or any other key) is pressed.



CAUTION Use caution with the **TIMED BAKE** or **DELAYED TIME BAKE** features. Use the automatic timer when cooking cured or frozen meats and most fruits and vegetables. Foods that can easily spoil such as milk, eggs, fish, meat or poultry, should be chilled in the refrigerator first. Even when chilled, they should not stand in the oven for more than 1 hour before cooking begins, and should be removed promptly when cooking is completed. Eating spoiled food can result in sickness from food poisoning.

28 Cooking Instructions







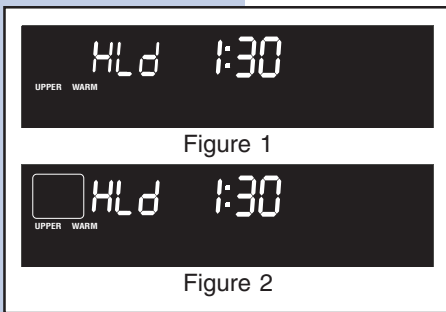

SETTING THE KEEP WARM FEATURE

The  or  pad turns ON the Keep Warm feature and will maintain an oven temperature of 170°F (77°C). The Keep Warm Hold feature will keep oven baked foods warm for serving up to 3 hours after cooking has finished. The Warm & Hold feature will automatically turn OFF after 3 hours. The Keep Warm feature may be used without any other cooking operations or can be used after cooking has finished using BAKE, CONVECTION BAKE, CONVECTION ROAST.

The Keep Warm feature may be used with TIMED BAKE if you wish to have the Keep Warm feature turn ON automatically when cooking has finished. The Timed Bake feature requires you to set the amount of cooking time. With this information the control can calculate the time when cooking will complete and can then start the Keep Warm feature automatically.





To set Keep Warm on the Upper Oven



1. Arrange interior oven racks and place food in oven.
2. Press  or . (Note: To use the lower oven instead of the upper oven, press  or  at this time.)
3. Press  or . "UPPER", "WARM" will flash and "HLd" will appear in the display (Figure 1).
Note: If no pad is touched within 25 seconds the request to turn ON Keep Warm feature will be cancelled.
4. Press . "UPPER", "WARM" will stop flashing, the oven icon and "HLd" will appear in the display (Figure 2).
5. To turn the Warm & Hold OFF at any time press  (or .

Note: The Warm & Hold feature will automatically turn OFF after 3 hours.

To set Keep Warm to turn ON automatically

1. Arrange interior oven racks and place food in oven. Set the oven properly for **Timed Bake** (see page 25, steps 1 to 9) or **Delayed Timed Bake** (see page 26-27, steps 1 to 12).
2. Press  or . "UPPER" and "WARM" will flash and "HLd" will appear in the display (Figure 1)
Note: If no pad is touched within 25 seconds the request to turn ON the Keep Warm feature and all functions previously programmed will be cleared.
3. Press . "UPPER" and "WARM" will stop flashing and remain in the display. Also the temperature programmed will appear in the display (Figure 2).
4. When the Timed Bake has finished, the Keep Warm mode will turn ON automatically. "350°", "BAKE" and "TIMED" will disappear. "HLd" will appear. "UPPER" and the oven icon will remain in the display (Figure 3).

Note: The Keep Warm feature will automatically turn OFF after 3 hours.

Pressing  or  at any time will stop all oven baking operations.

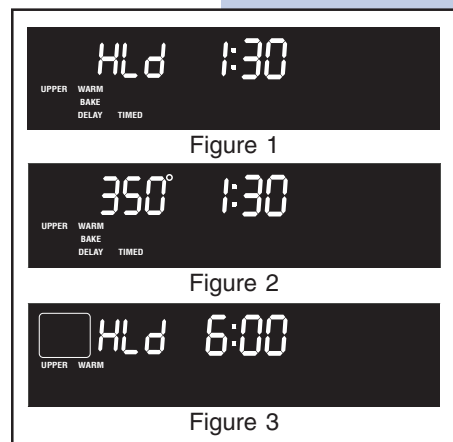

30 Cooking Instructions

BROILING

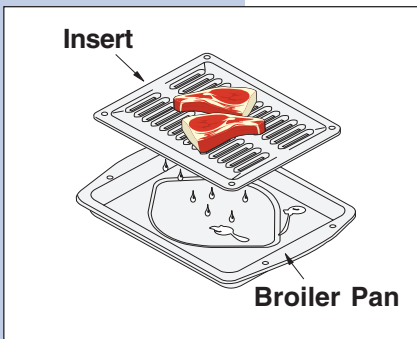

Broiling is a method of cooking tender cuts of meat by direct heat under the broil element of the oven.

Preheating

Preheating is suggested when searing rare steaks. (Remove the broiler pan before preheating. Foods will stick if placed on hot metal.) To preheat, set the control(s) to BROIL (see next page). Wait for the element to become red-hot, usually about 2 minutes. Preheating is not necessary when broiling meats well-done.

To Broil

Broil one side until the food is browned; turn and cook on the second side. Season and serve. Always pull the rack out to the "stop" position before turning or removing food.

Broiling Tips

The broiler pan and its insert allow dripping grease to drain and be kept away from the high heat of the broiler.

Broiling Times

Use the following table for approximate broiling times. Increase or decrease broiling times, or move the broiling pan to a different rack position to suit for doneness. If the food you are broiling is not listed in the table, follow the instructions provided in your cookbook and watch the item closely.



Food Item	Rack Position	Temp Setting	Cook Time		Doneness
			1st side	2nd side	
Steak 1" thick	5 or 6	550° F	6:00	4:00	Rare
	5 or 6	550° F	7:00	5:00	Medium
Pork Chops 3/4" thick	5 or 6	550° F	8:00	6:00	Well
Chicken - Bone In	4	450° F	20:00	10:00	Well
Chicken - Boneless	5 or 6	450° F	8:00	6:00	Well
Fish	5 or 6	500° F	13:00	n/a	Well
Shrimp	4	550° F	5:00	n/a	Well
Hamburger 1" thick	5 or 6	550° F	9:00	7:00	Medium
	4	550° F	10:00	8:00	Well

NOTE

DO NOT use the broiler pan without its insert. DO NOT cover the broiler pan insert with foil. The exposed grease could ignite.

CAUTION Should an oven fire occur, close the oven door and turn off the oven. If the fire continues, throw baking soda on the fire or use fire extinguisher. DO NOT put water or flour on the fire. Flour may be explosive.













Setting Broil

The  or  pad controls the Broil feature. When broiling, heat radiates downward from the oven broiler for even coverage. The Broil feature temperature may be set between 400°F and 550°F (205°C and 288°C).

The broil pan and broil pan insert used together allow dripping grease to drain and be kept away from the high heat of the oven broiler. **DO NOT** use the broil pan without the insert (See previous page). **DO NOT cover the broil pan insert with foil.** The exposed grease could ignite.

⚠ WARNING Should an oven fire occur, leave the oven door closed and turn off the oven. If the fire continues, throw baking soda on the fire or use a fire extinguisher. **DO NOT** put water or flour on the fire. Flour may be explosive and water can cause a grease fire to spread and cause personal injury.

To set the upper oven to broil at 550°F:

1. Place the broiler pan insert on the broiler pan. Then place the food on the broiler pan insert. **DO NOT** use the broiler pan without the insert. **DO NOT** cover the broiler insert with foil. The exposed grease could ignite.
2. Arrange the interior oven rack and place the broiler pan on the rack. Be sure to center the broiler pan directly under the broiler element. **Make sure the oven door is in the broil stop position (See illustration on previous page).**
3. Press  or . (Note: To use the lower oven instead of the upper oven, press  or  at this time.)
4. Press  or . "---" will appear and "UPPER" and "BROIL" will flash in the display (Figure 1).
5. Press , , . "550°" will appear in the display (Figure 2).
6. Press . "UPPER" and "BROIL" will stop flashing and the oven icon will appear in the display. The oven will begin to broil. "550°" will stay in the display (Figure 3).
7. Broil on one side until food is browned; turn and cook on the second side. Season and serve. **Note:** Always pull the rack out to the stop position before turning or removing food.
8. To cancel broiling, press  or .

Note: To change temperature after the oven has begun go back to steps 4 to 6.

Broiler Clean-Up Tips:

To make cleaning easier, line the bottom of the broiler pan with aluminum foil. **DO NOT** cover the broiler pan insert with foil.





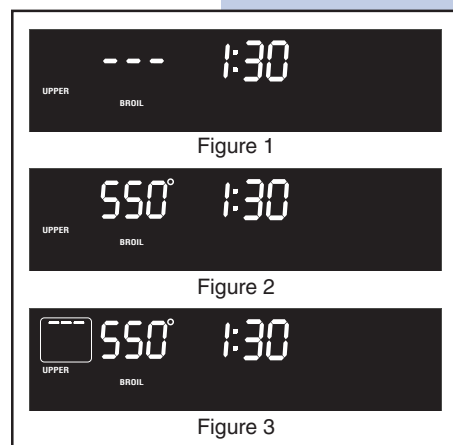

To prevent grease from baking on, remove the broiler pan from the oven as soon as cooking is completed. Use hot pads because the broiler pan is extremely hot. Pour off grease. Soak the pan in **HOT**, soapy water.



Clean the broiler pan as soon as possible after each use. If necessary, use soap-filled steel wool pads. Heavy scouring may scratch the broiler pan insert.













32 Cooking Instructions

SABBATH FEATURE (FOR USE ON THE JEWISH SABBATH & HOLIDAYS)







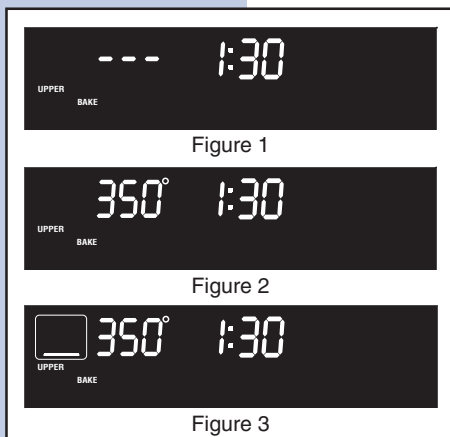



The  or  and  or  pads are used to set the Sabbath feature. The Sabbath feature may only be used with the  or  pad. The oven temperature may be set higher or lower after setting the Sabbath feature (the oven temperature adjustment feature should be used only during Jewish Holidays), however the display will not visibly show or provide any audible tones indicating whether the change occurred correctly. Once the oven is properly set using Bake with the Sabbath feature active, the oven will remain continuously ON until cancelled. This will override the factory preset 12-Hour Energy Saving feature.





If the oven light will be needed during the Sabbath, press  or  before activating the Sabbath feature. Once the oven light is turned ON and the Sabbath feature is active, the oven light will remain ON until the Sabbath feature is turned OFF. If the oven light needs to be OFF, be sure to turn the oven light OFF before activating the Sabbath feature.

IMPORTANT NOTES: It is not advised to attempt to activate any other program feature other than **BAKE** while the Sabbath feature is active. ONLY the following key pads will function after setting the Sabbath feature;  to ,  or ,  or ,  or ,  &  or . **ALL OTHER KEYPADS** will not function once the Sabbath feature is properly activated.



To Program the Upper Oven to Begin Baking Immediately & Activate the Sabbath feature (example: baking at 350°F)

1. Be sure that the clock is set with the correct time of day.
2. Place the food in the oven.
3. Press  or . (Note: To use the lower oven instead of the upper oven, press  or  at this time.)
4. Press  or , "---" will appear, "UPPER" and "BAKE" will flash in the display (Figure 1).
5. Press , , . "350°" will appear, "UPPER" and "BAKE" continue flashing in the display (Figure 2).
6. Press . "UPPER" and "BAKE" stop flashing and the oven icon will appear in the display (Figure 3).

7. If you desire to set the oven control for a **Timed Bake** or **Delayed Timed Bake** do so at this time. If not, skip this step and continue to step 8. Refer to the **Timed Bake** (see page 25, complete steps 7-9) / **Delayed Timed Bake** (see pages 26-27, complete steps 7-12) section for complete instructions. Remember the oven will shut down after using **Timed Bake** or **Delay Timed Bake** and therefore may only be used once during the Sabbath/Jewish Holidays. The maximum **Delayed Timed Bake** time is 11 hours & 59 minutes.
8. The oven will turn ON and begin heating.
9. Press and hold both the  (or ) and  (or ) pads for at least 3 seconds. **SAb** will appear in the display (figure 1). Once **SAb** appears in the display the oven control will no longer beep or display any further changes and the oven is properly set for the Sabbath feature.

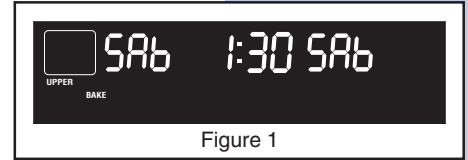





















Figure 1

Note: You may change the oven temperature once baking has started by first selecting the oven you want to change the temperature ( (or ) or  (or ) and then pressing  or , the numeric key pads for the temperature you want (example for 425°C press , , ) and then pressing  TWICE (for Jewish Holidays only). Remember that **the oven control will no longer beep or display any further changes** once the oven is set for the Sabbath feature.

10. The oven may be turned OFF at any time by first pressing  or  pad (this will turn the oven OFF only). To turn OFF the Sabbath feature press and hold both the  (or ) and  (or ) pads for at least 3 seconds. **SAb** will disappear from the display.

Should you experience a power failure or interruption, the oven will shut off. When power is returned the oven will not turn back on automatically. The oven will remember that it is set for the Sabbath and the food may be safely removed from the oven while still in the Sabbath feature, however the oven cannot be turned back on until after the Sabbath. After the Sabbath observance turn OFF the Sabbath feature. Press and hold both the  (or ) and  (or ) pads for at least 3 seconds. **SAb** will disappear from the display and the oven may be used with all normal functions. For further assistance, guidelines for proper usage, and a complete list of models with the Sabbath feature, please visit the web at <http://www.star-k.org>.

34 Care & Cleaning

USING THE SELF-CLEAN FEATURE

Adhere to the Following Cleaning Precautions:

- Allow the oven to cool before cleaning.
- Wear rubber gloves when cleaning any exterior parts of the oven manually.

⚠ CAUTION During the self-cleaning cycle, the outside of the wall oven can become very hot to the touch. **DO NOT** leave a small children unattended near the appliance.

Before cleaning any part of the oven, be sure the oven is turned off or else push CANCEL pad. Wait until the oven is cool.

⚠ CAUTION The health of some birds is extremely sensitive to the fumes given off during the self-clean cycle of any wall oven. Move birds to another well ventilated room.

DO NOT use oven cleaners or oven protective coatings in or around any part of the self-cleaning oven. **DO NOT** clean the oven door gasket. The gasket on the oven door is essential for a good seal. Care should be taken not to rub, damage or move the gasket. **DO NOT** use any cleaning materials on the gasket. Doing so could damage it. **DO NOT** use **aluminum foil** to line the oven bottom. This may affect cooking or foil could melt and damage the oven surface.

A self-cleaning oven cleans itself with high temperatures (well above cooking temperatures) which eliminate soil completely or reduce it to a fine powdered ash you can whisk away with damp cloth.

Preparing the Oven for Self-Cleaning

1. **Remove any excess spillovers** in the oven cavity **before** starting the self-cleaning cycle. To clean, use hot soapy water and a cloth. Large spillovers can cause smoke or a fire when subjected to high temperatures. **DO NOT** allow food spills with a high sugar or acid content (such as tomatoes, sauerkraut, fruit juices or pie filling) to remain on the surface as they may leave a dull spot even after cleaning.
2. Clean any soil from the oven frame and the door liner (see illustration). These areas heat sufficiently during a self-clean to burn soil on. Clean with hot soapy water.
3. **Remove the broiler pan and insert, all utensils and any foil. These items cannot withstand high cleaning temperatures.**
4. Oven racks and oven rack supports must be removed. If they are not removed the self-cleaning cycle can not start and "Remove Racks" will appear in the display indicating that you must remove the racks and racks supports before starting the clean cycle. When the cycle has finished and the door can be opened replace the oven rack supports and oven racks.



STARTING SELF-CLEAN CYCLE

The **Clean** (or **3hr**), **Lite Clean** (or **2hr**) and **Heavy Clean** (or **4hr**) pad controls the Self-Cleaning feature. If you are planning to use the oven immediately after a self-clean cycle remember to allow time for the oven to cool down and the oven door to unlock. This normally takes about one hour. A 3 hours self-clean cycle will actually take about 4 hours to complete.

*It is recommend to use a **Lite Clean** or **2hr** (2 hours) cycle for **light soils**, a **Clean** or **3hr** (3 hours) cycle for **average soils**, and a **Heavy Clean** or **4hr** (4 hours) cycle for **heavy soils** (to assure satisfactory results).

⚠ WARNING During the self-cleaning cycle, the outside of the appliance can become very hot to the touch. **DO NOT** leave small children unattended near the appliance; they may be burned if they touch the hot oven door surfaces.

⚠ CAUTION **DO NOT** force the oven door open. This can damage the automatic door locking system. Use care when opening the oven door after the self-cleaning cycle. Stand to the side of the oven when opening the door to allow hot air or steam to escape. The oven may still be VERY HOT.

To start an immediate upper oven Self-Cleaning cycle or to set a delay start time of 4:30 o'clock and shut off automatically (example provided is a default 3 hour Self-Clean cycle)

1. Be sure the clock is set with the correct time of day, the oven is empty and the oven door is closed.
2. Press **Upper Oven** or **⏻**. (Note: To use the lower oven instead of the upper oven, press **Lower Oven** or **⏻** at this time.)
3. Press **Clean** or **3hr**. "3:00", "CLn" will appear, "UPPER" and "CLEAN" will flash in the display (Figure 1). The control will automatically clean for a 3 hour period (default self-cleaning cycle time). Note: 2 hours of Self-Cleaning time may be chosen by pressing **Lite Clean** (or **2hr**) or 4 hours by pressing the **Heavy Clean** (or **4hr**) at this time.
4. Press **START**. "DOOR" and "LOCKED" will flash; "UPPER" and "CLn" will appear in the display and the clock will return to the time of day (Figure 2).

NOTE: If "REMOVE" and "RACKS" appear in the display (Figure 3). Press **CANCEL** or **CANCEL**, remove the oven racks, the oven rack supports and go back to step 2.

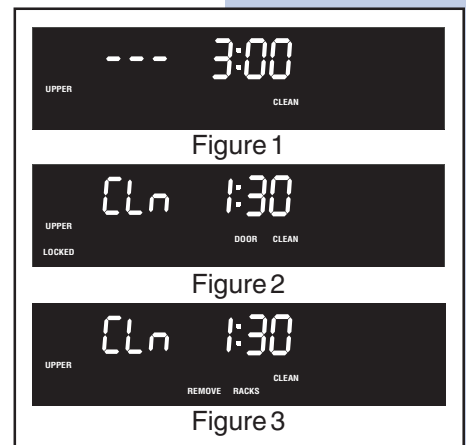

36 Care & Cleaning

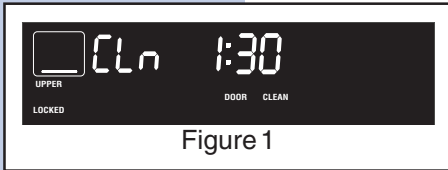

Figure 1

5. As soon as the control is set, the motor driven oven door lock will begin to close automatically. Once the door has been locked the "UPPER", "DOOR" and "LOCKED" indicator light will stop flashing and remain on. Also, the oven icon will appear in the display (Figure 1). Allow about 15 seconds for the oven door lock to close.

Note: If the optional delay Self-Clean feature is needed, finish steps 6-9. If Self-Clean is started immediately skip the remaining steps and continue with "When the Self-Clean cycle is completed".

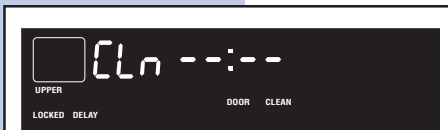



Figure 2

6. Press  or . "UPPER" and "DELAY" will start flashing and "- :-" will appear in the display (Figure 2).

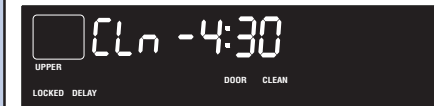





Figure 3

7. Enter the desired start time using the number pads , ,  (Figure 3).

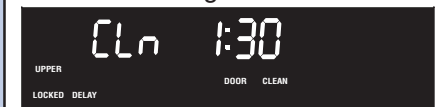



Figure 4

8. Press . The display will return to the time of day (Figure 4).

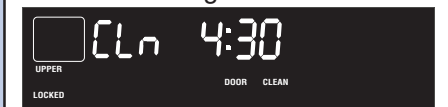

Figure 5



9. The control will start the self-cleaning at the set start time, for the period of time previously selected (Figure 5).

When the Self-Clean Cycle is Completed:

1. Three long beeps will be heard and "CLn" will disappear from the display. "UPPER", "DOOR" and "LOCKED" will remain in the display until the door is unlocked. The cooling fan will continue to run until the oven has cooled down (Figure 6).
2. Once the oven has cooled down for 1 HOUR, and "UPPER", "DOOR" and "LOCKED" are no longer displayed, the oven door can then be opened.

Stopping or Interrupting a Self-Cleaning Cycle:

If it becomes necessary to stop or interrupt a self-cleaning cycle due to excessive smoke in the oven:

1. Press  or .
2. Once the oven has cooled down for approximately 1 HOUR and "UPPER", "DOOR" and "LOCKED" are no longer displayed, the oven door can then be opened.

Important Notes when using the Self-Clean Feature:

1. A Self-Clean cycle cannot be started if **Oven Lockout** feature is active.
2. When Self-Clean cycle is active on one oven, the other one cannot be used or set for a Self-Clean cycle or any cooking.
3. If your clock is set for normal 12 hour display mode the delay Self-Clean cycle can never be set to start more than 12 hours in advance. To set for a delayed Self-Cleaning cycle 12-24 hours in advance see instructions to set the control for the 24 hour time of day display mode.

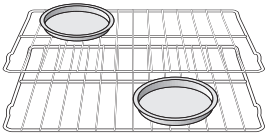

Figure 6

GENERAL CLEANING

Cleaning Various Parts of Your appliance

Before cleaning any part of the appliance, be sure all controls are turned OFF and the appliance is COOL. REMOVE SPILLOVERS AND HEAVY SOILING AS SOON AS POSSIBLE. REGULAR CLEANING WILL REDUCE THE NUMBER OF MAJOR CLEANINGS LATER

Surfaces	How to Clean
Glass, Painted and Plastic Body Parts and Decorative Trim	Using a soft cloth, clean with mild dish detergent and water or a 50/50 solution of vinegar and water. Follow by rinsing the area with clean water; dry and polish with a soft cloth. Glass cleaners may be used if sprayed on a soft cloth first. DO NOT spray liquids directly on the control pad and display area. Do not use large amounts of water on the control panel - excess water on the control area may cause damage to the appliance. Do not use other liquid cleaners, abrasive cleaners, scouring pads, or some paper towels - they will damage the finish.
Control Panel	<i>Before cleaning the control panel</i> , turn all controls to OFF. Glass cleaners may be used if sprayed on a soft cloth first. DO NOT spray liquids directly on the control pad and display area. Wipe with a soft cloth or paper towel. DO NOT use abrasive cleaners or scouring pads. These can permanently damage the control panel surface.
Porcelain Enamel Broiler Pan and Broiler Pan Insert	Gentle scouring with a soapy scouring pad will remove most spots. Rinse with a 1:1 solution of clear water and ammonia. <i>If necessary</i> , cover difficult spots with an ammonia-soaked paper towel for 30 to 40 minutes. Rinse with clean water and a damp cloth, and then scrub with a soap-filled scouring pad. Rinse and wipe dry with a clean cloth. Remove all cleaners or the porcelain may become damaged during future heating.
Stainless Steel, Chrome Decorative Trim, Oven Racks, Oven Racks Support	Clean with hot, soapy water and a dishcloth. Rinse with clean water and a cloth. Cover stubborn spots with an ammonia-soaked paper towel for 30 to 40 minutes. Rinse. Cleaners made especially for stainless steel are recommended. Be sure to rinse the cleaners as bluish stains may occur during heating and cannot be removed.
Oven Racks 	Oven racks and oven rack supports must be removed from the oven during the self-clean cycle for cleaning. If they are not removed, the self-clean cycle will not start. Clean them as described above.
Oven Door	To clean oven door, wash with hot, soapy water and a clean cloth. DO NOT immerse the door in water or clean the oven door gasket.
Oven Gasket	The oven gasket located on the front frame of the oven and visible when the door is opened is essential for a good seal. Care should be taken not to rub, damage or remove the gasket.

38 Care & Cleaning

CARE AND CLEANING OF STAINLESS STEEL

Special care and cleaning are **required** for maintaining the appearance of stainless parts. Please refer to the table provided at the beginning of the **General Care & Cleaning** section in this Use & Care Manual.

TO REMOVE AND REPLACE OVEN DOOR

1. Open the door to the fully opened position.
2. Pull up the lock located on each hinge support toward front of wall oven. You may have to apply a little upward pressure on the lock to pull it up.
3. Grasp the door by the sides, pull the bottom of the door up and toward you to disengage the hinge supports.
Keep pulling the bottom of the door toward you while rotating the top of the door toward the appliance to completely disengage the hinge levers.
4. Proceed in reverse to reinstall the door. Make sure the hinge supports are fully engaged before unlocking the hinge levers.

Removal of the Oven Door

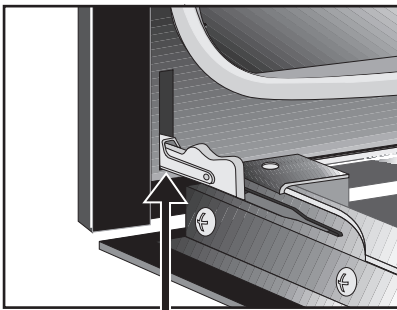

Lock in normal position

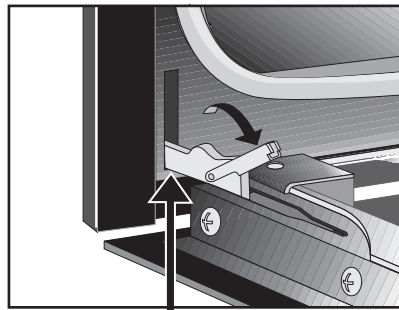

Lock engaged for door removal

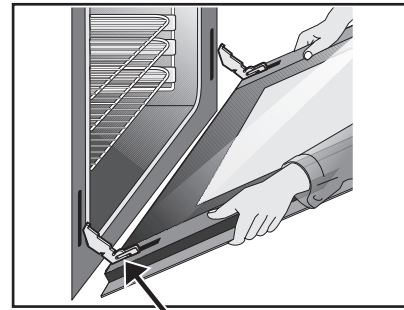

HINGE SLOT
Door removed from the wall oven

SPECIAL DOOR CARE INSTRUCTIONS

Most oven doors contain glass that can break.

Read the following recommendations:

1. Do not close the oven door until all the oven racks are fully in place.
2. Do not hit the glass with pots, pans, or any other object.
3. Scratching, hitting, jarring or stressing the glass may weaken its structure causing an increased risk of breakage at a later time.

TO REMOVE THE "HIDDEN BAKE ELEMENT" COVER

1. In order to remove the "hidden bake" cover, pull the back edge with one hand about 1/2" inch and lift up the "hidden bake" cover with both hands. (See picture)
2. When reinstalling the "hidden bake" cover, be sure to put it all the way to the back of the oven and lay it down on the 2 shoulder screws. Then push the front edge of the cover in its place below the front bracket.



To have easier access to the "hidden bake" cover, first remove the oven door by following the instructions above.

IMPORTANT: Always reinstall the "hidden bake" cover before the next use.

OVEN LIGHT

An interior oven light will turn on automatically when the oven door is opened. The oven light may be turned on when the door is closed by using the oven light switch located on the control panel.

The lamp is covered with a glass shield. The glass shield can be removed to be cleaned manually or to change oven light.

THIS GLASS SHIELD MUST BE IN PLACE WHENEVER THE OVEN IS IN USE.

To replace the light bulb:

CAUTION: BE SURE THE OVEN IS COOL.

1. Turn the power off at the main source.
2. Wear a leather-faced glove for protection against possible broken glass.
3. To remove the glass shield, pull the back side of the shield toward the inside of the oven in a manner to lift it up from the oven side.
4. The glass shield should come out easily by pushing a little toward front of the wall oven.
5. Replace halogen light appliance bulb taking care to not touch the bulb. If you touch the halogen bulb with finger that can damage it and also burn it.
6. To replace glass shield, proceed in reverse.

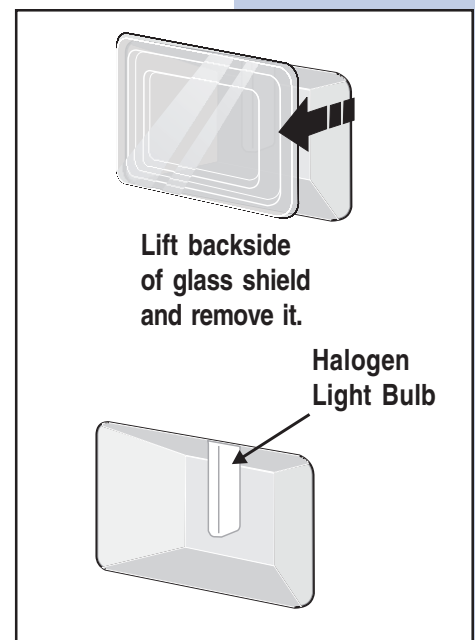

40 Adjusting Oven Temperature

The temperature in the oven has been preset at the factory. When first using the oven, be sure to follow recipe times and temperatures. If you think the oven is too hot or too cool, the temperature in the oven can be adjusted. Before adjusting, test a recipe by using a temperature setting that is higher or lower than the recommended temperature.

The baking results should help you to decide how much of an adjustment is needed.

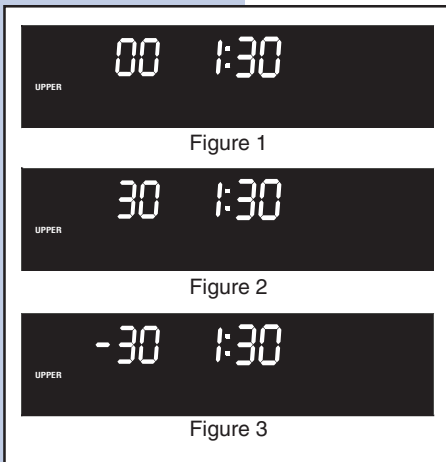

To adjust the upper oven temperature:

1. Press or . (Note: To adjust the lower oven instead of the upper oven, press or at this time.)
2. Press and hold or for 6 seconds. The preset adjustment number will appear and "UPPER" will flash in the display (Figure 1).
3. To increase the temperature use the number pads to enter the desired change. (Example 30°F) (Figure 2). The temperature may be increased as much as 35°F (19°C). To decrease the temperature use the number pads to enter the desired change. (Example -30°F) and then press or (Figure 3). The temperature may be decreased as much as 35°F (19°C).
4. Press to accept the temperature change and the display will return to the time of day. Press or to reject the change if necessary.

IMPORTANT

Before calling for service, review this list. It may save you both time and expense. This list includes common experiences that are not the result of defective workmanship or material in your cooktop.

OVEN CONTROL BEEPS AND DISPLAYS “F” CODE

- Electronic control has detected a fault condition. Push **CANCEL pad** to clear the display and stop the display from beeping. Try to set a cooking function. If a fault reoccurs, record the fault number, push the **CANCEL pad** and contact an authorized servicer.

INSTALLATION

- Place oven rack in center of oven. Place a level on the oven rack. Contact installing agent if rack and cabinet cutout flooring are not level.
- Kitchen cabinet misalignment may make oven appear to be not level. Be sure cabinets are square and level. Contact cabinet maker to correct problem.

ENTIRE OVEN DOES NOT OPERATE

- When the oven is first plugged in, or when the power supply to the oven has been interrupted, the display will flash. The oven cannot be programmed until the clock is set.
- Be sure electrical cord is securely connected into the electrical junction box.
- Cord/plug is not installed and/or connected. Cord is not supplied with oven. Contact your dealer, installing agent or authorized servicer.
- Service wiring not complete. Contact your dealer, installing agent or authorized servicer.
- Power outage. Check house lights to be sure. Call your local electric company.
- Short in cord/plug. Replace cord/plug.

42 Solutions to Common Problems

- Controls are not set properly. See instructions to set the controls.
- House fuse has blown or circuit breaker has tripped immediately following installation.
- House fuse may not be fully engaged. Check fuse and screw or engage circuit breaker securely.

OVEN LIGHT DOES NOT WORK

- Burned-out or loose bulb. Follow the instructions under **Oven Light** to replace or tighten the bulb.

SELF-CLEANING CYCLE DOES NOT WORK

- Make sure the oven door is closed.
- Controls not set properly. Follow steps under “Using the Self-Clean Feature”.

OVEN SMOKES EXCESSIVELY DURING BROILING

- Oven door is closed. Door should be open during broiling.
 - Meat too close to the broiler element. Reposition the rack to provide more clearance between the meat and the broiler. Preheat broil element for quick searing operation.
 - Meat not properly prepared. Remove excess fat from meat. Cut remaining fatty edges to prevent curling, but do not cut into the lean.
 - Broiler pan insert on broiler pan wrong side-up. Grease does not drain into broiler pan. Always place the broiler pan insert on the broiler pan with the ribs up and the slots down to allow grease to drip into the pan.
 - Broiler pan used without broiler pan insert or broiler pan insert cover with aluminum foil. **DO NOT** use the broiler pan without the broiler pan insert or cover the broiler pan insert with aluminum foil.
 - Oven needs to be cleaned. Grease has built up on oven surfaces. Regular cleaning is necessary when broiling frequently. Grease or food spatters cause excessive smoking.
-

SOIL NOT COMPLETELY REMOVED AFTER SELF-CLEANING CYCLE IS COMPLETED

- Failure to clean bottom, front, top of oven, frame of oven or door area outside oven seal. These areas are not in the self-cleaning area, but get hot enough to burn on residue. Clean these areas before the self-cleaning cycle is started. Burned on residue can be cleaned with a stiff nylon brush and water or a nylon scrubber. Be careful not to damage the oven gasket.
- Excessive spillovers in oven. Set the self-clean cycle for longer cleaning time.

POOR BAKING RESULTS

- Many factors affect baking results. See **Baking** for hints, causes and corrections. See **Adjusting Oven Temperature**.

FLAMES INSIDE OVEN OR SMOKE FROM VENT

- Excessive spillovers in oven. This is normal, especially for high oven temperatures, pie spillovers or for large amounts of grease on bottom of oven. Wipe up excessive spillovers.

WALL OVEN WARRANTY

Your wall oven is protected by this warranty

	WARRANTY PERIOD	THROUGH OUR AUTHORIZED SERVICERS, WE WILL:	THE CONSUMER WILL BE RESPONSIBLE FOR:
FULL ONE-YEAR WARRANTY	One year from original purchase date	Pay all costs for repairing or replacing any parts of this appliance which prove to be defective in materials or workmanship.	Costs of service calls that are listed under NORMAL RESPONSIBILITIES OF THE CONSUMER. *
LIMITED WARRANTY (Applicable to the State of Alaska)	Time periods listed above.	All of the provisions of the full warranties above and the exclusions listed below apply.	Costs of the technician's travel to the home and any costs for pick up and delivery of the appliance required because of service.

In the U.S.A., your appliance is warranted by Electrolux Home Products North America, a division of White Consolidated Industries, Inc. We authorize no person to change or add to any of our obligations under this warranty. Our obligations for service and parts under this warranty must be performed by us or an authorized Electrolux Home Products North America servicer. **In Canada**, your appliance is warranted by Electrolux Canada Corp.

*NORMAL RESPONSIBILITIES OF THE CONSUMER

This warranty applies only to products in ordinary household use, and the consumer is responsible for the items listed below:

1. Proper use of the appliance in accordance with instructions provided with the product.
2. Proper installation by an authorized servicer in accordance with instructions provided with the appliance and in accordance with all local plumbing, electrical and/or gas codes.
3. Proper connection to a grounded power supply of sufficient voltage, replacement of blown fuses, repair of loose connections or defects in house wiring.
4. Expenses for making the appliance accessible for servicing, such as removal of trim, cupboards, shelves, etc., which are not a part of the appliance when it was shipped from the factory.
5. Damages to finish after installation.
6. Replacement of light bulbs and/or fluorescent tubes (on models with these features).

EXCLUSIONS

This warranty does not cover the following:

1. CONSEQUENTIAL OR INCIDENTAL DAMAGES SUCH AS PROPERTY DAMAGE AND INCIDENTAL EXPENSES RESULTING FROM ANY BREACH OF THIS WRITTEN OR ANY IMPLIED WARRANTY.

NOTE: Some states do not allow the exclusion or limitation of incidental or consequential damages, so this limitation or exclusion may not apply to you.

2. Service calls which do not involve malfunction or defects in workmanship or material, or for appliances not in ordinary household use. The consumer shall pay for such service calls.
3. Damages caused by services performed by servicers other than Electrolux Home Products North America or its authorized servicers; use of parts other than genuine Electrolux Home Products parts; obtained from persons other than such servicers; or external causes such as abuse, misuse, inadequate power supply or acts of God.
4. Products with original serial numbers that have been removed or altered and cannot be readily determined.

IF YOU NEED SERVICE

Keep your bill of sale, delivery slip, or some other appropriate payment record. The date on the bill establishes the warranty period should service be required. If service is performed, it is in your best interest to obtain and keep all receipts. This written warranty gives you specific legal rights. You may also have other rights that vary from state to state. Service under this warranty must be obtained by contacting Electrolux Home Products:

USA
1•800•944•9044
 Electrolux Home Products
 North America
 P.O. Box 212378
 Augusta, GA 30917

Canada
1•866•294•9911
 Electrolux Home Products
 North America
 802, boul. L'ange-Gardien
 L'Assomption, Québec
 J5W 1T6

This warranty only applies in the 50 states of the U.S.A., Puerto Rico, and Canada. Product features or specifications as described or illustrated are subject to change without notice. All warranties are made by Electrolux Home Products North America, a division of White Consolidated Industries, Inc. **In Canada**, your appliance is warranted by Electrolux Canada Corp.