

# Installation Instructions

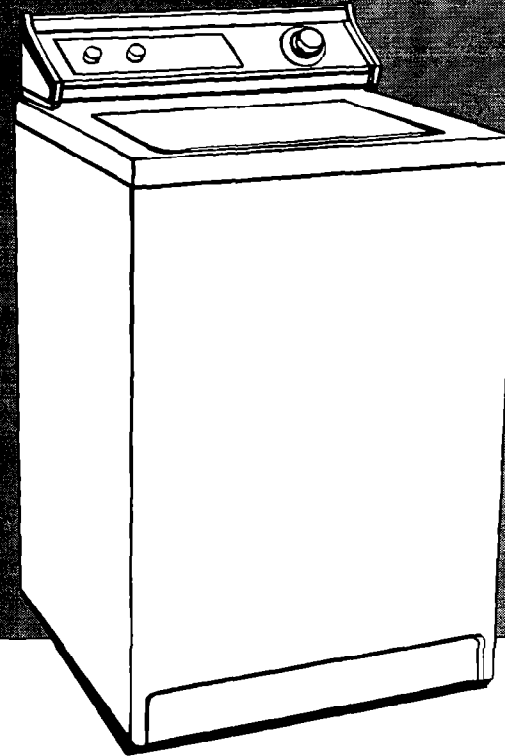

Part No. 3358967 Rev. B

**IMPORTANT:**  
Read and save  
these instructions.

**IMPORTANT:**

**Installer:** Leave Installation Instructions  
with the homeowner.

**Homeowner:** Keep Installation Instructions  
for future reference.

**Save** Installation Instructions for local  
electrical inspector's use.

**Washer**  
**240 volt, 50 Hz**



## Before you start...

Check location where washer will be installed. Proper installation is your responsibility. Make sure you have everything necessary for correct installation.

**Earthed electrical outlet** is required. See Electrical requirements.

**Standpipe drain system:** Needs a two-inch (5.1 centimeters) minimum diameter standpipe with minimum carry-away capacity of 17 gallons (64 liters) per minute. Top of standpipe must be at least 34 inches (86 centimeters) high and no higher than 52 inches (132 centimeters) from bottom of washer.

**Floor drain system** requires a siphon break, Part No. 285320.

Untape and open washer lid. Remove packages and drain hose from washer.

**Hot and cold water faucets:** Must be within 4 feet (122 centimeters) of the back of the washer and provide water pressure 5-100 PSI (34.5-689.6 KPa).

**Laundry tub drain system:** Needs a 20-gallon (76 liter) laundry tub. Top of tub must be at least 34 inches (86 centimeters) high and no higher than 52 inches (132 centimeters) from bottom of washer.

The hot and cold water inlets on the back of the washer have 3/4 — 1 1/2 American hose coupling standard threads.

**Important: Observe all governing codes and ordinances.**

If a longer drain hose is needed, 18" drain hose extension kit (Part No. 285702) is available from Whirlpool authorized parts centres. If drain hose must be shortened, use kit (Part No. 285442).

**Water heater:** Set to deliver 140°F (60°C) water to washer.

**Level floor:** Maximum slope under entire washer — 1 inch (2.5 centimeters).

**Support:** Floor must be sturdy enough to support washer weight of 315 pounds (143 kg).

SEE RECESSED AREA INSTRUCTIONS ON BACK COVER.

## CAUTION

**Product Damage**  
Do Not store or operate washer below 32°F (0°C) (some water may remain in washer).  
See Use & Care Guide for "Winterizing" information.  
Failure to follow above may result in product damage.

## Tools needed for installation:

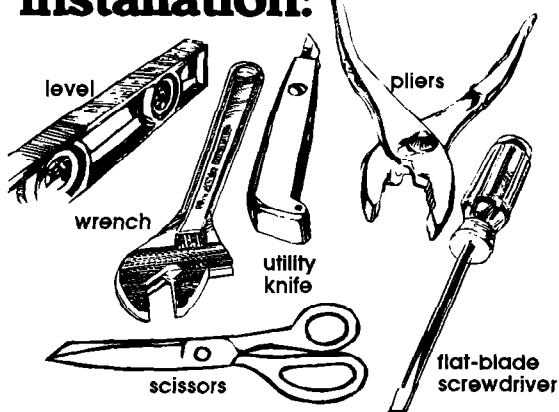

## Parts supplied for installation:

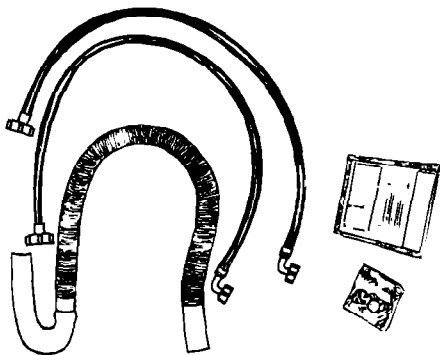

Remove parts from packages. Check that all parts were included.

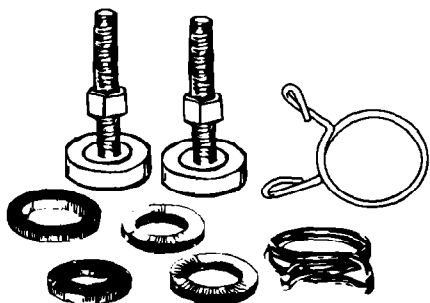

1 small clamp  
literature package  
1 drain hose  
1 hose clamp

4 flat water hose washers  
2 front-leveling legs with nuts  
2 inlet hoses

## Electrical requirements

### WARNING

#### Electrical Shock Hazard

- Electrical earth is required on this appliance.
- Do Not earth to a gas pipe.
- Do Not modify the power supply cord plug. If it does not fit the outlet, have a proper outlet installed by a qualified electrician.
- Do Not have a fuse in the neutral or earthing circuit. A fuse in the neutral or earthing circuit could result in an electrical shock.
- Do Not use an extension cord with this appliance.
- Check with a qualified electrician if you are in doubt as to whether the appliance is properly earthed.

Failure to follow these instructions could result in serious injury or death.

If codes permit and a separate earthing wire is used, it is recommended that a qualified electrician determine that the earthing path is adequate.

Prefix "6" Models.  
240 Volts, 5.0 Amps.  
50 Hz., 8 Amp. fuse.

A fused electrical supply is required. (Time-delay fuse or circuit breaker is recommended.) It is recommended that a separate circuit serving only this appliance be provided.

## Recommended grounding method

For your personal safety, this appliance must be earthed. This appliance is equipped with a power supply cord having a earthing plug.

If the power supply cord of this product is damaged, it must be replaced by a special cord, Part No. 3353308, available from Whirlpool-authorized service centres.

To minimize possible shock hazard, the cord must be plugged into a mating earthing-type wall receptacle, earthed in accordance with local codes and ordinances. If a mating wall receptacle is not available, it is the personal responsibility and obligation of the customer to have a properly earthed wall receptacle installed by a qualified electrician. See Figure 1 to determine the proper mating wall receptacle for the power supply cord plug equipped with this washer.

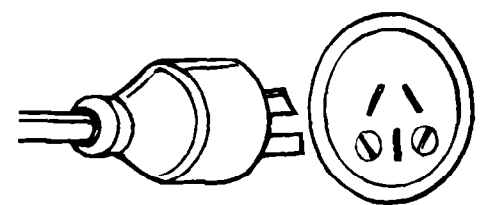
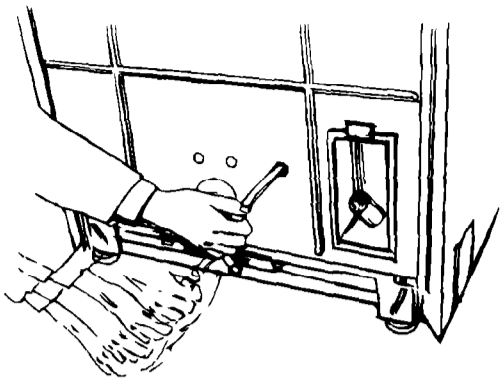

Figure 1

**Now start...**  
With washer in laundry area.



**Pull the strap completely out of the washer.**

**1.**

Remove tape that covers shipping strap. Pull to completely remove the shipping strap with 2 cotterpins from the inside of the washer.

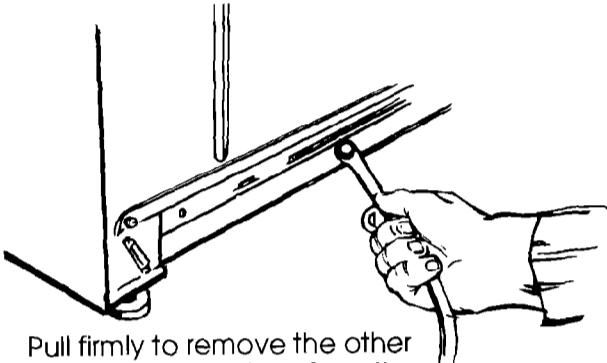

Pull firmly to remove the other end of shipping strap from the back of the washer. The shipping strap plug must be completely removed from the washer for the self-leveling legs to be released.

Save the shipping strap for use in Step 17.

**2.** Read, then remove label that covers drain connector. Peel the tape down and off each side of cabinet.

Use new hoses and washers that came with your washer.



**3.** Insert a flat washer into each end of the inlet hoses. Check that washers are firmly seated in couplings.

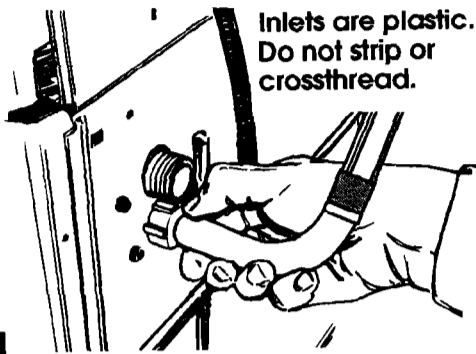

Inlets are plastic. Do not strip or crossthread.

**4.** Attach elbow end of inlet hose to bottom inlet valve opening first; then second hose to top inlet. Tighten couplings by hand.

**IMPORTANT: THIS PROCEDURE MUST BE FOLLOWED TO ASSURE PROPER INSTALLATION.**

**5.** To prevent the drain hose from coming off or leaking, it must be installed per the following instructions:

1. Wet the inside end of the drain hose with tap water. **DO NOT USE ANY OTHER LUBRICANT.**
2. Squeeze ears of clamp with pliers to open and place clamp over the end of the drain hose.

3. While holding clamp open, work end of drain hose onto drain connector until drain hose is within 1/4 inch (0.64 centimeters) of ribbed stop.
4. Position clamp over the drain hose area marked "clamp". Release clamp. Clamp should be 1/4 inch (0.64 centimeters) from end of drain hose.

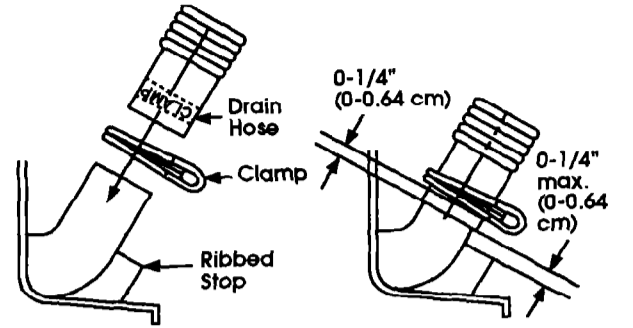

**6.** Open clamp and slide over "hook" end of drain hose to secure the rigid and corrugated sections together.

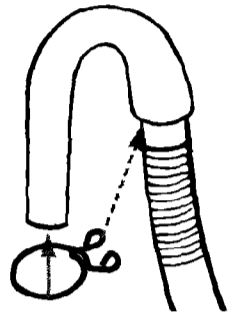

**CAUTION**

Floor Damage

Slide washer onto cardboard or hardboard before moving across floor. Failure to do so may cause damage to floor covering.

**7.** Move washer close to final position. Put "hook" end of drain hose into laundry tub or standpipe. Check for proper length of drain hose.

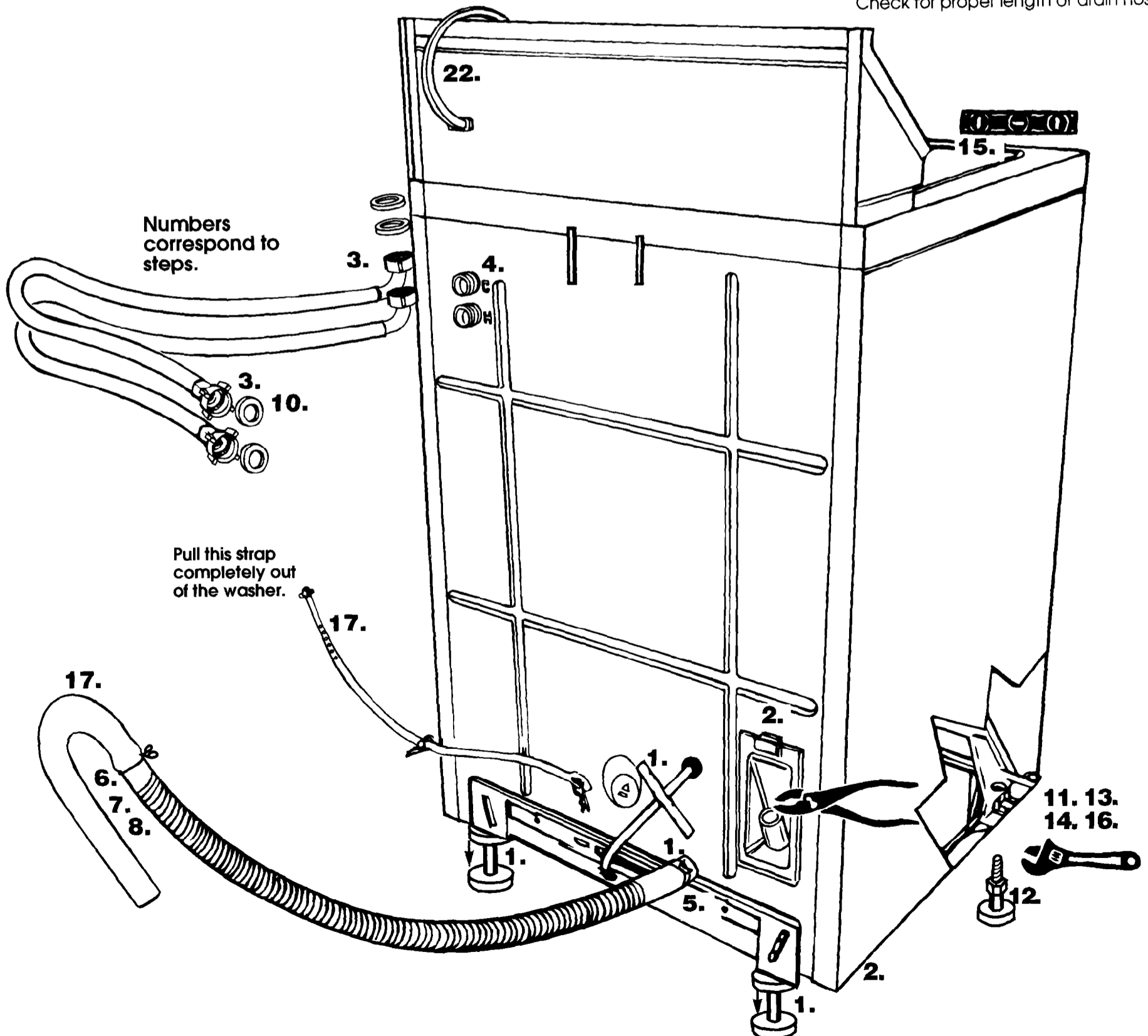

Numbers correspond to steps.

Pull this strap completely out of the washer.

**8.** DO NOT FORCE EXCESS LENGTH OF DRAIN HOSE DOWN THE STANDPIPE. THIS COULD CAUSE SIPHONING.

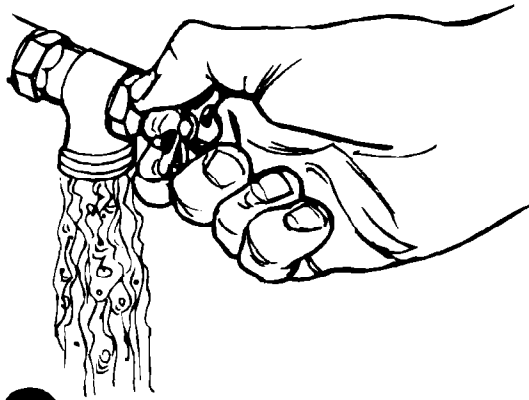

**9.** Before attaching water inlet hose, run water through both faucets into a bucket. This will get rid of particles in the water lines that might clog hoses. Mark which is the hot water faucet.

**10.** Attach bottom hose (inlet marked "H") to hot water faucet. Attach top hose (inlet marked "C") to cold water faucet. An adapter may be necessary to connect the hose to the faucet. Tighten coupling to faucet by hand.

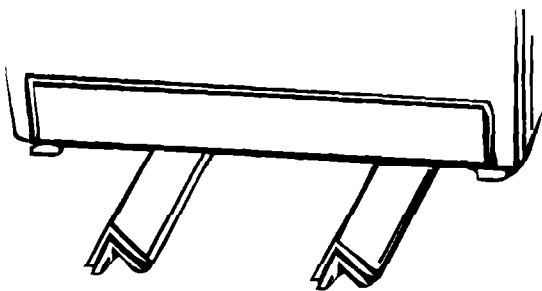

**11.** Stack two corner posts on top of each other. Tilt washer backwards and insert corner posts 3 inches (7.6 centimeters) from one side of washer as shown. Repeat with other corner posts on other side of washer.

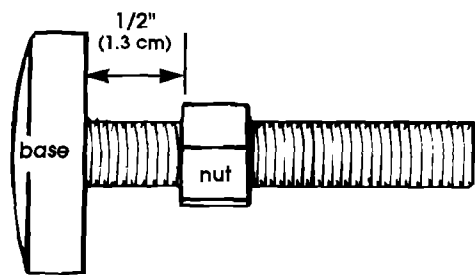

**12.** Use legs and nuts from parts package. Screw nut down to within 1/2 inch (1.3 centimeters) of base.

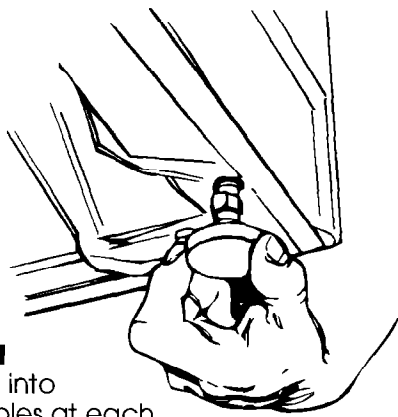

**13.** Insert legs into correct holes at each front corner of washer until nuts touch washer. Do Not tighten nuts until Step 16.

**14.** Tilt washer backward and remove corner posts. Gently lower washer to floor.

**Move washer to its final location. Remove cardboard or hardboard from under washer.**

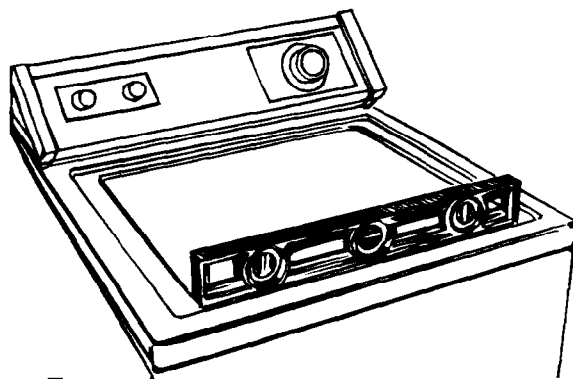

**15.** Tilt washer forward, raising back legs 1 inch (2.54 centimeters) off of floor to adjust rear self-leveling legs. Gently lower washer to floor. Check levelness of the washer by placing a carpenter's level on top of the washer, first side to side; then front to back.

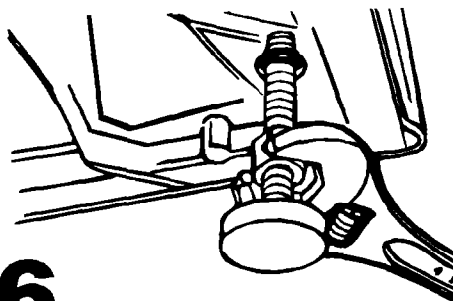

**16.** If washer is not level, adjust the front legs up or down. Repeat Step 15.

**When washer is level, use wrench to turn nuts on front legs up tightly against washer base. If nuts are not tight against washer base, the washer may vibrate.**

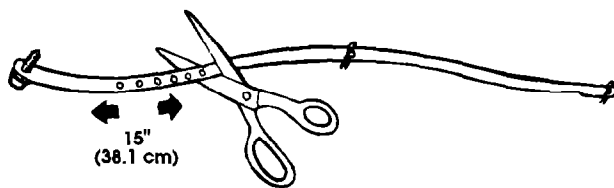
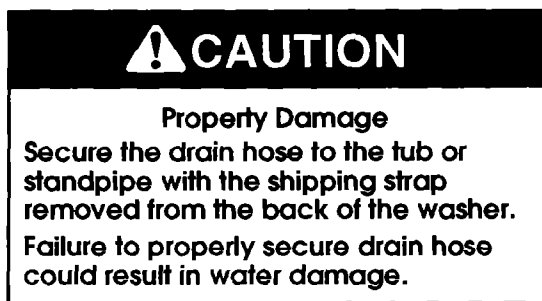

**17.** Measure and mark a point approximately 15 inches (38.1 centimeters) from the plug end of the shipping strap. Cut the shipping strap at this point.

**Check that hose is not twisted or kinked and is securely in place.**

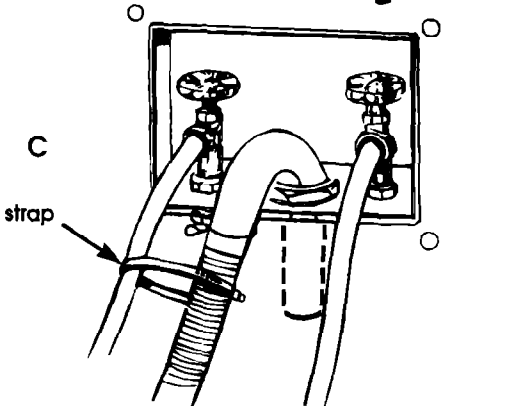
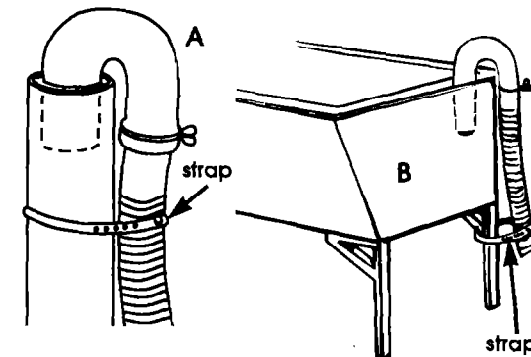

Put "hook" end of drain hose in tub or standpipe. Tightly wrap the shipping strap around the drain hose and tub or standpipe or inlet hose as shown in Figures A-C. Push plug into the nearest hole in the shipping strap.

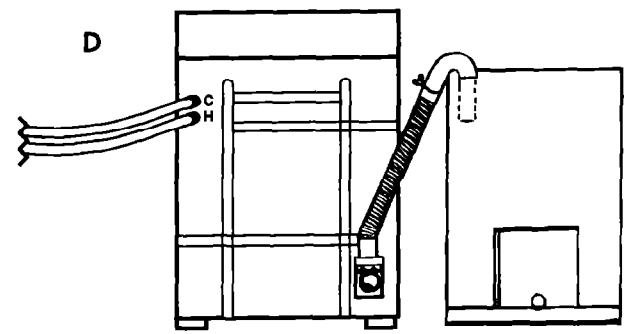

If a longer drain hose is needed, 18" drain hose extension kit (Part No. 285702) is available from authorized parts distributors. If drain hose must be shortened, use hose kit (Part No. 285442).

**Note:** If washer is moved to adjust drain hose, the washer must be leveled again. Repeat Steps 15-16. Place cardboard under the washer and carefully move washer to avoid damaging floor covering.

**18.** CHECK ELECTRICAL REQUIREMENTS. BE SURE YOU HAVE CORRECT ELECTRICAL SUPPLY AND RECOMMENDED GROUNDING METHOD.

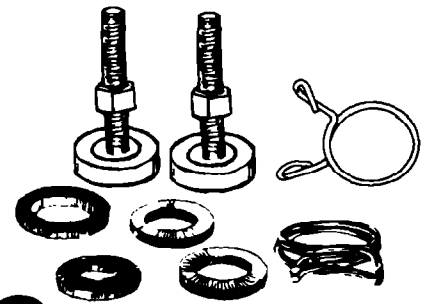

**19.** Check that all parts are now installed. See parts list, Panel A. If there is an extra part, go back through steps to see which step was skipped.

**20.** Turn on water faucets and check for leaks. Tighten couplings if there is leaking. DO NOT OVERTIGHTEN; this could cause damage to faucet.

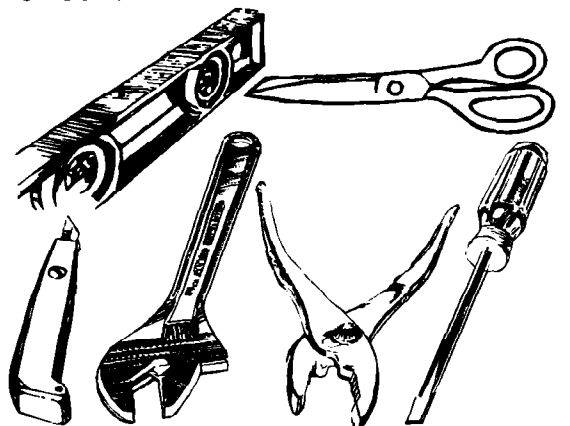

**21.** Check that you have all of your tools. Check that the shipping strap with 2 cotterpins and plug was removed from the back of the washer and used to secure the drain hose.

**22.** Remove power supply cord from basket and plug into earthed outlet.

**23.** Take a few minutes and read the Use and Care Guide to fully understand your new washer. Now start the washer and allow it to complete the regular cycle.



# Recessed area instructions

This washer may be installed in a recessed area or closet.

The installation spacing is in inches and is minimum allowable.

Additional spacing should be considered for ease of installation and servicing.

If closet door is installed, the minimum air openings in top and bottom are required. Louvered doors with air openings in top and bottom are acceptable.

Companion appliance spacing should be considered.

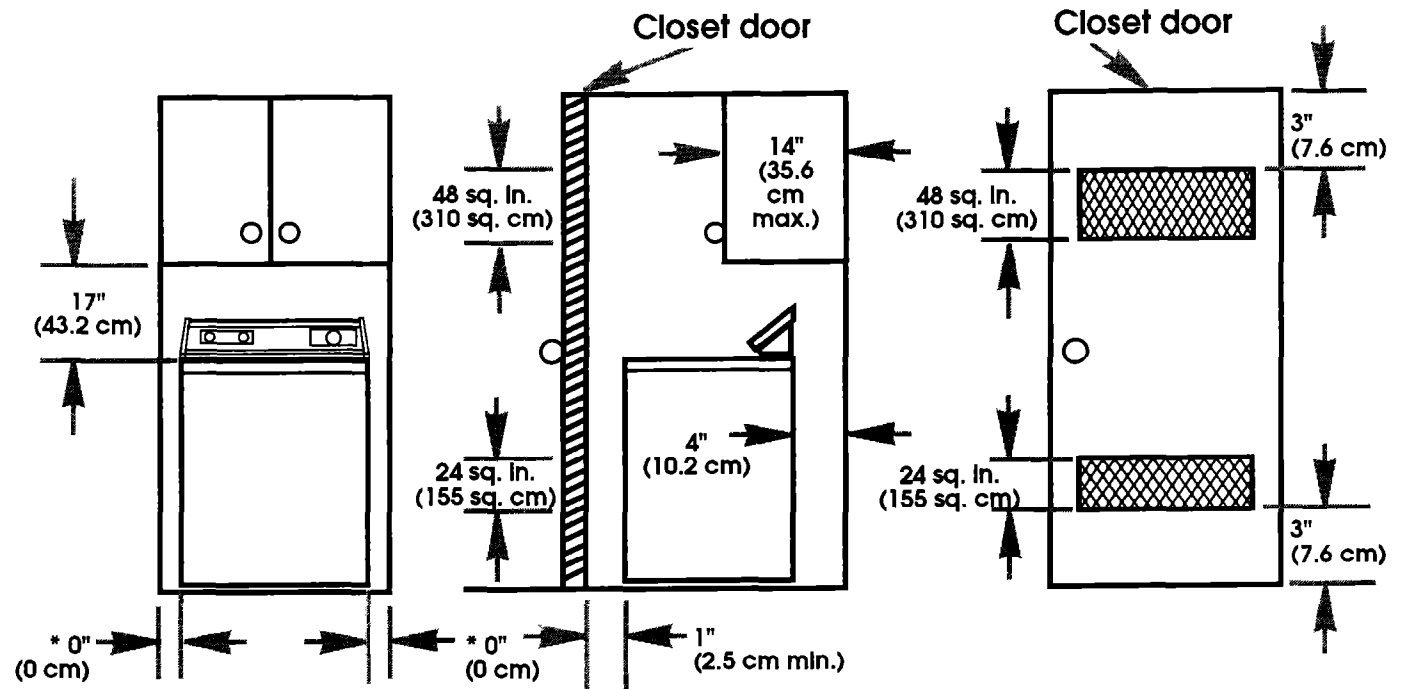

\* Additional clearances for wall, door and floor molding may be required.

Front view  
(door not shown)

Side view

Front view

Minimum installation spacing

## If you need assistance...

Call your dealer or local authorized service company.

When you call, you will need the washer model number and serial number. Both numbers are on the serial/rating plate located under the washer lid and on the top of the washer.



Printed on recycled paper.  
10% post consumer waste/  
50% recovered materials.