

# Installation Instructions

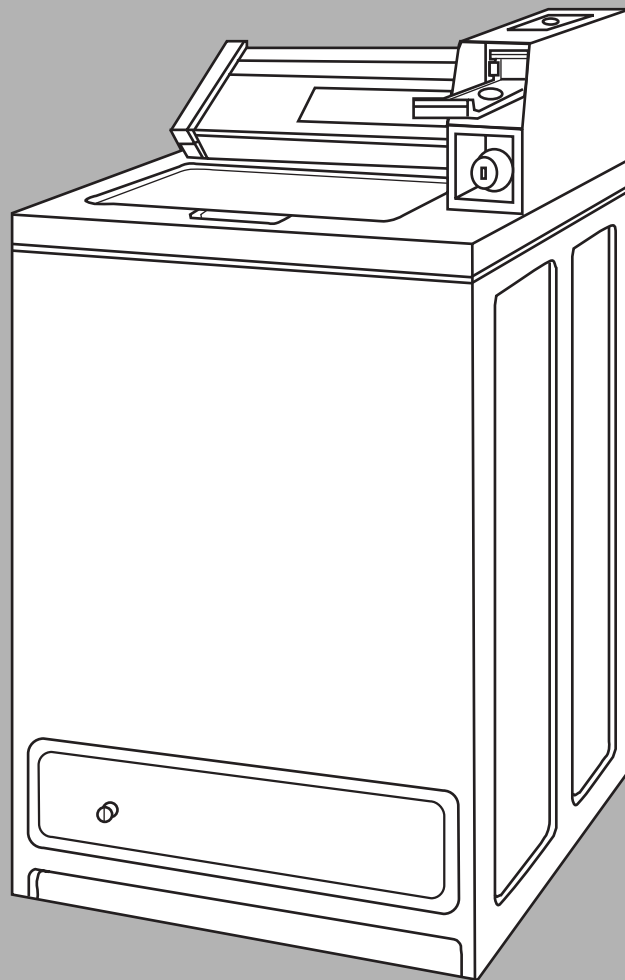

Part No. 3406978

**IMPORTANT:**  
**Read and save**  
**these instructions**

**COMMERCIAL WASHER**

**IMPORTANT:**

**Installer:** Leave Installation Instructions with the owner.

**Owner:** Keep Installation Instructions for future reference.

**Save** Installation Instructions for local electrical inspector's use.

**240-volt, 50-Hz Models**



[www.whirlpool.com](http://www.whirlpool.com)

# Before you start...

**Your safety and the safety of others is very important.**

We have provided many important safety messages in this manual and on your appliance. Always read and obey all safety messages.



This is the safety alert symbol. This symbol alerts you to hazards that can kill or hurt you and others. All safety messages will be preceded by the safety alert symbol and the word "DANGER" or "WARNING". These words mean:

Check location where washer will be installed. Proper installation is your responsibility. Make sure you have everything necessary for correct installation.

## **⚠ DANGER**

**You will be killed or seriously injured if you don't follow instructions.**

## **⚠ WARNING**

**You can be killed or seriously injured if you don't follow instructions.**

**All safety messages will identify the hazard, tell you how to reduce the chance of injury, and tell you what can happen if the instructions are not followed.**

**Do Not store or operate washer below 32°F (0°C)(some water may remain in washer).**

**See Use & Care Guide for "Winterizing" information.**

**Hot and cold water faucets:** Must be within 4 feet (122 cm) of the back of the washer and provide water pressure 10-100 PSI (69-689.6 kPa). A pressure reduction valve should be used in the supply line where inlet pressure exceeds 100 PSI (689.6 kPa) to prevent damage to the washer mixing valve.

Single washer installations require 12-inch (30.5-cm) minimum risers to provide an air cushion and prevent noise and damage to valves.

**Grounded electrical outlet** is required. See Electrical requirements.

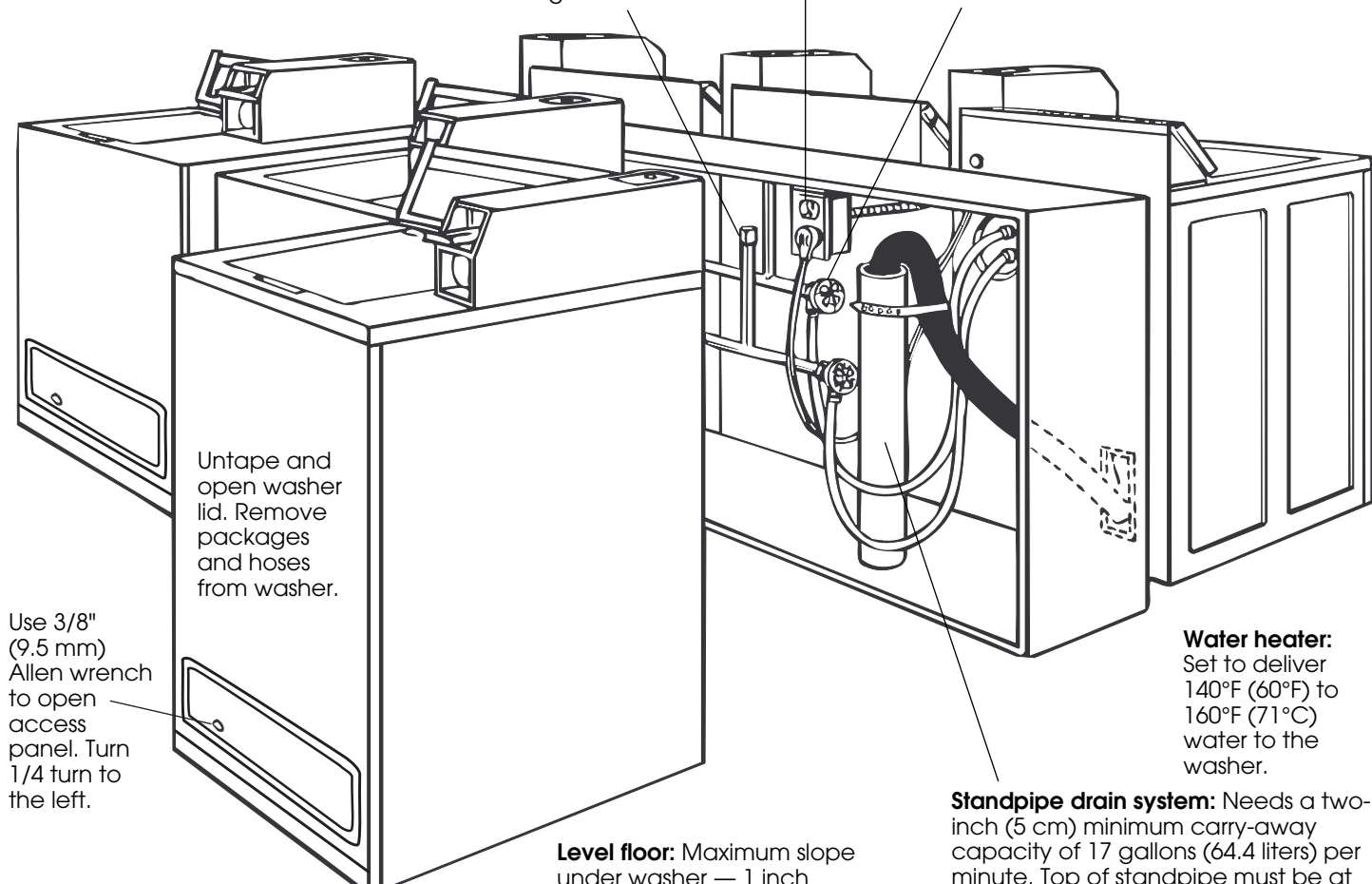

Untape and open washer lid. Remove packages and hoses from washer.

Use 3/8" (9.5 mm) Allen wrench to open access panel. Turn 1/4 turn to the left.

**Level floor:** Maximum slope under washer — 1 inch (2.5 cm)

**Water heater:** Set to deliver 140°F (60°F) to 160°F (71°C) water to the washer.

**Standpipe drain system:** Needs a two-inch (5 cm) minimum carry-away capacity of 17 gallons (64.4 liters) per minute. Top of standpipe must be at least 34 inches (86.4 cm) high and no higher than 72 inches (183 cm) from bottom of washer.

Coin-operated washers are equipped with a meter case, console, timer, selector switches and indicator lights. The coin slide mechanism, slide mounting bolt, slide extension, service door panel lock and key, top lock and key, coin vault, and coin vault lock and key are not included with this washer and are needed to complete installation. These items are available from usual industry sources.

**A floor drain** should be provided under the bulkhead. Prefabricated bulkheads with electrical outlets, water supply lines and drain facilities should be used only where local codes permit.

Non-coin-operated washers are equipped with a console, push-to-start timer, selector switches and indicator lights (not pictured).

**Support:** Floor must be sturdy enough to support loaded washer weight of 315 pounds (143 kg).

**Important: Observe all governing codes and ordinances.**

## Tools needed for installation:

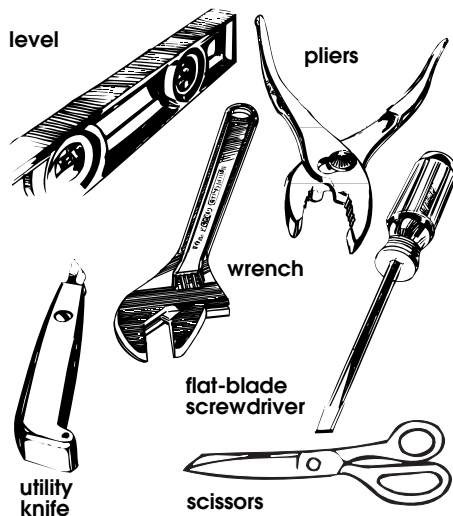

## Parts supplied for installation:

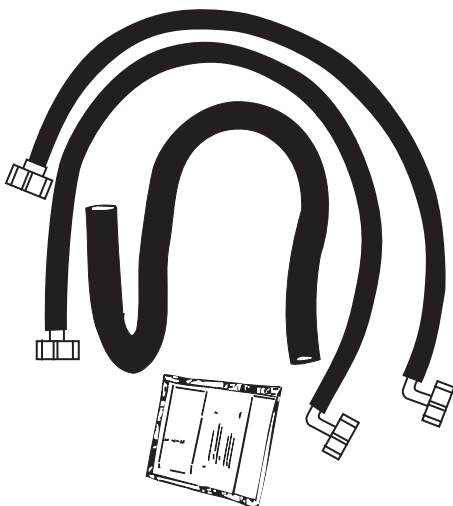

Remove parts from packages. Check that all parts were included.

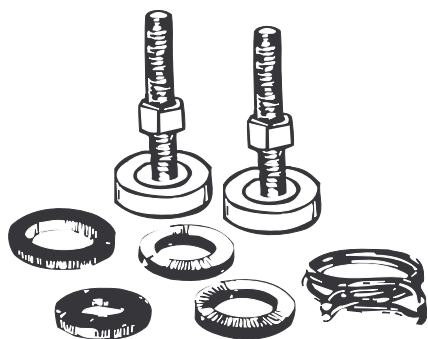

1 hose clamp  
2 inlet hoses  
4 flat water hose washers  
2 front-leveling legs with nuts  
1 drain hose

## Electrical requirements

**⚠ WARNING**

**Electrical Shock Hazard**

**Plug into a grounded 3-prong outlet.**

**Do not remove ground prong.**

**Do not use an adapter.**

**Do not use an extension cord.**

**Failure to follow these instructions can result in death, fire, or electrical shock.**

If codes permit and a separate ground wire is used, it is recommended that a qualified electrician determine that the ground path is adequate.

**Do Not ground to a gas pipe.**

**Check with a qualified electrician if you are not sure the appliance is properly grounded.**

**Do Not have a fuse in the neutral or ground circuit.**

A 240-volt, 50-Hz, AC-only, 4-ampere electrical supply with an 8-ampere fuse is required. (Time-delay fuse or circuit breaker is recommended.) It is recommended that a separate circuit serving only this appliance be provided.

## Recommended ground method

For your personal safety, this appliance must be grounded. This appliance is equipped with a power supply cord having a ground plug. If the supply cord of this product is damaged, it must be replaced by a special cord, Part No. 3353308, available from Whirlpool-authorized service centers.

To minimize possible shock hazard, the cord must be plugged into a mating ground-type outlet, grounded in accordance with local codes and ordinances. If a mating outlet is not available, it is the personal responsibility and obligation of the customer to have a properly grounded outlet installed by a qualified electrician. See Figure 1 to determine the proper mating outlet for the power supply cord plug equipped with this washer.

**WARNING** – Improper connection of the equipment-grounding conductor can result in a risk of electric shock. Check with a qualified electrician or serviceman if you are in doubt as to whether the appliance is properly grounded. Do not modify the plug provided with the appliance – if it will not fit the outlet, have a proper outlet installed by a qualified electrician.

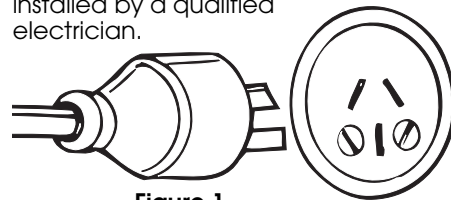

Figure 1

## Now start...

With washer in laundry area.

**⚠ WARNING**

**Excessive Weight Hazard**

**Use two or more people to move and install washer.**

**Failure to do so can result in back or other injury.**

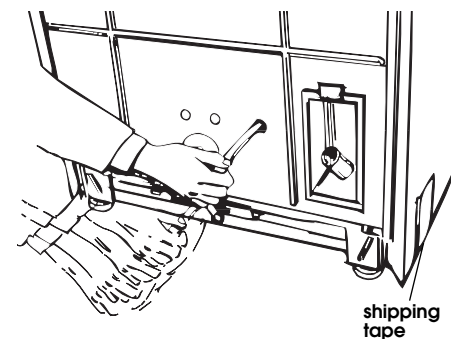

**Pull the strap completely out of the washer.**



**1.** Remove tape that covers shipping strap. Pull to completely remove the shipping strap with 2 cotterpins from the inside of the washer.

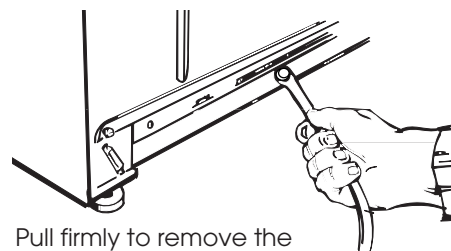

Pull firmly to remove the end of shipping strap from the back of the washer. The shipping strap plug must be completely removed from the washer for the self-leveling legs to be released.

**Save the shipping strap for use in Step 7.**

**2.** Remove the power supply cord from the basket. Peel the tape down and off each side of cabinet.

**Use new hoses and washers that came with your Whirlpool washer.**

Replace inlet hoses after 5 years of use to reduce the risk of hose failure. Inspect and replace inlet hoses if bulges, kinks, cuts, wear, or leaks are found. When replacing your inlet hoses, mark the date of replacement on the label with a permanent marker.

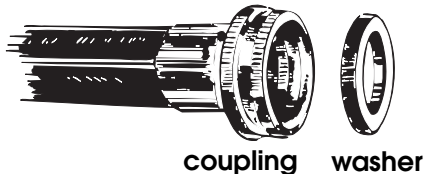

coupling washer

**3.** Insert a flatwasher into **each** end of the inlet hoses. Check that washers are firmly seated in couplings.

**Inlets are plastic. Do Not strip or crossthread.**

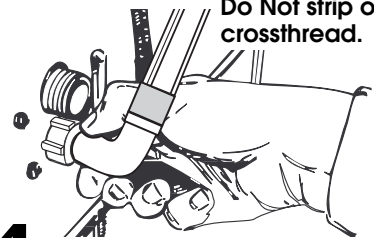

**4.** Attach hose to bottom inlet valve opening first. Then second hose to top inlet. Tighten couplings by hand; then use pliers to make an additional two-thirds turn.

Slide washer onto cardboard or hardboard before moving across floor.

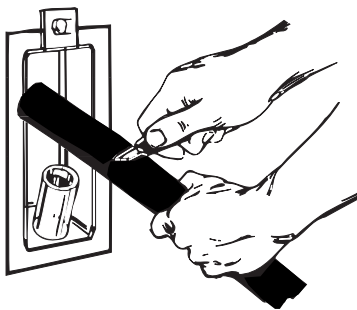

**5.** Move washer close to final position. Put "hook" end of drain hose into standpipe. Estimate length of drain hose needed when washer is in final position. Hose must be cut exactly to length so "hook" end is held tightly over edge of standpipe. If drain hose is too long, cut straight end of hose. **(Do Not cut "hook" shaped end of drain hose.)**

**DO NOT FORCE EXCESS LENGTH OF DRAIN HOSE DOWN THE STANDPIPE. THIS COULD CAUSE SIPHONING. See Step 7.**

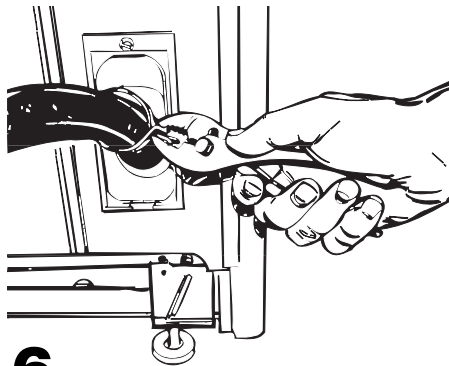

**6.** Place hose clamp over washer drain connector. Push drain hose onto washer connector. Use pliers to open clamp and slide clamp over drain hose. Check for good fit.

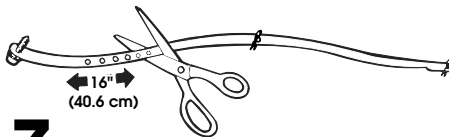

**7.** Measure and mark a point approximately 16 inches (40.6 cm) from the plug end of the shipping strap. Cut this shipping strap at this point.

**Check that hose is not twisted or kinked and is securely in place.**

Put "hook" end of drain hose into standpipe. Tightly wrap the shipping strap around the standpipe. Push plug into the nearest hole in the shipping strap.

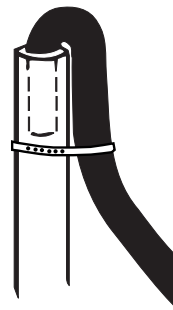

**8.** Before attaching water inlet hoses, run water through both faucets into a bucket.

This will get rid of particles in water lines that might clog hoses. Mark which is the hot water faucet.

Replace inlet hoses after 5 years of use to reduce the risk of hose failure. Inspect and replace inlet hoses if bulges, kinks, cuts, wear, or leaks are found. When replacing your inlet hoses, mark the date of replacement on the label with a permanent marker.

**9.** Attach bottom hose (inlet marked "H") to hot water faucet. Attach top hose (inlet marked "C") to cold water faucet. Tighten coupling to faucet by hand; then use pliers to make final two-thirds turn.

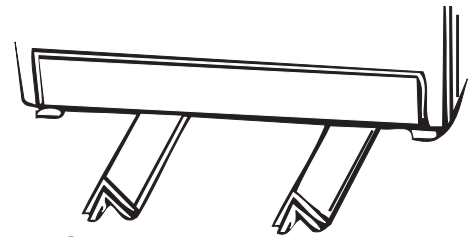

**10.** Stack two corner posts on top of each other. Tilt washer backwards and insert corner posts 3 inches (7.6 cm) in from one side of washer as shown. Repeat with other corner posts on other side of washer.

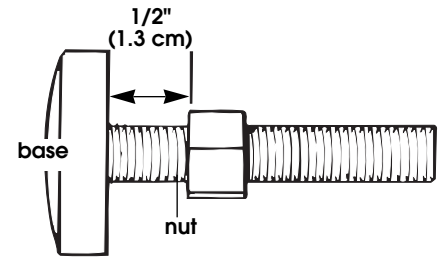

**11.** Use legs and nuts from parts package. Screw nut down to within 1/2 inch (1.3 cm) of base.

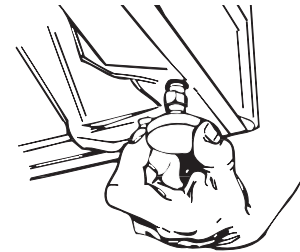

**12.** Insert legs into correct holes at each front corner of washer until nuts touch washer. **Do Not** tighten nuts until Step 15.

**13.** Tilt washer backward and remove corner posts. Gently lower washer to floor.

**Move washer to its permanent location. Remove cardboard or hardboard from under washer.**

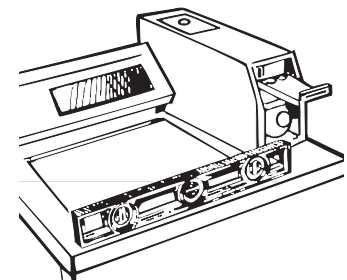

**14.** Tilt washer forward raising back legs 1 inch (2.5 cm) off floor. To adjust rear self-leveling legs, gently lower washer to floor. Check levelness of the washer by placing a carpenter's level on top of the washer, first side to side; then front to back.

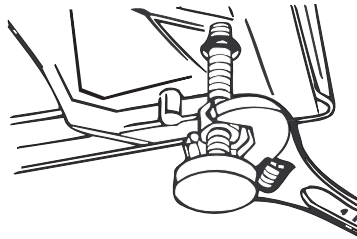

**15.** If washer is not level, adjust the front legs up or down. Make final check with level.

**When washer is level, use wrench to turn nuts on front legs up tightly against washer base. If nuts are not tight against washer base, the washer may vibrate.**

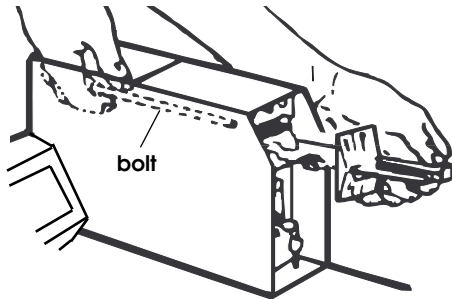

**16.** On coin-operated washers, remove the service door of the meter case. Lift the service door up at the back and remove. Carefully insert coin slide with the coin slide extension attached into front opening and secure with the 3/16" (4.8 mm) mounting bolt from inside the meter case. The coin slide may need to be partially pushed in to insert mechanism in the front opening. Replace meter case top and service door. Insert coin vault with lock and key.

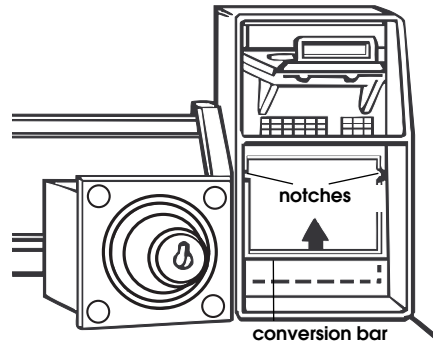

**17.** Put the coin vault with lock and key in the meter case opening. NOTE: A larger-capacity coin vault can be installed. Use a knife to carefully remove the paint along the seam at the bottom of the conversion bar. Use a blade screwdriver and a hammer to lightly tap along the seam area. Raise the conversion bar up to the notches in the sides of the vault opening. Remove the conversion bar and drawer guide. Install new guide (found in parts bag) and the larger coin vault.

**18. CHECK ELECTRICAL REQUIREMENTS. BE SURE YOU HAVE CORRECT ELECTRICAL SUPPLY AND RECOMMENDED GROUNDING METHOD.**

Read yellow label on the back panel. Check off items you have completed. Complete any missed steps before you continue.

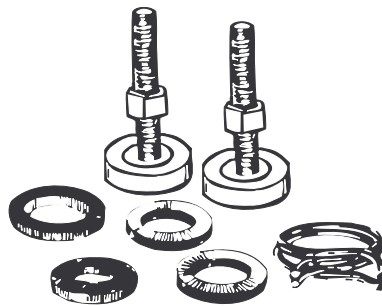

**19.** Check that all parts are now installed. See parts list, Page 3. If there is an extra part, go back through steps to see which step was skipped.

**20.** Turn on water faucets and check for leaks. Tighten couplings if there is leaking. Do Not overtighten; this could cause damage to faucets.



**21.** Check that you have all of your tools. Check that the shipping strap with 2 cotterpins and plug was removed from the back of the washer and used to secure the drain hose.

**If entire strap is not removed, washer may vibrate and be noisy.**

**22.** Remove power supply cord from basket and plug into grounded outlet.

**23.** Check the wash cycle time. The coin-operated washer has a 9-minute wash in the Normal cycle. Remove the meter case top of coin-operated washers to manually start the timer. Start the washer and allow it to complete the Normal cycle.

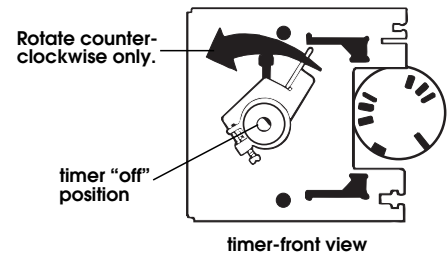

• Coin-operated timers can be started by turning the clutch assembly counterclockwise until the washer starts to fill with water.

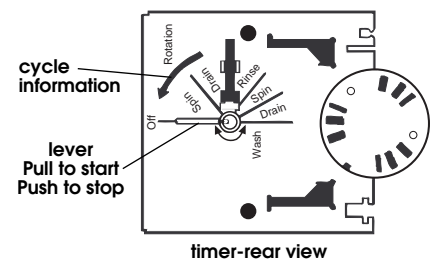

• Non-coin-operated timer cycle information is ink stamped on the rear of the timer. Push in on the lever attached to the timer shaft. Reset lever to the Normal cycle position, then pull out on lever to start washer.

**24.** If the washer fails to start or does not give the proper washer cycle time, the clutch assembly of the coin-operated timer can be adjusted. Remove the timer from the meter case. Adjust the clutch assembly screw clockwise if the washer does not start after the coin slide mechanism has been fully actuated in or out. Adjust the clutch assembly screw counterclockwise if the washer segment of the Normal cycle was less than 9 minutes.

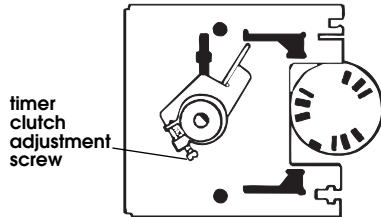

## Typical full load sizes.

Load Type	Loading Suggestion	Load Type	Loading Suggestion
Mixed Load	3 double sheets 4 pillowcases 6 pair shorts 8 T-shirts 2 shirts 2 blouses 8 handkerchiefs	Heavy work clothes	3 pair pants 3 shirts 1 coverall 4 pair jeans 1 overall
Permanent Press	2 double or 1 king size sheet 1 tablecloth 1 dress 1 blouse 2 slacks 3 shirts 2 pillowcases	Knits	3 blouses 4 slacks 6 shirts 4 tops 4 dresses

## Owner options (coin-operated models)

**CAUTION:** Disconnect power cord.

### 1. For EXTRA SPIN and/or EXTRA WASH.

- Remove meter case service door
- Loosen (2) screws on the timer mounting bracket and lift the timer out.

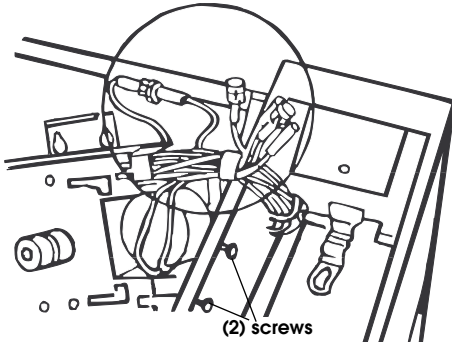

#### a. EXTRA WASH — 3 minutes.

- Connect LBU to LBU2.
- Disconnect GY from GY2.
- Set timer clutch arm as shown below.

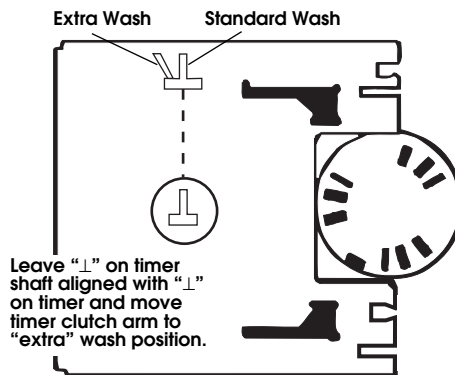

#### b. EXTRA SPIN — 2 minutes.

- Connect BK to BK2

### 2. For WARM RINSE and WATER SAVER:

- Remove screws from each end of the console bottom.
- Pull the console bottom forward; lift and tilt it back.

#### a. WARM RINSE

- Connect J1 to J2

#### b. SAVE WATER

- Pull out tab on water-level switch.

**3.** If use of a larger coin vault, lock and key is desired, conversion bar in lower portion of coin vault area can be removed.

**4.** If additional security is needed, top and cabinet can be locked to washer back panel by using a "screw type" lock and key in space provided in top panel under console. The "screw type" lock and key are available from usual industry sources.

## Check list for washer operation

Check the following if the washer is not operating properly:

1. Power supply cord is plugged in.
2. Circuit breaker is not tripped or fuse blown.
3. Timer has been advanced to start of a cycle.
4. Water faucets are turned on.
5. Inlet and drain hoses are not kinked.
6. Washer lid is closed.
7. Inlet valve is frozen if not protected from the weather.
8. Suds level. Excess suds will slow the spin and cause poor rinsing. Operate the washer through a complete cycle with no detergent. Use less detergent or a controlled suds type detergent in future loads.

## Operating Tips

**! WARNING**



**Fire Hazard**  
**Never place items in the washer that are dampened with gasoline or other flammable fluids.**  
**No washer can completely remove oil.**  
**Do not dry anything that has ever had any type of oil on it (including cooking oils).**  
**Doing so can result in death, explosion, or fire.**

It is recommended that fiberglass items not be washed in coin-operated washers. If these items are washed in the washer, run the washer through a complete cycle to rinse any residue away that might be left in the washer.

## Moving the washer to a new location...

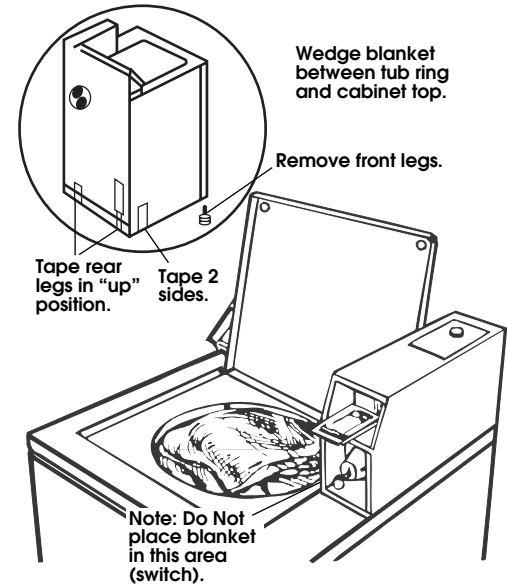

- Remove the front legs from the base of the washer.
- Place both rear leveling legs in the upper position and tape securely.
- Apply tape to the side and bottom of the cabinet near the rear.
- Open washer lid, wedge a blanket between the tub ring and the cabinet top restricting the tub movement.
- Handle washer carefully. **Do Not drop washer while using hand truck.**

