

SERVICE DATA SHEET

318127089 (1007) Rev. A

Electric / Gas / Dual Fuel Slide-In Range with Electronic Oven Control

NOTICE

This service data sheet is intended for use by persons having electrical and mechanical training and a level of knowledge of these subjects generally considered acceptable in the appliance repair trade. **The manufacturer cannot be responsible, nor assume any liability, for injury or damage of any kind arising from the use of this data sheet.**

SAFE SERVICING PRACTICES

To avoid the possibility of personal injury and/or property damage, it is important that safe servicing practices be observed. The following are examples, but without limitation, of such practices.

1. Do not attempt a product repair if you have any doubts as to your ability to complete it in a safe and satisfactory manner.
2. Before servicing or moving an appliance, remove power cord from electric outlet, trip circuit breaker to OFF, or remove fuse and turn off gas supply.
3. Never interfere with the proper installation of any safety device.
4. USE ONLY REPLACEMENT PARTS CATALOGED FOR THIS APPLIANCE. SUBSTITUTIONS MAY DEFEAT COMPLIANCE WITH SAFETY STANDARDS SET FOR HOME APPLIANCES.
5. GROUNDING: The standard color coding for safety ground wires is GREEN OR GREEN WITH YELLOW STRIPES. Ground leads are not to be used as current carrying conductors. IT IS EXTREMELY IMPORTANT THAT THE SERVICE TECHNICIAN REESTABLISH ALL SAFETY GROUNDS PRIOR TO COMPLETION OF SERVICE. FAILURE TO DO SO WILL CREATE A POTENTIAL HAZARD.
6. Prior to returning the product to service, ensure that:
 - All electric connections are correct and secure.
 - All electrical leads are properly dressed and secured away from sharp edges, high-temperature components, and moving parts.
 - All non-insulated electrical terminals, connectors, heaters, etc. are adequately spaced away from all metal parts and panels.
 - All safety grounds (both internal and external) are correctly and securely reassembled.
 - All panels are properly and securely reassembled.

ELECTRONIC OVEN CONTROL (ELECTRIC AND DUAL FUEL RANGES)

1. This self-cleaning controller offers Bake, Broil, Convection Bake, Convection Roasting and Convection Broil modes, Dehydrating, Bread Proof, Keep Warm and Cleaning functions.
2. Convection operates with an element and a fan dedicated to convection.
3. This controller includes a display board, a relay board, and a convection fan and oven light control board.

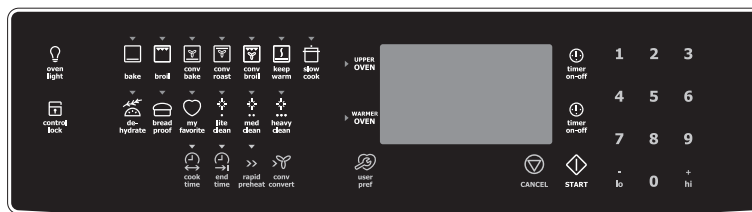
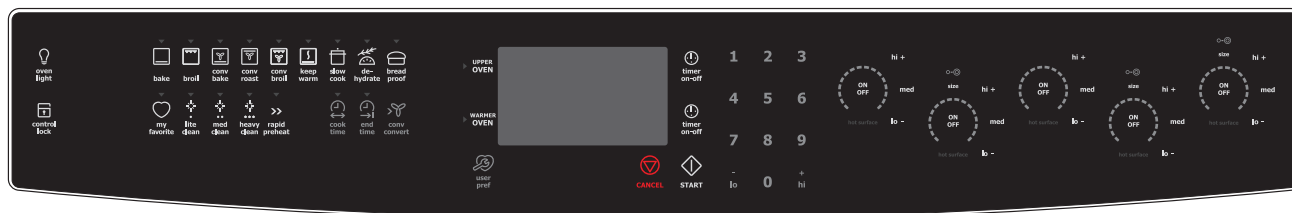

NOTE: The controllers are not field repairable. Only temperature settings can be changed. See oven calibration.

Printed in the United States

ELECTRONIC OVEN CONTROL (GAS RANGES)

1. This self-cleaning controller offers Bake, Broil, Convection Bake and Convection Roasting, Dehydrating, Bread Proof, Keep Warm and Cleaning functions.
2. Convection operates with an element and a fan dedicated to convection.
3. This controller includes a display board, a relay board, and a convection fan and oven light control board.



NOTE: The controllers are not field repairable. Only temperature settings can be changed. See oven calibration.

ELECTRONIC OVEN CONTROL RELAY BOARD FOR ELECTRIC AND DUAL FUEL RANGES

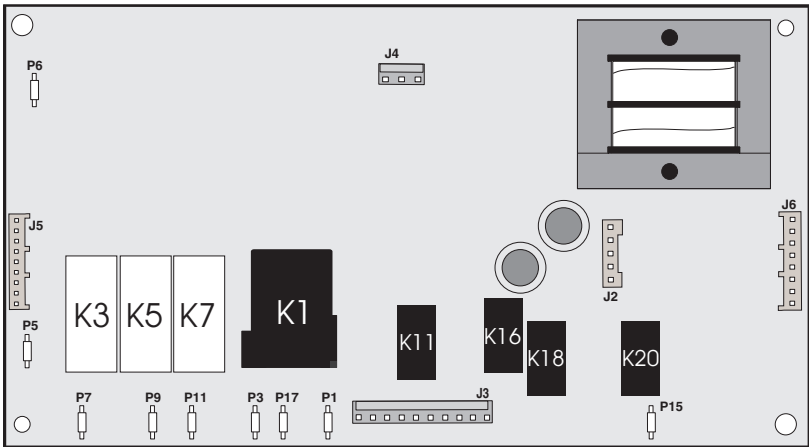

- Relay Board Legend:**
- K1. Double Line Break
 - K3. Broil Relay
 - K5. Bake Relay
 - K7. Convection Element Relay
 - K11. Motor Door Latch Relay
 - K16. Cooling Fan Relay 1
 - K18. Cooling Fan Relay 2
 - K20. Warmer Drawer Element Relay

This relay board serves to energize the upper and lower oven heating elements, door lock motor and cooling fan.

- | | |
|--------------------------------------|---|
| P1- L2 Out | J2- DC Power Output To Display Board |
| P3- L2 In | J3- AC Power Output (motor door latch, cooling fan, warmer drawer element) |
| P5- L1 | J4- Power Input (L1, Neutral) |
| P6- L1 | J5- Relay Control Inputs (bake, broil and convection elements, motor door latch, DLB) |
| P7- Broil | J6- Relay Control Inputs (cooling fan, warmer drawer element) |
| P9- Bake | |
| P11- Convection Element | |
| P15- L1 in for Warmer Drawer Element | |
| P17- Not Used | |

ELECTRONIC SURFACE ELEMENT CONTROL (ESEC) - ELECTRIC MODEL ONLY

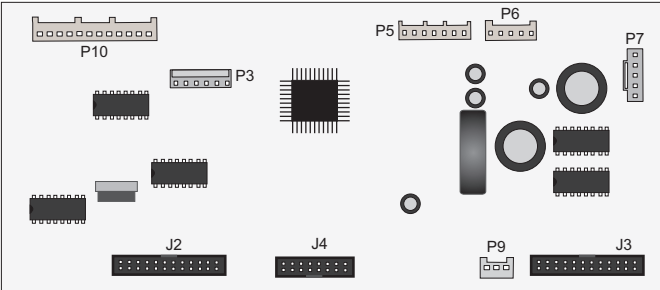

User Interface Board (UIB)

User Interface Board (UIB) Legend:

- J2. Connector for Touch Panel LEDs and Display Indicators
- J3. Connector for Touch Panel LEDs and Display Indicators
- J4. Connector for Keyboard (Touch Panel)
- P3. Micro Programming Header (Not Used)
- P5. Connector for the hot element indicators from Relay Board
- P6. Power Supply Input (from relay board)
- P7. Power Supply Input (from power supply board)
- P9. Communication with Oven Control
- P10. Surface Elements Relay Controls

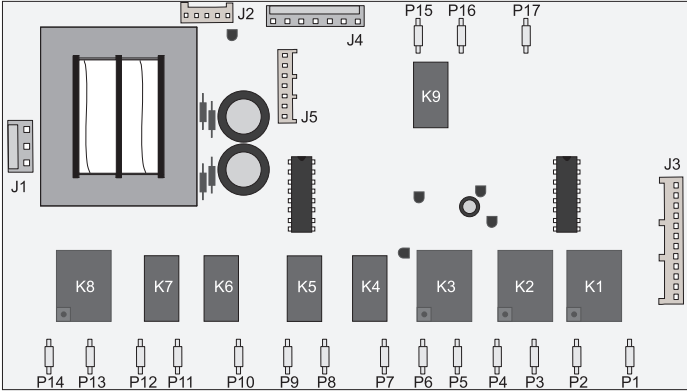

ESEC Relay Board

ESEC Relay Board Legend:

- P1. Right Front Inner Element Connection
- P2. Line In (120V AC)
- P3. Line In (120V AC)
- P4. Right Front Outer Element Connection
- P5. Left Front Inner Element Connection
- P6. Line In (120V AC)
- P7. Left Front Outer Element Connection
- P8. Line In (120V AC)
- P9. Not used
- P10. Right Rear Inner Element Connection
- P11. Line In (120V AC)
- P12. Right Rear Outer Element Connection
- P13. Line In (120V AC)
- P14. Left Rear Element Connection
- P15. Center Rear Element Connection
- P16. Line In (120V AC)
- P17. Not Used

- K1. Right Front Inner Element Relay
- K2. Right Front Outer Element Relay
- K3. Left Front Inner Element Relay
- K4. Left Front Outer Element Relay
- K5. Not used
- K6. Right Rear Inner Element Relay
- K7. Right Rear Outer Element Relay
- K8. Left Rear Element Relay
- K9. Center Rear Element Relay

- J1. Line Voltage Input (120V, Neutral)
- J2. Low Voltage Supply Output For UIB
- J3. Surface Element Relay Control Inputs
- J4. Surface Element Hot Signal Inputs
- J5. Hot Element Signals to UIB

ELECTRONIC CONTROL DISPLAY BOARD FOR ELECTRIC AND DUAL FUEL RANGES

Electronic oven display board for electric ranges

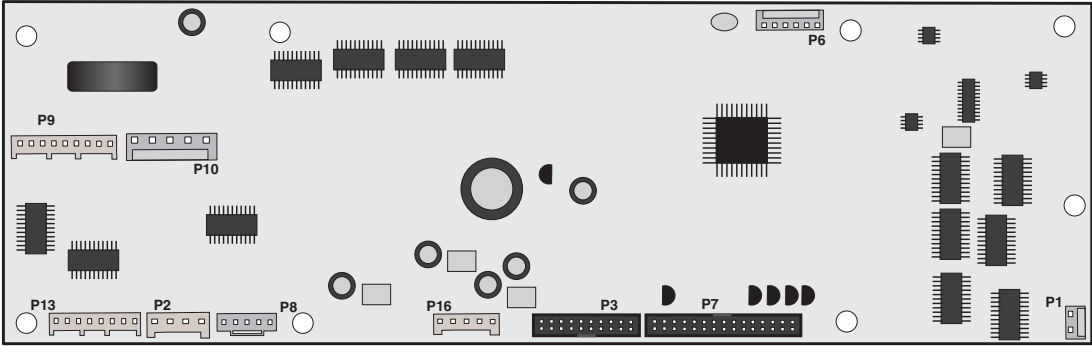

Electronic oven display board for dual fuel ranges

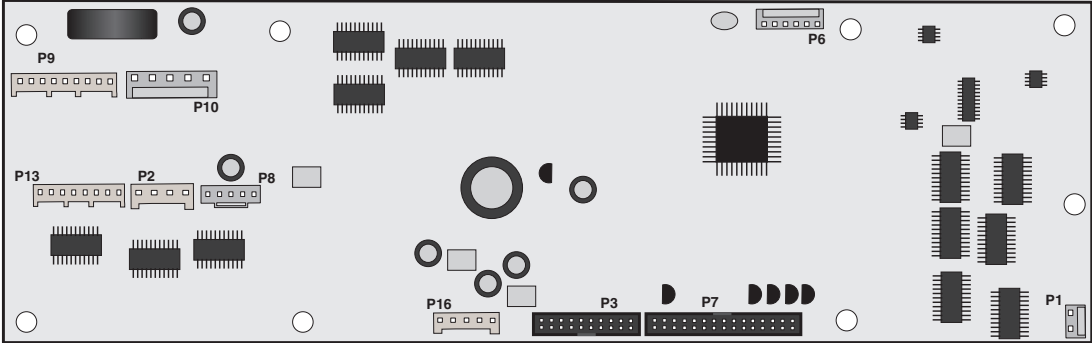

Connector Legend:

- P1 - Upper Oven Probe Input
- P2 - Communication with Convection Fan and Oven Light Control Board, Communication with ESEC30 UIB (electric only)
- P3 - Keyboard (touch panel)
- P6 - Microprocessor Programming (not used)
- P7 - Touch Panel LEDs
- P8 - Power Supply Input
- P9 - Relay Control Output (heating elements, DLB, motor door latch)
- P10 - Switches Input (motor door latch switch, door switch, rack switch)
- P13 - Relay Control Output (cooling fan & warmer drawer element)
- P16 - DC Power Supply Input

POWER SUPPLY BOARD

This board provides power to the oven control display.

- P1 - AC Power Input (L2 and Neutral)
- P2 - DC Power Output

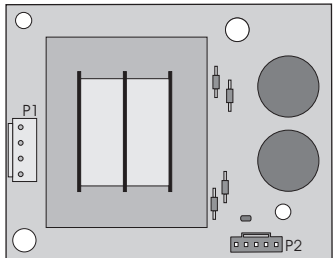

CONVECTION FAN AND OVEN LIGHTS CONTROL BOARD

This board control the power output of the convection fan and oven lights.

- P1 - Communication with display board and power supply input
- P2 - AC power output for convection fan and oven lights, power inputs (L1, neutral)
- P6 - Microprocessor programming (not used)

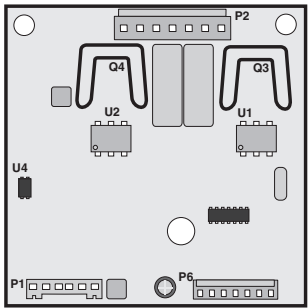

ELECTRONIC OVEN CONTROL RELAY BOARD FOR GAS RANGES

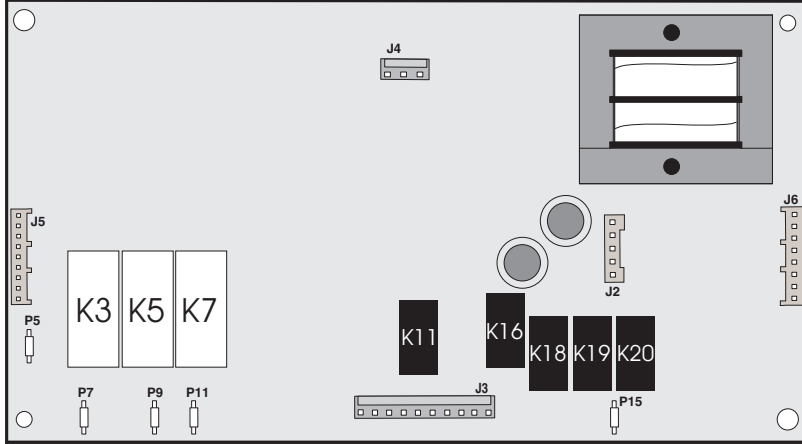

Relay Board Legend:

- K3. Broil Relay
- K5. Bake Relay
- K7. Convection Element Relay
- K11. Motor Door Latch
- K16. Cooling Fan Relay 1
- K18. Cooling Fan Relay 2
- K19. Convection Element Relay
- K20. Warmer Drawer Element Relay

This relay board serves to energize the oven heating elements, door lock motor and cooling fan.

- | | |
|--------------------------|---|
| P5 - L1 | J2 - DC Power Output To Display Control Board |
| P7 - Broil | J3 - AC Power Output (motor door latch, cooling fan, convection element, warmer drawer element) |
| P9 - Bake | J4 - Power Input (L1, Neutral) |
| P11 - Convection Element | J5 - Relay Control Inputs (bake and broil burners, motor door latch, DLB) |
| P15 - L1 | J6 - Relay Control Inputs (cooling fan, conv element, warmer drawer element) |

ELECTRONIC OVEN CONTROL DISPLAY BOARD FOR GAS RANGES

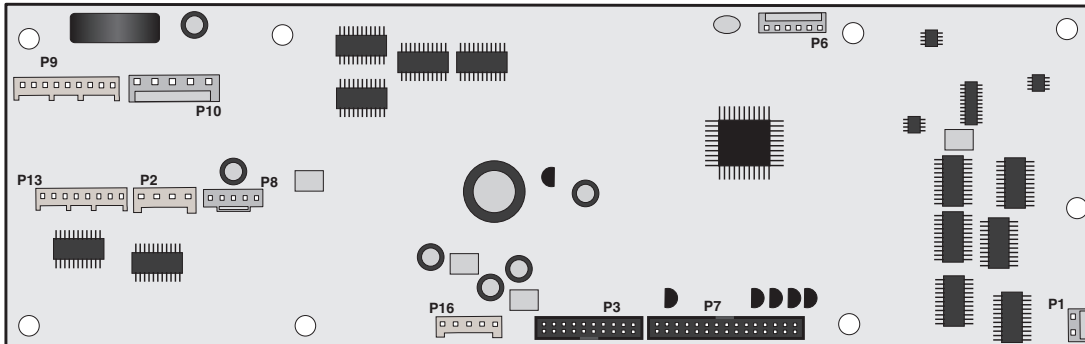

Connector Legend:

- P1 - Oven Probe Input
- P2 - Communication with Convection Fan and Oven Light Control Board
- P3 - Keyboard (touch panel)
- P6 - Microprocessor Programming (not used)
- P7 - Touch Panel LEDs
- P8 - Power Supply Input for Display LEDs
- P9 - Relay Control Output (bake and broil burners, DLB, motor door latch)
- P10 - Switches Input (motor door latch switch, door switch, rack switch)
- P13 - Relay Control Output (cooling fans, convection element, warmer drawer element)
- P16 - DC Power Supply Input

CONVECTION FAN MOTOR

The 120V fan motor is located on the outside of the rear of the oven.

The fan motor runs continuously while in convection mode unless the door is opened.

It is normal to see the fan speed changing depending on the cooking function that is used. This appliance uses the optimum fan speed for each convection function.

It is the Convection Fan and Oven Lights Control Board that modulates the speed of the convection fan. It uses the fan speed information communicated by the display board.

If the fan does not operate, check the following:

- The oven control display will give you an indication on when the convection fan should be on: rotating fan blades in the display means the fan should be ON. No rotating blades mean the convection fan is purposely not used.
- Verify proper operation of the door switch. If the control thinks the door is opened the convection fan will not work. If the oven light turns on when the door is opened and turn off when the door is closed then it's a good indication the door switch is good.
- If you are getting an F23 error code it means the display board is not able to communicate with the Convection Fan and Oven Lights Control Board, thus the convection fan will not operate. Check connections between the display board and the Convection Fan and Oven Lights Control Board. Refer to the fault code section for corrective actions.
- Check connections on the Convection Fan and Oven Lights Control Board. On connector P2: pin 3 should be Neutral, pin 5 should be L1 (120VAC) and pin 7 should go to the convection fan motor. The other terminal of the convection fan motor should be connected to Neutral.
- Fan motor coil resistance should be 15.0 ohm +/- 10%
- When the fan is ON you should see between 20 and 120VAC on the motor, depending on the fan speed.
- If there is no error code, the wiring is good and the fan coil is good then replace the Convection Fan and Oven Lights Control Board.

OVEN CALIBRATION

Set the electronic oven control for normal baking at 350°F. Obtain an average oven temperature after a minimum of 5 cycles. The oven calibration can be modified using the oven control display. Please refer to the Owner's Guide manual.

Note: Changing calibration affects all the cooking modes but not the clean and the broil modes.

FIRST RISE

It is normal to see a temperature overshoot in the first rise of all modes when you monitor the temperature.

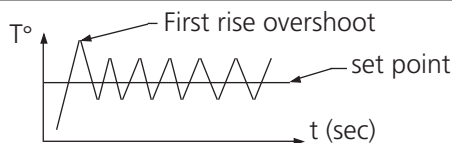

COOLING FAN MOTOR

The 120 volt fan motor is located at the top of the oven cavity. The cooling fan has 1 speed only. The oven control uses 2 relays but their outputs are tied together. Relay 2 is only active during clean cycle at the high temperature and during broil /convection broil cycles. Relay 1 is activated during all other functions. The fan should be active anytime the oven is used and will remain active for some time after a function is cancelled. On the electric range, the cooling fan will also be activated when the cooktop is used.

ELECTRONIC SURFACE ELEMENT CONTROL (ESEC- some models) FAULT CODE DESCRIPTIONS

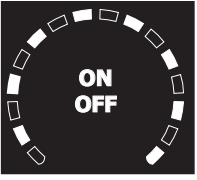
<p>ESEC Errors</p> <p>To indicate an error to the ESEC controls, the display will flash one LED on two and emit audible alarm.</p> 	<p>Shorted Keypad. Disconnect power, wait 30 seconds and reapply power. If fault returns upon power-up: 1. Replace UIB. 2. Replace Glass Touch Panel</p>
	<p>Bad EEPROM. Replace UIB (User Interface Board).</p>
	<p>TST/Display tail missing. Check connection between UIB (connector J2, J3 & J4) & glass touch panel. If connections are good, replace UIB. If problem persists, replace touch panel.</p>
	<p>ESEC self test failed, or thermal cutoff open. 1) If the ESEC controller displays an error code and the oven controller displays an F15 error code at the same time, this is a strong indication that the safety thermostat (thermal cutoff) inside the front console opened. The primary reason for a safety thermostat to open is a deficiency of the cooling fan. With a ohmmeter, verify if the thermostat tripped. Reset the thermostat is needed and verify operation of the cooling fan. 2) An error code on the ESEC may indicate the User Interface Board is not receiving a synchronization signal from the ESEC relay board. Check first if the ESEC relay board is receiving 120VAC correctly (J1 pin 1 and 3). Then check the wiring between connector J2 on the ESEC relay board and connector P6 on the UIB. If AC power and wiring looks good and the problem is still there, replace the UIB board. If problem persists, replace the ESEC relay board.</p>

ELECTRONIC OVEN CONTROL FAULT CODES DESCRIPTIONS

Note: Generally speaking "F1X" implies a control failure, "F3X" an oven probe problem, and "F9X" a latch motor problem.

F10 Control has sensed a potential runaway oven condition. Control may have shorted relay, RTD sensor probe may have a gone bad. 1) Check RTD sensor probe and replace if necessary. If oven is overheating, disconnect power. If oven continues to overheat when power is reapplied, replace relay board and/or display board.

F11 Shorted Key: a key has been detected as pressed for a long period and will be considered a shorted key alarm and will terminate all oven activity. 1) Press any key to clear the error. **2)** If fault returns, replace the keyboard (touch panel). **3)** If the problem persists, replace the display board.

F13 Control's internal checksum may have become corrupted. 1) Press any key to clear the error. **2)** Disconnect power, wait 30 seconds and reapply power. If fault returns upon power-up, replace display board.

F14 Misconnected keyboard cable. 1) Verify connection between display board and touch panel (2 ribbon cables). Make sure the cables are well connected at both ends. **2)** If the cables are good, replace the touch panel. **3)** If the problem persists, replace the display board.

F15 Controller self check failed or terminal cutoff open. 1) Slide-in electric: If the oven controller displays an F15 error code and the ESEC controller displays an E15 error code at the same time, this is a strong indication that the safety thermostat (thermal cutoff) opened. The primary reason for a safety thermostat to open is a deficiency of the cooling fan. With a ohmmeter, verify if the thermostat tripped. Reset the thermostat is needed and verify operation of the cooling fan. Note: the safety thermostat, when open, cuts AC power to the oven relay board (connector J4, pin 1 and 3) and the ESEC relay board (connector J1, pin and 3). **Slide-in dual fuel:** F15 may indicate the safety thermostat tripped, verify thermostat with ohmmeter and verify cooling fan operation. **2)** An F15 error code on the oven controller may indicate the oven controller is not receiving a synchronization signal from the relay board. One easy way to determine this is to power off the unit, power it on and start a Timer for 1 minute before the F15 error code appears. If the timer counts-down normally then the synchronization signal is okay. If the timer stays at 1:00 and does not countdown, then the synchronization signal is missing. If the synchronization signal is missing, check first if the oven relay board is receiving 120VAC correctly (J4 pin 1 and 3). Then check the wiring between connector J2 on the relay board and connector P16 on the oven controller. If AC power and wiring looks good and the problem is still there, replace the relay board. If problem persists, replace the oven controller. **3)** The F15 error code may be caused by an oven controller failure. If the safety thermostat and synchronization signal have been verified and tested good, replace the oven controller.

F20 The oven controller has detected a problem with the communication link to the surface element controller (ESEC). 1) Is the ESEC User Interface Board powered on (are the surface element displays showing something)? If not, that is the reason why the oven control cannot communicate with it (ESEC has no power). Check the 120VAC voltage going in to the ESEC power supply board located in the front console (connector P1) and the low voltage supply going from the power supply board (connector P2) to the ESEC UIB (connector P8). **2)** Check connections between connector P2 on the oven controller and P9 on the ESEC User Interface Board. This is the communication link. Verify for continuity. Refer to the wiring diagram. **3)** If the above steps failed to solve the problem, replace the ESEC UIB board. **4)** If problem persists replace the oven controller.

F23 The controller failed to communicate with the convection fan and oven lights control board. 1) Verify wiring between P2 on the display board and P2 on the convection fan and oven lights control board. **2)** If wiring is good, replace convection fan and oven lights board. **3)** If the problem persists, replace the display board.

F25 No zero cross signal detected on the convection fan and oven lights control board. 1) Make sure L1 and Neutral are connected to the convection fan and oven lights control board on connector P2 (P2 pin 3 = neutral / P2 pin 5 = L1). **2)** If problem persists, replace the oven convection fan and oven lights control board.

F30 Open RTD sensor probe/ wiring problem. Note: EOC may initially display an "F10", thinking a runaway condition exists. F31 Shorted RTD sensor probe / wiring problem. Note: F30 or F31 is displayed when oven is in active mode or an attempt to enter an active mode is made. 1) Check wiring in probe circuit for possible open condition. **2)** Check RTD resistance at room temperature (compare to probe resistance chart). If resistance does not match the chart, replace the RTD sensor probe. **3)** Let the oven cool down and restart the function. **4)** If the problem persists, replace the display board.

F90 Door motor mechanism failure. 1) Press any key to clear the error. **2)** If it does not eliminate the problem, turn off power for 30 seconds, then turn on power. **3)** Check wiring of Lock Motor, Lock Switch and Door Switch circuits. **4)** Unplug the lock motor from the board and apply power (L1) directly to the Lock Motor. If the motor does not rotate, replace Lock Motor Assembly. **5)** Check Lock Switch for proper operation (do they open and close, check with ohmmeter). The Lock Motor may be powered as in above step to open and close Lock Switch. If the Lock Switch is defective, replace Motor Lock Assembly. **6)** If all above steps fail to correct situation, replace the display board and/or the relay board in the event of a motor that does not rotate. **7)** If all the above steps fail to correct the situation, replace the display board in the event of a motor that rotates endlessly.

ELECTRIC AND DUAL FUEL SLIDE-IN OVEN CIRCUIT ANALYSIS MATRIX

	On Relay Board				On Convection Fan and Oven Lights Control Board		On Display Board		On Relay Board		
	ELEMENT			Door Motor J3-5	Light P2-1	Convection Fan P2-7	Door Switch P10-3 / P10-5	Rack Sensor P10-2 / P10-5	DLB L2 out P1	Cooling Fan	
	Bake P9	Broil P7	Conv. P13							Relay 1 J3-7	Relay 2** J3-8
Bake	X	X	X*			X*			X	X	
Keep Warm	X								X	X	
Broil		X							X		X
Conv. Bake	X	X	X			X			X	X	
Conv. Roast	X	X	X			X			X	X	
Conv. Broil		X				X			X		X
Clean	X	X							X	X	X
Locking				X							
Locked											
Unlocking				X							
Unlocked											
Light					X						
Door Open					X		X				
Door Closed											
Bread Proof	X					X				X	
Rack Supports not installed								X			

GAS SLIDE-IN OVEN CIRCUIT ANALYSIS MATRIX

	On Relay Board				On Convection Fan and Oven Lights Control Board		On Display Board		On Relay Board		
	BURNERS		ELEMENT	Door Motor J3-5	Light P2-1	Convection Fan P2-7	Door Switch P10-3 / P10-5	Rack Sensor P10-2 / P10-5	Cooling Fan		
	Bake P9	Broil P7							Conv. P13	Relay 1 J3-7	Relay 2** J3-8
Bake	X								X		
Keep Warm	X								X		
Broil		X								X	
Conv. Bake	X		X			X#			X		
Conv. Roast	X		X			X#			X		
Clean	X								X	X	
Locking				X							
Locked											
Unlocking				X							
Unlocked											
Light					X						
Door Open					X		X				
Door Closed											
Bread Proof			X			X			X		
Rack Supports not installed								X			

■ Relay will operate in this condition only

* Convection element and fan are used for the first rise of temperature.

** Output J3-7 and J3-8 are tied together.

Convection fan starts after a delay of approximately 6 minutes.

RTD SCALE		
Temp. °F	Temp. °C	Resistance (ohms)
32 ± 1.9	0.0 ± 1.1	1000 ± 4.0
75 ± 2.5	23.9 ± 1.4	1091 ± 5.3
250 ± 4.4	121.1 ± 2.4	1453 ± 8.9
350 ± 5.4	176.7 ± 3.	1654 ± 10.8
450 ± 6.9	232.2 ± 3.8	1852 ± 13.5
550 ± 8.2	287.8 ± 4.6	2047 ± 15.8
650 ± 9.6	343.3 ± 5.3	2237 ± 18.5
900 ± 13.6	482.2 ± 7.6	2697 ± 24.4

ELECTRICAL RATING FOR ELECTRIC AND DUAL FUEL OVENS			
Kw Rating 240/208V	See Nameplate	Bake Element Wattage	2500W / 1879W
Broil Element Wattage	4000W / 3004W	Convection Element Wattage	2500W / 1879W

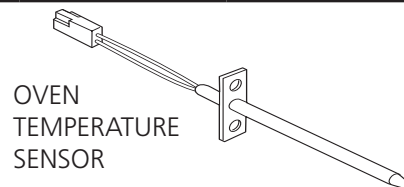

OVEN LIGHT

This appliance is equipped with electronics that control the intensity of the oven lights. This is done with the Convection Fan and Oven Lights Control Board that modulates the AC voltage going to the 120V halogen lamps. When the light key is pressed or when the oven door is opened the display board communicates with the Convection Fan and Oven Lights Control Board to specify the required light intensity. The Convection Fan and Oven Lights Control Board also add a “theater-like” effect on the light: the light intensity is gradually ramp-up or ramp-down as the light is turned on or off.

The lights of the upper and lower oven (warmer oven) are connected together and will turn on or off at the same time, they cannot be controlled individually.

If the oven lights do not operate, check the following:

- If you are getting an F23 error code it means the display board is not able to communicate with the Convection Fan and Oven Lights Control Board, thus the oven light will not operate. Check connections between the display board and the Convection Fan and Oven Lights Control Board. Refer to the fault code section for corrective actions.
- If the lights are always ON (even with the door closed), it could be because the control mistakenly thinks the door is opened. Verify door switch and its wiring.
- Check connections on the Convection Fan and Oven Lights Control Board. On connector P2: pin 3 should be Neutral, pin 5 should be L1 (120VAC) and pin 1 should go to the oven lights. The other terminal of the light should be connected to Neutral.
- Verify is light bulbs need to be replaced.
- If there is no error code, the wiring is good and still the oven lights are not working then replace the Convection Fan and Oven Lights Control Board.

BLOCK DIAGRAM AND SYSTEM INTERCONNECTIONS SLIDE-IN ELECTRIC AND DUAL FUEL

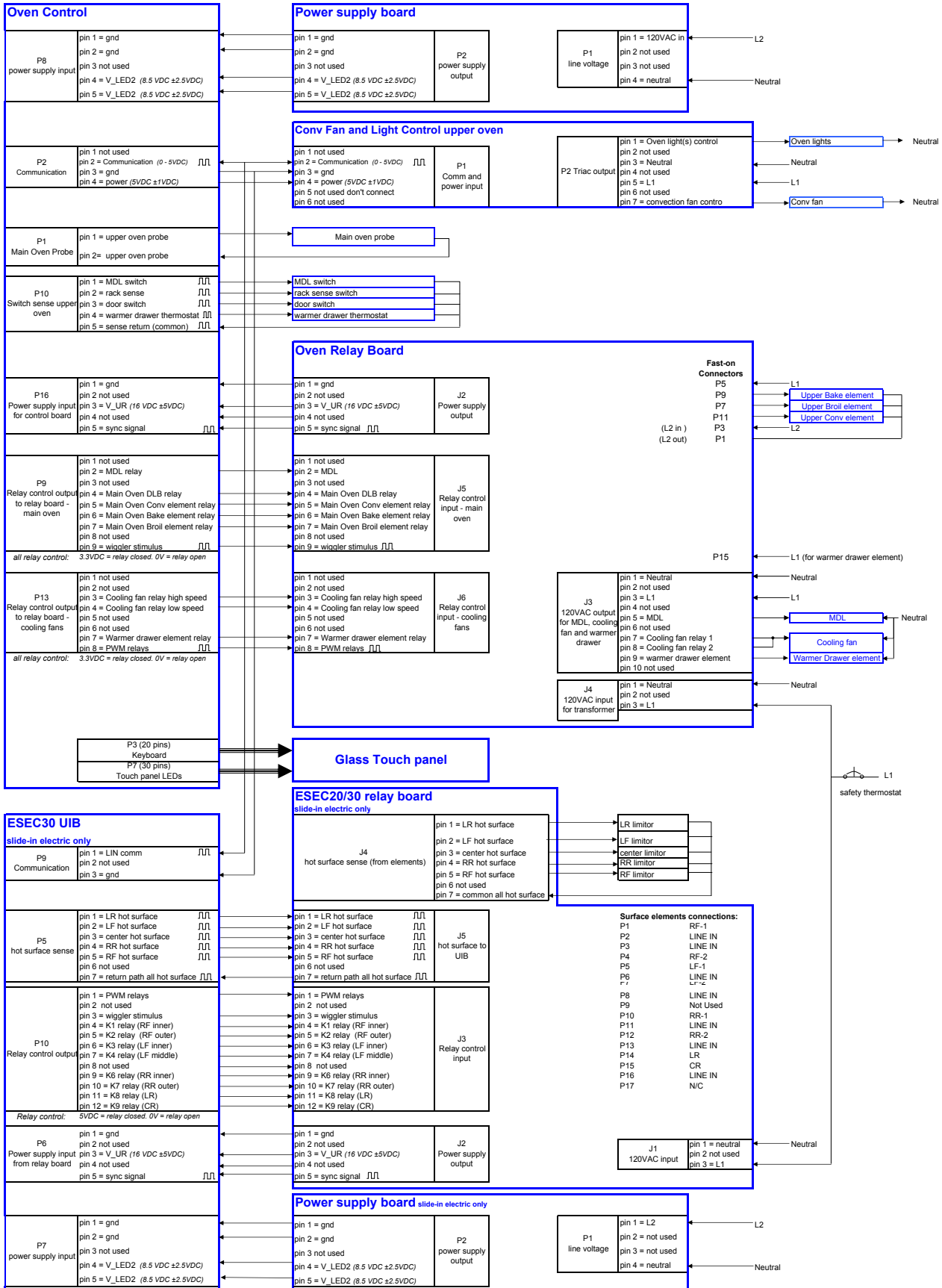

BLOCK DIAGRAM AND SYSTEM INTERCONNECTIONS SLIDE-IN GAS

