

# Installation Instructions

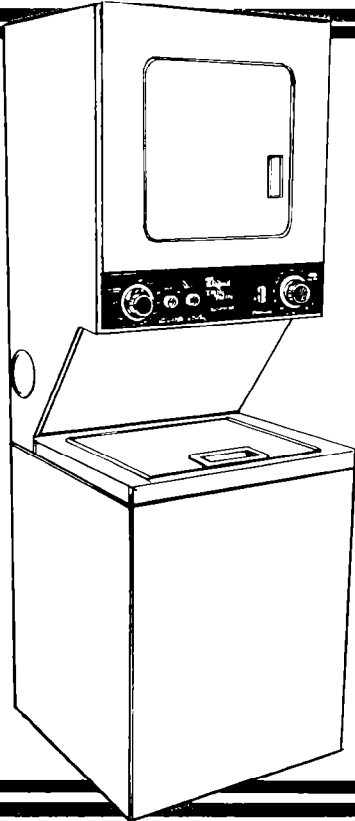

# Whirlpool

Home Appliances

thin twin

**WASHER • DRYER**

**120 VOLT**

Dehumidifiers, Automatic Washers, Clothes Dryers, Freezers, Refrigerators-Freezers, Ice Makers, Dishwashers, Built-in Ovens and Surface Units, Ranges, Microwave Ovens, Compactors, Room Air Conditioners, Dehumidifiers, Automatic Washers, Clothes Dryers, Freezers, Refrigerators

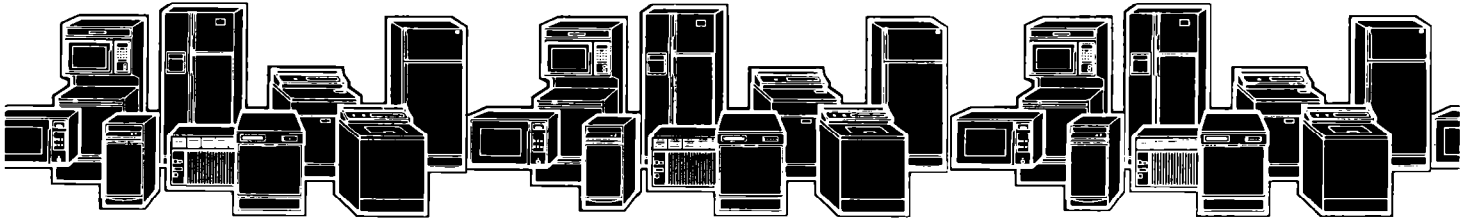

## Before you start...

Mark an X across the letter or number as you complete each step.

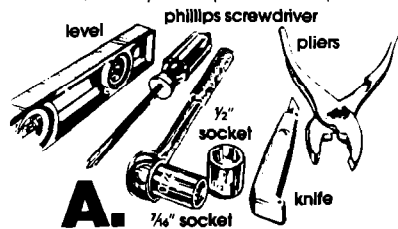

### A. 7/8" socket

You need these tools to install your Whirlpool washer/dryer. Get them together in one place to keep track of them.

### B.

Check the spot where you're going to install the washer/dryer. Proper installation is your responsibility. Make sure you have everything necessary for proper installation. You'll need:

To meet code requirements: some codes keep from or limit installation of clothes dryers in garages, closets, mobile homes and sleeping quarters. (Check with your local building inspector.)

**Important: observe all governing codes and ordinances.**

## Location

**Size:** Must be large enough to fully open dryer door. For recessed or closet installations see Panel E for spacing, for product dimensions see back page of these instructions.

**Support:** The floor must be able to support the appliance weight of 375 pounds.

**Level Floor:** Maximum floor slope under washer/dryer 1 inch.

**Protection from the weather:** Proper operation of dryer cycles requires temperatures above 45°F. As some water remains in the washer do not store or operate the washer below 32°F. For storage below 32°F see Laundry Guide for "Winterizing."

## CAUTION:

- It is the personal responsibility of the customer to ensure that gasoline, paint, thinners and other flammable materials are not used or stored near the washer/dryer. Fumes from these materials could result in fire or explosion.
- Never install the washer/dryer up against draperies or curtains and be sure to keep any and all items from falling or collecting behind the washer/dryer.
- Replace all access or service panels before operating washer/dryer.

## Electrical Requirements

**WARNING: Improper connection of the equipment grounding conductor can result in a risk of electrical shock.**

A 120 volt, 60 Hz, AC only 15 ampere fused electrical supply is required (time-delay fuse or circuit breaker is recommended). If your home has a circuit wired and fused for 20 amperes, this is preferred. If you are installing a new circuit, one wired and fused for 20 amperes is recommended. It is also recommended that a separate circuit serving only this appliance be provided. DO NOT use an extension cord.

## RECOMMENDED GROUNDING METHOD

**Electrical ground is required on this appliance.**

DO NOT, UNDER ANY CIRCUMSTANCES, REMOVE THE POWER SUPPLY CORD GROUND PRONG.

For your personal safety, this appliance must be grounded. This appliance is equipped with a power supply cord having a 3-prong grounding plug. To minimize possible shock hazard, the cord must be plugged into a mating 3-prong grounding type wall receptacle, grounded in accordance with the National Electrical Code, ANSI C1-1984 and local codes and ordinances. See Figure 1. If a mating wall receptacle is not available, it is the personal responsibility and obligation of the customer to have a properly grounded 3-prong wall receptacle installed by a qualified electrician.

For added personal safety, use clamp and green colored copper grounding wire. Connect the grounding wire (#14 minimum) from the external grounding connector on the back of the appliance to a grounded cold water pipe.\*

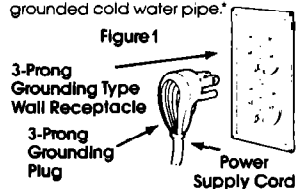

## ALTERNATE GROUNDING METHOD

DO NOT, UNDER ANY CIRCUMSTANCES, REMOVE THE POWER SUPPLY CORD GROUND PRONG.

If changing and properly grounding the wall receptacle is impossible and where local codes permit (consult your electrical inspector), a temporary adapter may be plugged into the existing 2-prong wall receptacle to mate with the 3-prong power supply cord. THIS, HOWEVER, IS NOT RECOMMENDED.

If this is done, you must connect a separate copper grounding wire (#14 minimum) to a grounded cold water pipe\* by means of a clamp and then to the external grounding connector screw. **Do not ground to a gas supply pipe.** Do not connect to electrical supply until appliance is permanently grounded. See Figure 2.

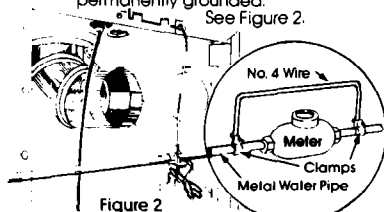

\*Grounded cold water pipe must have metal continuity to electrical ground and not be interrupted by plastic, rubber or other electrical insulating connectors such as hoses, fittings, washers or gaskets (including water meter or pump). Any electrical insulating connector should be jumped as shown in Figure 2 with a length of No. 4 wire securely clamped to bare metal at both ends.

## Exhaust requirements

**Four Inch Metal Exhaust Duct** is required. (Do not use 3 inch exhaust duct.) **Metal** flexible duct may be used. Non-metallic flexible duct is not recommended.

## For Safety:

- Do not exhaust dryer into a chimney, furnace cold air duct, attic or crawl space, or any other duct used for venting. Accumulated lint could become a fire hazard or moisture could cause damage.

- The exhaust system should be cleaned periodically, at least every 2 years.
- Flexible duct should never be installed concealed in walls, ceiling or floor.

## Use Duct Tape

to seal all joints.

**Exhausting the dryer outside** is recommended. If you cannot exhaust the dryer to the outside, use Exhaust Deflector Kit LCK4500 available from your Whirlpool dealer.

**Exhausting the dryer through the side** is available with use of Side Exhaust Kit LCK4600. Follow the installation instructions with the kit for proper exhaust installation.

**For Mobile Home Exhaust Requirements** see Panel E. Alternate Exhaust Methods, for detailed instructions.

**Metal Flexible Duct** must be fully extended and supported when the dryer is in its final position. DO NOT KINK OR CRUSH THE DUCT. The **Exhaust Duct** should end with an exhaust hood to prevent exhausted air returning into dryer. The outlet of the hood must be at least 12 inches from the ground or anything else that may be in the path of the exhaust.

A 2 1/2 inch outlet **Exhaust Hood** should be used with short systems only. This outlet creates greater backward pressure than other hood types.

**Exhaust Hoods** with magnetic latches should not be used. The **Maximum Length** of the exhaust system depends upon the type of duct used, number of elbows and type of exhaust hood. The maximum length for both rigid and flexible duct is shown in chart.

NUMBER OF 90° TURNS	EXHAUST HOOD TYPE			MAXIMUM LENGTH OF 4" DIA. RIGID METAL DUCT.
	4"	4"	2 1/2"	
0	43 FT.	41 FT.	36 FT.	MAXIMUM LENGTH OF 4" DIA. FLEXIBLE METAL DUCT.
1	33 FT.	31 FT.	26 FT.	
2	23 FT.	21 FT.	16 FT.	
0	30 FT.	29 FT.	24 FT.	MAXIMUM LENGTH OF 4" DIA. FLEXIBLE METAL DUCT.
1	24 FT.	23 FT.	18 FT.	
2	16 FT.	15 FT.	10 FT.	

## CAUTION:

**Exhaust Systems** longer than specified will:

- Shorten the life of the dryer.
- Reduce the performance, such as cause longer drying times and increase the use of energy.
- Accumulate lint.

## Water supply and drain requirements

**Hot and Cold water faucets** within 4 feet of back of the washer/dryer and enough pressure (5-100 PSI) are required.

**Water Heater** should be set to deliver 130°F or above water to the washer for best results.

To **Drain** the Whirlpool washer, you need either a 20 gallon laundry tub or a two inch diameter standpipe having a minimum carry-away capacity of 17 gallons per minute.

The top of the tub or the top of the standpipe cannot be lower than 28 inches or higher than 48 inches from the bottom of the washer. Use a floor drain only if a siphon break (air valve to equalize pressure) is installed. (A siphon break, Part No. 285320 is available from Whirlpool authorized parts distributor.)

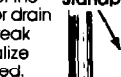
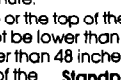
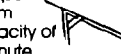
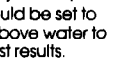
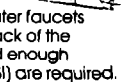
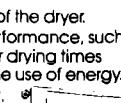
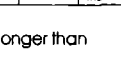
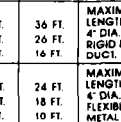
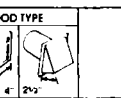
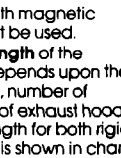
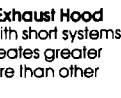
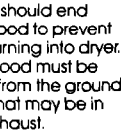
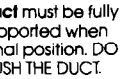
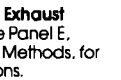
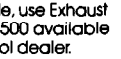

**Now start...**

**1.**

Using a 7/16 inch socket wrench remove the two bolts holding the wood pallet to the bottom of the washer/dryer.

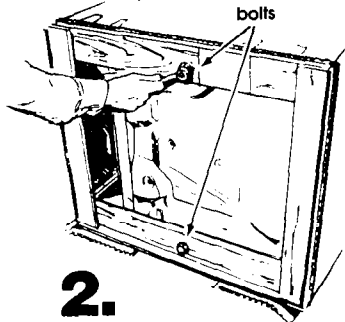

**2.**

Then remove the pallet. Remove all parts from the plastic package. Line these up next to your tools so each part is there when you need it.

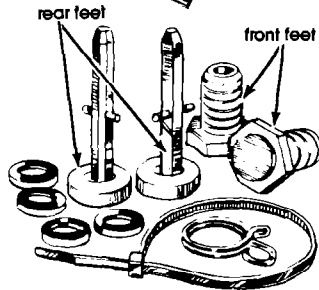
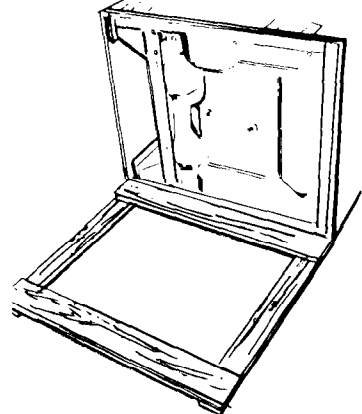

Check to see that you have these parts:

- 4 legs
- 1 plastic strap
- 1 hose clamp
- 4 flat water hose washers

**3.**

Pick up a rear leveling leg; turn it so the flat side and pegs fit into the hole in the rear corner. Push the leg in until it snaps into place. Do the same thing with the other leveling leg in the other rear corner.

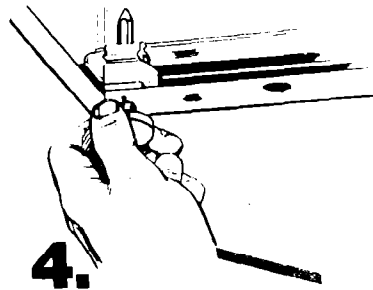
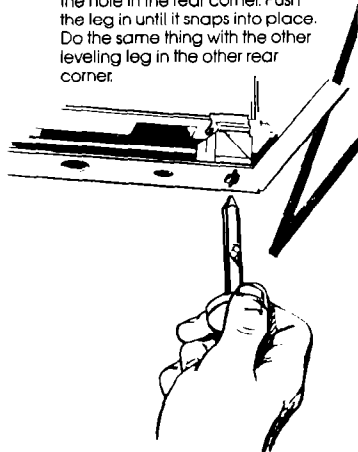

**4.**

When you have both rear legs in, push up on one leg; check to see if the other leg goes down. Check the other leg in the same way. (If the legs don't adjust as they're moved, go through step 3 again.)

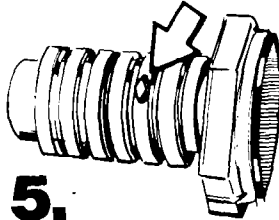

**5.**

With one of the front legs in, check the ridges for a diamond marking. That's how far the leg is supposed to go into the hole in the triangular brace at the front corner of the machine.

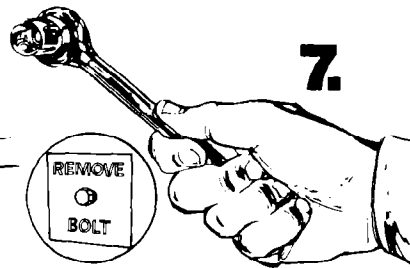

**7.**

Look for the shipping bolts – these are the largest bolts and have red labels beneath the bolt heads. Using a 1/2" wrench, remove only the two shipping bolts. **DO NOT** remove the three smaller bolts as they are part of the suspension system.

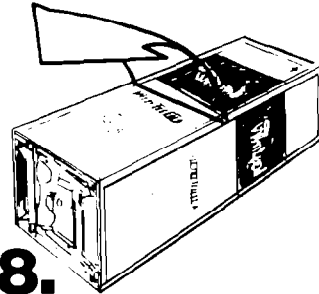

**8.**

With the washer/dryer still in the carton stand the washer/dryer upright.

**Because of the weight and size of the washer/dryer, two people are required.**

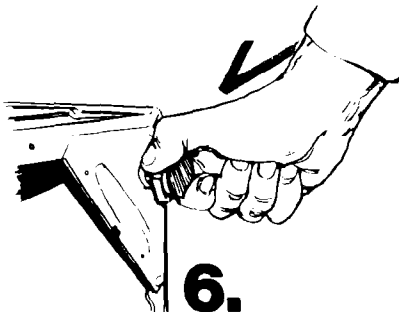
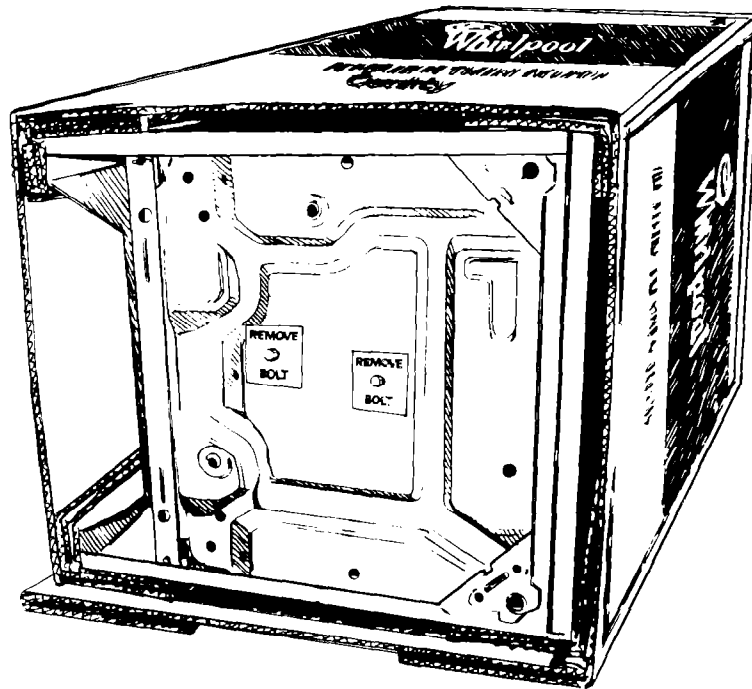

**6.**

Start to screw the front legs into the hole by hand. A little liquid detergent to lubricate the screw will help. (You'll need pliers to turn the leg all the way to the diamond.)

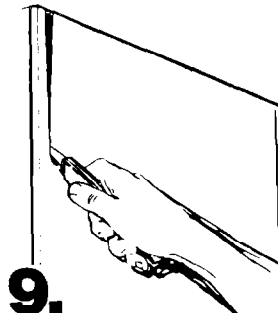

**9.**

Cut carton down one corner. To prevent appliance damage do not remove corner post before cutting down the corner. Remove the carton.

**10.**

Remove the packing pieces attached to the outside of the washer/dryer except the two blocks between washer and dryer. Do not remove the blocks between the washer and dryer until unit is in place. You should have these pieces:

- 2 front corner pieces
- 2 rear corner pieces
- 1 dryer cover

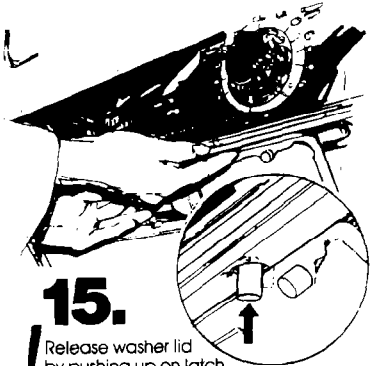
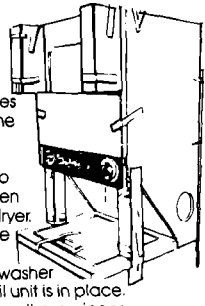

**15.**

Release washer lid by pushing up on latch. Close lid.



**17.**

Before you're ready to attach water supply hoses, run a little water from the faucets. This gets rid of any particles that might clog the hoses. Use the new hoses and flat washers that come with your Whirlpool washer/dryer.

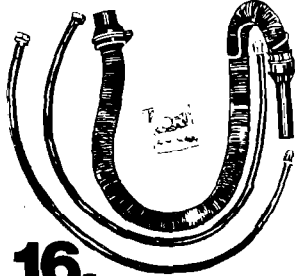

**16.**

Place hoses and other parts by your tools. Remove all parts from the plastic package and check to see that you have these parts:

- 2 washer hoses
- drain hose
- copper grounding wire
- grounding clamp with screw

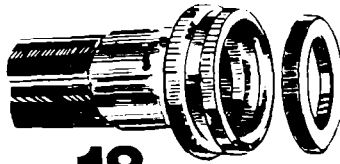

**18.**

Now place a flat washer into each end of the inlet hoses. (Check to make sure washers are firmly seated in couplings.) Attach hoses to faucets. Tighten couplings by hand, then make a final two-thirds turn with pliers.

**11.**

Untape and open washer lid. Latch under the dryer will hold lid open.

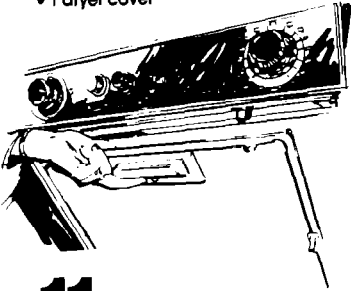

**12.**

Remove foam shipping piece.



**13.**

Now check to see that you have all these shipping pieces.

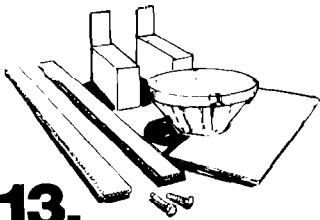

**14.**

Remove hoses and parts package from inside the washer.

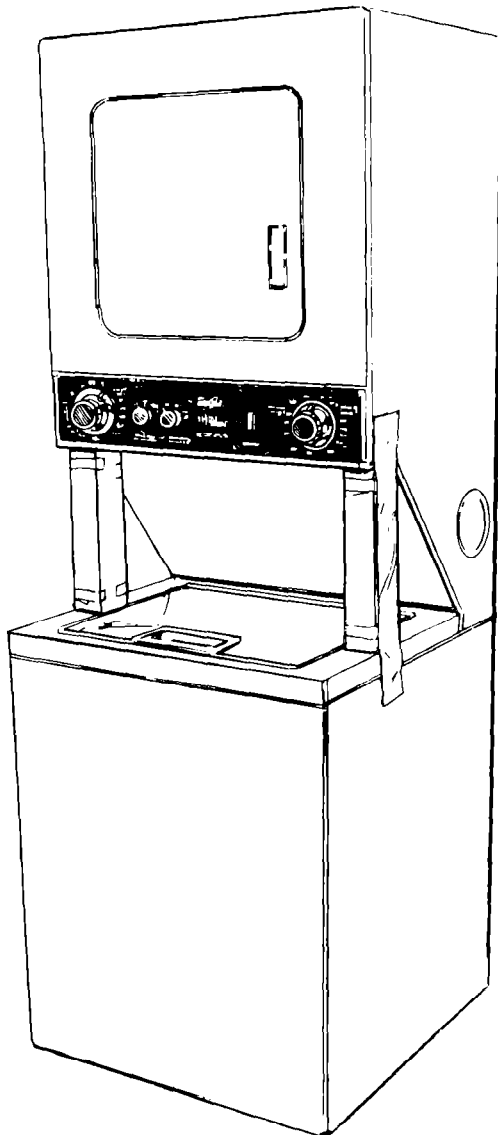
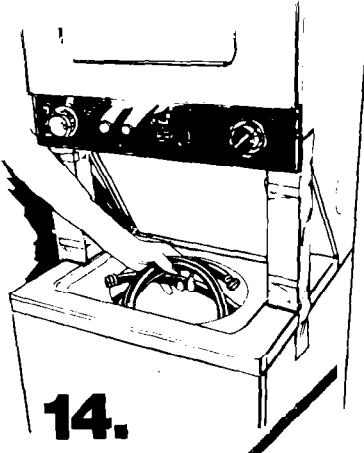

Do not remove the blocks between the washer and dryer until unit is in place.

## 19.

Washer fill hoses, drain hose and electrical cord can be connected before moving the washer/dryer into final position if work space permits. (For installation in recessed, closet or mobile home locations see Alternate Installations, Panel E.)

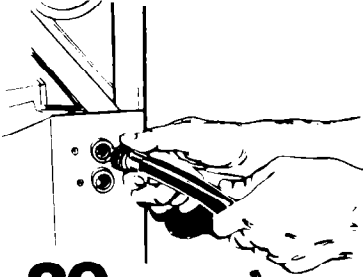

## 20.

Attach the hose from the hot water faucet to the bottom inlet valve opening (marked "H") on the washer. The cold water hose attaches to the top inlet valve opening (marked "C"). Tighten couplings by hand, then make an additional two-thirds turn with pliers.

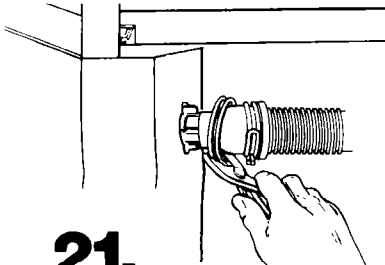

## 21.

**Remove plug from connector.** Place the hose clamp on the drain connector. Next, take the drain hose and firmly push the coupling end over the connector. Using pliers, open the clamp on the connector and slide it up and over the drain hose. Release and check for good fit. Move the washer close to its final position. Put the "hook" end of the drain hose in the laundry tub or standpipe.

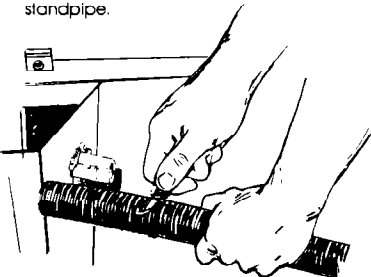

## 22.

If the drain hose is too long - disconnect the drain hose. Remove the coupling and clamp from the hose. Estimate how long the drain hose should be. Cut the flexible end of the hose to the correct length. (**Do not cut the hook-shaped end of the drain hose.**) Push and twist the coupling securely onto the drain hose. (You should be able to feel the top of the drain hose through the coupling.) Slide the clamp over the coupling and hose. Re-install the drain hose as described in step 21.

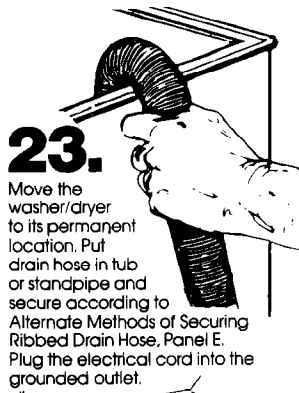

## 23.

Move the washer/dryer to its permanent location. Put drain hose in tub or standpipe and secure according to Alternate Methods of Securing Ribbed Drain Hose, Panel E. Plug the electrical cord into the grounded outlet.

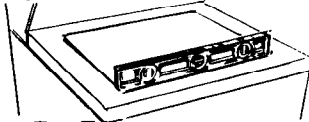

## 24.

To make sure the washer is level, take a carpenter's level and place it on the top of the washer, first side to side, then front to back. If you do not have a level take your Whirlpool Operating Instructions; turn to the page where the controls are shown. Following those directions, (open washer lid) fill the water basket to any given row of holes, then stop the washer. Check to see if the water meets the holes all the way around the basket. If it does not, screw the front feet of the washer up or down to adjust. Then tilt the machine forward and the back legs will self-adjust.

## 26.

To exhaust the dryer straight from back of the washer/dryer unit or to either side, determine if any additional exhaust duct is needed (see exhaust requirements, Panel A). To exhaust the dryer inside see Alternate Exhaust Methods, Panel E. Connect exhaust duct to exhaust hood.

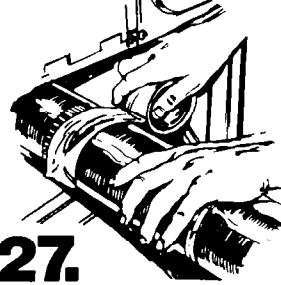

## 27.

Use duct tape to seal all joints.

## 28.

With the washer control in the "OFF" position, turn on the water faucets and check for leaks. Tighten couplings if necessary. Also check power cord to make sure it is not pinched.

## 29.

Replace access panel. Be sure to tighten both screws.

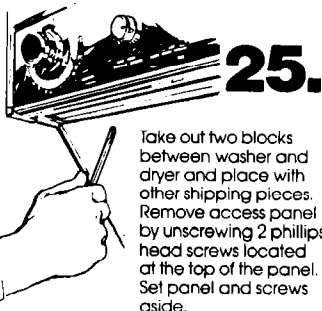
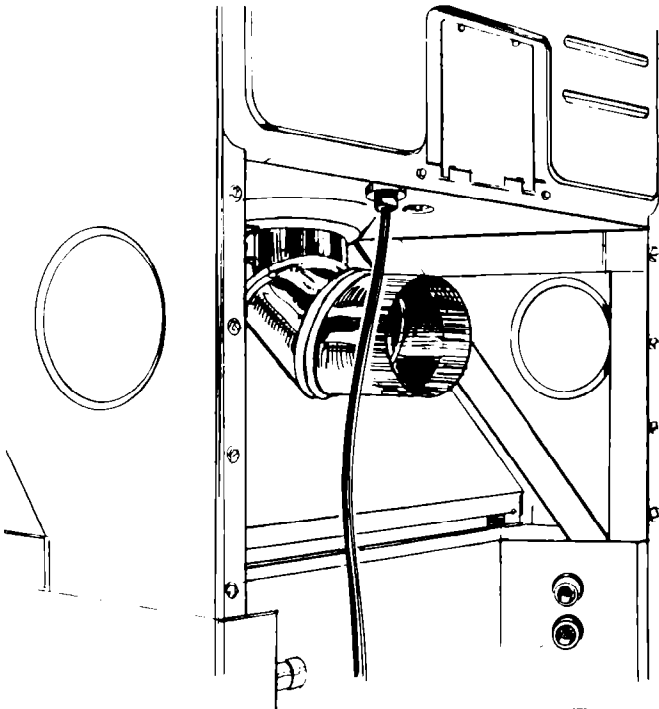

## 25.

Take out two blocks between washer and dryer and place with other shipping pieces. Remove access panel by unscrewing 2 phillips head screws located at the top of the panel. Set panel and screws aside.

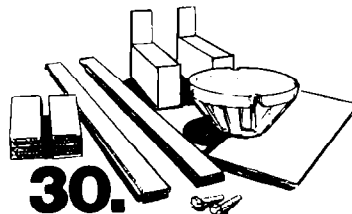

## 30.

Check to see if you have all of these shipping pieces removed from the washer/dryer. If you don't remove all the shipping materials, the washer/dryer may "walk" away from its location...it's happened! If you are missing a shipping piece go back through the steps to see what you skipped.

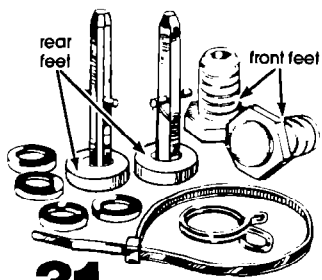

### 31.

Now check to see that all of the parts you removed from the installation parts bag in step 2 are now installed in the washer/dryer. If you still have an extra part, go back through the steps to see what you skipped.

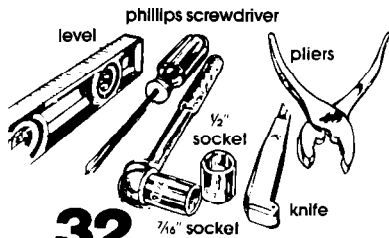

### 32.

Check to make sure you have all the tools you started with.

**33.** Take a few minutes to read the Use and Care Guide so you can get the best use from your new washer/dryer. Now start the washer and allow it to complete one cycle (such as the permanent press cycle.)

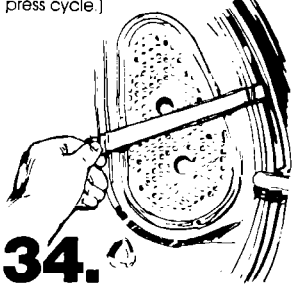

### 34.

Remove tape from dryer door. Open door and remove the tape that holds the lint screen in place. Check to be sure lint screen is in its proper position. Wipe out drum. Start dryer and allow it to complete a cycle to make sure the dryer is working properly.

**35.** Finally, save all literature and keep with the washer/dryer. Save all shipping materials for reshipping.

Use caution when moving this appliance to prevent damage to floor coverings. The weight of the appliance may cause tipping, scratching or other damage to the floor. For BEST RESULTS slide appliance onto cardboard or fiberboard before moving to prevent damage.

**Congratulations!**

You have just finished installing your new Whirlpool washer/dryer.

### Alternate installations: recessed or closet area locations.

The following are minimum installation spacings and openings (in inches) that you should allow. For easier installation and service, consider additional spacing.

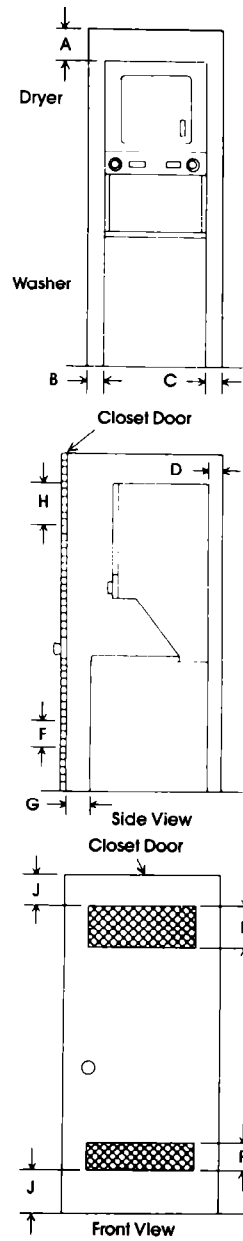

When the washer/dryer is installed in other than the recessed and closet type of installation shown, minimum dimensions indicated must be observed. To prevent large amounts of lint and moisture from accumulating and to maintain drying efficiency, this appliance must be exhausted outdoors. Non-exhausted installation – only rear exhaust position permitted. Exhaust Deflector Kit LCK4500 must be used.

### Alternate methods of securing ribbed plastic drain hose

**A.** Put the bent end of the ribbed plastic drain hose in the tub or standpipe.

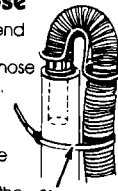

Figure 3

**B.** The drain hose must be held securely with the plastic strap provided so it does not come out of the tub or standpipe during use.

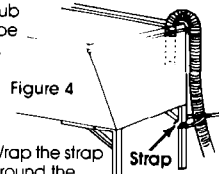

Figure 4

**C.** Wrap the strap around the drain hose, and secure as shown in Figures 3 Standpipe, 4 Tub, 5 in-wall standpipe.

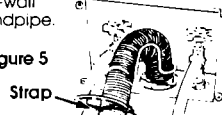

Figure 5

**D.** If the drain hose cannot be strapped in place, it must be cut exactly to length so the bent end is held tightly over the edge of the tub or standpipe (see Figure 6.)

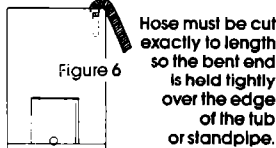

Figure 6

BE SURE THE HOSE IS NOT TWISTED OR KINKED AND IS SECURELY IN PLACE

### Alternate exhaust methods.

**A.** There are exhaust kits available that allow you to direct filtered exhaust air inside to conserve energy during winter months. You may use these devices with Whirlpool dryers providing their use does not violate national or local codes, and the device does not restrict exhaust air flow. If you use one of these kits, be aware that excessive moisture in the home can cause many problems and that you may see an increase in the time required to dry a load. Also, you must maintain the kit installation properly to avoid excessive lint build-up, which can affect the dryer's performance.

**B.** For mobile home installation, the dryer must have an outside exhaust. If you exhaust the dryer through the floor and the area under your mobile home is enclosed, the exhaust system must terminate outside the enclosed area. Extension beyond the enclosure will prevent lint and moisture build-up under the mobile home. See Figure 7.

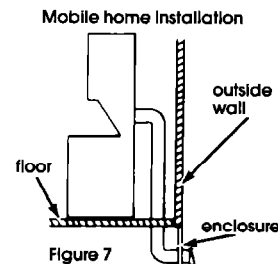
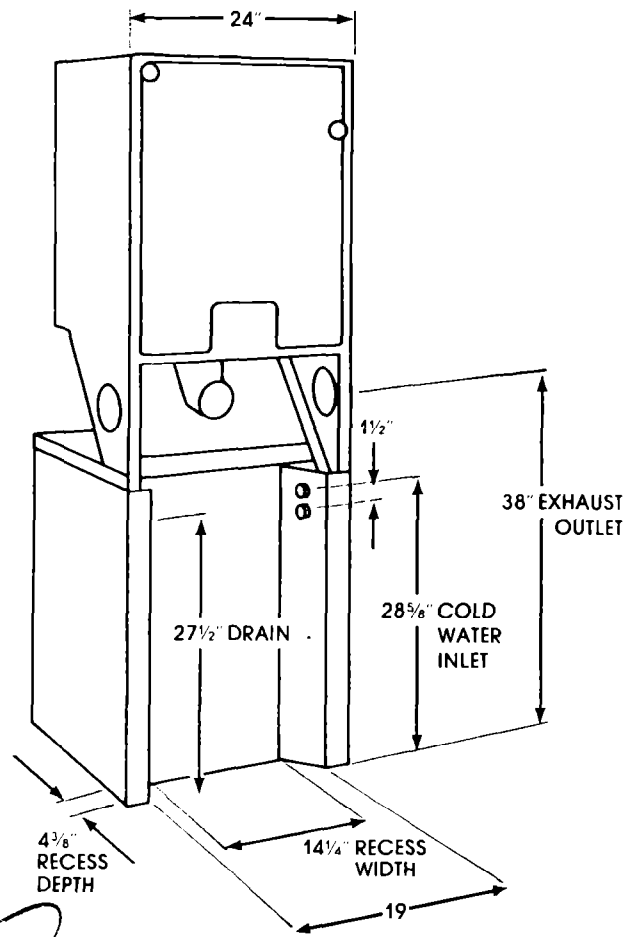
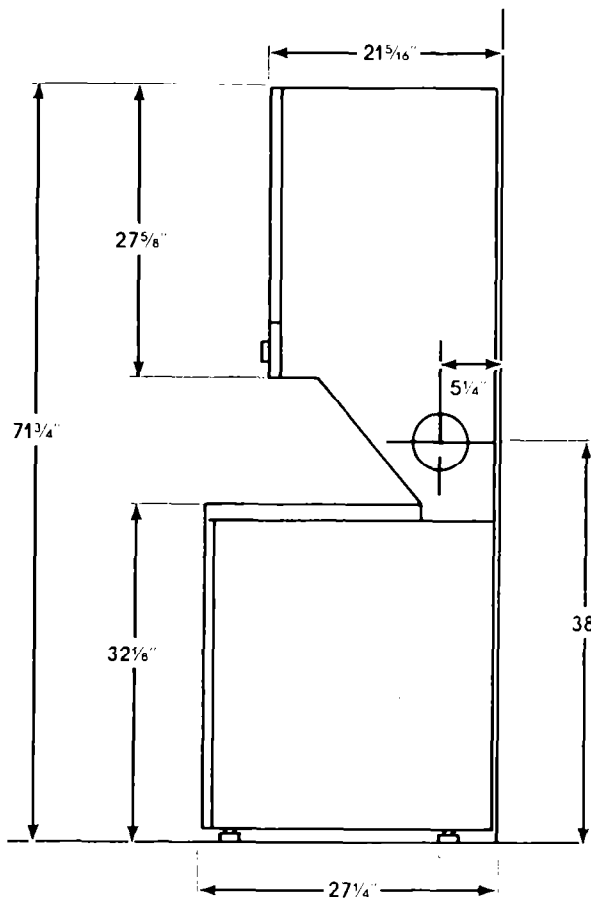

Figure 7



Part No. 697084

Prepared by Whirlpool Corporation, Benton Harbor, Michigan 49022

Printed in U.S.A.