

use & care guide

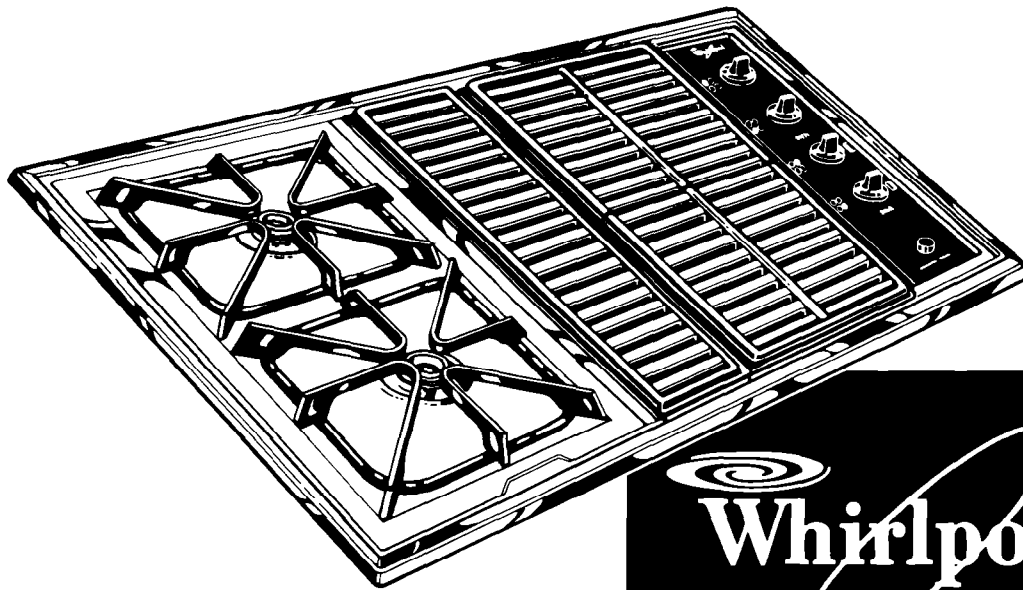

Gas Model
SC8900EMH

The Whirlpool logo consists of the word "Whirlpool" in a bold, serif font, with a stylized swirl graphic above the letter 'i'.

**MODULAR
DOWN DRAFT
COOKTOP**

ers, Freezers, Refrigerator-Freezers, Ice Makers, Dishwashers, Built-In Ovens and Surface Units, Ranges, Microwave Ovens, Trash Compactors, Room Air Conditioners, Dehumidif

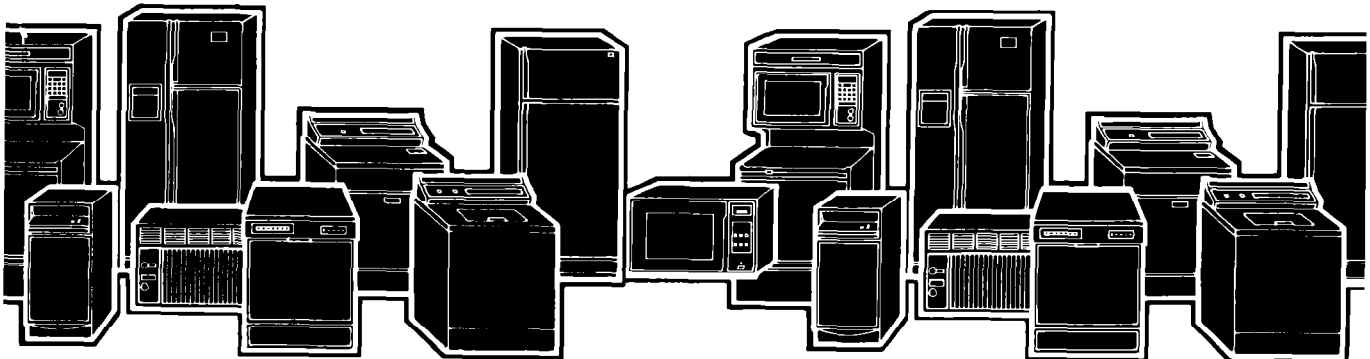

Contents

	Page		
BEFORE YOU USE YOUR COOKTOP	2	USING OPTIONAL MODULES	9
IMPORTANT SAFETY INSTRUCTIONS	2	Using the Griddle	9
PARTS AND FEATURES	4	Using the Rotisserie	10
USING YOUR COOKTOP	5	CLEANING AND CARING FOR YOUR COOKTOP	12
Surface Burner Indicators	5	Control Panel and Knobs	12
Using the Control Knobs	5	Cleaning Cooktop Modules	13
Using the Vent System	6	Cleaning the Vent System	14
Using the Grill	6	IF YOU NEED SERVICE OR ASSISTANCE	15
CHANGING COOKTOP MODULES	8	1. Before Calling for Assistance	15
		2. If You Need Assistance	15
		3. If You Need Service	15
		4. If You Have a Problem	15

©1984 Whirlpool Corporation

Before you use your cooktop



Read this "Use and Care Guide" and the "Cooking Guide" carefully for important use and safety information.

You are personally responsible for making sure that your cooktop...

- is installed by a qualified installer.
- is properly installed and leveled in a countertop and cabinet that can support the weight.
- is installed in an area protected from the weather.
- is properly connected to the proper gas supply and checked for leaks. (See "Installation Instructions".)
- is properly connected to the correct electric supply and properly grounded. (See "Installation Instructions".)
- is vented according to manufacturer's instructions, with no restrictions.
- is properly maintained.
- is used only for jobs expected of home cooktops.
- is not used by children or anyone unable to operate it properly.
- See the "Installation Instructions" for complete information.



Important safety instructions

WARNING – When using your cooktop, follow basic precautions, including the following:



DO NOT store things children might want over the cooktop. Children climbing on the cooktop to reach items could be seriously injured.

DO NOT allow children to use or play with the cooktop, or leave them unattended near it.

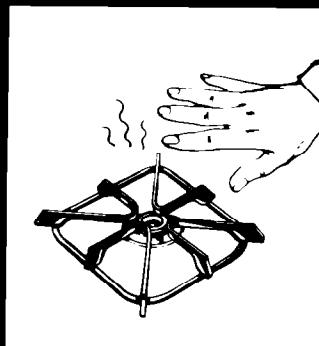

DO NOT touch hot surface burners. Areas around burners can still be hot enough to burn severely.

DO NOT use a cooktop to heat a room

• FOR YOUR SAFETY •
DO NOT STORE OR USE GASOLINE OR OTHER FLAMMABLE VAPORS AND LIQUIDS IN THE VICINITY OF THIS OR ANY OTHER APPLIANCE.

• FOR YOUR SAFETY •
IF YOU SMELL GAS:
1. OPEN WINDOWS.
2. DON'T TOUCH ELECTRICAL SWITCHES.
3. EXTINGUISH ANY OPEN FLAMES.
4. IMMEDIATELY CALL YOUR GAS SUPPLIER.

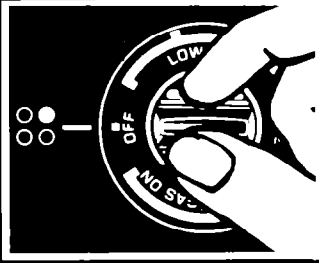

MAKE SURE surface burners are off when you are finished, and when you aren't watching.

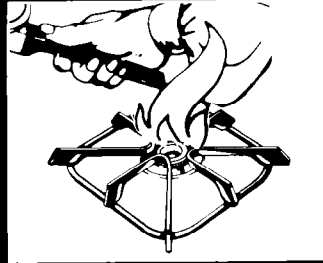

DO NOT wear loose or hanging garments when using the cooktop.

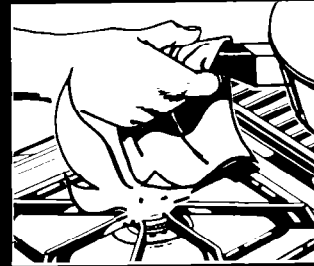

DO NOT use a towel or other bulky cloth as a pot holder.

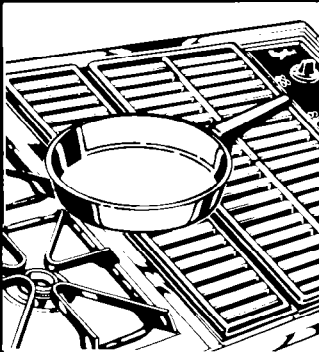

DO NOT block the vent system.

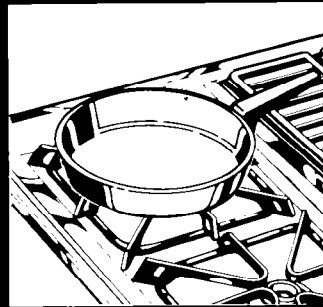

KEEP pan handles turned in, but not over another surface burner.

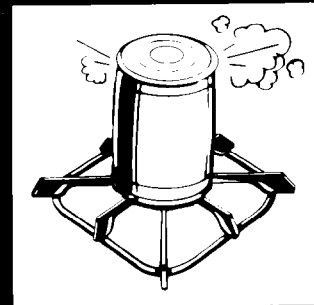

DO NOT heat unopened containers. They can explode.

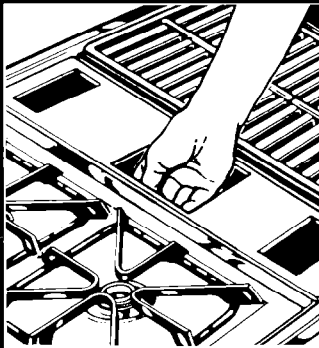

DO NOT put hands in vent box when fan is ON. Injury could result.

BE SURE all cooktop parts are cool before cleaning.

Filters must be in place for proper safe operation.

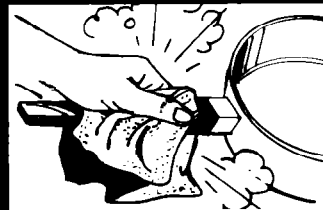

DO NOT use a wet pot holder. Steam burns can result.



DO NOT use water on grease fires.

DO NOT use gasoline or other flammable materials to clean the cooktop.

DO NOT use utensils (pots and pans) on the grill module.

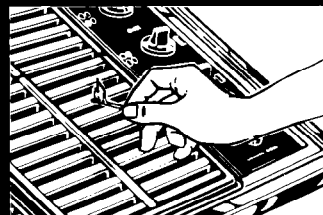

NEVER use a match or other flame to look for a gas leak.

— SAVE THESE INSTRUCTIONS —

When servicing the unit, the power cord must be removed from the wall electrical outlet.

Parts and features

Model SC8900EMH

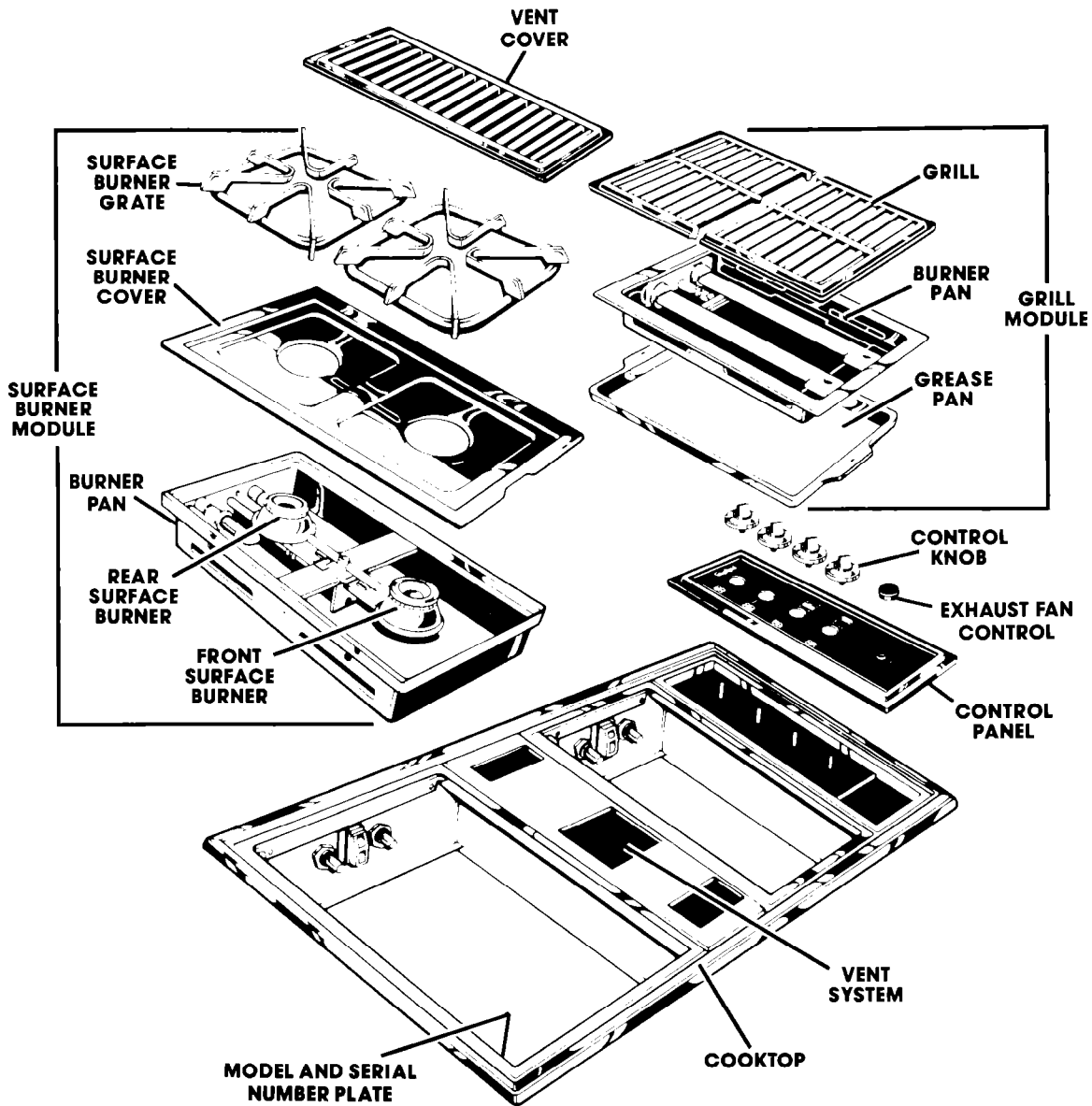

Copy your Model and Serial Numbers here...

If you need service or call with a question, have this information ready:

1. **Complete** Model and Serial Number (under the left module on the left wall).
2. Purchase date from sales slip.

Copy this information in these spaces. Keep this book, your warranty and sales slip together in a handy place. There is no warranty registration to return. Proof-of-purchase is all that is required for in-warranty service.

Model Number _____

Serial Number _____

Purchase Date _____

Service Company Phone Number _____

Using your cooktop

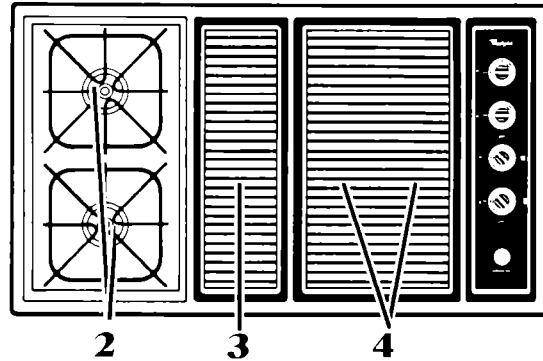
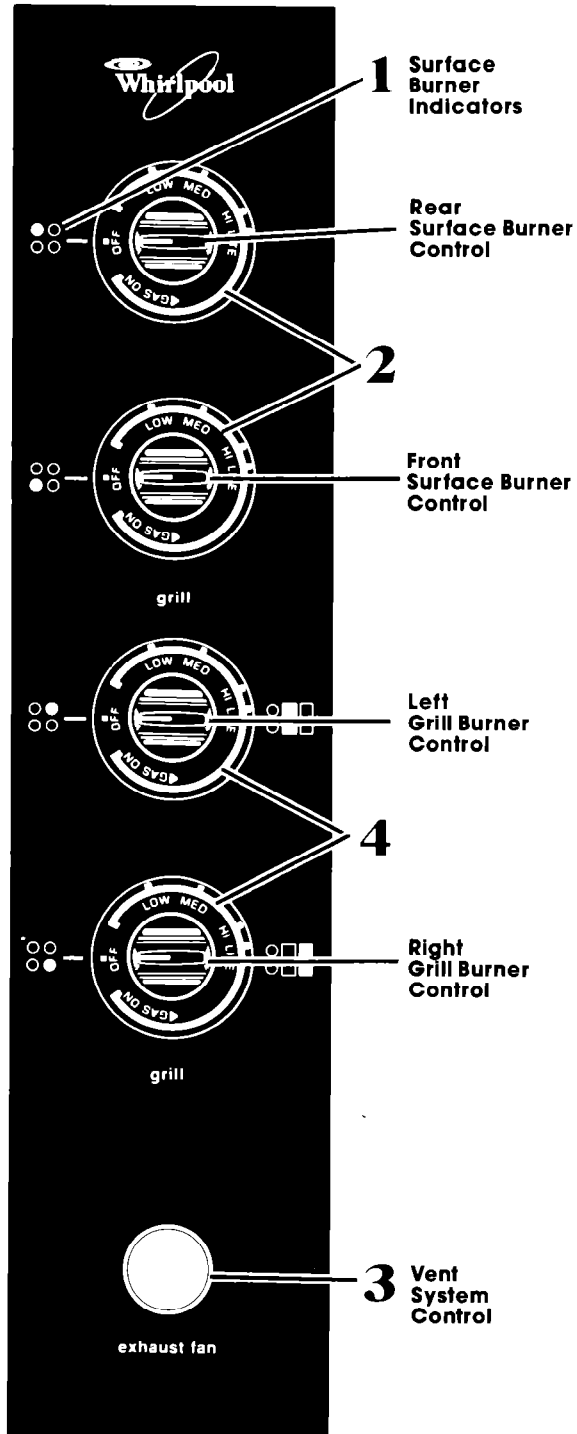

1. Surface burner indicators

Surface burner indicators show the surface burner or module operated by that control knob.

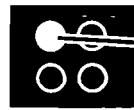

- The solid dot shows the surface burner that is controlled by that knob.



- The solid box shows the burner inside the burner pan that is controlled by that knob. **To operate the grill, griddle or roisserie, both burner control knobs must be turned ON.**

2. Using the control knobs

Control knobs must be pushed in, then turned to the LITE position. The clicking sound is the ignition sparking.

PUSH IN
Turn to
START.

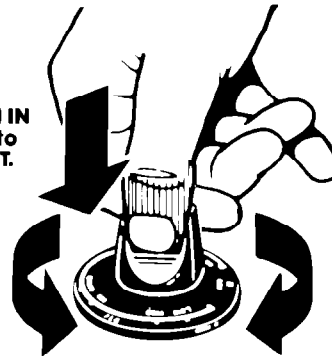

Turn Back
to Setting.

To stop the clicking sound after the burner lights, turn the control knob back to a desired setting. The control knob has markings for HI, MED and LOW, however it can be set anywhere between HI and OFF. **Do not cook with the control in the LITE position.**



WARNING: If the flame should go out while cooking, or if there is a strong gas odor, turn the burners OFF. Wait five minutes for the gas odor to disappear, before relighting burner. If gas odor is still present, see safety note on page 2.

In case of a prolonged power failure

Surface burners can be manually lighted. Hold a lighted match near a burner and slowly turn the control counterclockwise until the burner lights. Since the vent system will not operate, smoke and steam will not be vented out of the room.



Using the surface burners

For best cooking results, set the flame size halfway between the center and the edge of the cooking utensil bottom. A covered utensil retains heat so a smaller flame size can be used.

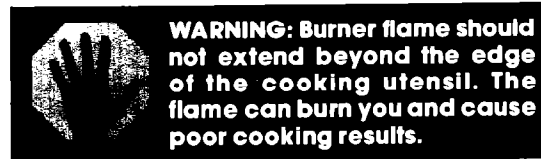

Until you get used to the settings, use the following as a guide.

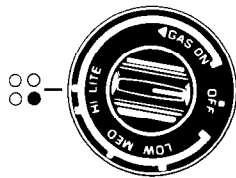

Use **LITE** to light the burner. After the burner lights, turn control back to a desired setting to stop the clicking of the ignition. **Do not cook with the control in the LITE position.**

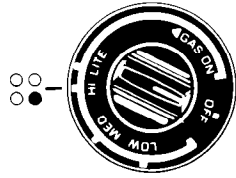

Use **HI** to start foods cooking or to bring liquids to a boil.

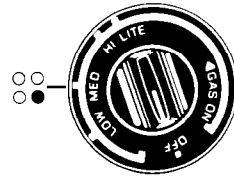

Use **MED** to continue cooking or to fry chicken or pancakes; for gravy, puddings and icing or to cook large amounts of vegetables.

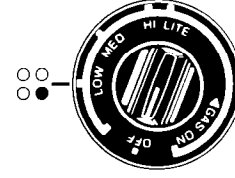

Use **LOW** to keep foods warm until ready to serve.

3. Using the vent system

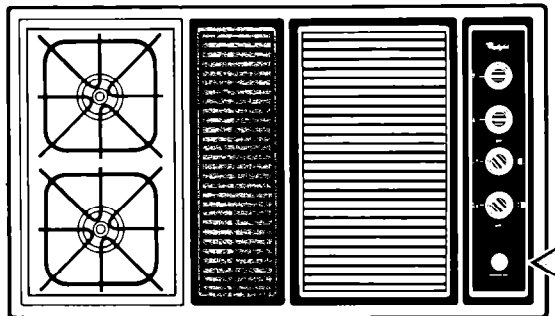

The built-in exhaust fan removes most cooking vapors, odors and smoke from foods during cooking.

- Turn the exhaust fan control knob clockwise to turn the fan **ON**.
- Turn the knob counterclockwise to turn the fan **OFF**.
- The exhaust fan will **automatically** come on and stay on whenever the grill, griddle or rotisserie is turned on.

FILTERS MUST BE IN PLACE FOR PROPER SAFE OPERATION.

THE EXHAUST FAN SHOULD BE ON FOR MOST COOKING OPERATIONS.

DO NOT PUT HANDS IN VENT BOX WHEN FAN IS ON. INJURY COULD RESULT.

4. Using the grill

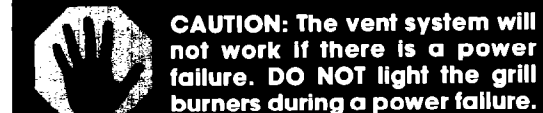
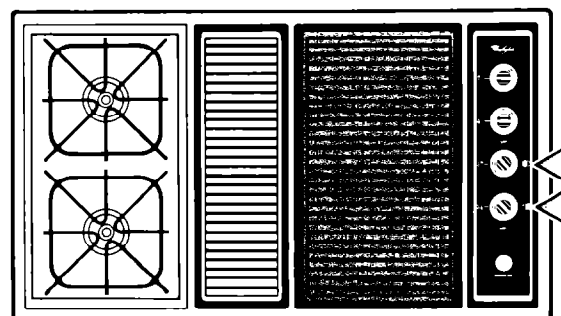

Before using the grill for the first time:

- Wash, rinse and dry grill.
 - Use warm sudsy water.
 - **DO NOT** use metal scouring pads or abrasive cleanser. They will damage the non-stick coating on the grill.
- Lightly wipe with cooking oil to prevent the meat from sticking.

Approximate minimum grill cooking times

Both burners must be ON to get proper grilling results. Preheat the grill for 10 minutes on HI, then set control to MED before placing food on grills. This helps avoid excessive flare-ups.

Food	Cook Setting	Approximate Cooking Time	
		Side 1	Side 2
Beef			
Steak (½"-¾")			
Rare	MED	5 Min.	4 Min.
Medium	MED	6 Min.	6 Min.
Well Done	MED	7 Min.	7 Min.
Steak (1-1½")			
Rare	MED	5-6 Min.	5 Min.
Medium	MED	9-10 Min.	10 Min.
Well Done	MED	12-13 Min.	12 Min.
Others (These foods must be turned and rearranged as necessary during cooking to provide the most even cooking results.)			
Smoked Sausage (2lbs.)			
Med to Well	MED	7 Min.	5 Min.
Hamburgers	MED	10 Min.	10 Min.
Ham Slice	MED	15 Min.	10 Min.
Pork Sausage	MED	4 Min.	3 Min.
Pork Chops	MED	15 Min.	10 Min.
Hot Dogs	MED	4 Min.	3 Min.
Chicken Pieces	MED	25 Min.	20 Min.



CAUTION: The use of metal forks and tongs can scratch the non-stick grill finish. Use with care.

Hints and tips:

1. Foods cooked on the grill can spatter. It is important to clean all parts after each use. See page 13.
2. The burner pan can be cleaned in warm sudsy water or in a dishwasher. See page 13.
3. Trim fats from meat before grilling to prevent excessive smoke and flare-up. Meats which normally have a high fat content will produce more smoke and flare-up and will cook faster than lean meat.
4. Be sure grease pan is installed under the burner pan to catch fat drippings during grilling.
5. Take the grill apart to clean and to remove and store. **Do not stack when storing.**
6. Do not cover the grill completely with meat. Leave space between the food items to allow proper smoke and steam removal.
7. Use only nylon or plastic utensils. Metal can scratch the non-stick finish.
8. Do not grill with the controls on the HI setting. Excessive smoke and flare-up could result.
9. If meat begins to cook too quickly, turn the grill control knob to a lower setting.



WARNING –
If grease causes excessive flare-ups:

1. Remove food from grill.
2. Turn the grill OFF.
3. Make sure the vent system is ON.
4. Do not put water on grease fires.

Changing cooktop modules

Make sure all controls are OFF and the cooktop parts are cool before removing them.

Surface burner modules

Surface burner module will work on either side of the cooktop.

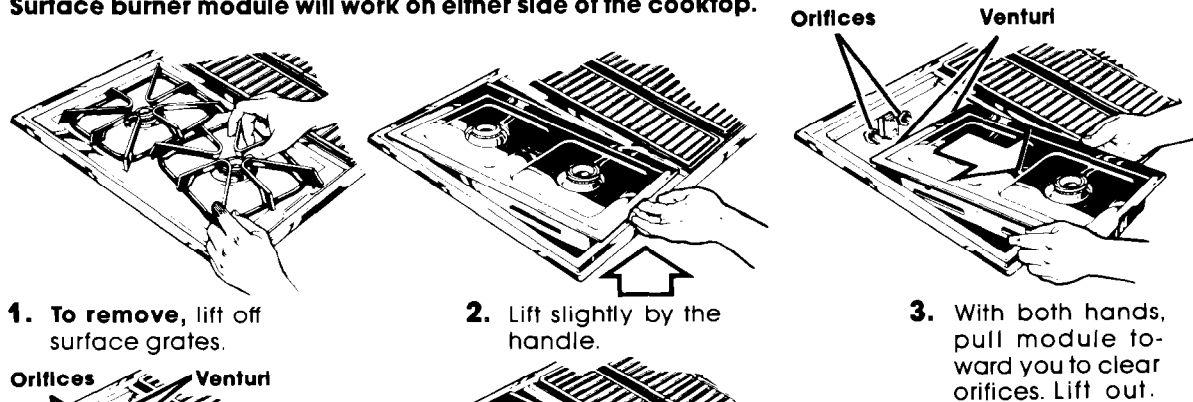

1. To remove, lift off surface grates.

2. Lift slightly by the handle.

3. With both hands, pull module toward you to clear orifices. Lift out.

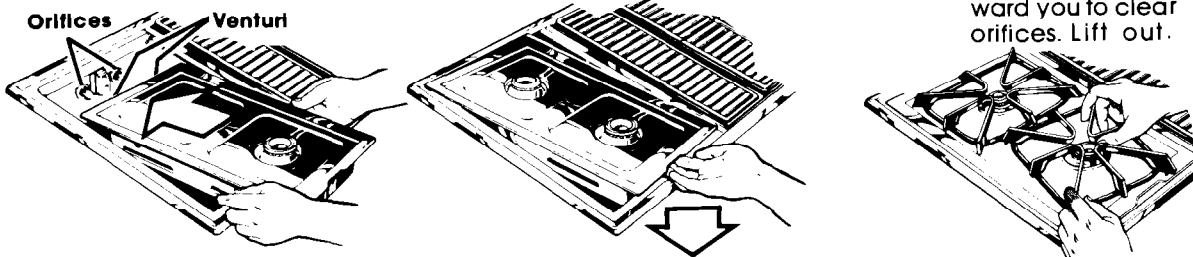

1. To replace, line up the venturi with the burner orifices.

2. Push the module until it's seated properly.

3. Lower front with the handle.

4. Install surface grates.

Grill module

Grill module will work on the right side of the cooktop only.

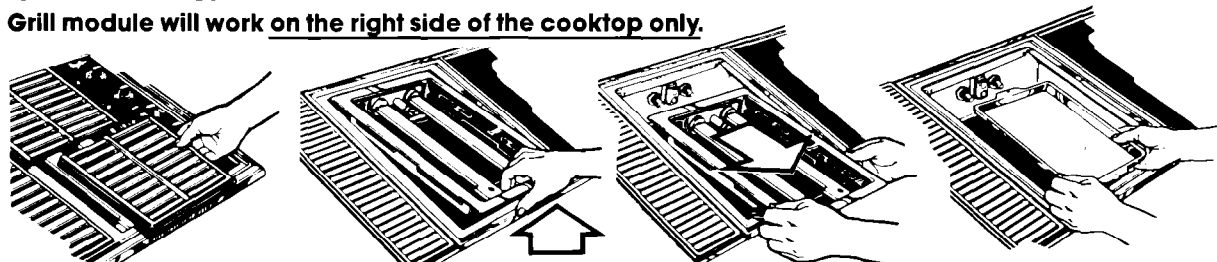

1. To remove, lift off grills.

2. Lift front end of burner pan and pull toward you.

3. With both hands, lift burner pan out and set aside.

4. Lift out the grease pan, being careful not to spill fat drippings.

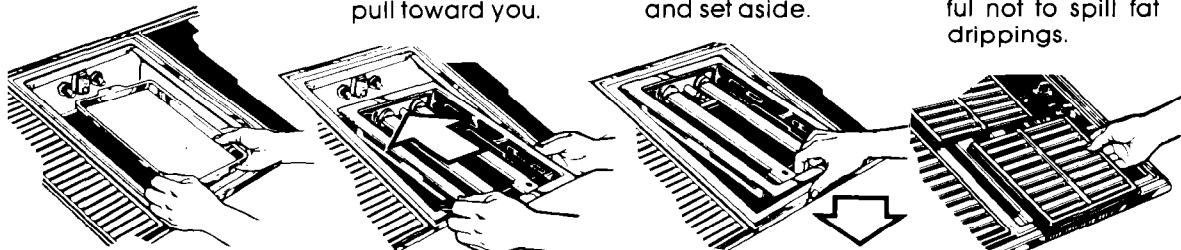

1. To replace, insert the grease pan. Do not use the grill module unless the grease pan is in place.

2. Line up the venturi with the burner orifices.

3. Push burners into place while lowering burner pan.

4. Place grills over burners.

All grill parts must be cleaned after each use to avoid excessive smoke, flare-ups, fat spoilage and odors. See page 13.

Using optional modules

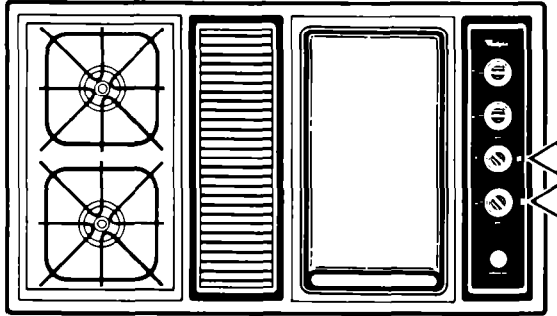

Optional modules will work on the right side of the cooktop only.

Make sure the grill controls are OFF, and the grill parts are cool before changing modules.

Grill module controls are as shown.

Using the griddle

NOTE: Make sure the grill controls are OFF and the grill is cool before installing griddle.

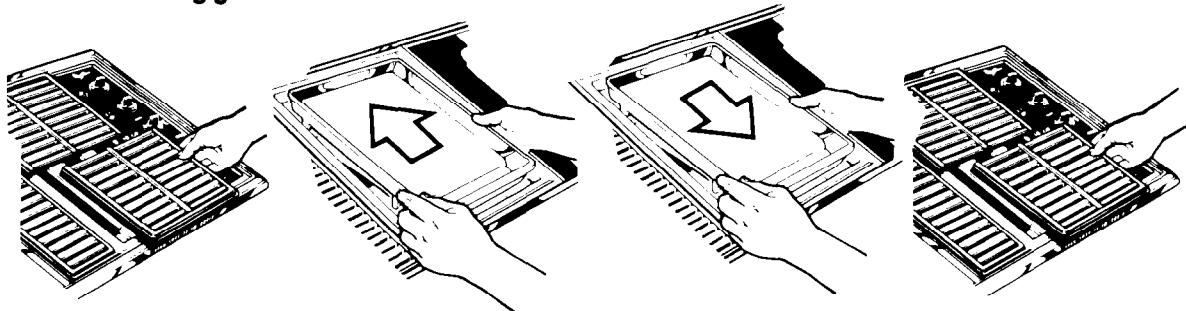

1. To install, remove the grills.

2. Place griddle over burners with drain slot in front.

1. To remove, lift out griddle and set aside. **Make sure the griddle is cool before removing.**

2. Replace the grills.

Before using the griddle for the first time:

- Wash, rinse and dry griddle.
 - Use warm sudsy water.
 - DO NOT** use metal scouring pads or abrasive cleansers. They will damage the non-stick coating on the griddle.
- Lightly wipe with cooking oil to season. You don't have to grease the griddle every time you use it.
 - DO NOT** use shortening or butter to season the griddle.
- Preheat on HI, then turn control to a lower setting to cook.
- Add food. **Use only nylon or plastic utensils.** Metal can scratch the non-stick coating.
- Turn off** the burners when cooking is finished. Leaving them ON can damage the griddle.

Approximate minimum griddle cooking times

Both burners must be ON to get proper cooking results. Preheat on HIGH, then turn to a lower setting to cook.

Food	Preheat Time	Cook Setting	Approximate Cooking Time	
			Side 1	Side 2
Bacon	No Preheat	MED	3 Min.	3 Min.
Pancakes	3 Min.	MED	1½ Min.	1 Min.
Pork Sausage Patty	No Preheat	MED	4 Min.	3½ Min.
Eggs	No Preheat	MED	1½ Min.	1 Min.
Grilled Sandwich	3 Min.	MED	3 Min.	3 Min.
French Toast	3 Min.	MED	3 Min.	3 Min.

Using the rotisserie

NOTE: Make sure the grill controls are OFF, and the grill is cool before installing the rotisserie.

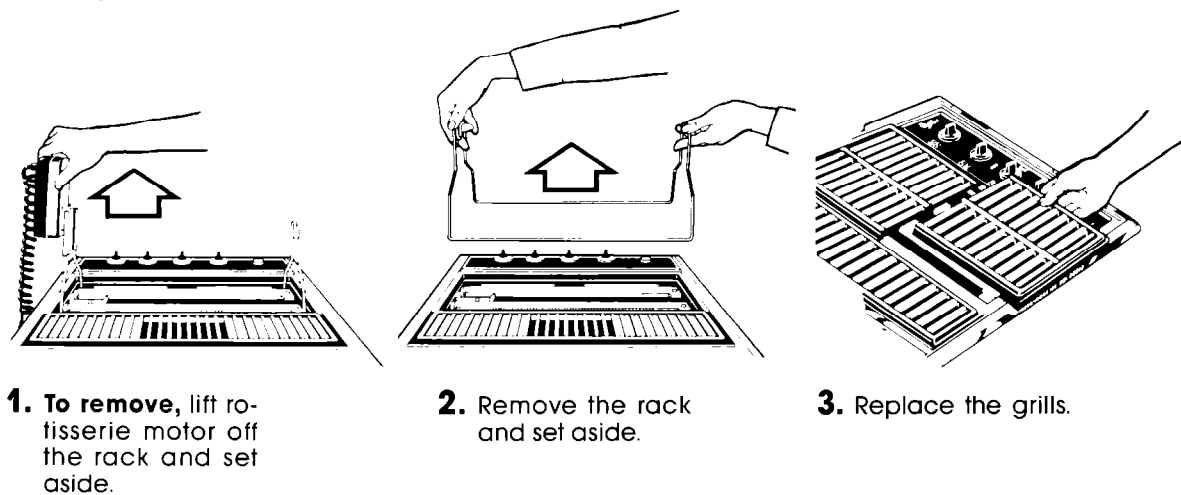
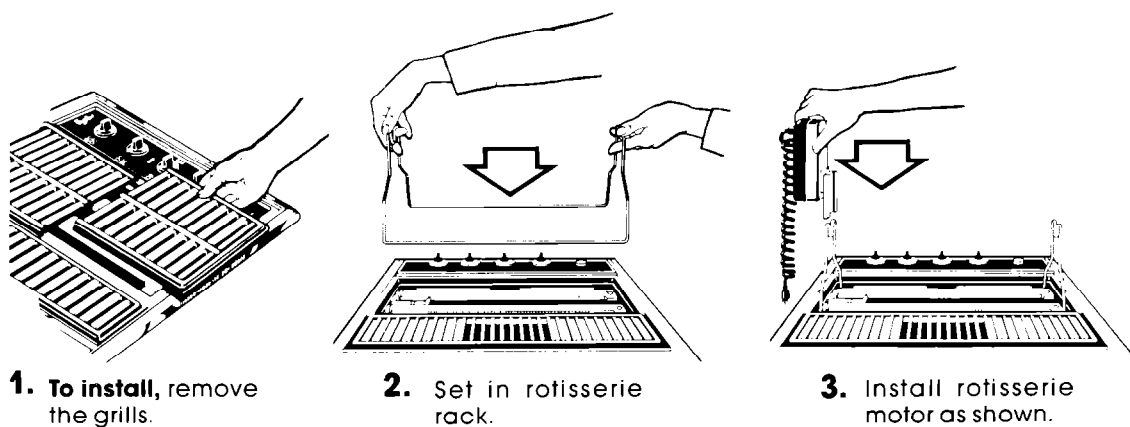
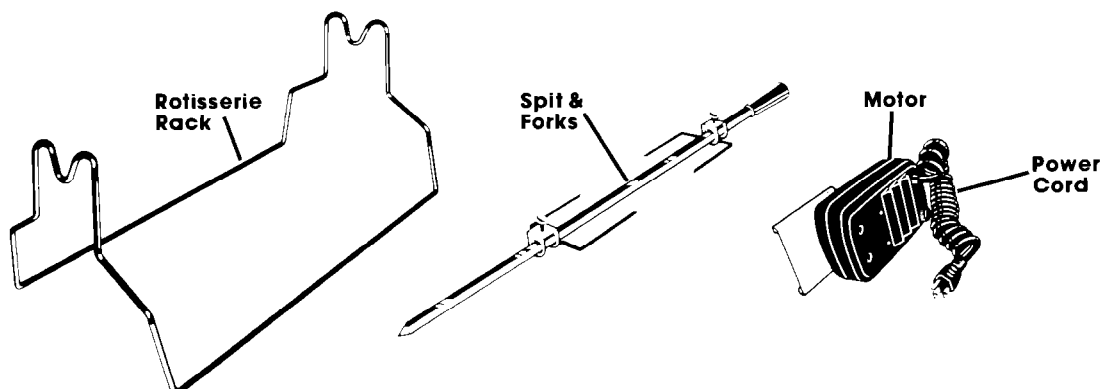

To put meat on spit

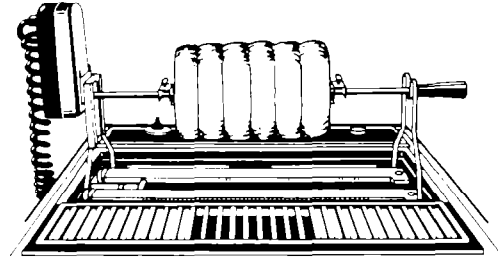
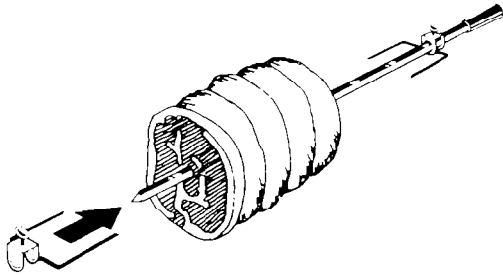

1. Put fork on the spit pointing away from the handle.
2. Push spit through meat so the weight is balanced around the center.
3. Put the second fork on the spit pointing toward the meat.
4. Push both forks into the meat and tighten the thumbscrews.
5. Push the pointed end of the spit all the way into the motor socket.
6. Put the handle end of the spit into the rack slot.
7. Plug in and turn on the rotisserie motor. Turn on the Grill Module. See below for suggested cooking times.

Approximate minimum rotisserie cooking times

No preheat required.

The individual burner controls help provide extra heat control. HI/MED combination settings can be used for best cooking results.

Food	Control Settings		Minutes / Pound	Internal Temperature
	Right Burner	Left Burner		
Beef Roast				
Well-done	HI	MED	45	170 F
Pork Loin Roast	HI	MED	65	185 F
Leg of Lamb	HI	MED	45	180 F
Chicken, med.	HI	MED	120 Total	190 F
Cornish Game Hen	HI	MED	60 Total	190 F

Be sure grills are removed during rotissing.

Roasts of approximately 3-3½ pounds are the most suitable for rotissing. Larger roasts will greatly increase cooking times.

Cleaning and caring for your cooktop

Control panel and knobs

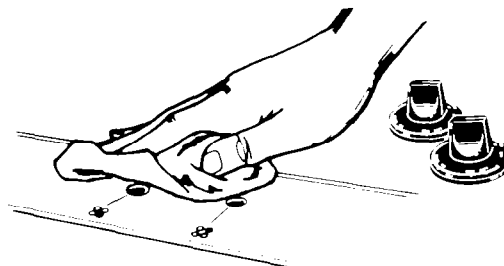
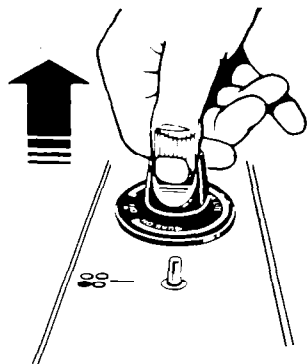

1. First make sure knobs are set on OFF, then pull knob straight off.
2. Lift off the control panel.
3. Use warm soapy water and a soft cloth to wipe the panel. Rinse and wipe dry.

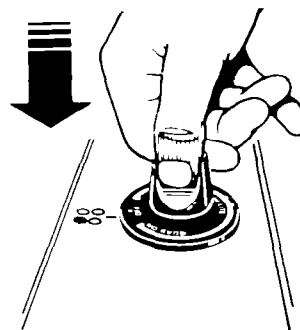
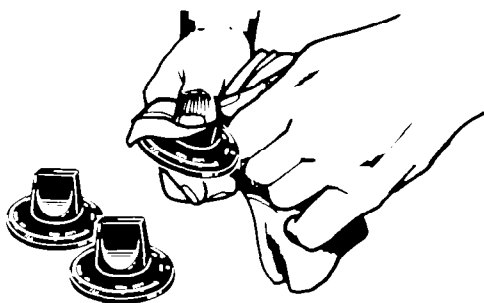

4. Wash knobs in warm soapy water. Rinse well and dry.
5. Replace the control panel.
6. Push the knobs straight back on. Make sure they point to OFF.

Burners

Occasionally check the burner flames for proper size and shape as shown below. If flames do not burn properly, you may need to clean the burners (see page 13), or call a qualified technician for adjustment.

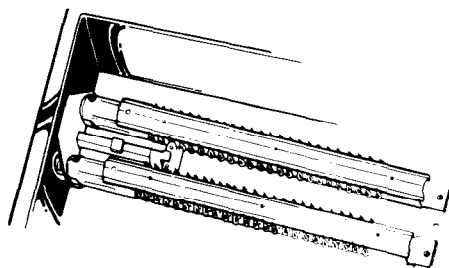

TYPICAL GRILL BURNER FLAME

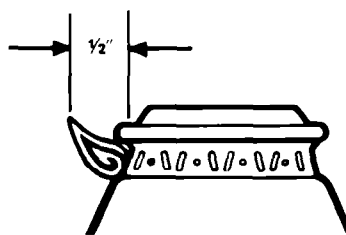

TYPICAL TOP BURNER FLAME

Cleaning cooktop modules

Make sure all controls are OFF and the cooktop parts are cool before cleaning.

PART	WHAT TO USE	HOW TO CLEAN
Surface Burner Module	Grates Warm soapy water or a dishwasher	<ul style="list-style-type: none"> • Wash, rinse and dry well. • Use scouring pads for stubborn areas.
	Cover Warm soapy water or a dishwasher.	<ul style="list-style-type: none"> • Clean often. • Wash, rinse and dry well. • Do not use metal scouring pads or harsh cleansers.
	Burners with Burner Pan Remove cover: To remove the cover from the module. Remove module from cooktop, then push in buttons on the sides while lifting the cover at the same time. Warm soapy water and a soft cloth. Do not put surface burner pan in dishwasher.	<ul style="list-style-type: none"> • Do not put in water. • Wipe clean with a damp, soft cloth. If ports are clogged, clean with a straight pin. Do not enlarge or distort the ports.
Grill Module	All grill module parts Hot soapy water or a dishwasher.	<ul style="list-style-type: none"> • Wash, rinse and dry well. • Do not use metal scouring pads or harsh cleansers. • Use a soft brush or plastic scouring pad for stubborn areas. <p>If turned on soon after washing, a popping sound may occur until the moisture inside the burner dries.</p>
Griddle	Warm soapy water.	<ul style="list-style-type: none"> • Clean after each use. • Wash, rinse and dry well. • Do not use metal scouring pads or harsh cleansers. • Use plastic scouring pads, if needed.
Rotisserie	Rack and Spit Warm soapy water and plastic scouring pad.	<ul style="list-style-type: none"> • Wash, rinse and dry well. • Clean after each use.
	Motor Soft cloth; warm soapy water.	<ul style="list-style-type: none"> • Do not put in water. • Unplug before cleaning. • Wipe clean after each use.
Vent System	Cover Warm soapy water or a dishwasher.	<ul style="list-style-type: none"> • Wash, rinse and dry well. • Clean often.
	Filters Hot soapy water or a dishwasher.	<ul style="list-style-type: none"> • Wash, rinse and dry well. • Clean often.
	Vent Box Warm soapy water and a cloth or sponge.	<ul style="list-style-type: none"> • Wipe out grease residue with a cloth. Sponge out spills. • Clean often.

Under normal use the blower requires no oiling for the first year. After the first year, oil every three months with SAE 20 oil.



WARNING:
DO NOT USE OVEN CLEANERS, BLEACH OR RUST REMOVERS.
FOR YOUR SAFETY, DO NOT USE GASOLINE OR OTHER FLAMMABLE LIQUIDS OR VAPORS TO CLEAN THIS OR ANY OTHER APPLIANCE.

Cleaning the vent system



WARNING – Be sure fan is OFF before cleaning the vent system. Do not put hand in vent box if fan is moving.

Before cleaning the vent system, turn the fan OFF.

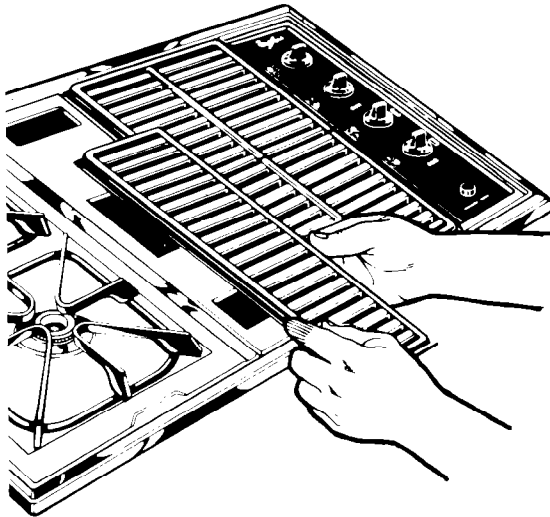

1. To clean, remove vent cover and wipe clean with damp cloth or wash in warm soapy water. Do not use metal scouring pads or harsh cleansers.

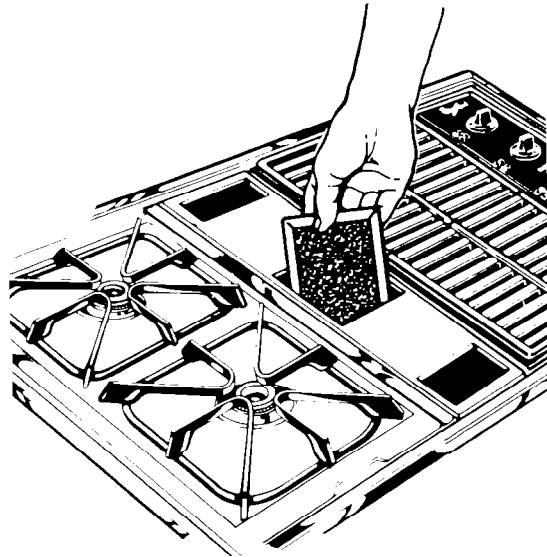

2. Lift filter and turn slightly to remove. They can be cleaned in hot soapy water or in a dishwasher.

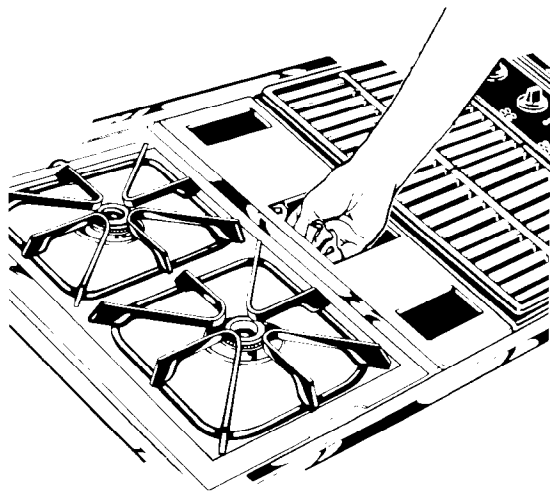

3. Be sure fan is turned OFF. Wipe the vent box with a damp cloth to clean. Spills should be sponged out.

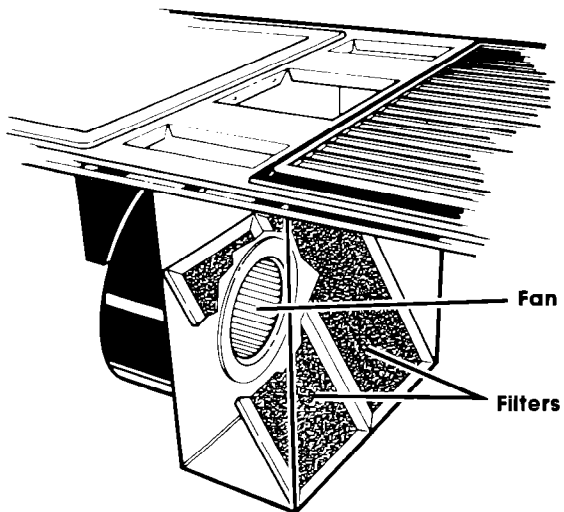

4. Install filters, being sure they are angled over the exhaust fan and touching at the center. Filters must be in place for safe proper operation.

Replacement filters can be ordered from a Whirlpool Dealer or TECH-CARE® Service Company. Order part number 786220 (one pair).

If you need service or assistance, we suggest you follow these four steps:

1. Before calling for assistance...

Performance problems often result from little things you can find and fix yourself without tools of any kind.

If nothing operates:

- Is the cooktop properly connected to gas and electrical supplies? (See Installation Instructions.)
- Have you checked the main fuse or circuit breaker box?
- Is the flow of combustion and/or ventilation air to the unit obstructed? **Do not obstruct air flow to and around the unit.**

If burner fails to light:

- Is the unit connected to electrical power?
- Have you checked the main fuse or circuit breaker box?
- Are burner ports clogged? (See page 13.)

If burner flames are uneven:

- Are burner ports clogged? (See page 13.)

If burner flames lift off ports, are yellow, or are noisy when turned off:

- The air/gas mixture may be incorrect. (Call for service.)

If burners make a popping noise when ON:

- Is the burner wet from washing? Let dry.

If a control knob or knobs will not turn:

- Did you push in before trying to turn?

If cooking results aren't what you expected: Surface burners

- Is the cooktop level?
- Are the pans the size called for in the recipe?
- Does the flame size fit the cooking utensil being used? (See page 6.)

Grill

- Did you leave space between the food items?
- Was the grill preheated for the proper amount of time?
- Was food partially frozen or very cold before grilling? Cooking time will be longer.

If venting results aren't what you expected:

- Is the exhaust fan turned ON?
- Are the cooktop surface burners and module parts clean? They must be cleaned after each use.
- Are the vent filters clean and in place?
- Is the vent duct or outside opening blocked?
- Is there a draft in the room where the cooktop is installed?
- Has the meat fat been well trimmed?

2. If you need assistance* ...

Call the Whirlpool COOL-LINE® service assistance telephone number. Dial free from:

Continental U.S. (800)253-1301
Michigan (800)632-2243
Alaska & Hawaii (800)253-1121

and talk with one of our trained Consultants. The Consultant can instruct you in how to obtain satisfactory operation from your appliance or, if service is necessary, recommend a qualified service company in your area.

3. If you need service* ...



Whirlpool has a nationwide network of franchised TECH-CARE® Service Companies. TECH-CARE service technicians are trained to fulfill the product warranty and provide

after-warranty service, anywhere in the United States. To locate TECH-CARE service in your area, call our COOL-LINE service assistance telephone number (see Step 2) or look in your telephone directory Yellow Pages under:

APPLIANCES - HOUSEHOLD - MAJOR - SERVICE & REPAIR	OR	ELECTRICAL APPLIANCES - MAJOR - REPAIRING & PARTS
WHIRLPOOL APPLIANCES FRANCHISED TECH-CARE SERVICE		WHIRLPOOL APPLIANCES FRANCHISED TECH-CARE SERVICE
SERVICE COMPANIES		
XYZ SERVICE CO 123 Maple 999-9999		XYZ SERVICE CO 123 Maple 999-9999
OR		
WASHING MACHINES, DRYERS & IRONERS - SERVICING		
WHIRLPOOL APPLIANCES FRANCHISED TECH-CARE SERVICE		
SERVICE COMPANIES		
XYZ SERVICE CO 123 Maple 999-9999		

4. If you have a problem* ...

Call our COOL-LINE service assistance telephone number (see Step 2) and talk with one of our Consultants, or if you prefer, write to:

Mr. Robert F. Gunts, Vice President
Whirlpool Corporation
Administrative Center
2000 US-33 North
Benton Harbor, MI 49022

*If you must call or write, please provide: model number, serial number, date of purchase, and a complete description of the problem. This information is needed in order to better respond to your request for assistance.



FSP is a registered trademark of Whirlpool Corporation for quality parts. Look for this symbol of quality whenever you need a replacement part for your Whirlpool appliance. FSP replacement parts will fit right and work right, because they are made to the same exacting specifications used to build every new Whirlpool appliance.



Making your world a little easier.

Part No. 63922/786105 Rev. A
©1984 Whirlpool Corporation

Printed in U.S.A.

se Makers, Dishwashers, Built-In Ovens and Surface Units, Ranges, Microwave Ovens, Trash Compactors, Room Air Conditioners, Dehumidifiers, Automatic Washers, Clothes C

