

use & care guide

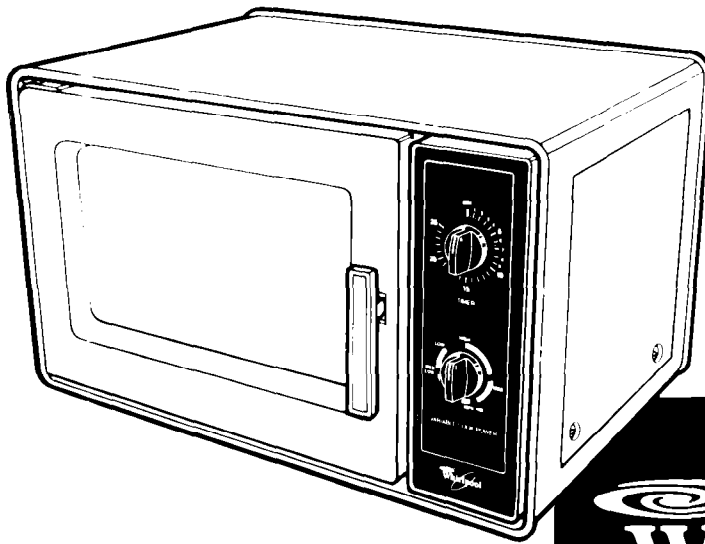

COMPACT MICROWAVE OVEN



Model MW3200XM

s. Freezers, Refrigerator-Freezers, Ice Makers, Dishwashers, Built-In Ovens and Surface Units, Ranges, Microwave Ovens, Trash Compactors, Room Air Conditioners, Dehumidifi

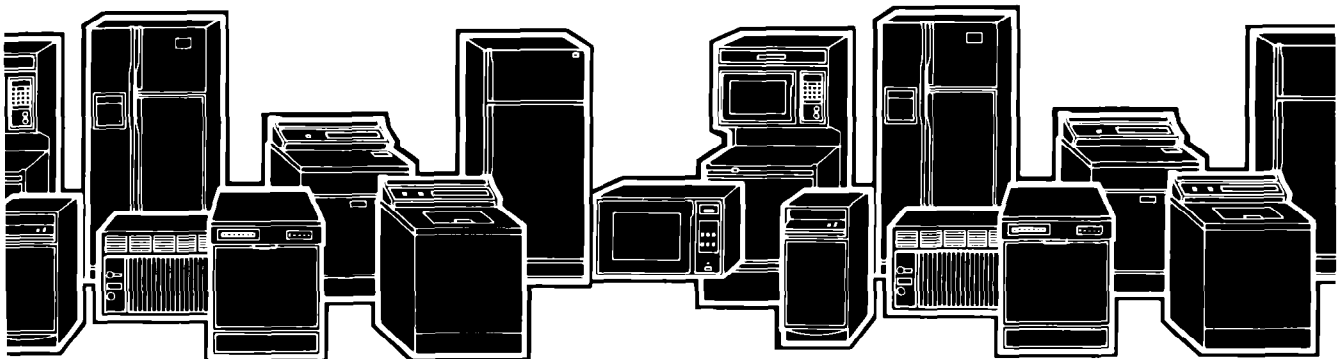

Contents

	Page		Page
Parts and Features	2	Setting the Controls	9
Important Safety Instructions	3	Caring for Your Microwave Oven	10
Before You Use Your Microwave Oven	4	Cleaning the Microwave Oven	10
Precautions to Avoid Possible		Replacing the Light Bulb	10
Exposure to Excessive		Building In Your Microwave Oven	10
Microwave Energy	4	If You Need Service or Assistance	11
Operating Safety Precautions	4	1. Before Calling for Assistance	11
Installation Instructions	6	2. If You Need Assistance	11
Using Your Microwave Oven	8	3. If You Need Service	11
Microwave Oven Controls	8	4. If You Have a Problem	11
Cooking in Your Microwave Oven	8		

©1984 Whirlpool Corporation

Parts and features

Model MW3200XM

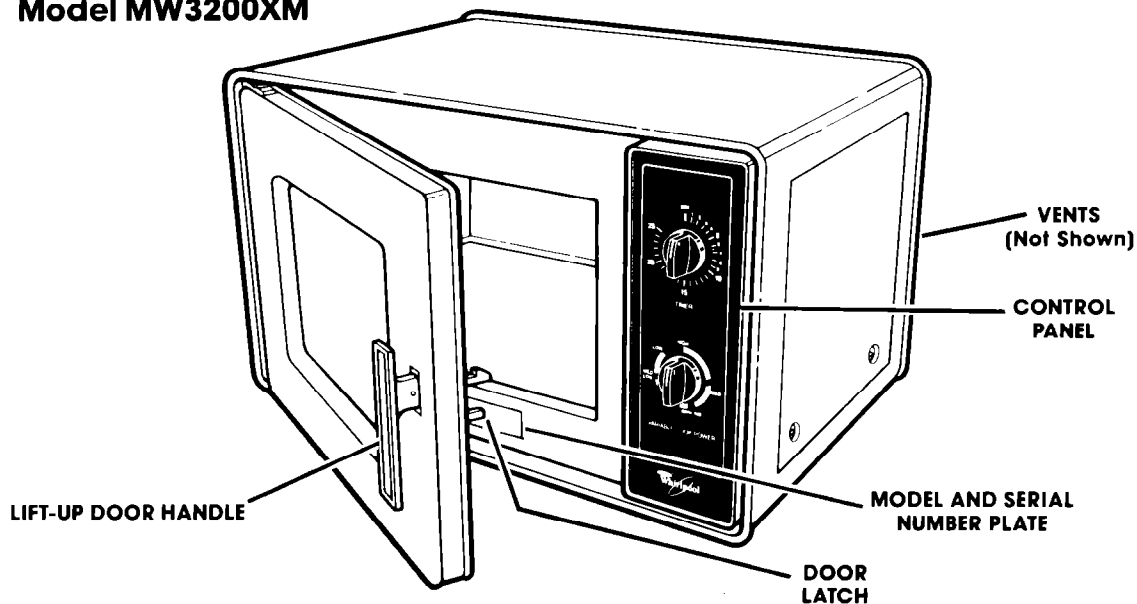

Copy your Model and Serial Numbers here...

If you need service or call with a question, have this information ready.

1. **Complete** Model and Serial Numbers (from the plate behind the microwave oven door on the lower oven frame).

2. Purchase date from sales slip.

Copy this information in these spaces. Keep this book, your warranty and sales slip together in a handy place. There is no warranty registration to return. Proof-of-purchase is all that is required for in-warranty service.

Model Number

Serial Number

Purchase Date

Service Company Phone Number

Fill out and return the "Microwave Registration Card" inside the oven. If the card is missing, please send the model number of your microwave oven, with your name and address to...

Whirlpool Corporation
Microwave Registration Department
Administrative Center
2000 U.S. 33 North
Benton Harbor, Michigan 49022

This information will help us reach you if there is ever a need to pass along information about your microwave oven.

IMPORTANT SAFETY INSTRUCTIONS

When using electrical appliances basic safety precautions should be followed, including the following:



WARNING – To reduce the risk of burns, electric shock, fire, injury to persons or exposure to excessive microwave energy:

1. Read all instructions before using appliance.
2. Read and follow the specific "PRECAUTIONS TO AVOID POSSIBLE EXPOSURE TO EXCESSIVE MICROWAVE ENERGY" found on page 4
3. This appliance must be grounded. Connect only to properly grounded outlet. See "GROUNDING INSTRUCTIONS" found on page 7
4. Install or locate this appliance only in accordance with the provided installation instructions.
5. Some products such as whole eggs and sealed containers – for example, closed glass jars – may explode and should not be heated in this oven.
6. Use this appliance only for its intended use as described in this manual.
7. As with any appliance, close supervision is necessary when used by children.
8. Do not operate this appliance if it has a damaged cord or plug, if it is not working properly, or if it has been damaged or dropped. Electric shock, fire or other hazards may result.
9. This appliance should be serviced only by qualified service personnel. Call a Whirlpool authorized TECH-CARE® Service Company for examination, repair or adjustment.
10. Do not cover or block any opening on the appliance for fire may result.
11. Do not use outdoors for damage to the oven or electric shock may result.
12. Do not immerse cord or plug in water for electric shock may result.
13. Keep cord away from heated surfaces for electric shock may result.
14. Do not let cord hang over edge of table or counter for electric shock may result.
15. See door surface cleaning instructions on page 10.
16. To reduce the risk of fire in the oven cavity:
 - a. Do not overcook food. Carefully attend appliance if paper, plastic, or other combustible materials are placed inside the oven to facilitate cooking. Paper can char or burn, and some plastics can melt if used when heating foods for more than 4 minutes.
 - b. Remove wire twist-ties from paper or plastic bags before placing bag in oven. Cooking in metal containers can damage the oven. So can containers with hidden metal (twist-ties, foil-lining, staples, metallic glaze or trim). Test dinnerware or cookware before using. See page 4.
 - c. If materials inside the oven should ignite, keep oven door closed, turn oven off, and disconnect the power cord, or shut off power at the fuse or circuit breaker panel.

SAVE THESE INSTRUCTIONS

Before you use your microwave oven



Read this "Use and Care Guide" carefully for important use and safety information.

It is your personal responsibility and obligation to be sure your microwave oven:

- Has been installed where it is protected from the elements. **The microwave oven should be at a temperature above 50°F (10°C) for proper operation.**
- Has been installed on a surface strong enough to support its weight.
- Has been properly connected to electrical supply and grounded.*
- Is not used by children or anyone unable to operate it properly.
- Is properly maintained.
- Is used only for jobs expected of a home microwave oven.

*See installation instructions on page 6.

PRECAUTIONS TO AVOID POSSIBLE EXPOSURE TO EXCESSIVE MICROWAVE ENERGY...

DO NOT attempt to operate this oven with the door open since open-door operation can result in harmful exposure to microwave energy. It is important not to defeat or tamper with the safety interlocks

DO NOT place any object between the oven front face and the door or allow soil or cleaner residue to accumulate on sealing surfaces

DO NOT operate the oven if it is damaged. It is particularly important that the oven door close properly and that there is no damage to the

- (1) Door (bent).
- (2) Hinges and latches (broken or loosened),
- (3) Door seals and sealing surfaces.

DO NOT operate the microwave oven with the service panel removed.

The microwave oven should be checked for microwave leakage by qualified service personnel after a repair is made.

The oven should not be adjusted or repaired by anyone except properly qualified service personnel.

Operating safety precautions

DO NOT use the oven until you have read and understand **ALL** the information on safe use.

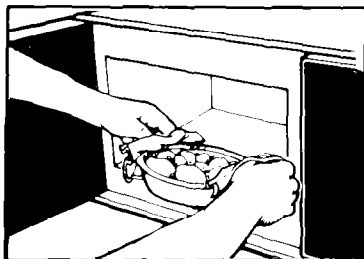

USE HOT PADS. Microwave energy does not heat containers, but the hot food does.

DO NOT let the oven continue to operate after removing food. Turn Timer Knob counter-clockwise to "0"

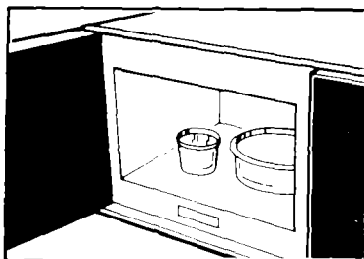

To test a dish for safe use, put it into the oven with a cup of water **beside it**. Cook on high Cook Power for one minute. **If the dish gets hot and water stays cool do not use it.**

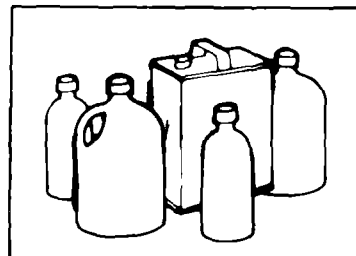

DO NOT heat or store flammable or inflammable materials in or near the oven.

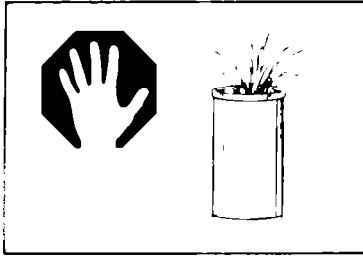

WARNING – Use care when heating liquids or adding ingredients to heated liquids. Liquids heated in certain shaped containers may become overheated. The liquid may splash out with a loud noise during or after heating or when adding ingredients (instant coffee, etc.). This can harm the oven and the hot liquid could burn you. Do not use such containers to heat liquids again.

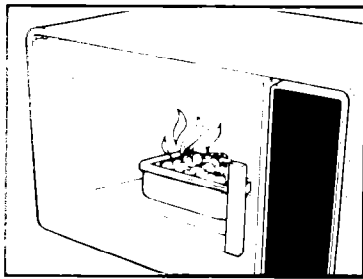

If a fire should start in the oven cavity:

- **keep door closed**
- **turn oven off**
- **disconnect the power supply** at the cord, fuse or circuit breaker.

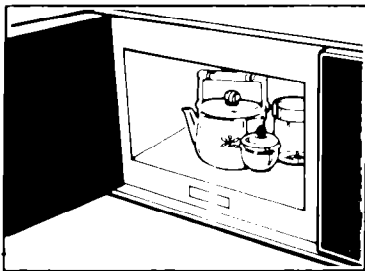

DO NOT use the oven for storage. Do not leave paper products, books or cooking utensils in the oven when not in use. Fire may result if someone accidentally starts the oven.

Don't let anything touch the top of the oven.

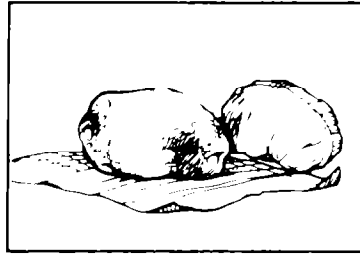

DO NOT OVERCOOK POTATOES. Fire could result. At the end of the recommended cooking time they should be slightly firm. Wrap in foil and set aside for 5 minutes. They will finish cooking while standing.

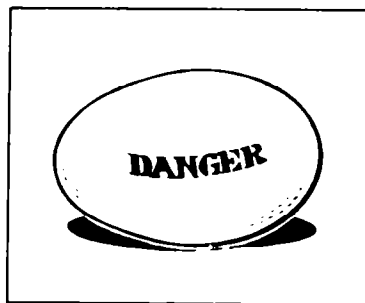

NEVER COOK OR REHEAT A WHOLE EGG. Steam build-up in whole eggs may cause them to burst and burn you, and possibly damage the oven. Slice hard boiled eggs before heating. In rare instances, poached eggs have been known to explode. Cover poached eggs and allow a standing time of one minute before cutting into them.

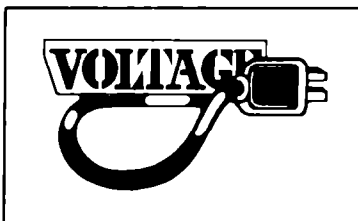

If your electric power line voltage is less than the normal 120 volts, cooking times may be longer.

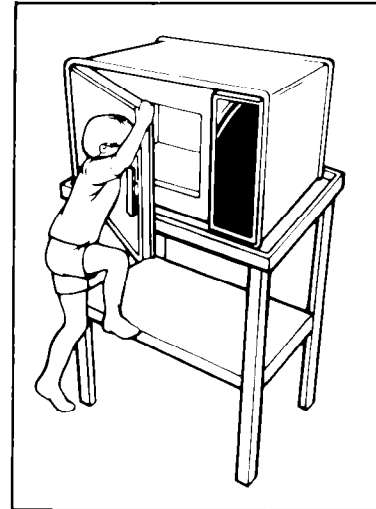

NEVER lean on the door or allow a child to swing on it when the door is open. Injury could result.

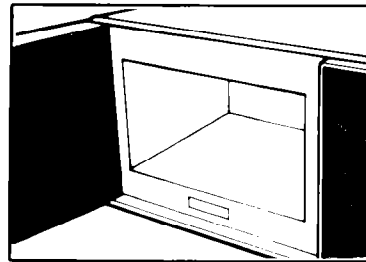

NEVER start a microwave oven when it's empty. The oven can be damaged. If you experiment, put a container of water in the oven. It is normal for the inside of the oven door to look wavy after the oven has been running for a while.

Installation instructions

BEFORE YOU BEGIN, READ THE FOLLOWING INSTRUCTIONS COMPLETELY AND CAREFULLY.

Installing your microwave oven

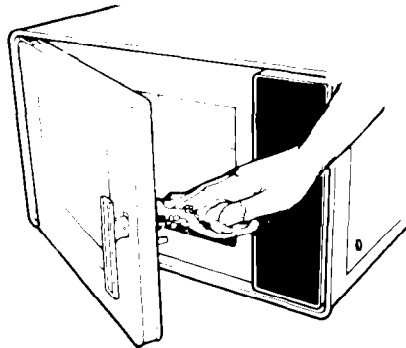

1. Empty the microwave oven and clean inside it with a soft, damp cloth. Check for damage such as misaligned door, damage around the door or dents inside the oven or on the exterior. If there is any damage, please do not operate the unit until it has been checked by an authorized Whirlpool service technician and any repairs made.

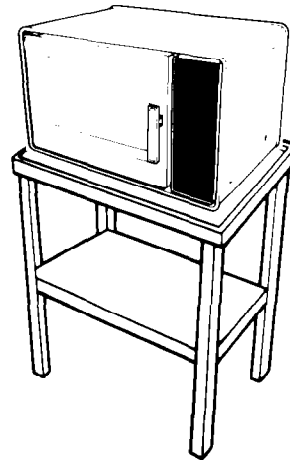

2. Put the oven on a cart, counter, table or shelf that is strong enough to hold the oven and the food and utensils you put in it. **(The control side of the unit is the heavy side. Handling can be tricky.)** The weight of the oven is approximately 41 lbs. (18.6 kg).

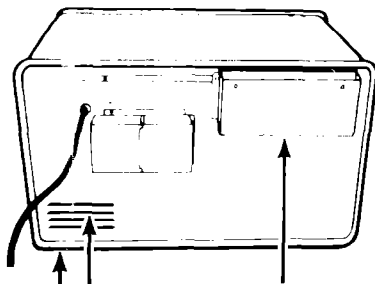

3. Do not block the vent or air intake openings on the rear of the oven. Blocking vent or air intake openings can cause damage to the oven and poor cooking results. Make sure the microwave oven legs are in place to ensure proper air flow.

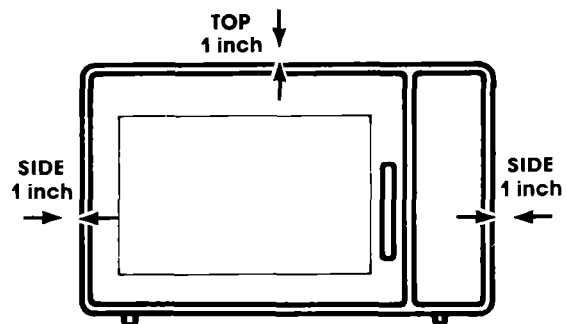

4. Do not install the microwave oven so that both sides and the top are flush with walls, shelves or cabinets. Both sides and the top must have at least 1 in. (2.54 cm) clearance for proper operation.

Do not install the oven next to or over a conventional surface unit or in any area where excessive heat and steam are generated. This could damage the outside of the cabinet.

5. Read and follow the **ELECTRICAL REQUIREMENTS** and **GROUNDING INSTRUCTIONS** before plugging in and operating the microwave oven.

6. Electrical requirements

Observe all governing codes and ordinances.

A 120 Volt, 60 Hz, AC only, 15 Amp fused electrical supply is required. (Time-delay fuse is recommended.) It is recommended that a separate circuit serving only this appliance be provided.

DO NOT use a male to female extension cord.

7.

GROUNDING INSTRUCTIONS

Electrical ground is required on this appliance. **DO NOT, UNDER ANY CIRCUMSTANCES, REMOVE THE POWER SUPPLY CORD GROUND PRONG.**

8. Recommended grounding method

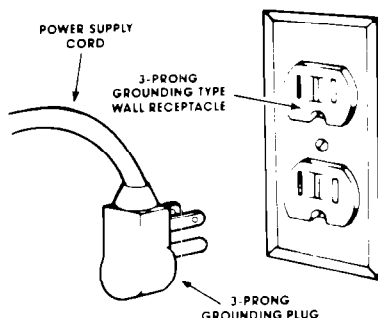

For your personal safety, this appliance must be grounded. This appliance is equipped with a power supply cord having a 3-prong grounding plug. To minimize possible shock hazard, the cord must be plugged into a mating 3-prong grounding type wall receptacle which is correctly polarized and grounded in accordance with the National Electrical Code and local codes and ordinances. If a mating wall receptacle is not available, it is the personal responsibility and obligation of the customer to have a properly polarized and grounded 3-prong wall receptacle installed by a qualified electrician.

9. Alternate grounding method

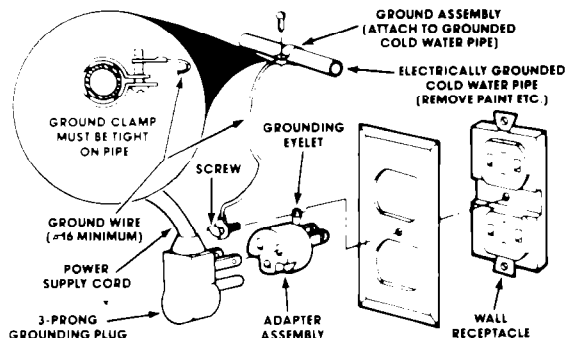

If changing and properly grounding the wall receptacle is impossible and where local codes permit (consult your electrical inspector), a temporary adapter may be plugged into the existing 2-prong wall receptacle to mate with the 3-prong power supply cord. **THIS, HOWEVER, IS NOT RECOMMENDED.**

If this is done, you must connect the grounding eyelet on the adapter to the wall receptacle coverplate screw and from this same screw, you must connect a separate copper ground wire (No. 16 minimum) to a grounded cold water pipe.*

Do not ground to a gas supply pipe. Do not connect to electrical supply until appliance is permanently grounded.

*Cold water pipe must have metal continuity to electrical ground and not be interrupted by plastic, rubber or other electrically insulating connectors (including water meter or pump) without adding a jumper wire at these connections.



10. Plug the oven into the proper electrical outlet and put about one cup (250 mL) of cold water in a glass container in the oven. Close the door. Make sure it latches. Follow the directions on page 9 to set the oven to COOK for 2 minutes. When the time is up, the water should be heated.

11. This microwave oven is designed for use in the household only and must not be used for commercial purposes.

DO NOT remove the service panel, door, or control panel at any time. The unit is equipped with high voltage and should not be serviced unless by an authorized Whirlpool trained service technician.

Using your microwave oven

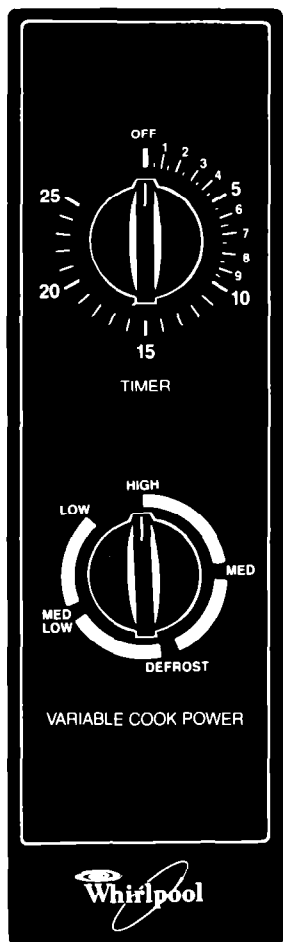

Microwave oven controls

There are two parts in the control section:

- The Timer
- The Cook Power Selector

What each of these do will be covered on the following pages. Read them carefully.

The Timer

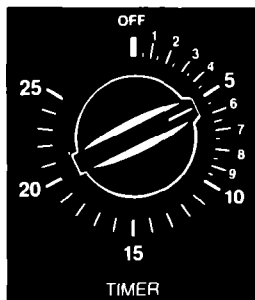

The minute timer can be set for up to 25 minutes. This controls how long the microwave oven cooks.

The Cook Power Selector

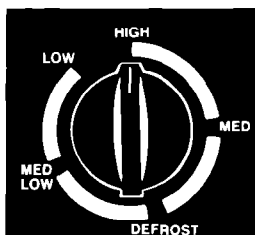

The Cook Power Selector allows you to choose the Cook Power setting that best meets your cooking needs. See the Cook Power Chart on page 9 for the different percentages of cooking powers.

Cooking in your microwave oven

Be sure to read the **Cooking Guide** packed with your microwave oven. It contains information about:

- What microwave energy is
- How food is cooked by microwave energy
- What affects cooking speed and cooking evenness
- Safety tips
- Utensils to use when cooking in the microwave oven
- Cooking times for different foods

Important things to remember to get the best cooking results.

- ALWAYS cook food for the minimum recommended cooking time. If necessary, add time in one or two minute periods, then check for doneness to avoid overcooking the food.
- Stir, turn or rearrange the food about halfway through the cooking time for most even doneness with all recipes.
- If a glass cover is not available, use waxpaper, paper towels or Saran® Wrap. Turn back a corner to vent steam during cooking.
- When using microwave recipes from other cookbooks or sources, slightly longer cooking times will be needed for those recipes calling for "HIGH" or "FULL" cook power. For example, add 1 to 2 minutes to a 5 minute cooking time. Cooking times at settings less than "HIGH" (such as "MEDIUM") would not need any adjustment.

Setting the controls

Be sure you understand the basics of microwave oven cooking before you begin. Start with the instructions in the Cooking Guide. Follow the directions carefully.

DO THIS...

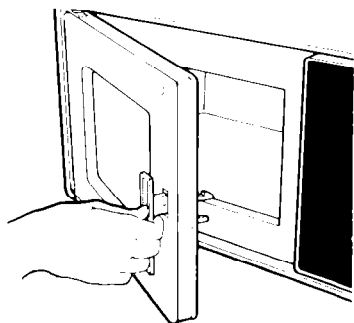

1. Open the oven door by lifting the door handle.

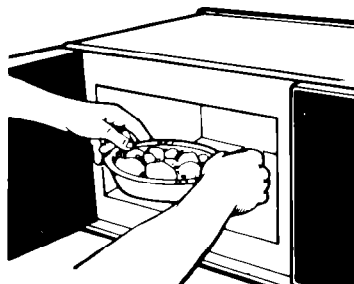

2. Put food in the oven. **DO NOT CLOSE THE DOOR.**

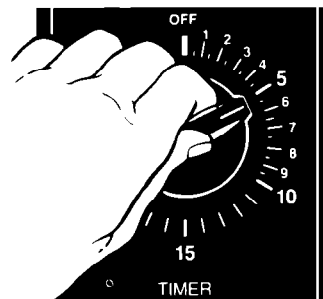

3. Set the cooking time by turning the Timer Knob clockwise. To reduce the cooking time, turn the Timer Knob counterclockwise.
To set timer for less than 1 minute, turn timer past 1 minute then to desired time.

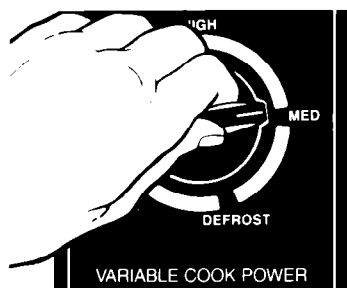

4. Set the Cook Power to the desired setting from HIGH to LOW. For best results, some recipes call for lower Cook Powers. (See chart below.) The lower the Cook Power, the slower the cooking.

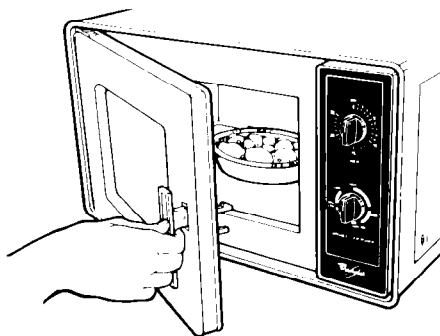

5. Close the door. The oven will start cooking and the oven light will come on. You will hear a fan running during oven operation.

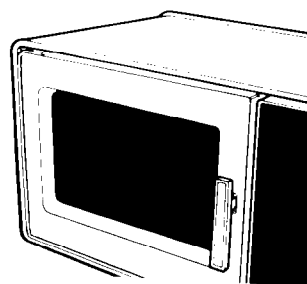

6. When the set time is up, the oven will shut off automatically. The light will go off and the fan will stop.

COOK POWER CHART

Recipes in the Cooking Guide use Cook Power settings from HIGH to LOW. Recipes from other books and magazines may use different Cook Power percentages. The following chart may be helpful:

HIGH – 100% of full power
MED – 70% of full power
DEFROST – 50% of full power
MED-LOW – 30% of full power
LOW – 15% of full power

To stop the oven

1. Turn Timer Knob counterclockwise to "0."
- OR
2. Open the oven door. Opening the oven door stops the oven so you can stir, turn, rearrange or add ingredients to the food. Close the oven door to complete cooking. If you remove the food, set the timer to "0" before closing the oven door so it will not operate.

Defrosting in your microwave oven

Use the DEFROST setting to thaw frozen food before cooking. This setting cooks at 50% of full power. For suggested defrost times, see the chart in the **Cooking Guide**.

Caring for your microwave oven

Cleaning the microwave oven



Wipe often with warm sudsy water and a soft cloth or sponge.

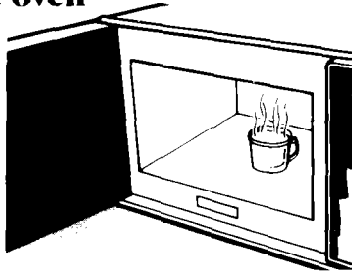

For stubborn soil, boil a cup of water in the oven for 2 or 3 minutes. Steam will soften the soil.

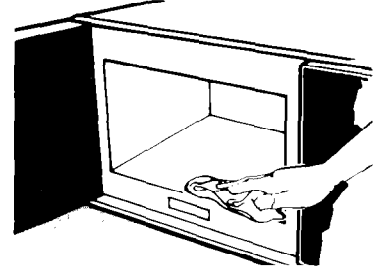

Be sure to clean the areas where the door and oven frame touch when closed. When cleaning surfaces of door and oven that come together on closing the door, use only mild, non-abrasive soaps or detergents applied with a sponge or soft cloth. Rinse well.

Caution:

Abrasive cleansers, steel wool pads, gritty wash cloths, etc. can damage the control panel and the interior and exterior oven surfaces. Use a soft cloth or a sponge with a mild detergent or spray glass cleaner.

Replacing the light bulb

1. Unplug the power cord.
2. Unsnap and remove the light cover by squeezing the top and bottom while pulling.
3. Remove the light bulb from its socket.
4. Replace with a 25-watt, T-8 candelabra base bulb.
5. Replace the light cover.
6. Plug in the power cord.

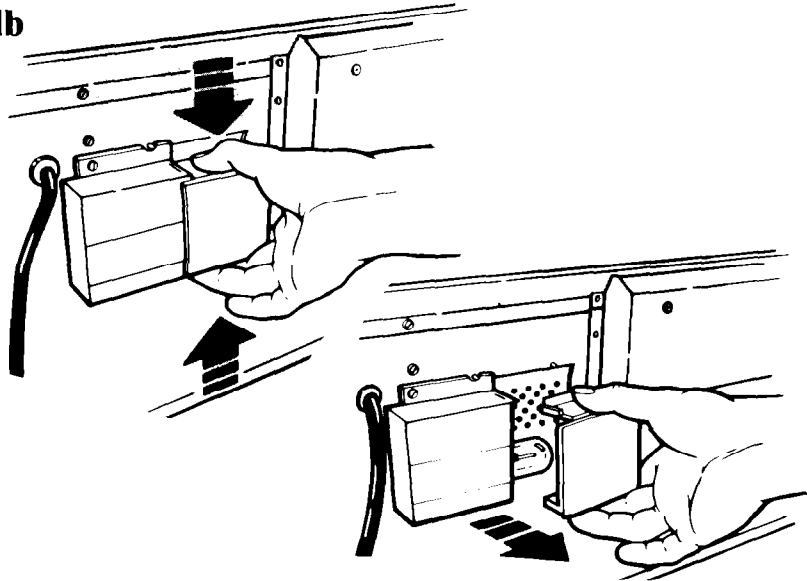

Building in your microwave oven

Your microwave oven is not limited to carts, counters or tables. Custom installations are made easy with kits available from your dealer.

1. Build the microwave oven into a cabinet or a wall.
2. Attach the microwave oven to a wall by itself or with cabinets over it.

Ask your dealer for details on...

- RCK304 (788002) – 24-inch Built-in Kit
- RCK310 (788004) – Wall Mount Kit

If you need service or assistance, we suggest you follow these four steps:

1. Before calling for assistance...

Performance problems often result from little things you can find and fix yourself without tools of any kind.

If nothing operates:

- Is the oven correctly plugged into a live circuit with the proper voltage? (See page 6.)
- Have you checked the main fuse or circuit breaker box?

If the microwave oven will not run:

- Is the timer set?
- Is the door firmly closed and latched?
- Did you follow the directions exactly?

If microwave cooking times seem too long:

- Is the electric supply to your home low or lower than normal? Your electric company can tell you if the line voltage is low.
- Is the Cook Power at the recommended setting?
- Are you cooking more than one food item? More time will be needed.

2. If you need assistance*...

Call the Whirlpool COOL-LINE[®] service assistance telephone number. Dial free from:

Continental U.S. (800) 253-1301

Michigan (800) 632-2243

Alaska & Hawaii (800) 253-1121

and talk with one of our trained Consultants. The Consultant can instruct you on how to obtain satisfactory operation from your appliance or, if service is necessary, recommend a qualified service company in your area



FSP is a registered trademark of Whirlpool Corporation for quality parts. Look for this symbol of quality whenever you need a replacement part for your Whirlpool appliance. FSP replacement parts

will fit right and work right, because they are made to the same exacting specifications used to build every new Whirlpool appliance

3. If you need service*...



Whirlpool has a nationwide network of franchised TECH-CARE[®] service Companies. TECH-CARE service technicians are trained to fulfill the product warranty and provide after-

warranty service, anywhere in the United States. To locate TECH-CARE service in your area, call our COOL-LINE service assistance telephone number (see Step 2) or look in your telephone directory Yellow Pages under:

APPLIANCES - HOUSEHOLD- MAJOR - SERVICE & REPAIR	OR	ELECTRICAL APPLIANCES MAJOR REPAIRING & PARTS
WHIRLPOOL APPLIANCES FRANCHISED TECH-CARE SERVICE		WHIRLPOOL APPLIANCES FRANCHISED TECH-CARE SERVICE
SERVICE COMPANIES		
XYZ SERVICE CO. 123 Maple 999 9999		XYZ SERVICE CO. 123 Maple 999 9999
OR		
WASHING MACHINES, DRYERS & IRONERS - SERVICING		
WHIRLPOOL APPLIANCES FRANCHISED TECH-CARE SERVICE		
SERVICE COMPANIES		
XYZ SERVICE CO. 123 Maple 999 9999		

4. If you have a problem*...

Call our COOL-LINE service assistance telephone number (see Step 2) and talk with one of our Consultants, or if you prefer, write to:

Mr. Guy Turner, Vice President
Whirlpool Corporation
Administrative Center
2000 U.S. 33 North
Benton Harbor, MI 49022

*If you must call or write, please provide: model number, serial number, date of purchase, and a complete description of the problem. This information is needed in order to better respond to your request for assistance.



Making your world a little easier.

Part No. 42283P01/788008
© 1984 Whirlpool Corporation

Printed in U.S.A.

Ice Makers, Dishwashers, Built-In Ovens and Surface Units, Ranges, Microwave Ovens, Trash Compactors, Room Air Conditioners, Dehumidifiers, Automatic Washers, Clothes D

