

How To Install Your *Gas Dryer*

(This dryer is set to operate on Natural Gas.)

Before you start, make sure that you have the following:

- New metal exhaust duct. Do Not use plastic duct. If you are using an existing duct system, remove any lint buildup (see Panel B, "Exhaust requirements").
- All the tools you will need and parts needed to connect gas supply to dryer. (see Panel A).
- The proper gas supply (see Panel A).
- A grounded 120-volt, 60-Hz, AC-only, 15- or 20-ampere fused electrical circuit (see Panel B, "Electrical requirements").
- Proper location (see Panel A and back cover).

**IMPORTANT:
Read and save
these instructions.**

IMPORTANT:

Installer: Leave Installation Instructions with the homeowner.

Homeowner: Keep Installation Instructions for future reference.

Save Installation Instructions for local electrical and gas inspector's use.

9/94

Before you start...

Check location where dryer will be installed. Proper installation is your responsibility. The dryer must not be installed or stored in an area where it will be exposed to water and/or weather. Make sure you have everything necessary for correct installation.

Proper gas and electric supply connections should be available.

Protection from the weather: Proper operation of dryer cycles requires temperatures above 45°F., or the dryer may not shut off when automatic cycles are used.

Four-inch metal exhaust duct is required.

Support: The floor must be able to support dryer weight of 175 pounds.

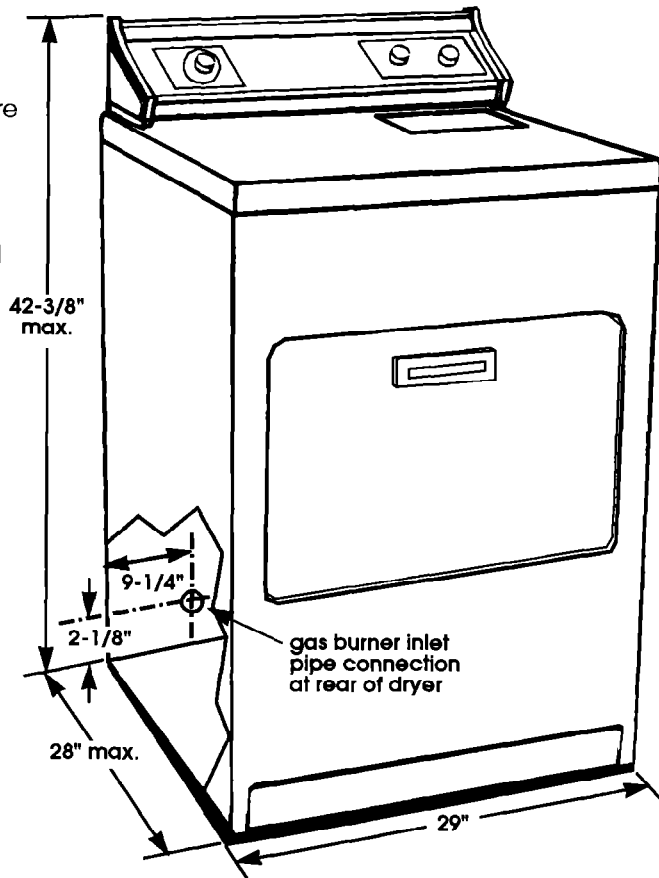

Important: Observe all governing codes and ordinances.

Check code requirements: Some codes limit or do not permit installation of clothes dryers in garages, closets, mobile homes, or sleeping quarters. Contact your local building inspector.

Open dryer and remove literature and parts packages.

Level floor: 1-inch maximum floor slope under entire dryer.

WARNING

Fire Hazard

For your safety the information in this manual must be followed to minimize the risk of fire or explosion or to prevent property damage, personal injury or loss of life.

- Do Not store or use gasoline or other flammable vapors and liquids in the vicinity of this or any other appliance.
- **WHAT TO DO IF YOU SMELL GAS**
- Do Not try to light any appliance.
- Do Not touch any electrical switch; Do Not use any phone in your building.
- Clear the room, building or area of all occupants.
- Immediately call your gas supplier from a neighbor's phone. Follow the gas supplier's instructions.
- If you cannot reach your gas supplier, call the fire department.
- Never install dryer up against draperies or curtains or on carpet.
- Keep any and all items from falling or collecting behind the dryer.

Installation and service must be performed by a qualified installer, service agency or the gas supplier.

Dryer Door Clearances

Location must be large enough to fully open dryer door. See back cover of Installation Instructions or label on dryer rear panel for recessed and closet requirements.

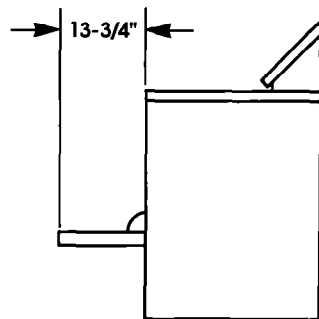

Extra-Large Hamper Door (shown above)

Mobile Home Installation

This appliance is suitable for mobile home installations. The installation of the dryer must conform to the Manufactured Home Construction and Safety Standard, Title 24 CFR, Part 3280 (formerly the Federal Standard for Mobile Home Construction and Safety, Title 24, HUD, Part 280).

For mobile home use, this appliance MUST be fastened to the floor and MUST be exhausted to the outside. Order Mobile Home Installation Kit No. 346765 from your dealer. Kit includes the necessary fastening hardware and detailed installation instructions. Metal exhaust system hardware is also available through your dealer.

This installation must conform with American National Standard, National Fuel Gas Code ANSI Z223.1 — latest edition, and all local codes and ordinances.

The design of this dryer has been certified by the American Gas Association for use at altitudes up to 10,000 feet above sea level at the B.T.U. rating indicated on the model/serial plate. Burner input adjustments are not required when the dryer is operated up to this elevation.

When installed above 10,000 feet, a four percent (4%) reduction of the burner B.T.U. rating shown on the model/serial plate is required for each 1,000 foot increase in elevation. For assistance when converting to other gas types and/or installing above 10,000 feet elevation, contact your local service company.

Tools and materials needed for installation:

metal exhaust duct
gas supply connection for 3/8" male pipe thread

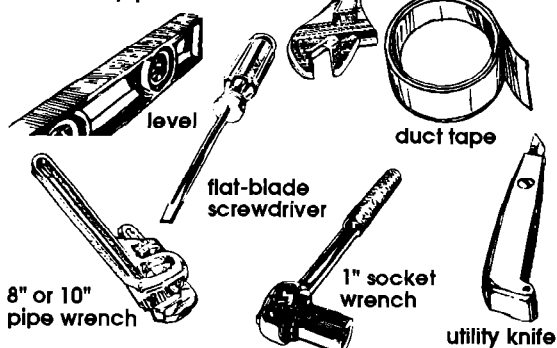

Panel A

Gas supply requirements

WARNING

Fire Hazard

- This dryer must be connected to a regulated gas supply. Failure to do so could cause high-pressure gas release, resulting in a fire or explosion.
 - Have the L.P. gas checked by a qualified person before installing the dryer. The L.P. gas supply must not exceed a pressure of 13" water column.
 - New flexible tubing should be used. Reusing old flexible tubing might result in possible leaks or fire hazard.
- Failure to follow these instructions may result in fire or explosion.

OBSERVE ALL GOVERNING CODES AND ORDINANCES.

A. Check that dryer is equipped with the correct burner for the particular type of gas in the home. Burner information will be found on the serial/rating plate in door well of the appliance. If this information does not agree with the type of gas available, see your dealer.

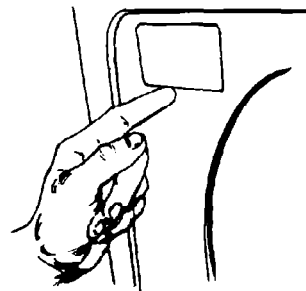

B. This dryer is equipped for use with NATURAL GAS. It is design-certified by A.G.A. for L.P. (propane or butane) gases with appropriate conversion. No attempt shall be made to convert the appliance from the gas specified on the serial/rating plate for use with a different gas without consulting the serving gas supplier. **Conversion must be done by a qualified service technician. Gas conversion kit part numbers are listed on the gas valve burner base.**

WARNING

Fire Hazard

If you install the dryer in a garage, carport, or areas near vehicles where fumes from gasoline or other flammable materials may be present, the vapors may be heavier than air and remain near floor. Place dryer a minimum of 18 inches above floor. Check with your building inspector regarding requirements for this installation.

Failure to follow these instructions could result in fire or explosion.

C. Provide a rigid gas supply line to the dryer location. When rigid pipe is used it should be 1/2 inch IPS. When acceptable to the gas supplier and local codes, 3/8-inch approved tubing may be used for lengths under 20 feet. For lengths over 20 feet, larger tubing should be used. Pipe-joint compounds resistant to the action of L.P. gas must be used.

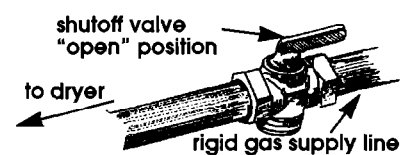

D. The supply line shall be equipped with a shutoff valve. This valve should be located in the same room as the dryer and should be in a location that allows the valve to be opened and closed easily. Do not block access to shutoff valve.

E. If the dryer is installed in a confined area such as a bedroom, bathroom or closet, provision must be made for enough air for combustion and ventilation. Check governing codes and ordinances. Also, check recessed and closet installation instructions section or label on dryer rear panel for detailed instructions.

F. If local codes permit, it is recommended that new flexible metal tubing, design-certified by the American Gas Association, be used for connecting the appliance to the rigid gas supply line. **(The gas pipe which extends through the lower rear of the appliance has 3/8-inch male pipe thread.)**

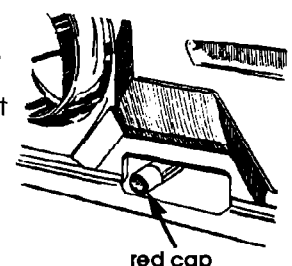

G. If rigid pipe is used as a gas supply line, a combination of pipe fittings must be used to obtain an in-line connection to the dryer.

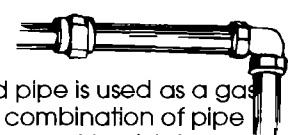

H. Make sure that lower edges of the cabinet, plus the back and bottom sides of the dryer are free of obstructions to permit adequate clearance of air openings for combustion air. See "Recessed and closet installation instructions," on the back cover, for minimum spacing requirements.

I. For ease of installation, operating and servicing (if ever needed) adequate space should be provided around the dryer.

J. A 1/8-inch NPT plugged tapping, accessible for test gauge connection, must be installed immediately upstream of the gas supply connection to the dryer. The dryer and its individual shutoff valve must be disconnected from the gas supply piping system during any pressure testing of that system.

K. If service is required, follow these instructions.

⚠ WARNING

Electrical Shock Hazard

- Disconnect from electrical supply before removing access panel.
 - Do not operate dryer without access panel securely in place.
- Failure to follow these instructions could result in electrical shock or death.

One-piece front panel

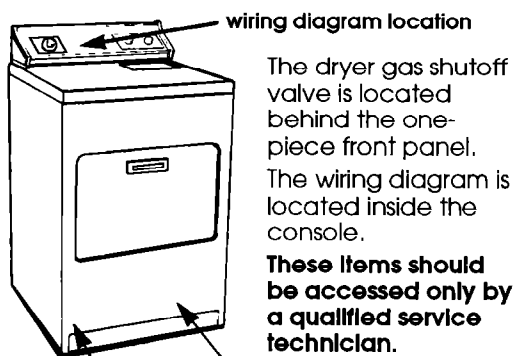

gas shutoff valve one-piece front panel

1. Disconnect electrical supply.
2. Remove lint screen and set aside.
3. Remove two screws from lint screen area.
4. Grasp front cabinet top corners and pull forward and up (top is hinged at rear).
5. Remove two screws from front panel flanges. Lift front panel off lower clips.
6. Remove door switch wires, if necessary, and set front panel aside.
7. Reassemble in reverse order.

Note: The door switch wires must not touch the drum.

Gas shutoff valve "open" and "closed" position

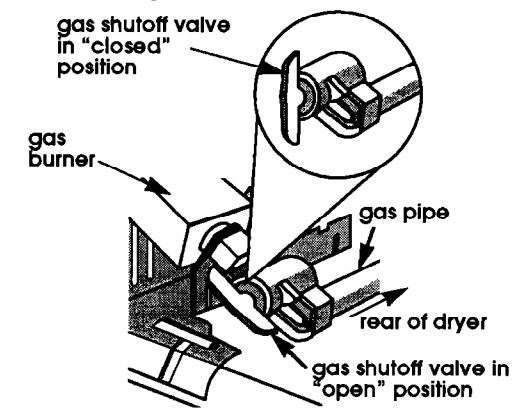

Electrical requirements

⚠ WARNING

Electrical Shock Hazard

- Electrical ground is required on this appliance.
- Do Not modify the power supply cord plug. If it does not fit the outlet, have a proper outlet installed by a qualified electrician.
- Do Not have a fuse in the neutral or grounding circuit. A fuse in the neutral or grounding circuit could result in an electrical shock.
- Do Not use an extension cord with this appliance.
- Check with a qualified electrician if you are in doubt as to whether the appliance is properly grounded.

Failure to follow these instructions could result in serious injury or death.

If codes permit and a separate grounding wire is used, it is recommended that a qualified electrician determine that the grounding path is adequate.

A 120-volt, 60-Hz, AC-only, 15- or 20-ampere fused electrical supply is required. Time-delay fuse or circuit breaker is recommended. It is recommended that a separate circuit serving only this appliance be provided.

Recommended grounding method

For your personal safety, this appliance must be grounded. This appliance is equipped with a power supply cord having a 3-prong grounding plug. To minimize possible shock hazard, the cord must be plugged into a mating 3-prong grounding-type wall receptacle, grounded in accordance with the National Electrical Code, ANSI/NFPA 70 — latest edition, and all local codes and ordinances. If a mating wall receptacle is not available, it is the personal responsibility and obligation of the customer to have a properly grounded 3-prong wall receptacle installed by a qualified electrician.

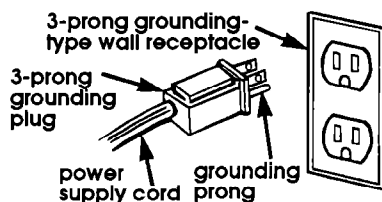

Exhaust requirements

⚠ WARNING

Fire/Health Hazard

- Do Not use non-metal, flexible duct.
- Do Not use metal duct smaller than four inches in diameter.
- Do Not Use exhaust hoods with magnetic latches.
- Check that exhaust system is not longer than specified. Exhaust systems longer than specified will:
 - Accumulate lint.
 - Shorten the life of the dryer.
 - Reduce performance, resulting in longer drying times and increased energy usage.

Failure to follow specifications may result in a fire.

- Do Not exhaust dryer into a chimney, furnace cold air duct, attic or crawl space, or any other duct used for venting.
- Clean the exhaust system every other year.
- Do Not Install flexible duct in enclosed walls, ceilings or floors.

Accumulated lint could be fuel for a fire or cause moisture damage.

Exhaust the dryer outside to prevent exposure to substances in the gas fuels and combustion which may be harmful to your health.

The moisture and lint indoors may cause:

- Lint to gather inside and around the dryer and be a fuel for fire.
- Moisture damage to woodwork, furniture, paint, wallpaper, carpet, etc.
- Housecleaning problems and possible health problems.

Failure to follow these instructions could result in fire damage, property damage, personal injury or health problems.

If using existing exhaust system, clean lint from entire length of exhaust system. Make sure exhaust hood is not plugged with lint.

Replace plastic exhaust duct with rigid metal or flexible metal duct.

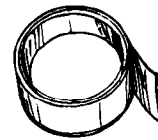

Use duct tape to seal all joints.

Four-inch rigid metal pipe is preferred. Plan installation to use the fewest number of elbows and turns.

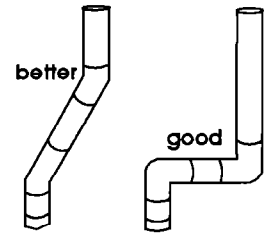

Metal flexible duct

should be fully extended and supported when the dryer is in final position. DO NOT KINK OR CRUSH THE DUCT. The metal flexible duct must be completely open to allow adequate exhaust air to flow.

Allow as much room as possible when using elbows or making runs. Bend duct gradually to avoid kinking. Remove excess flexible duct to avoid sagging and kinking that may result in reduced air flow.

The exhaust outlet

is located at the bottom rear of the dryer.

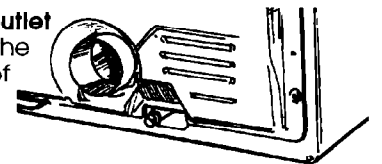

The exhaust duct can be routed up, down, left, right or straight out of the back of the dryer. General space requirements can be found in "Recessed and closet installation instructions" on the back cover. Use the straightest path you can, where possible, to avoid 90° turns.

The maximum length of the exhaust system depends upon the type of duct used, number of elbows and type of exhaust hood. The maximum length for both rigid and flexible duct is shown in chart.

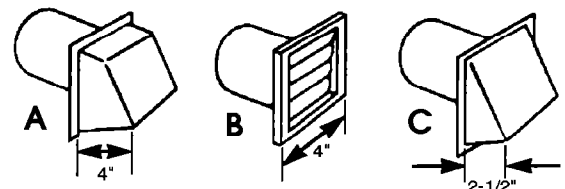

NUMBER OF 90° TURNS	EXHAUST HOOD TYPE			
	A	B	C	
0	64 FT.	64 FT.	58 FT.	MAXIMUM LENGTH OF 4" DIA. RIGID METAL DUCT.
1	54 FT.	54 FT.	48 FT.	
2	44 FT.	44 FT.	38 FT.	
3	35 FT.	35 FT.	29 FT.	
4	27 FT.	27 FT.	21 FT.	
0	36 FT.	36 FT.	28 FT.	MAXIMUM LENGTH OF 4" DIA. FLEXIBLE METAL DUCT.
1	31 FT.	31 FT.	23 FT.	
2	27 FT.	27 FT.	19 FT.	
3	25 FT.	25 FT.	17 FT.	
4	23 FT.	23 FT.	15 FT.	

The maximum length using a 2" x 6" rectangular duct with 2 elbows and a 2-1/2" (TYPE C) exhaust hood is 8 ft.

For exhaust systems not covered by the exhaust length chart, see Service Manual, Part No. 603197 available from your local parts distributor.

Service check: The back pressure in any exhaust system used must not exceed 0.6 inches of water column measured with an inclined manometer at the point that the exhaust duct connects the dryer.

An exhaust hood should cap the exhaust duct to prevent exhausted air from returning into dryer. The outlet of the hood must be at least 12 inches from the ground or anything else that may be in the path of the exhaust.

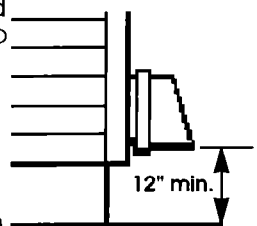

4-inch outlet hood is preferred. However, a 2-1/2 inch outlet may be used with short systems only. A 2-1/2 inch outlet can result in longer drying times than other hood types.

For permanent installation, a stationary exhaust system is required.

For mobile home

installation, the dryer must have an outside exhaust. If you exhaust the dryer through the floor and the area under your mobile home is enclosed, the exhaust system must terminate outside the enclosed area. Extension beyond the enclosure will prevent lint and moisture buildup under the mobile home.

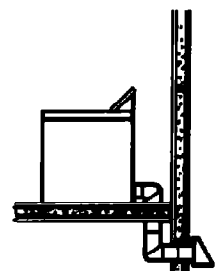

Now start...

With dryer in laundry area.

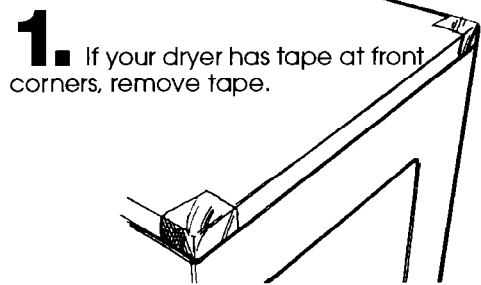

1. If your dryer has tape at front corners, remove tape.

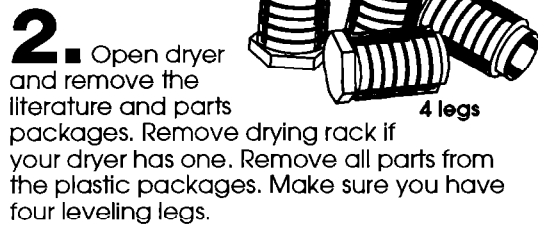

2. Open dryer and remove the literature and parts packages. Remove drying rack if your dryer has one. Remove all parts from the plastic packages. Make sure you have four leveling legs.

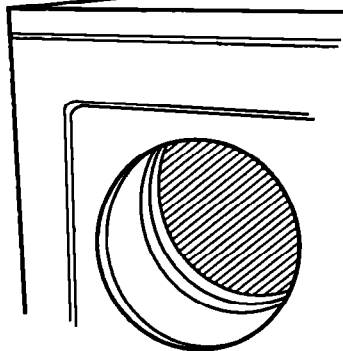

3. Wipe the interior of the drum thoroughly with a damp cloth to remove any dust before using the dryer.

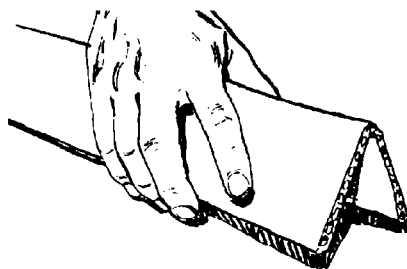

4. Take two of the corner pieces from the carton and place them on the floor in back of the dryer.

5. Firmly grasp the body of the dryer and gently lay it on its back on the cardboard corners.

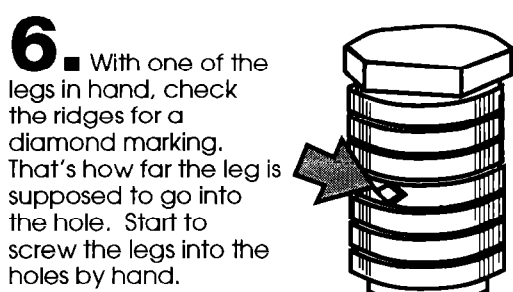

6. With one of the legs in hand, check the ridges for a diamond marking. That's how far the leg is supposed to go into the hole. Start to screw the legs into the holes by hand.

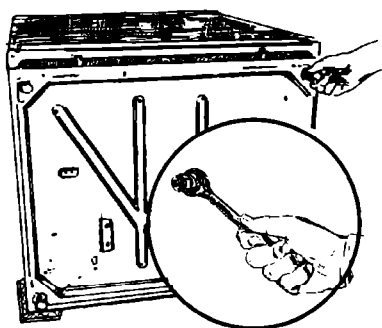

Use a wrench or 1" socket wrench to finish turning the legs until you reach the diamond mark.

CAUTION

Floor Damage

Slide dryer onto cardboard or hardboard before moving across floor. Failure to do so may cause damage to floor covering.

7. Now stand the dryer up. Slide dryer onto cardboard or hardboard.

Panel C

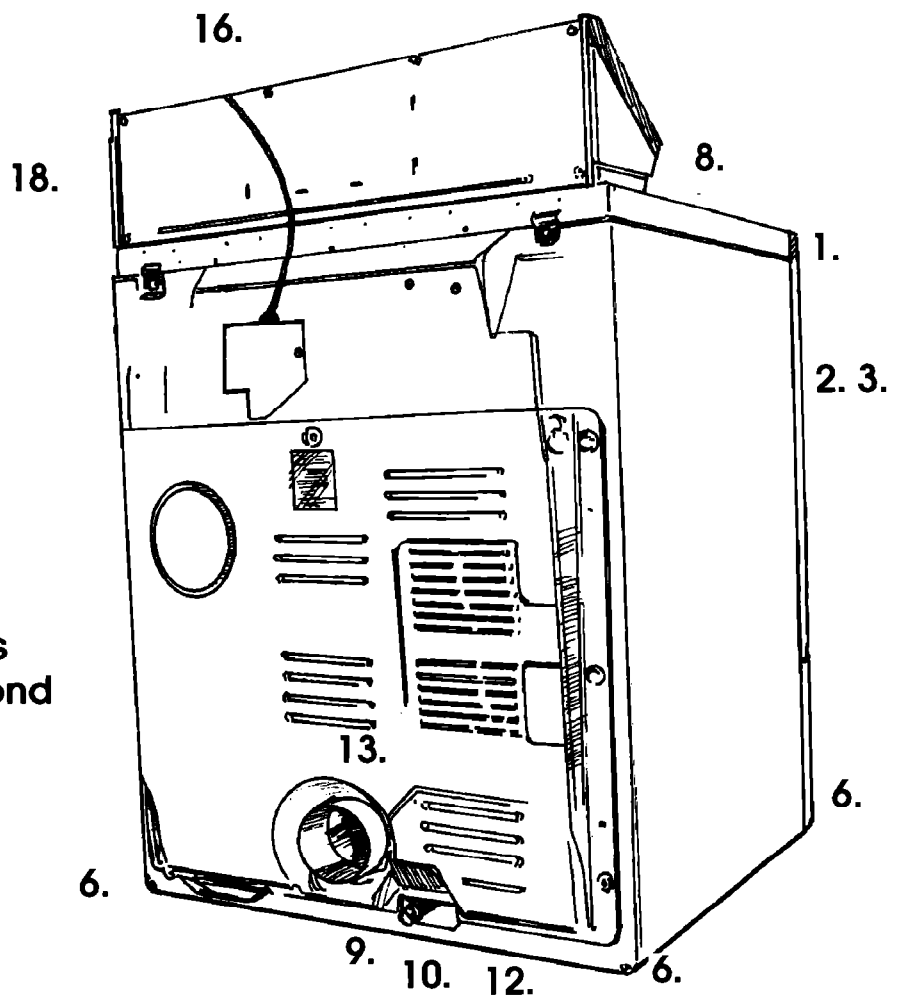

Numbers correspond to steps.

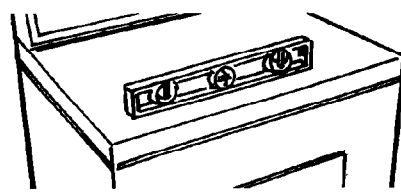

8. Move the dryer close to its final location, but leave enough room to connect exhaust duct and gas supply. Remove cardboard or hardboard. To make sure the dryer is level, take a carpenter's level and place it on the top of the dryer, first side to side, then front to back. If the dryer is not level, adjust the legs of the dryer up or down. The dryer must be level to prevent noise and to provide good drying performance.

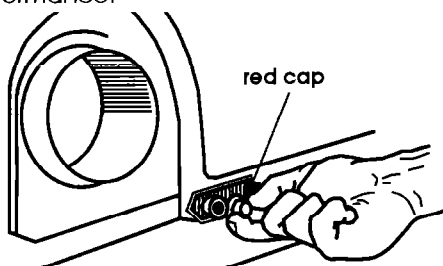

9. Remove the red cap from the gas pipe. Move the dryer into its final position.

10. Connect gas supply to dryer. Use pipe-joint compound resistant to the action of L.P. gas for gas connections. If flexible metal tubing is used, be certain there are no kinks.

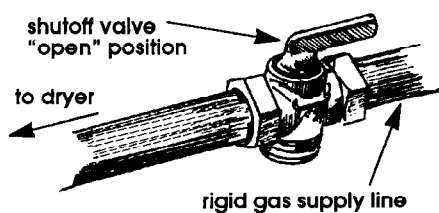

11. Turn the shutoff valve in the gas supply line to the "open" position.

WARNING

Fire Hazard

Do Not use an open flame to test for leaks from gas connections. Checking for leaks with a flame may result in a fire or explosion.

12. Use a brush and liquid detergent to test all external gas connections for leaks. Bubbles around connections will indicate a leak. If a leak appears, shut off gas valve controls and tighten connections. Then check connections again.

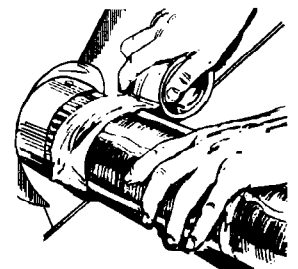

13. Connect exhaust duct to exhaust hood and dryer. (See Exhaust requirements, Panel B.)

- Use the straightest path possible to avoid 90° turns.
- Use duct tape to seal all joints in the exhaust system.
- Use caulking compound to seal exterior wall opening around exhaust hood.

14. Check that all legs are properly installed and that dryer is level.

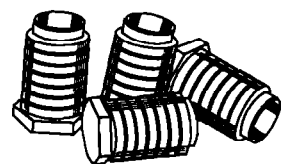

15. Check to make sure you have all the tools you started with (see Panel A).

16. Plug the power supply cord into the grounded outlet.

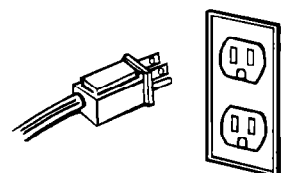

17. Carefully slide dryer into its final location. Check to be sure legs were properly installed and dryer is level.

18. Read the Use and Care Guide to fully understand your new dryer. Use a full heat cycle (not the air cycle) for at least five minutes to remove air from the gas supply line. Open the dryer door. You should feel heat inside the dryer. If you do not feel heat, shut off the dryer for five minutes. Check that the gas supply line shutoff valve is in "open" position. Repeat the five-minute test.

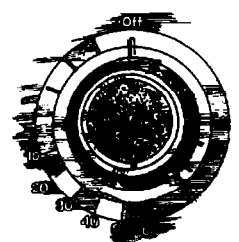

timer control knob

To get the most efficient use from your new dryer, read your Use and Care Guide. Keep Installation Instructions and Guide close to dryer for easy reference.

Recessed and closet installation instructions

⚠ WARNING

Fire/Health Hazard

- Exhaust the dryer to the outside to prevent exposure to substances in the gas fuels and combustion by-products which may be harmful to your health.
- If dryer is installed in a closet, the dryer MUST be exhausted outside.

Failure to do so may result in a fire or health hazard.

TO PREVENT LARGE AMOUNTS OF LINT AND MOISTURE FROM ACCUMULATING, TO MAINTAIN DRYING EFFICIENCY AND TO PREVENT EXPOSURE TO POSSIBLE HEALTH HAZARDS, THIS MACHINE MUST BE EXHAUSTED OUTDOORS.

Companion appliance spacings should be considered. Detailed space requirements can be found on the label located on the back panel of dryer.

NOTE: No other fuel-burning appliance may be installed in the same closet.

The following installation spacings and door air openings for the dryer are possible when installed and exhausted as noted. (Spacing as indicated is in inches and is minimum allowable. For ease of installation and service, additional spacing should be considered.)

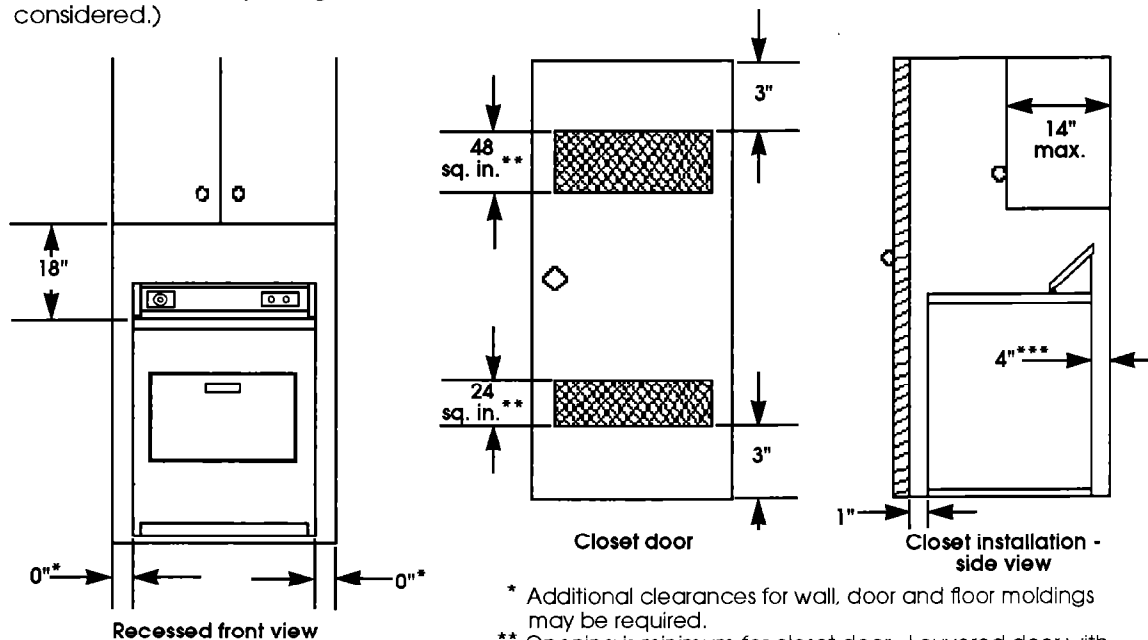

- * Additional clearances for wall, door and floor moldings may be required.
- ** Opening is minimum for closet door. Louvered door with equivalent air openings is acceptable.
- *** Additional space is needed when external exhaust elbow is used.

If dryer does not operate properly...

Before calling for service, check to be sure that:

- Electrical supply is connected.
- The house fuse has not blown or circuit breaker has not tripped.
- Door is closed.
- Controls are set in a running or "ON" position.
- Start button has been pushed firmly.
- Gas supply line shutoff valve is open.

When moving the dryer...

- Disconnect the power supply cord and tape securely to dryer.
- Shut off the gas supply valve controls in the gas supply line.
- Disconnect gas pipe fittings from dryer and cap the gas supply line.
- Tape the drum to the front panel. Tape the dryer door, lint screen lid and end of dryer gas pipe.
- Turn leveling legs all the way in.

Before installing your dryer in your new home, check with your gas supplier or dealer to see that your dryer is equipped with the correct burner for the particular type of gas in your new home. Burner information may be found on the rating plate in the door well of the dryer.

If you need assistance...

Call the dealer from whom you purchased this appliance. When you call, you will need the dryer model number and serial number. Both numbers are on the serial/rating plate located in the door well behind dryer door and on front of opening.



Printed on recycled paper.
10% post consumer waste/
50% recovered materials.