

# use & care guide

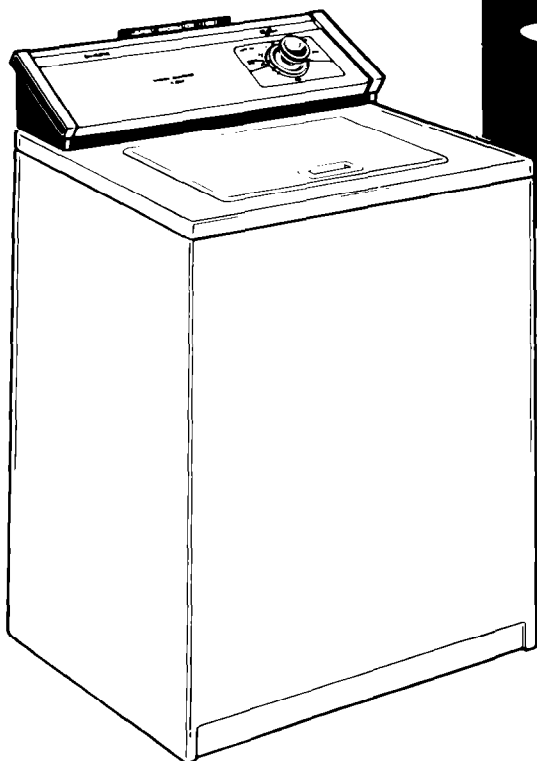

**Whirlpool**

## **AUTOMATIC WASHER**

**Design 2000®  
Large Capacity  
Model  
LA3400XP**

Wave Ovens, Trash Compactors, Room Air Conditioners, Dehumidifiers, Automatic Washers, Clothes Dryers, Freezers, Refrigerator-Freezers

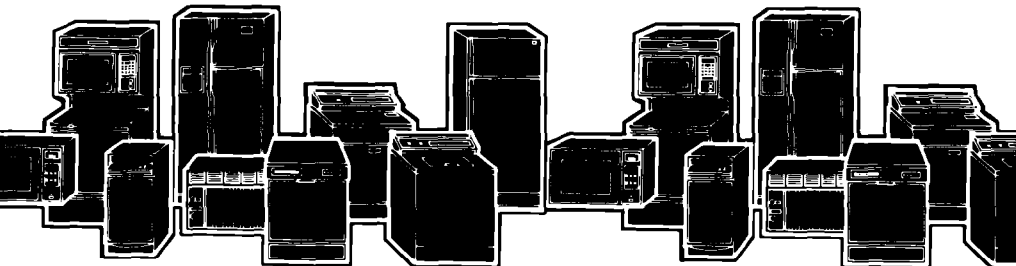

# Parts and features

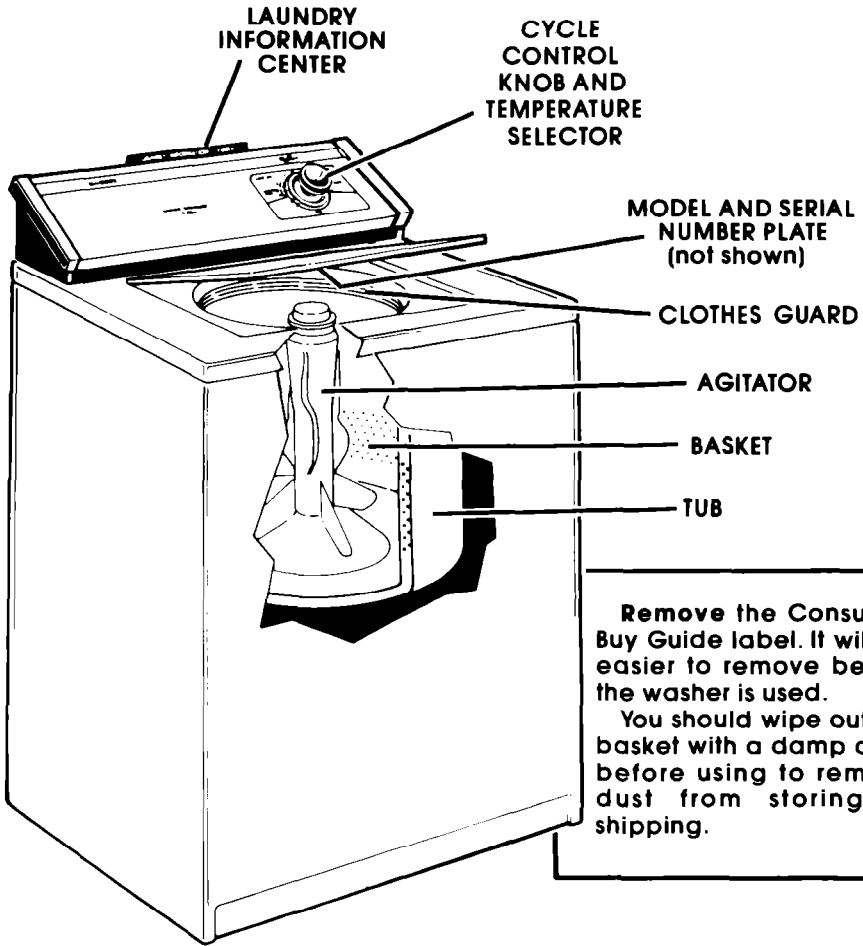

## Copy your Model and Serial Numbers here

When you need service or call with a question, have this information ready:

1. **Complete** Model and Serial Numbers (from plate under the lid near the hinge).
2. Purchase date from sales slip.

Copy this information in these spaces. Keep this book in the Laundry Information Center with your "Laundry Guide," sales slip and warranty.

\_\_\_\_\_

Model Number

\_\_\_\_\_

Serial Number

\_\_\_\_\_

Purchase Date

\_\_\_\_\_

Service Company /  
Phone Number

There is no warranty registration to return. Proof-of-purchase is all that is required for in-warranty service.

# Your responsibilities

Read this "Use and Care Guide" and your "Laundry Guide" carefully for important use and safety information.

You are personally responsible for making sure that your washer...

- is installed by a qualified installer.
- is properly installed and leveled on a floor that can support the weight.\*
- is connected to the right kind of outlet, electric supply, water supply and drain.\*
- is properly grounded.\*
- is used only for jobs normally expected of home automatic washers.
- is properly maintained.
- is protected from the weather and kept where the temperature will not fall below freezing.
- is not run by children or anyone unable to operate it properly.

\*See the "Installation Instructions" for complete information.

## Contents

	Page
<b>PARTS AND FEATURES</b> .....	2
<b>YOUR RESPONSIBILITIES</b> .....	3
<b>SAFETY FIRST</b> .....	3
<b>STARTING YOUR WASHER</b> .....	4
<b>WHAT HAPPENS IN EACH CYCLE</b> .....	6
<b>OTHER OPERATING INSTRUCTIONS</b> .....	8
For a Rinse and Spin .....	8
For a Drain and Spin .....	8
<b>CARING FOR YOUR WASHER</b> .....	9
Winterizing .....	10
<b>IF YOU NEED SERVICE OR ASSISTANCE</b> .....	11
1. Before Calling for Assistance .....	11
2. If You Need Assistance .....	11
3. If You Need Service .....	11
4. If You Have a Problem .....	11

## Safety first

**ALWAYS** unplug the power supply cord before attempting to service the washer.

**NEVER** put flammable fluids (dry-cleaning solvents, gasoline, kerosene) into your washer. **NEVER** use them near your washer.

**ALWAYS** hand launder or air dry fabrics treated with flammable fluids before putting them into your washer.

**NEVER** put your hands into the washer until all motion stops. If the lid is opened while the basket is spinning, the basket will automatically stop in a few seconds.

**DO NOT** allow children to operate or play with the washer.

**ALWAYS** store detergent, laundry aids and other materials in a cool, dry place where children can't reach them — in a locked cabinet, if possible.

**ALWAYS** read and follow instructions on packages of detergent and laundry aids — especially warnings and precautions.

**POISON GAS** can be formed if chlorine bleach is used in the same wash as ammonia or acids such as vinegar or rust remover.

**DO NOT** machine wash glass fiber materials. Small particles can stick to fabrics washed in following loads and cause skin irritation.

**SPECIAL CAUTION:** If hot water has not been used recently (usually two weeks or longer), flammable hydrogen gases may build up in the water heater and hot water pipes. To prevent injury or damage, turn on all hot water faucets and allow water to run for several minutes. This will allow gases to escape. Do not smoke or use any open flame near the faucet while it is open.

# Starting your washer

Before starting your washer:



1. Measure and add detergent.
2. Place sorted load in washer.
3. Start washer.

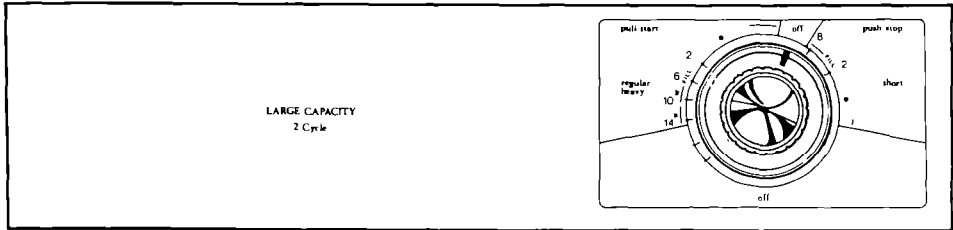

## Select CYCLE and WASH TIME; 1. Start the washer

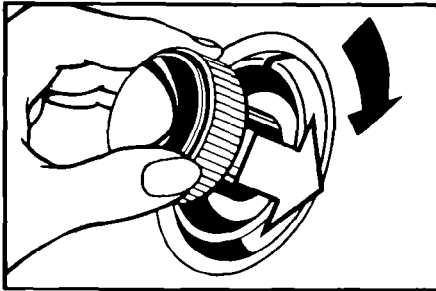

**A. Push in the Control Knob and turn it to the right.** It must be pushed in and turned only clockwise.

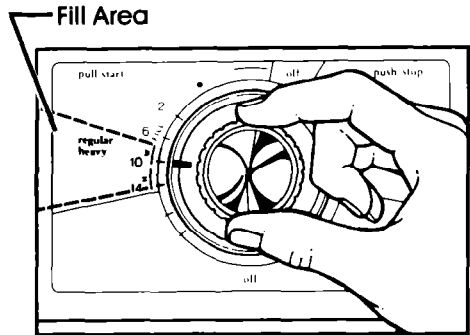

**B. Stop on a number in the cycle you want.** The numbers are minutes of wash time. The drawing shows 10 minutes of agitation in the REGULAR HEAVY Cycle. **NOTE:** The washer will fill only when the knob points to a FILL area.

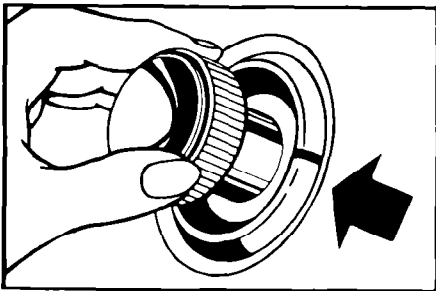

**C. Start the washer by pulling out the Control Knob.** After filling, the washer will agitate for the selected number of minutes.

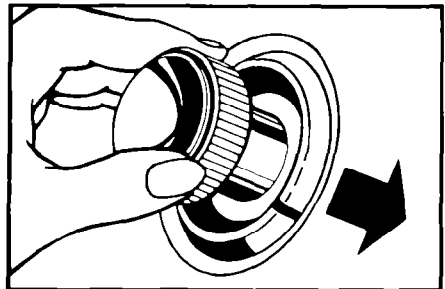

**D. To stop the washer at any time push in the Control Knob.** To restart the washer, pull out the Control Knob.

## To select a 2. WASH WATER TEMPERATURE

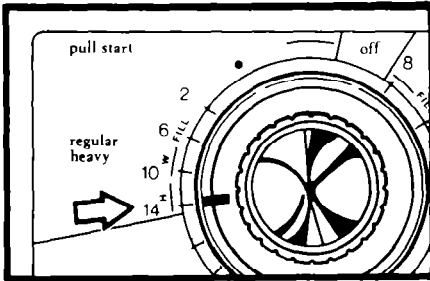

**HOT WATER** can be selected only in the **REGULAR HEAVY** Cycle. Turn the Control Knob to 12 or 14 minutes in the **REGULAR HEAVY** Cycle.

**All rinses use cold water. This saves energy and helps prevent wrinkles from setting into fabrics.**

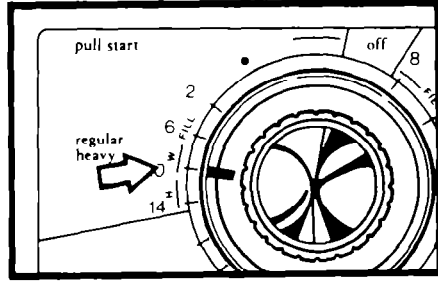

**WARM WATER** can be selected by turning the Control Knob to 8 or 10 minutes in the **REGULAR HEAVY** Cycle.

- A warm wash is preset in the **SHORT** Cycle. Just turn the Control Knob to the 6 or 8 minute setting in that cycle.

## To select a 3. WATER LEVEL

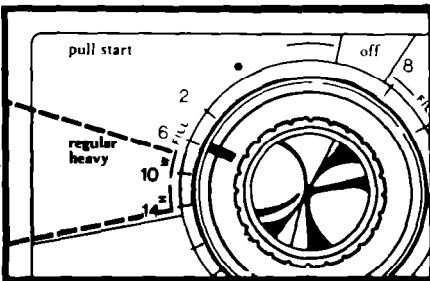

**HIGH WATER LEVEL.** The washer will automatically fill to its highest level, (about 17.2 gals./65.1 L), when the Control Knob points to a **FILL** area.

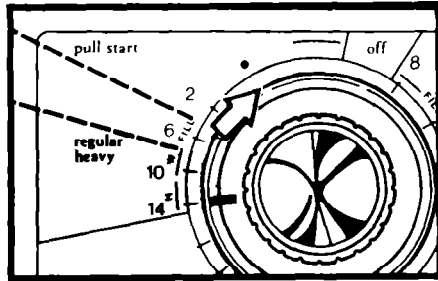

**LOWER WATER LEVELS.** Setting the washer to fill with less water also sets it for a shorter wash time.

1. Push the Control Knob in and turn it clockwise to a **FILL** area in the cycle you want.
2. Pull the Control Knob out; the washer will start to fill.
3. When the washer reaches the desired water level, **push in** the Control Knob and **slowly** turn it past the **FILL** area. **Pull out** the Control Knob to start the washer.

**For all rinses, the washer fills to its highest level with cold water.**

# What happens in each cycle\*

Each cycle has been designed for different kinds of fabrics. Numbers on the dial in each cycle are the minutes of WASH agitation time.

When the Cycle Control Knob is set to a number and pulled out, the washer fills before agitation and timing starts. After agitation starts, the knob turns

## REGULAR HEAVY Cycle

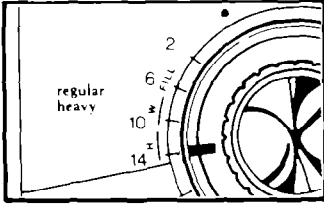

A cycle for sturdily constructed fabrics that are heavily soiled.

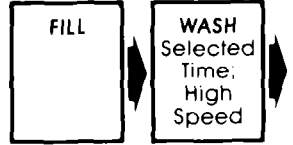

## SHORT Cycle

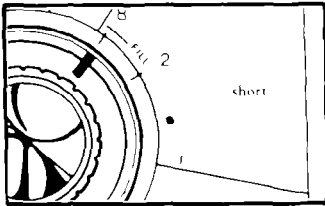

Use for delicate items that need a short wash and spin time. Wash nylon hose or panty hose in a net laundry bag.

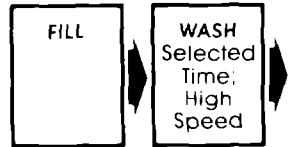

### DO NOT OVERLOAD WASHER

Overloading or packing can...

- cause poor cleaning;
- increase wrinkling;
- cause excessive lint;
- wear out or tear items.

Be careful to use enough water for the load. Too big a load or too little water can cause poor cleaning and wear or tear load items.



### DO NOT LOAD ABOVE CLOTHES GUARD

clockwise until it points to OFF and the cycle ends.

**NOTE:** You may hear the sound of water spraying during the spin parts of some cycles. In some cycles, cold water is sprayed on the spinning load to help with the rinsing.

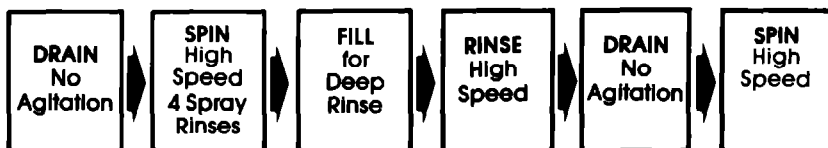
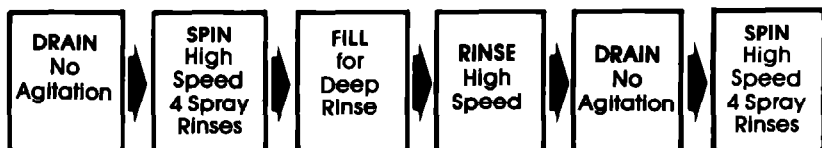

**\* IMPORTANT: THE WASHER WILL PAUSE BRIEFLY AT DIFFERENT TIMES IN EVERY CYCLE. These pauses are normal. They allow for the reversing of the motor and normal washer operations.**

# Other operating instructions

## For a rinse and spin

You may need an extra rinse and spin for heavily soiled loads which need more detergent. (Extra detergent can require an extra rinse.)

- Push Control Knob in.
- Turn clockwise to any • on the dial. **See drawing.**
- Pull Control Knob out.
- The washer will fill with cold water to selected level, agitate 2 minutes, drain and spin.

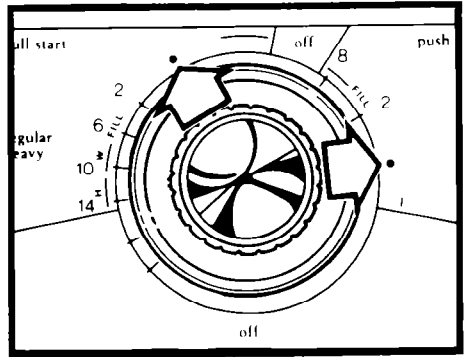

**Water level and temperature can not be adjusted in this setting.**

## For a drain and spin

Your washer can be set to drain and spin out water.

- Push Control Knob in.
- Turn clockwise to the bar just before OFF in any cycle. **See drawing.**
- Pull Control Knob out.
- The washer will drain and spin.

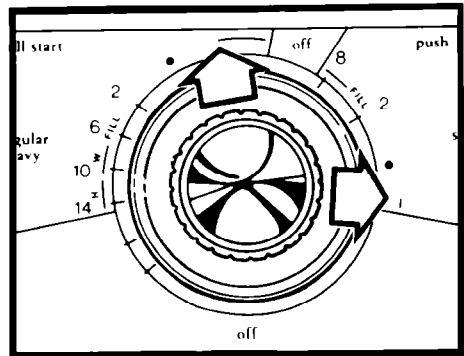



# Caring for your washer

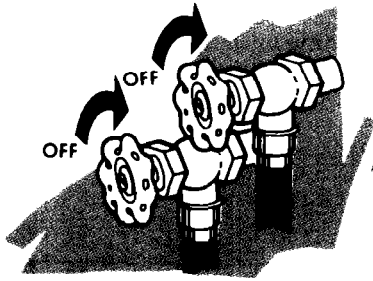

**WHEN NOT WASHING**, keep both water faucets turned off. This takes the pressure off the water inlet valve and hoses.

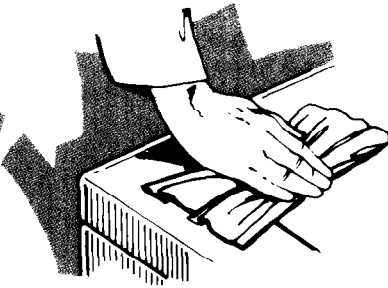

**AFTER WASHING**, use a soft dry cloth to wipe the outside and inside dry. Leave the lid up until the basket is dry. **Wipe up spills right away.** Spills can dull or damage the finish.

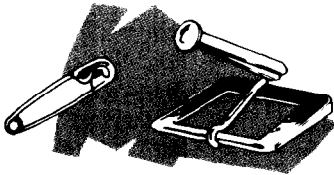

**REMOVE SHARP OBJECTS** such as pins, buckles, etc., from clothes before washing. Close metal zippers.

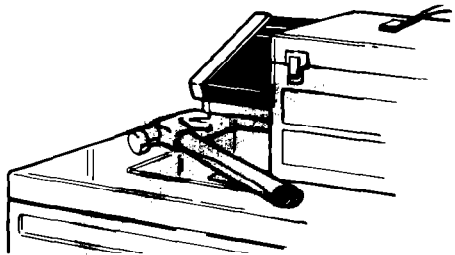

**SHARP OR HEAVY OBJECTS** should never be put on or in the washer. Check pockets for bolts, nuts, tools, etc.



## **NEVER USE THE WASHER TO ...**

- store wet or dry laundry.
- soak for more than 2 hours.
- soak with chlorine bleach.
- soak with vinegar or other acids.
- soak or store urine soaked clothes.

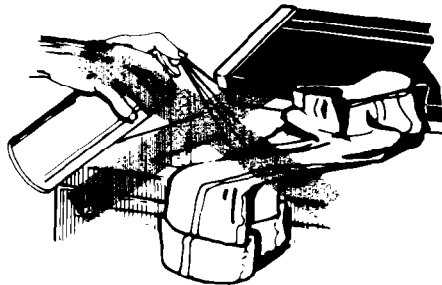

**SOME PRETREATMENT PRODUCTS** can damage washer and dryer dials, consoles and finishes. Do not use these products on or near your washer or dryer.

Service or performance problems caused by the use of any product not manufactured by Whirlpool Corporation are the responsibility of the manufacturer of that product.

# Winterizing

Because some water stays in the washer, freezing can cause a lot of damage. If your washer is **stored or moved** during the cold weather...

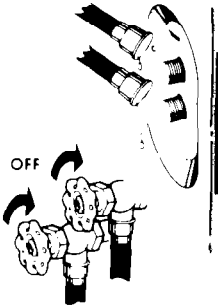
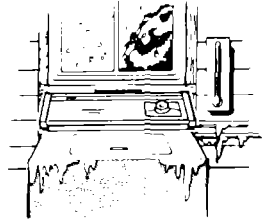

**1.** Shut off both water faucets. Disconnect and drain water inlet hoses.



**2.** Put a quart of automobile-type antifreeze in the basket.

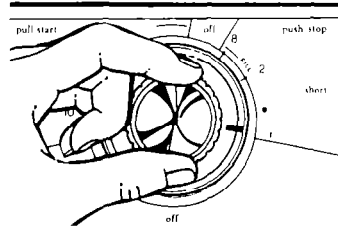

**3.** Set the washer for a **DRAIN** and **SPIN** (see page 8). Let it run for about 30 seconds to mix the antifreeze and water.

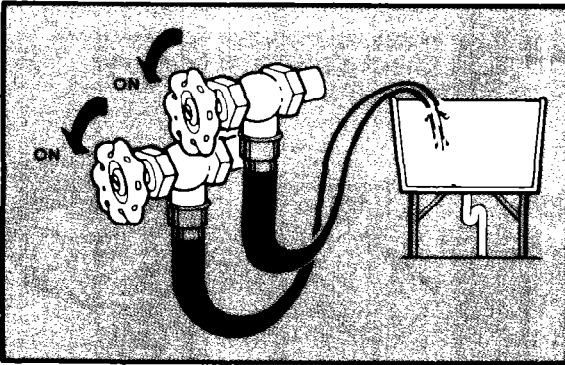

## To use the washer again...

1. Flush water pipes and hoses.
2. Connect hoses to the washer.
3. Turn on the water faucets.

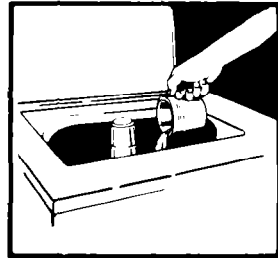

**4.** Run the washer through a complete cycle with one cup of detergent to clean out the antifreeze.

# If you need service or assistance, we suggest you follow these four steps:

## 1. Before calling for assistance...

Performance problems often result from little things you can find and fix yourself without tools of any kind.

### IF YOUR WASHER DOES NOT FILL:

- Is the power supply cord plugged in?
- Are both water faucets open?
- Are fuses blown or circuit-breaker tripped?
- Are the water supply hoses kinked?
- Is the Cycle Control Knob set and pulled out?

### IF YOUR WASHER DOES NOT SPIN:

- Is the lid closed?
- Is the power supply cord plugged in?
- Is a fuse blown or circuit-breaker tripped?

### IF YOUR WASHER STOPS DURING A CYCLE:

- Remember, the washer pauses briefly at different times in each cycle. These pauses are normal.

### MAKE SURE THE DRAIN HOSE IS HIGHER THAN THE WATER LEVEL IN THE WASHER. IF IT ISN'T...

- The washer may seem to be draining during wash and rinse cycles.
- Water can siphon out. (See "Installation Instructions.")

## 2. If you need assistance\*...

Call Whirlpool COOL-LINE<sup>®</sup> service assistance telephone number. Dial free from:

**Continental U.S. . . (800) 253-1301**  
**Michigan . . . . . (800) 632-2243**  
**Alaska & Hawaii (800) 253-1121**

and talk with one of our trained Consultants. The Consultant can instruct you in how to obtain satisfactory operation from your appliance or, if service is necessary, recommend a qualified service company in your area.

## 3. If you need service\*...



Whirlpool has a nationwide network of franchised TECH-CARE<sup>®</sup> Service Companies. TECH-CARE service

technicians are trained to fulfill the product warranty and provide after-warranty service, anywhere in the United States. To locate TECH-CARE service in your area, call our COOL-LINE service assistance telephone number (see Step 2) or look in your telephone directory Yellow Pages under:

APPLIANCES - HOUSEHOLD - MAJOR - SERVICE & REPAIR WHIRLPOOL APPLIANCES FRANCHISED TECH-CARE SERVICE SERVICE COMPANIES XYZ SERVICE CO 123 Maple . . . . . 999-9999	OR	ELECTRICAL APPLIANCES - MAJOR - REPAIRING & PARTS WHIRLPOOL APPLIANCES FRANCHISED TECH-CARE SERVICE SERVICE COMPANIES XYZ SERVICE CO 123 Maple . . . . . 999-9999
OR		
WASHING MACHINES, DRYERS & IRONERS - SERVICING WHIRLPOOL APPLIANCES FRANCHISED TECH-CARE SERVICE SERVICE COMPANIES XYZ SERVICE CO 123 Maple . . . . . 999-9999		

## 4. If you have a problem\*...

Call our COOL-LINE service assistance telephone number (see Step 2) and talk with one of our Consultants, or if you prefer, write to:

**Mr. Stephen E. Upton**  
**Senior Vice President**  
**Whirlpool Corporation**  
**Administrative Center**  
**2000 US-33 North**  
**Benton Harbor, MI 49022**

If you must call or write, please provide: model number, serial number, date of purchase, and a complete description of the problem. This information is needed in order to better respond to your request for assistance.



Making your world a little easier.

Part No. 387253  
© 1985 Whirlpool Corporation

Printed in U.S.A.

omatic Washers, Clothes Dryers, Freezers, Refrigerator-Freezers, Ice Makers, Dishwashers, Built-In Ovens and Surface Units, Ranges, M

