



# GE Refrigerators

## GE LARGE FREEZER/ REFRIGERATOR

# OPERATIONS GUIDE

MODEL NAMES/HOME APPLIANCE

**TFJ20JA**  
**TFJ22JA**  
**TPJ24BI**  
**TFJ25PA**

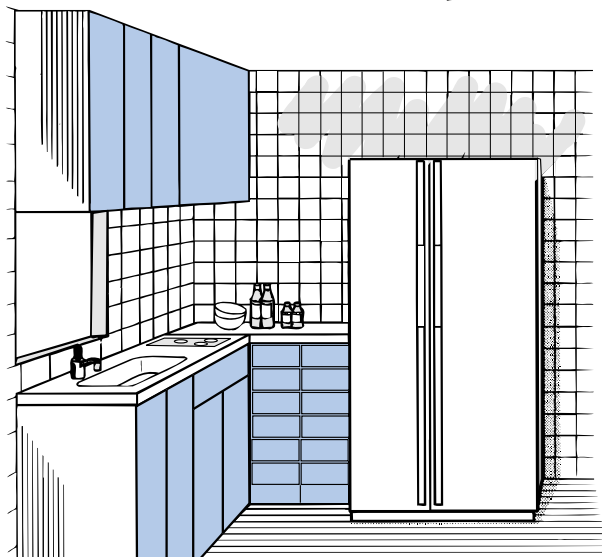
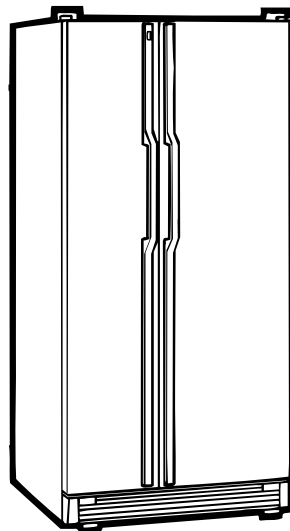

Part No. 162D9792P001  
Pub No. 49-6895

12-96

### Table of Contents

Instructions for Safe Operation .....1-7

Part Names .....8, 9

Specifications—External Dimensions .....10, 11

Instructions for Installation .....12

Instructions for Operation .....13

### Operation of Refrigerator:

Operation of Temperature Control Dials .....14

Interior Temperature Control .....15-17

Utilizing the Interior Space .....18-20

Icemaking .....21

Storage of Food .....22

What To Know About Frozen Foods .....23

Care and Cleaning of Refrigerator .....24

Self-Diagnosis of Refrigerator .....25

Warranty and After-Service .....26, 27

- Thank you very much for purchasing the GE Large Freezer/Refrigerator.
- Please read and completely understand this Operations Guide before use to ensure accurate and safe operation of this appliance.
- After reviewing, retain this guide for future reference.
- Be sure to obtain the “Warranty Note.”

For Safety

Read Before  
Using

Operation



Care, Cleaning  
& Self-Diagnosis

Warranty &  
After-Service

# INSTRUCTIONS FOR SAFE OPERATION

- Please read these safety cautions carefully and operate the refrigerator correctly.
- Please make sure to heed the safety cautions listed here, for they contain important information.

*Caution indicators and their meanings are as follows:*

	<b>DANGER</b>	This sign indicates that there is a high probability of causing death or serious injury to the operator, if mishandled.
	<b>WARNING</b>	This sign indicates that there is a possibility of causing death or serious injury to the operator, if mishandled.
	<b>CAUTION</b>	This sign indicates that there is a possibility of causing bodily injury to the operator or material damage*, if mishandled.

\* Material damage includes damage to house, furniture, pets or bedding.

## Examples of Pictorial Signs



Indicates caution (including danger, warning). Details of WARNING (caution) are posted inside or near the illustration in pictures or words.

“WARNING: ELECTRIC SHOCK”



Indicates this action is not to be done. Details of such actions are posted inside or near the illustration in pictures or words.

“DO NOT DISASSEMBLE”



Indicates forced action (must do). Details of forced actions are posted inside or near the illustration in pictures or words.

“UNPLUG”



## WARNING

Do not store flammable substances such as ether, benzene, alcohol, drugs, LP gas (cartridge for lighters).

DO NOT



• DANGER OF EXPLOSION.

Do not hang on or sit on glass shelf.

DO NOT



• DANGER OF INJURY DUE TO DOOR FALLING OR PINCHING HAND.

# INSTRUCTIONS FOR SAFE OPERATION (continued)

## WARNING

Under no circumstances should you disassemble, repair, or modify anything.

**DO NOT DISASSEMBLE**



- **DANGER OF STARTING FIRE (OR MAY CAUSE ABNORMAL OPERATION).**

Use regulation 15A only for dedicated wall outlet for the refrigerator.

**DEDICATED OUTLET**

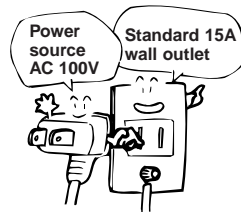

- **DANGER OF FIRE FROM OVER-HEATING IF OUTLET IS SHARED WITH OTHER APPLIANCES.**

When cleaning, unplug the power plug from the wall outlet.

**UNPLUG**



- **DO NOT HANDLE PLUG WITH WET HANDS.**
- **DANGER OF ELECTRIC SHOCK, SHORT CIRCUIT, OR INJURY.**

Do not press power plug with the back of refrigerator.

**DO NOT PRESS**

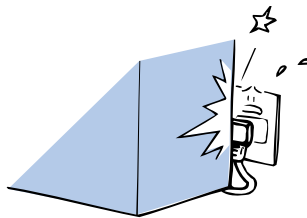

- **DANGER OF FIRE FROM OVER-HEATING BY A DAMAGED PLUG.**

When the refrigerator/freezer is out of order, stop operation by disconnecting the power plug.

**UNPLUG**

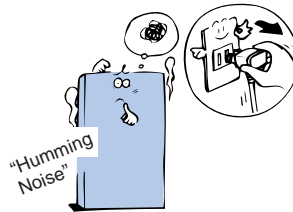

- **OPERATING THE APPLIANCE WHEN SOMETHING IS ABNORMAL COULD RESULT IN AN ELECTRIC SHOCK OR FIRE.**

The metal prongs or the prong attachment of power plug should be wiped clean with a dry cloth.

**CLEAN PLUG**

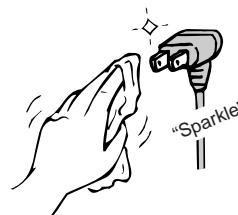

- **WIPE PLUG CLEAN WHEN DIRTY.**
- **MAY BECOME A SOURCE OF FIRE.**

# INSTRUCTIONS FOR SAFE OPERATION (continued)

## WARNING

For Safety

Connect grounding wire.

**CONNECT GROUNDING**

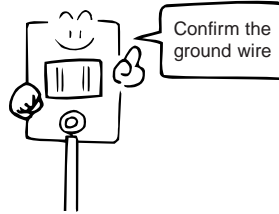

- **DANGER OF MALFUNCTION OR SHORT CIRCUIT.**
- **PLEASE CONSULT DEALERSHIP WHEN CONNECTING GROUNDING.**

Do not install in a location where freezing is possible.

**DO NOT INSTALL**

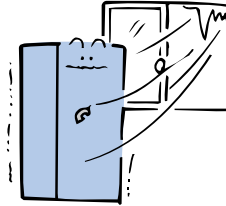

- **DANGER OF RUPTURED HOSES, PIPES, VALVES, ETC., LEAKING WATER.**

Do not store medicines or scientific specimens in refrigerator.

**DO NOT STORE**

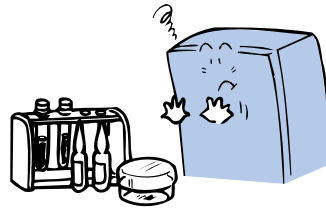

- **SUBSTANCES REQUIRING STRICT TEMPERATURE CONTROL SHOULD NOT BE STORED IN A HOME REFRIGERATOR.**

In the event of a city gas leak, provide good ventilation by opening the doors. Do not touch refrigerator or wall outlet.

**VENTILATE**

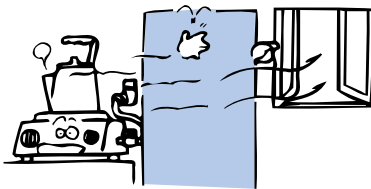

- **POSSIBILITY OF FIRE LEADING TO AN EXPLOSION.**

Discard foods which are discolored or foul smelling due to malfunctioning of the refrigerator.

**DISCARD SPOILED FOODS**



- **SPOILED FOOD CAN BE HARMFUL.**

Do not splash water outside and/or inside the refrigerator.

**DO NOT SPLASH WATER**

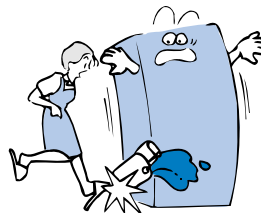

- **DANGER OF ELECTRIC SHOCK OR SHORT CIRCUIT.**

# INSTRUCTIONS FOR SAFE OPERATION (continued)



## WARNING

Do not use flammable sprays (hair spray, insecticide, etc.) near refrigerator.

DO NOT USE



- DANGER OF FIRE BY IGNITION.

Do not place heavy objects on top of refrigerator.

DO NOT

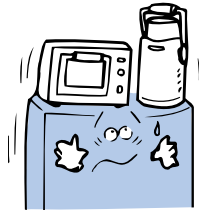

- DANGER OF INJURY CAUSED BY FALLING OBJECTS WHEN DOOR IS OPENED AND CLOSED.

Do not place a container with water on top of refrigerator.

DO NOT

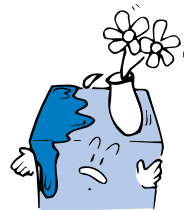

- DANGER OF FIRE CAUSED BY SHORT CIRCUIT DUE TO DETERIORATION OF ELECTRICAL INSULATION BY SPILLED WATER.

When disposing of a refrigerator, remove door gasket.

REMOVE GASKET

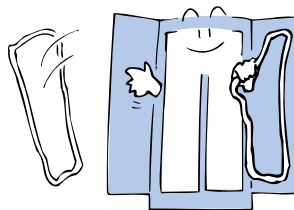

- IT IS DANGEROUS IF A CHILD IS TRAPPED INSIDE.

Unplug power plug when replacing interior light bulb.

UNPLUG



- POSSIBILITY OF ELECTRIC SHOCK.

Do not touch the ice-making part of the automatic icemaker.

DO NOT TOUCH

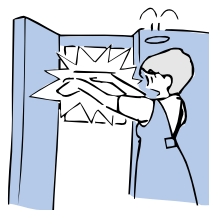

- INJURY COULD RESULT WHEN ICE TRAY ROTATES.
- HEATER BECOMES HOT AND COULD CAUSE BURNS.

# INSTRUCTIONS FOR SAFE OPERATION (continued)

For Safety

## WARNING

Secure the refrigerator in place to prevent it from toppling over during an earthquake.

**PREVENT FROM TOPPLING OVER**

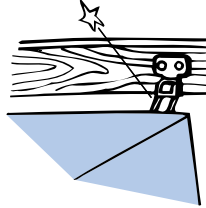

- **COULD RESULT IN INJURIES IF THE REFRIGERATOR TOPPLES OVER.**

The adjustable shelves and baskets should be attached securely to designated points in the refrigerator.

**ATTACH SHELVES SECURELY**



- **DANGER OF CAUSING INJURIES DUE TO SHELVES COMING LOOSE AND FALLING IF NOT SECURELY ATTACHED.**

Piping for the icemaker should be installed in accordance with the wiring and piping schematics.

**INSTALLATION WARNING**



- **UNIT MAY LEAK IF NOT INSTALLED CORRECTLY.**

## CAUTION

A 100V alternating current power source is to be used for the wall outlet.

**100V ONLY**

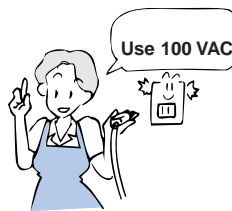

- **POSSIBILITY OF FIRE OR ELECTRIC SHOCK.**

Do not pull cord when disconnecting power plug.

**DO NOT PULL**

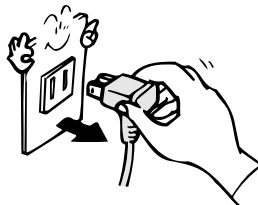

- **UNPLUG BY HOLDING THE POWER PLUG.**
- **ELECTRIC SHOCK OR SHORT CIRCUIT COULD RESULT.**

# INSTRUCTIONS FOR SAFE OPERATION (continued)

## CAUTION

For Safety

Do not use a damaged cord, power plug, or loose wall outlet.

**DO NOT USE**



- **POSSIBILITY OF ELECTRIC SHOCK, SHORT CIRCUIT, OR FIRE.**

Do not damage the electric power cord.

**DO NOT DAMAGE**

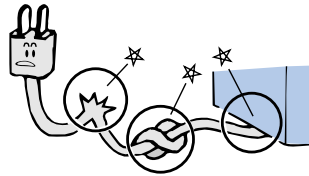

- **DO NOT DAMAGE, BREAK, ALTER, FORCIBLY BEND, PULL, TWIST, OR BUNDLE THE ELECTRIC POWER CORD. DO NOT PLACE A HEAVY OBJECT ON IT, CRIMP IT, OR ALTER IT IN ANY WAY.**
- **A BROKEN CORD MAY CAUSE FIRE OR ELECTRIC SHOCK.**

Install the refrigerator in a location away from excess moisture or where water may be present.

**KEEP DRY**



- **INSULATION WILL DETERIORATE AND CAUSE A SHORT CIRCUIT.**

Unplug the power plug from wall outlet when the refrigerator will not be used for an extended period of time.

**UNPLUG**

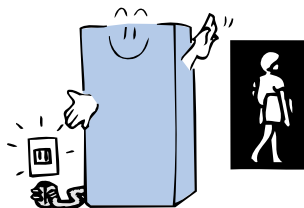

- **DETERIORATING INSULATION COULD CAUSE AN ELECTRIC SHOCK OR SHORT CIRCUIT.**

Do not store bottles or cans in freezer compartment.

**NO BOTTLES**

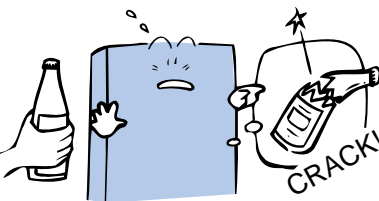

- **CONTENTS WILL FREEZE CAUSING THE BOTTLES TO EXPLODE WHICH MAY CAUSE INJURIES.**

Close the refrigerator door by holding the door handle.

**USE DOOR HANDLE**

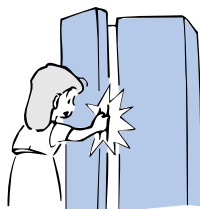

- **DANGER OF INJURY TO FINGERS IF THE DOOR HANDLE IS NOT USED WHEN CLOSING DOOR.**

# INSTRUCTIONS FOR SAFE OPERATION (continued)

## CAUTION

Hire professional movers to move the refrigerator, because it is heavy and dangerous to move.

**EMPLOY PROFESSIONAL MOVERS**

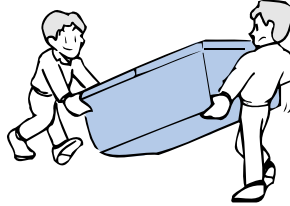

- DANGER OF INJURIES BY ATTEMPTING TO MOVE THE REFRIGERATOR YOURSELF.
- CONSULT YOUR DEALERSHIP OR A PROFESSIONAL MOVER TO TRANSPORT THE REFRIGERATOR.

Do not touch food or containers (metallic) inside the freezer compartment with wet hands.

**DO NOT TOUCH**



- FREEZING TEMPERATURES MAY CAUSE FREEZER BURN.

Install refrigerator on a sturdy flat floor.

**DO NOT INSTALL**

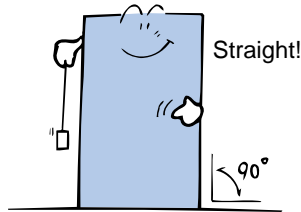

- INSTALLING ON AN UNSTEADY FLOOR COULD CAUSE THE REFRIGERATOR TO TOPPLE WHEN OPENED AND CLOSED AND COULD CAUSE INJURY.

Do not put hands under the refrigerator.

**DO NOT TOUCH**



- METAL PLATES AND ROTATING PARTS LOCATED UNDER THE REFRIGERATOR MAY CAUSE INJURY.

Do not re-freeze foods after they have been thawed.

**FOOD POISONING WARNING**



- CONSUMING SPOILED FOODS IS HARMFUL.

If you resell or give away this appliance, provide the new owners with this Operations Guide.

**PROVIDE OPERATIONS GUIDE**

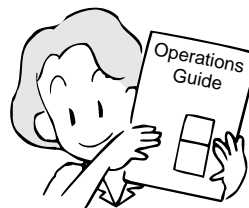

- THE NEW OWNER WILL NEED THIS OPERATIONS GUIDE FOR SAFE AND CORRECT USE.



# PART NAMES

## TFJ20JA

### Freezer Compartment

- ① Refrigerator Interior Light
- ② Door Pockets (6 levels)
- ③ Compartment Shelves (3 levels)
- ④ Large Freezer Basket  
Pull-out type: chicken and large pieces of meat, etc., can be stored.
- ⑤ Icemaker Trays (2 dishes)
- ⑥ Ice Box

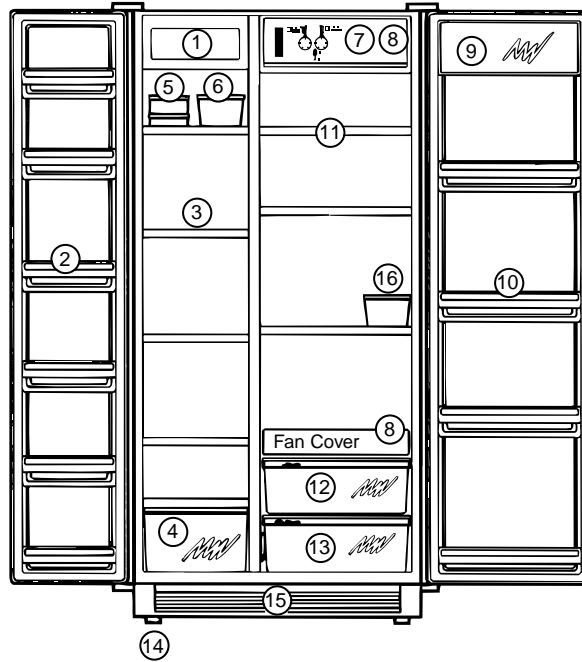

### Refrigerator Compartment

- ⑦ Temperature Control Dial
- ⑧ Interior Lamp
- ⑨ Astro-Door (flip door)  
Type Utility Compartment (shelf for storing milk products such as cheeses, butter, etc.)
- ⑩ Door Pockets (4 levels)
- ⑪ Interior Shelf (3 levels)  
Height can be adjusted according to the size of foods.
- ⑫ High Humidity Vegetable Compartment
- ⑬ Chilling/Vegetable Compartment
- ⑭ Four Wheel Castors
- ⑮ Front Grille
- ⑯ Utility Box (can be used as egg case also)

Read Before Using

## TFJ22JA

### Freezer Compartment

- ① Refrigerator Interior Light
- ② Door Pockets (6 levels)
- ③ Compartment Shelves (4 levels)
- ④ Large Freezer Basket  
Pull-out type: chicken and large pieces of meat, etc., can be stored.
- ⑤ Icemaker Trays (2 dishes)
- ⑥ Ice Box

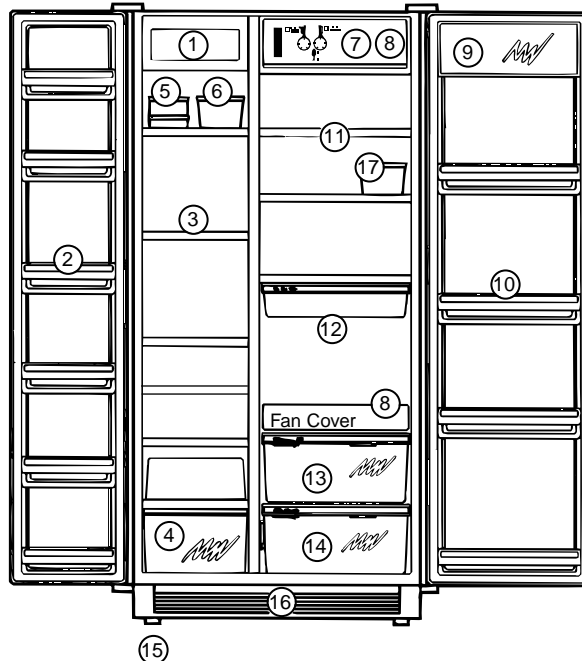

### Refrigerator Compartment

- ⑦ Temperature Control Dial
- ⑧ Interior Lamp
- ⑨ Astro-Door (flip door)  
Type Utility Compartment (shelf for storing milk products such as cheeses, butter, etc.)
- ⑩ Door Pockets (4 levels)
- ⑪ Interior Shelf (3 levels)  
Height can be adjusted according to the size of foods.
- ⑫ Meat/Snack Case
- ⑬ High Humidity Vegetable Compartment
- ⑭ Chilling/Vegetable Compartment
- ⑮ Four Wheel Castors
- ⑯ Front Grille
- ⑰ Utility Box (can be used as egg case also)

# PART NAMES (continued)

## TPJ24BI & TFJ25PA

### Freezer Compartment

- ① Refrigerator Interior Light
- ② Door Pockets (5 or 6 levels)
- ③ Compartment Shelves (3 levels)
- ④ Large Freezer Basket  
Pull-out type: chicken and large pieces of meat, etc., can be stored.
- ⑤ Automatic Icemaker (TPJ24BI only)

### Refrigerator Compartment

- ⑥ Temperature Control Dial
- ⑦ Internal Lamp
- ⑧ Internal Shelf (3 levels)
- ⑨ Wine Rack
- ⑩ Airtight Snack Case
- ⑪ High Humidity Vegetable Compartment
- ⑫ Chilling/Vegetable Compartment
- ⑬ Astro-Door (flip door) Type Utility Compartment
- ⑭ Jumbo Door Pocket (4 levels)
- ⑮ Four Wheel Castors
- ⑯ Front Grille
- ⑰ Utility Box (can be used as egg case also)

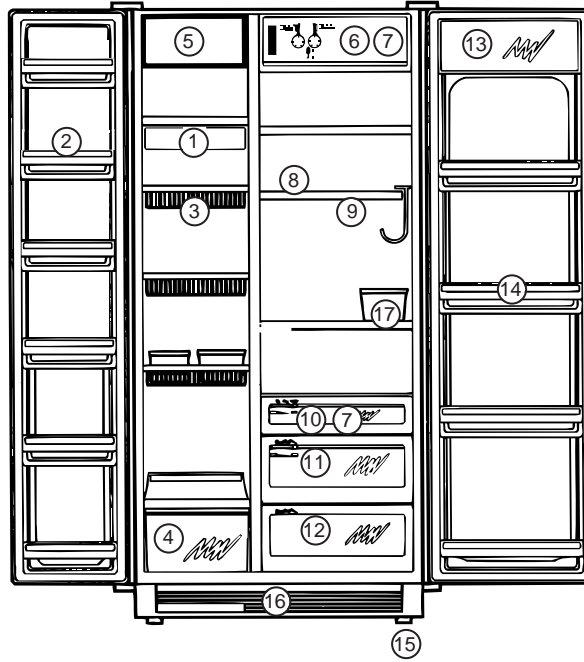

Read Before  
Using

# SPECIFICATIONS

		UNITS	TFJ25PA	TPJ24BI	TFJ22JA	TFJ20JA
USEFUL VOLUME	TOTAL	(L)	707	655	605	547
	FREEZER	(L)	260	250	187	187
	FRESH FOOD	(L)	447	405	418	360
ELECTRICAL POWER	VOLTAGE	(V)	SINGLE PHASE 100/100			
	FREQUENCY	(Hz)	50/60			
SOURCE	MOTORS	(W)	133/156	131/146	124/142	122/139
	HEATERS	(W)	545/545	670/670	464/464	464/464
AVG MONTHLY ELECTRICAL CONSUMPTION (KWH/MON)			78/82	75/76	63/66	63/67
COOLING METHOD AND FREEZER CODE			COLD AIR CIRCULATION TYPE (INDIRECT COOLING) <b>****</b>			
CONDENSER COOLING			FORCED AIR (FAN COOLED CONDENSER)			
DEFROST CONTROL			AUTO START - AUTO STOP			
DEFROST WATER REMOVAL			FORCED AIR EVAPORATION			
AUTOMATIC ICEMAKER			NO	YES	NO	NO
MOBILITY WHEELS			ATTACHED			
BUILT-IN			POSSIBLE			
DOOR REVERSIBILITY			-			
ELECTRICAL RATING		(A)	15			
WEIGHT		(Kg)	143	159	132	123
CORD LENGTH		(M)	2.2			

\* Values for useful internal volume and the Electrical Standard Values are based on the Japanese Industry Standard (JIS C9607).

\* Values separated by “/” indicate 50 Hz on left and 60 Hz on right. Others indicate common 50 Hz and 60 Hz.

## ● Freezer Performance

This freezer/refrigerator is “Four Star” **\*\*\*\*** coded.

Performance of freezer is classified by codes.

Each code indicates the performance capability according to the regulation delineated in the Japanese Industry Standard (JIS C9607). The regulation defines the test conditions for measuring the freezing-load temperature (food temperature). The following table shows the test results:

CODE	FREEZING-LOAD TEMP. (FOOD TEMPERATURE)	FROZEN FOOD PRESERVATION ESTIMATED TIME
<b>*</b>	Below -6°C.	Approx. 1 week
<b>**</b>	Below -12°C.	Approx. 1 month
<b>***</b> or <b>****</b>	Below -18°C.	Approx. 3 months

# EXTERNAL DIMENSIONS

Read Before  
Using

## TFJ20JA

(Units: mm)

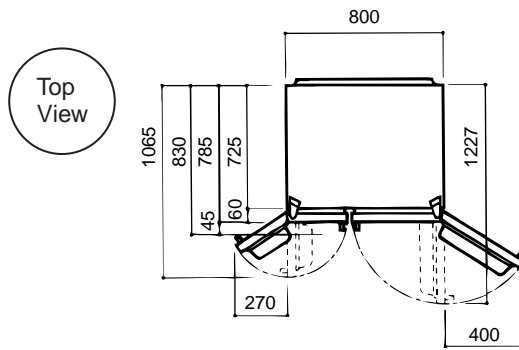

Side View

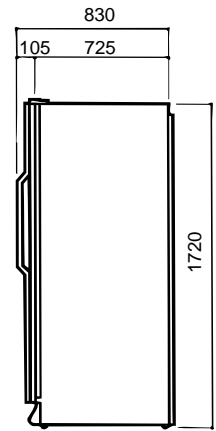

## TFJ22JA

(Units: mm)

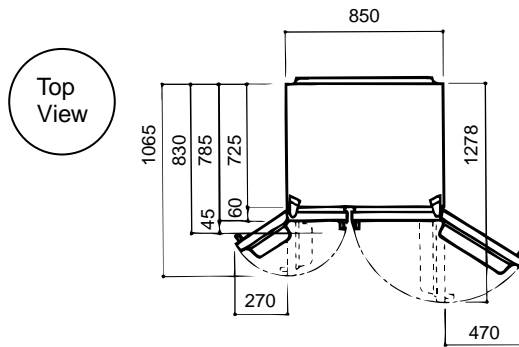

Side View

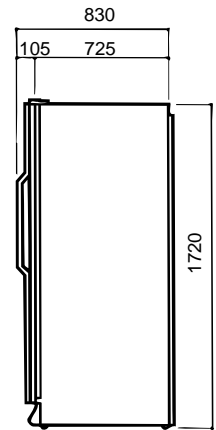

## TPJ24BI

(Units: mm)

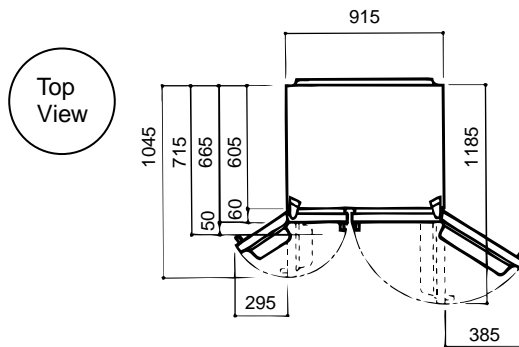

Side View

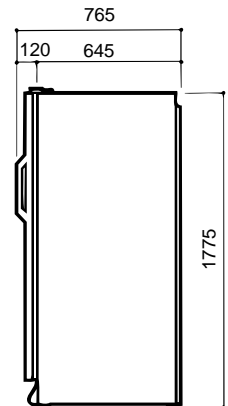

## TFJ25PA

(Units: mm)

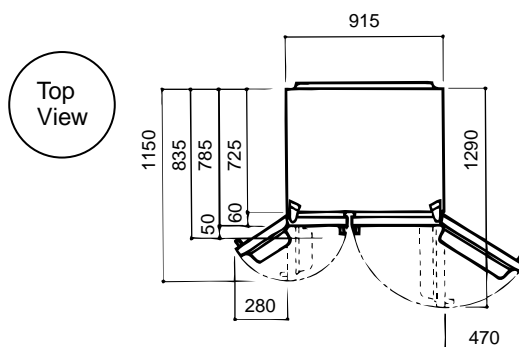

Side View

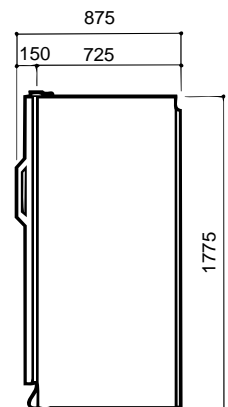

# INSTRUCTIONS FOR INSTALLATION

1

Refrigerator should be installed on a firm and level floor.

If the floor is not firm, noise or vibration may occur. When opening and closing the door, the refrigerator may topple and cause injuries.

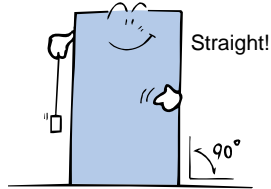

2

Place a firm board under the refrigerator when installing it on a weak floor, on a tatami, or on a carpet.

If the refrigerator is installed directly on carpet or other mats, the compressor under the refrigerator may touch the mat, causing discoloration of the mat, or may interfere with the cooling capability by reducing air flow.

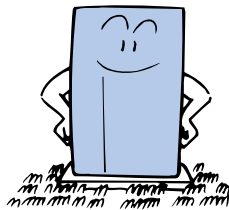

3

If the refrigerator is tilted, adjust with leveling screws under the front end. The front end of the refrigerator should be slightly higher so the door will close when lightly pushed.

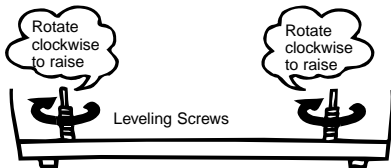

4

Install away from heat sources.

Avoid locations in direct sunlight or near heat-producing appliances (range, heater, etc.). Cooling efficiency may be lowered or external color changes may result.

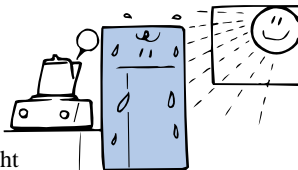

5

Install in a low-humidity location.

An electrical short circuit or rusting may occur. If it is necessary to install in a washroom or on a damp floor, be sure to provide gaps by placing the refrigerator on some sort of blocks.

**CAUTION:** This type of refrigerator uses forced fan cooling. Therefore, to prevent reduction in the cooling capacity, place the refrigerator on top of a firm board before placing it on blocks. Do not place the refrigerator directly on top of the blocks.

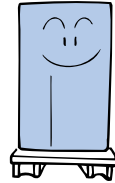

6

Allow sufficient space around the refrigerator as shown in diagrams below.

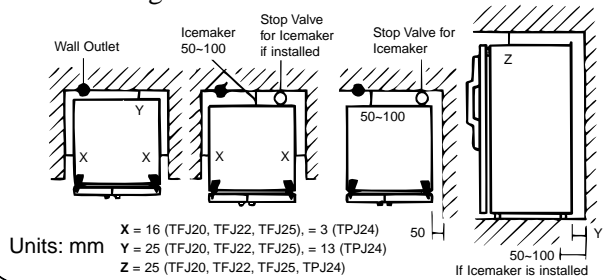

7

To avoid electric shock, ground the refrigerator.

Consult dealer for grounding installations. (Fee will be charged for grounding installations.)

**NOTE:** A grounding wire is attached to this refrigerator. Please connect these grounding terminals correctly.

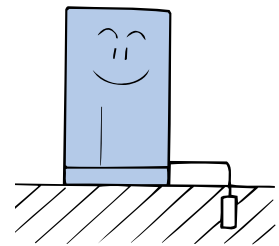

8

Do not put anything in front of the grille.

Since air is suctioned in from the front of the grille, obstructing the grille could lower the cooling capacity.

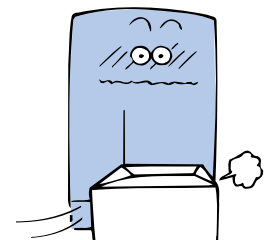

Read Before Using

# INSTRUCTIONS FOR OPERATION

## 1 CAUTION DURING POWER OUTAGE

### Sudden interruption of electricity

- Limit the frequency of opening and closing the door. If the door is kept closed, the refrigerator should maintain its temperature for approximately 2 hours and the freezer for approximately 1 hour.

### For expected outage

- Accumulate a lot of ice. The refrigerator can be maintained by cooling with ice.
- The refrigerator can be maintained longer if it is cooled for 2–3 hours prior to a blackout by setting the temperature control dial to the HIGH cooling position.
- Store as little food as possible. Fresh foods should be consumed first.

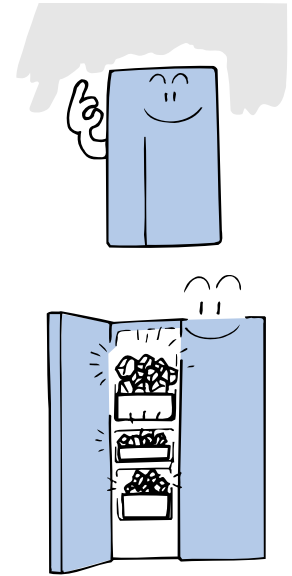

## 2 CAUTIONS DURING EXTENDED SHUTDOWN

When the refrigerator will not be used for an extended period of time, follow the procedures outlined below to prevent odor and mildew:

1. Remove all foods.
2. Clean out refrigerator and keep the door open for a few days to dry out inside.



## 3 CAUTIONS WHEN DISCARDING

To prevent a child from being locked inside, take the following measures when disposing of a used refrigerator or freezer:

1. Do not discard a refrigerator or a freezer in a location where children might play.
2. Hinges should be destroyed to prevent an airtight seal.
3. Remove door and gasket.

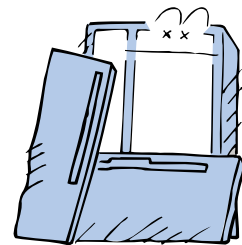

# OPERATION OF TEMPERATURE CONTROL DIALS

## 1 SET AT POSITION “5” FOR NORMAL USE

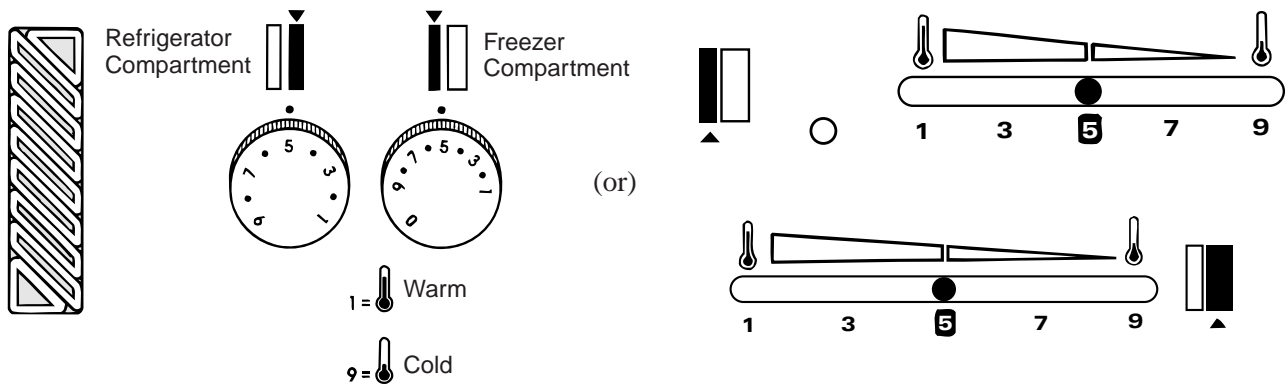

## 2 FREEZER COMPARTMENT

The freezer temperature is adjusted by moving the dials as shown in the diagrams.

Set dial at “5” for normal operation.

If the dial is set at “1,” temperature of the freezer is increased.

If the dial is set at “9,” temperature of the freezer is decreased.

**CAUTION:** If the dial is set at “0,” the refrigerator will shut off regardless of the position of the refrigerator compartment dial.

Dial Setting	Temperature	Operations
1 3	HIGH	Food is to be stored for shorter periods of time.
5	MEDIUM	Normal
7 9	LOW	Food is to be stored for longer periods of time.

## 3 REFRIGERATOR COMPARTMENT

Set the refrigerator temperature control dial to “5” for normal operation. If the dial is turned toward “1,” the refrigerator temperature becomes high and, if turned toward “9,” temperature becomes low.

Dial Setting	Temperature	Operations
1 3	HIGH	For storage of foods at higher temperatures.
5	MEDIUM	Normal
7 9	LOW	For storage of foods at lower temperatures.

# INTERIOR TEMPERATURE CONTROL

## NOTICE: NEW FREEZING ROOM TEMPERATURE FEATURE

YOUR REFRIGERATOR HAS BEEN DESIGNED TO INCLUDE A FEATURE THAT WILL PREVENT THE CONTENTS OF THE REFRIGERATOR COMPARTMENT FROM FREEZING, EVEN IF THE ROOM TEMPERATURE IS BELOW FREEZING. THIS IS A TOTALLY AUTOMATIC SYSTEM AND WILL REQUIRE NO ACTION ON YOUR PART. THIS SYSTEM PROVIDES THIS FEATURE BY PERIODICALLY TURNING THE LIGHTS IN THE REFRIGERATOR COMPARTMENT ON AND OFF. THE WARMTH FROM THESE LIGHTS WILL AUTOMATICALLY KEEP THE FOOD FROM FREEZING. THIS SYSTEM OPERATES AT ROOM TEMPERATURES FROM 15°C. TO -5°C. THE SYSTEM WILL TURN ON THE LIGHTS ONLY WHEN NEEDED. IF YOU SHOULD NOTICE THAT THE REFRIGERATOR LIGHTS ARE ON, EVEN THOUGH THE DOOR IS CLOSED, THIS IS THE SYSTEM AT WORK, KEEPING YOUR FRESH FOOD FROM FREEZING.

### How to Prevent Freezing

**NOTE: IF YOU EXPECT THE ROOM TEMPERATURE TO FALL BELOW FREEZING, AND YOUR REFRIGERATOR HAS THE ICE/WATER DISPENSER FEATURE BUILT INTO THE FREEZER DOOR, OR HAS AN ICEMAKER, THEN YOU SHOULD PERFORM THE FOLLOWING STEPS. THIS DEACTIVATES THE ICE/WATER SYSTEM AND WILL PREVENT THE EXTERNAL WATER LINES FROM FREEZING.**

1. Disconnect power to the refrigerator.
2. Close valve on water line connecting refrigerator to main water supply.
3. Position a container under the refrigeration connection to collect any spillage and disconnect inlet water supply line from refrigerator. Also collect water from the inlet supply line.
4. Position the container under the plastic outlet tube that supplies the icemaker (on Refrigerator side) to collect any water spillage and disconnect the tube.
5. Position the container under the plastic outlet tube that supplies the water tank (on Freezer side) to collect any water spillage and disconnect the plastic outlet tube.
6. Reconnect the icemaker and water tank tubes to the water inlet valve.
7. Turn off the icemaker (inside freezer) by moving sensor arm to the “UP” locked position.
8. Remove the front grille.
9. Position a container under the water line connectors located under the freezer, to collect any spillage, and disconnect the two ends of the water line.
10. Allow water to drain from the two ends.
11. Reconnect the two ends of the water line.
12. Install the front grille.
13. Reconnect power to the refrigerator.

### How to Restore to Normal Condition

**NOTE: WHEN THE ROOM TEMPERATURE RISES ABOVE FREEZING, YOU CAN REACTIVATE YOUR ICE/WATER DISPENSER SYSTEM BY PERFORMING THE FOLLOWING STEPS:**

1. Disconnect power to the refrigerator.
2. Reconnect the inlet water supply line to the refrigerator.
3. Open the valve on water line connecting refrigerator to main water supply.
4. Turn on the icemaker (inside freezer) by moving sensor arm to the “DOWN” unlocked position.
5. Reconnect power to the refrigerator.
6. Dispense water from freezer door. Throw away the first few glasses.
7. Check all connections for leaks. Tighten as necessary.



# INTERIOR TEMPERATURE CONTROL (continued)

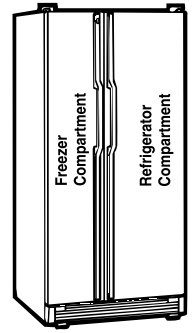

## 1 NORMAL OPERATION

For normal operation, set the dials as shown below:

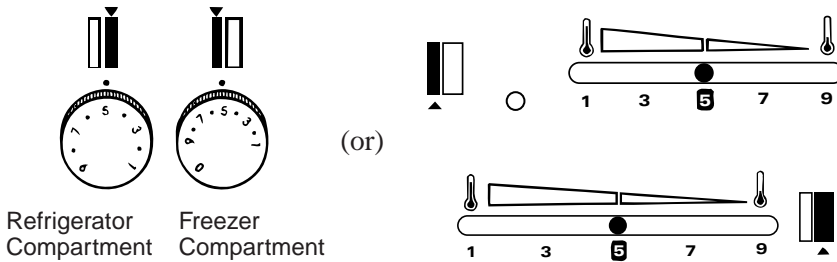

FREEZER COMPARTMENT	REFRIGERATOR COMPARTMENT

## 2 ADDITIONAL COOLING ON REFRIGERATOR COMPARTMENT SIDE

Use this setting when food is to be stored at low temperatures. This setting is likely to be frequently used during warmer months. Temperature dials should be set at 7-9, as needed.

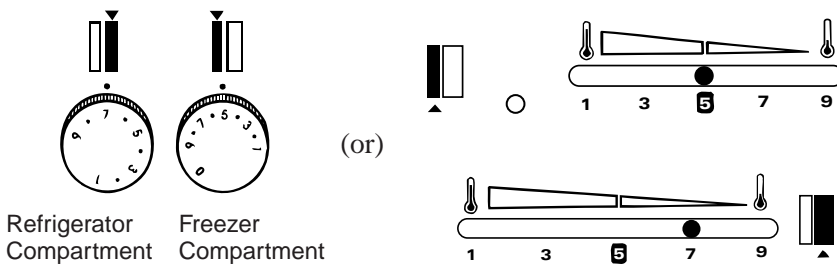

FREEZER COMPARTMENT	REFRIGERATOR COMPARTMENT

Operation

# INTERIOR TEMPERATURE CONTROL (continued)

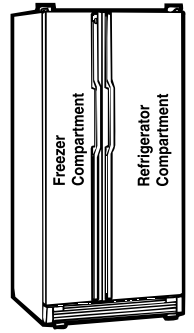

## 3 ADDITIONAL COOLING ON FREEZER COMPARTMENT SIDE

Use this setting when food is to be stored for longer periods of time.

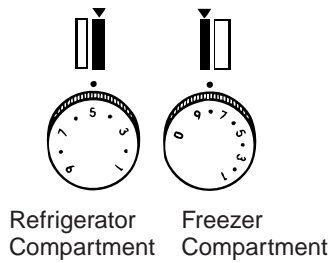

(or)

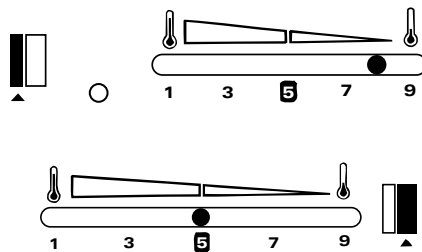

FREEZER COMPARTMENT	REFRIGERATOR COMPARTMENT

## 4 A SMALL AMOUNT OF FOOD IS STORED

Use this setting when food is to be stored at warmer temperatures.

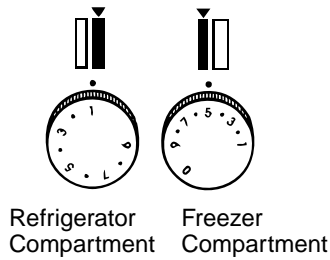

(or)

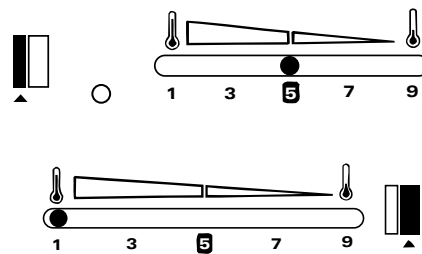

FREEZER COMPARTMENT	REFRIGERATOR COMPARTMENT

# UTILIZING THE INTERIOR SPACE

## 1 REFRIGERATOR COMPARTMENT SHELVES

Each shelf is adjustable, enabling space to be utilized without waste.

1. To remove shelf, lift the front end slightly, while unhooking it from the slot in the back.

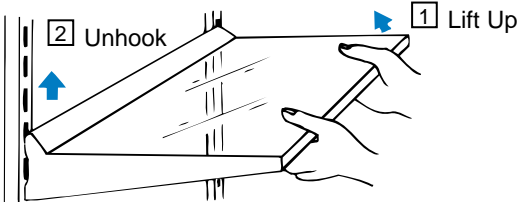

2. To install shelf, lift the front end and insert the hooks into the slots at desired height, and lower front end to lock in securely.

- 1 Insert Hooks
- 2 Lower Front

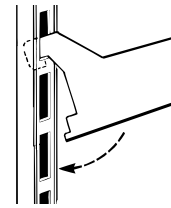

## 2 FREEZER COMPARTMENT SHELF

To remove shelf, pull forward and lift slightly.

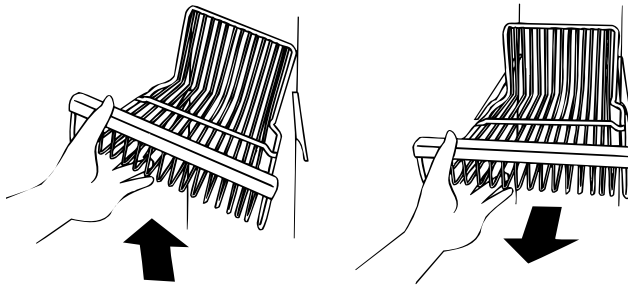

- 1 Push down on tab while lifting up on shelf.
- 2 Rotate shelf up, then pull to the right.

(or)

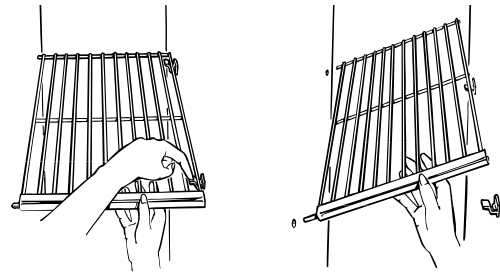

## 3 AIRTIGHT SNACK CASE (or) MEAT/SNACK CASE

Unwrapped foods can be stored in the airtight snack case without losing the unique moisture of food. For example, the snack case is best suited for storing foods such as cheese, bacon, hors d'oeuvres, jam, paste, etc.

- When the lever is set on high humidity, the case becomes airtight, preventing moisture from escaping into the refrigerator compartment. The airtight case allows food to be stored for relatively long periods of time without losing moisture content.

- When the lever is set on low humidity, the vent between the case and the refrigerator compartment opens, allowing air circulation. On this setting, foods can become dry. Therefore, this setting is appropriate for foods that do not require moisture.

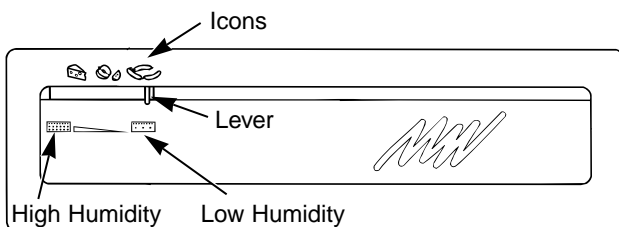

(or)

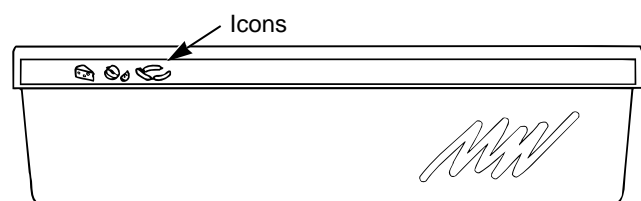

# UTILIZING THE INTERIOR SPACE (continued)

## 4 HIGH HUMIDITY VEGETABLE COMPARTMENT

This compartment is designed to maintain good internal airtightness, allowing vegetables to be stored without losing freshness. It is normal for water to accumulate in the compartment due to differences in temperature and vegetable moisture content. Vegetables should be stored in plastic or paper wrappings to prevent water accumulation.

To prevent vegetables from spoiling, drain water and wipe compartment dry if water accumulates.

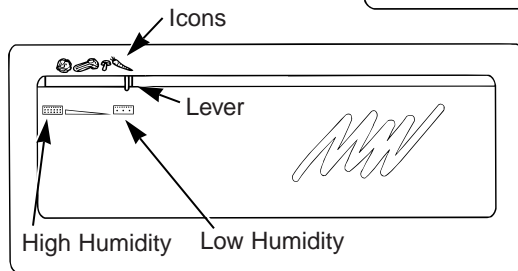
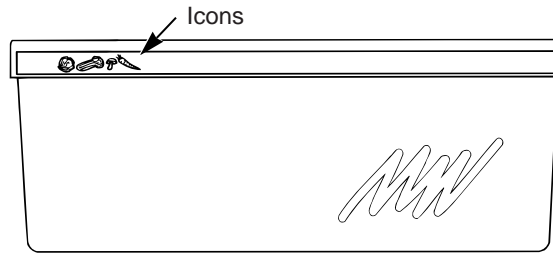
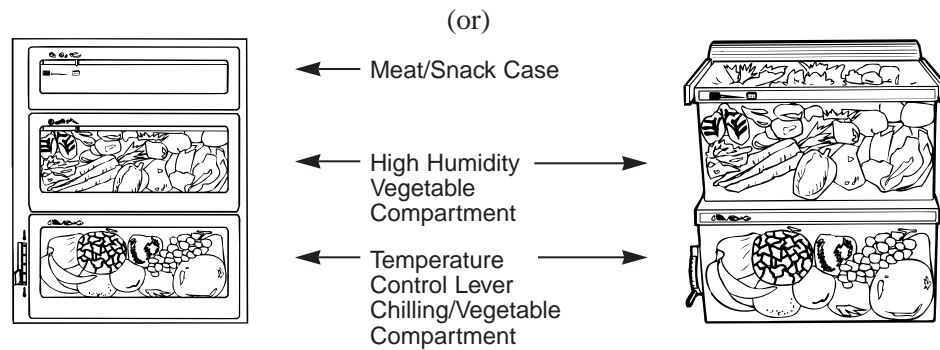

When lever is set on high humidity, the case becomes airtight, preventing moisture from escaping into the refrigerator compartment. The airtight case allows foods to be stored for relatively long periods of time without losing moisture content.

(or)

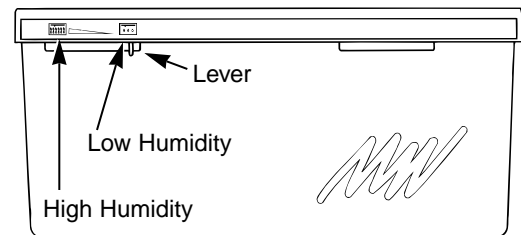

When lever is set on low humidity, the vent between the case and the refrigerator compartment opens, allowing air circulation. On this setting, foods can become dry. Therefore, this setting is appropriate for foods that do not require moisture.

# UTILIZING THE INTERIOR SPACE (continued)

## 5 CHILLING/VEGETABLE COMPARTMENT

For use as a chilling compartment, set lever to the lower position. Cold air will circulate from the freezer compartment and will be suitable for storing food at a lower temperature.

Frost may form if the lever is set at the lower position for a long period of time.

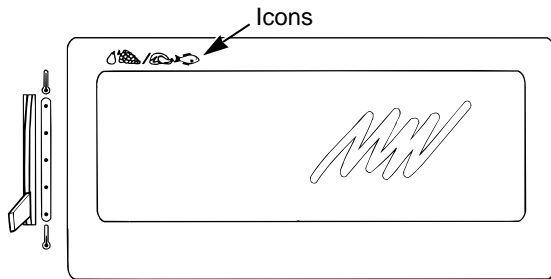
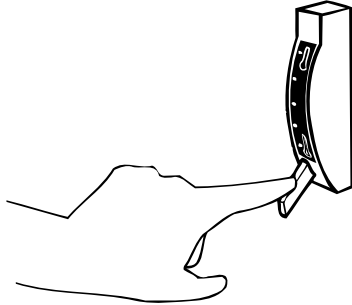

(or)

For use as a vegetable compartment, set lever to the upper position. Cold air from the freezer compartment will not circulate into this compartment and vegetables can be stored.

Set control to the upper position if room temperature is below 10°C. to prevent water dispenser tank from freezing.

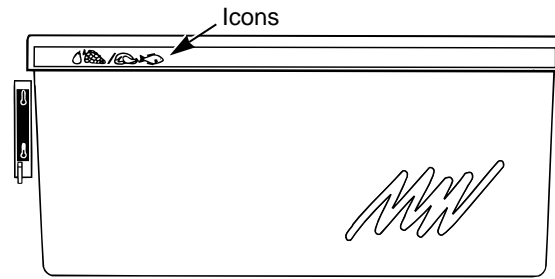
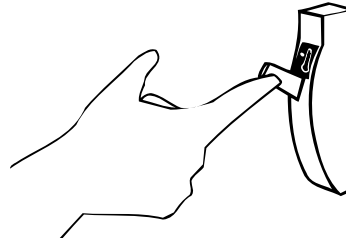

Operation

## 6 ADJUSTABLE HEIGHT DOOR POCKET

Both large and small items can be stored in this box-type shelf. The container can be removed from the door and conveniently carried to a table or counter.

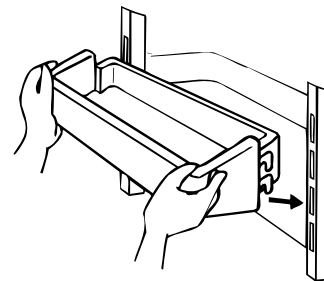

# ICEMAKING

## (1) ICE TRAY SHOULD BE FILLED UP TO THE ICE CUBE SEPARATOR

If water is filled above ice cube separator, the cubes will stick together.

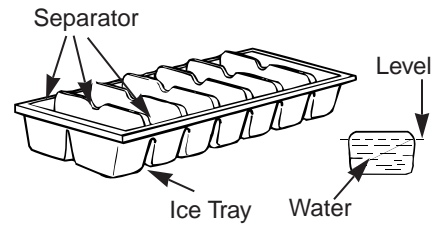

## (2) AFTER ICE IS MADE, TRANSFER ICE TO ICE BOX

When ice is completely formed, transfer ice cubes from the ice tray to the ice box.

- To remove ice cubes, simply twist tray as shown in figure.

**CAUTION:** If the ice box is wet, cubes will stick together. Ice box should not be used to make ice, since the box could break.

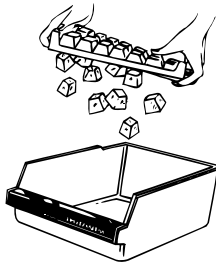

### CAUTION

**Do not touch food or metal containers in the freezer compartment with wet hands.**

- You may suffer from frostbite caused by the low temperature.



**DO NOT TOUCH**

## (3) A CONVENIENT ICEMAKER (NOT INCLUDED) CAN BE INSTALLED

(TFJ20JA, TFJ22JA & TFJ25PA MODELS)

An icemaker which can be bought separately can be installed in this refrigerator. An icemaker makes ice automatically, eliminating the chore of filling the ice tray and transferring the ice cubes.

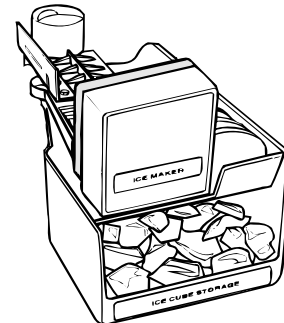

## (4) OPERATION OF ICEMAKER (AUTOMATIC ICE-MAKING APPARATUS)

(TPJ24BI MODEL ONLY)

GE Icemaker (automatic ice-making apparatus) does not require manual water supply. Following completion of installation of the water supply piping system, lower the arm switch to "ON." Ice is now automatically made and the icemaker will automatically shut off when the bucket is filled with set amount of ice.

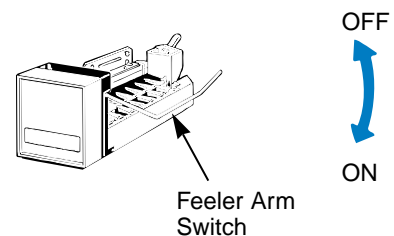

# STORAGE OF FOOD

## (1) STORAGE OF FOOD

When storing foods, place items requiring colder temperatures (meats, cakes, etc.) near the cold air inlet, while placing items which are not to be subjected to dewing or icing (vegetables, fruit, etc.) in the lower areas.

Beer and juices should be stored in the door pockets, while butter and cheeses should be stored in the upper portion of the door (astro-door type utility compartment) where the temperature is relatively high.

1. Provide space between items in the refrigerator. Packing items too densely will reduce circulation of cold air, reducing cooling.







2. If foods stored in the freezer are not sealed airtight, water condensation could occur on the surface of the refrigerator's cold walls and dampen contents by dewing. Therefore, when storing, use airtight containers or plastic wrap.

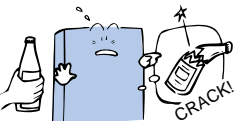

## (2) WARNINGS ABOUT FOOD STORAGE

1. Bottles should not be stored inside the freezer because they may break.
2. Do not store plasma or vaccines in this refrigerator. In addition, volatile or flammable substances should never be stored in refrigerators.
3. Avoid leaving the door open. Do not open and close the door unnecessarily.
4. Do not store hot foods without cooling them first.
5. Do not store ice cream in the door pocket.

⚠ DANGER	⚠ WARNING	⚠ WARNING	⚠ CAUTION
<p>Do not store bottles or cans in freezer compartment.</p>  <ul style="list-style-type: none"> <li>• Contents will freeze and broken glass may cause injuries.</li> </ul> <p style="text-align: center;"><b>NO BOTTLES</b></p>	<p>Flammable ether, benzene, alcohol, medicine, LP gas, etc., should not be stored.</p>  <ul style="list-style-type: none"> <li>• Danger of explosion.</li> </ul> <p style="text-align: center;"><b>DON'T STORE</b></p>	<p>Do not store medicine or scientific specimens in refrigerator.</p>  <ul style="list-style-type: none"> <li>• Items requiring strict temperature control should not be stored in a household refrigerator.</li> </ul> <p style="text-align: center;"><b>DON'T STORE</b></p>	<p>Do not store hot foods. Cool them first.</p>  <p style="text-align: center;"><b>FOODS SHOULD BE COOLED FIRST</b></p>

# WHAT TO KNOW ABOUT FROZEN FOODS

## (1) METHODS OF SELECTING AND USING STORE-BOUGHT FROZEN FOODS

There are approximately 3,000 varieties of frozen food on the market at the present time. Store-bought frozen foods are wholesome, high in nutritional value and easy to prepare. Spoilage or food poisoning are of no concern. The most attractive feature of frozen food is its longevity (1–3 months). As long as you have frozen items on hand in the freezer, it is easy to prepare a splendid meal on short notice, with minimal concern should unexpected guests drop in.

### • TIPS FOR SELECTION

1. Select items preserved in a showcase, indicating a temperature below  $-18^{\circ}\text{C}$ .
2. Select items with an approval label from the Japan Frozen Food Association.
3. Select items with the latest manufacturing date.
4. Select items with proper shape and that are frozen hard.
5. Select items without torn wrappings.
6. Avoid items with obscured view of contents due to excessive frosting. They may have been re-frozen.

### • TIPS FOR THAWING

1. Thaw only the amount needed. Only the needed portion should be thawed by breaking the selection into small pieces or cutting it with a saw.
2. Do not thaw completely. The correct stage for cooking is reached when edges become soft but the core is still frozen.
3. Food should be cooked as soon as it is thawed.
4. Use the appropriate thawing method prescribed for each particular food.

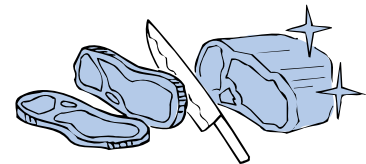
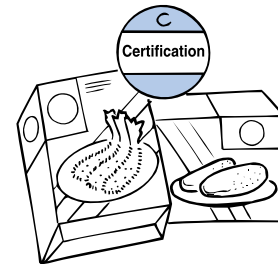
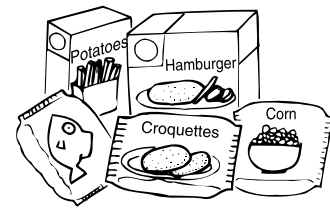

## (2) BASIC THINGS TO KNOW ABOUT HOME FREEZING

### • THE FUNDAMENTALS OF FREEZING

1. Food items should be fresh. Freshness is most important to ensure tasty frozen food.
2. Cool food before freezing. If a hot item is placed inside the freezer, the freezer will warm up, affecting other food items.
3. Always seal products in an airtight container or wrapping in order to prevent changes in food. In addition, liquids should be stored in containers with extra volume to accommodate expansion.
4. Freeze single servings measured according to the size of your family.
5. Arrange in thin packages and freeze quickly. The trick for good home freezing is “quick freezing,” which is why packaging should be thin.
6. Set freezer dial to HIGH cooling (9). Return dial to original (normal) setting after freezing is complete.
7. Door should be kept closed as much as possible.

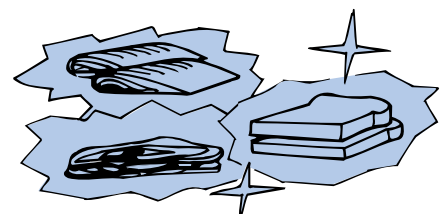
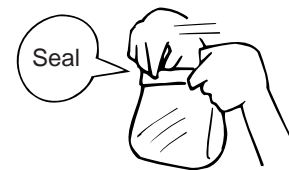



# CARE AND CLEANING OF REFRIGERATOR

## (1) REFRIGERATOR INTERIOR

Parts that can be removed should be washed. Dry parts before returning. Use a small amount of mild detergent if needed. (Detergent should be wiped clean.)

**CAUTION:** Use mild detergent and warm water to avoid damaging paint or plastic.

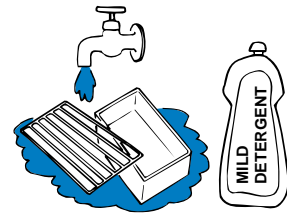

## (2) REFRIGERATOR EXTERIOR

Wipe off whenever exterior surfaces are dirty or wet. Apply suitable wax to the refrigerator exterior several times a year.

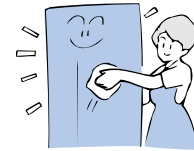

## (3) DOOR GASKET

The door gasket will deteriorate quickly if liquid food or juice are spilled on it. Clean the door gasket in the same way as refrigerator interior.



## (4) CONDENSER

Remove front grille when adjusting height of refrigerator or when cleaning the condenser.

1. To remove the grille, hold the bottom of grille and pull forward.
2. To install the grille, hold both ends of grille and push prongs into holes.

Vacuum once or twice a year, since dirt on the condenser will decrease efficiency, increase electricity consumption, and reduce cooling capacity of the refrigerator.

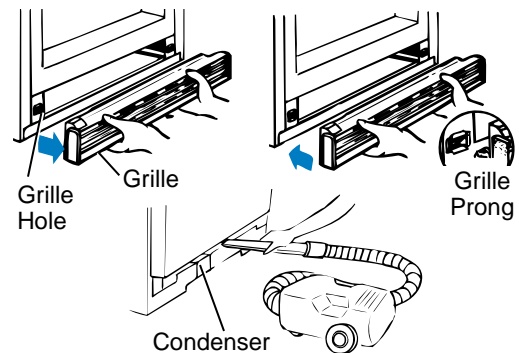

## (5) REPLACING THE LIGHT BULB

### FREEZER COMPARTMENT

Remove the lamp cover before replacing the bulb.

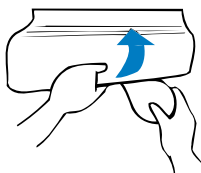

**NOTE:** On some models, a screw must be removed before removing the lamp cover.

### REFRIGERATOR COMPARTMENT (upper light bulb)

1. Pull out the 2 knobs or dials.
2. Remove cover by turning it upward or by pulling it outward.
3. Turn lamp to the left to remove and replace it.
4. Use only a 40W bulb.

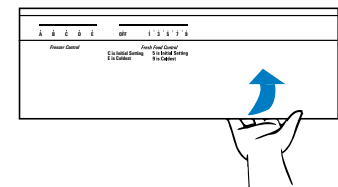

# SELF-DIAGNOSIS

## “Let’s Find Out On Our Own”

★ Indicates that the item’s self-diagnosis is difficult. To clarify, consult dealership where the unit was purchased.

### (1) NO COOLING

- **Is the electricity on?**
  1. Is power cord plugged in?
  2. Is fuse (breaker) blown?
  3. Is there a blackout?

★ **Is the compressor working?**

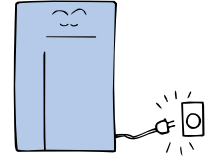

### (2) POOR COOLING

- **Is the air flow to the condenser adequate?**  
If the air flow is inadequate, cooling will not occur.
- **Is the door opened/closed frequently?**  
Cold air will escape if door openings/closings are frequent.
- **Is the temperature control dial set correctly?**  
Refer to page 14.
- ★ **Is interior fan of the refrigerator working?**  
If the fan is not working, cold air will not circulate and cooling will not occur.
- ★ **Is there a gap in the door?**  
If a gap exists, cold air will escape and cooling will not occur.
- ★ **Is frost built up too thick?**
- ★ **Is refrigerator being defrosted?**  
If timer is set to defrost, cooling will not occur.



### (3) NOISY

- **Is the floor firm?**  
If the floor is unsteady, noise level will increase.
- **Are there any trays leaning against the side of the refrigerator?** These trays may produce a resounding noise.

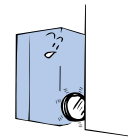

### (4) WATER ACCUMULATION INSIDE

- **Are there any food items with high water content?**  
Refer to page 22 for food storage.



### (5) BAD ODOR

- **Is interior of the refrigerator clean?**  
A dirty interior is the main source of odor.
- **Are there any foods with a strong odor?**  
These can produce a bad combination odor with other food odors.



### (6) FOODS FREEZE IN REFRIGERATOR

- **Is the setting of the temperature control dial correct?**  
Refer to page 14.
- **Are foods stored properly?**  
If cold air hits them directly, some foods may freeze.

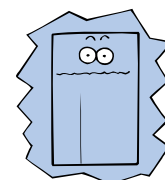

# WARRANTY AND AFTER-SERVICE (PLEASE READ CAREFULLY)

**A WARRANTY GUIDE, THE “WARRANTY NOTE,” FOR THE GE FREEZER/REFRIGERATOR WHICH YOU HAVE JUST PURCHASED IS ATTACHED AS A SEPARATE BOOKLET TO THIS OPERATIONS GUIDE.**

**SINCE IT IS AN IMPORTANT BOOKLET FOR AFTER-SERVICE, ETC., KEEP IT IN A SAFE PLACE ALONG WITH THIS BOOKLET.**

## REQUESTING REPAIR WORK

- **WARRANTY PERIOD—One year from the date of purchase.**

The freezer cycle coolant system has a five-year warranty.

If the malfunction cannot be corrected after following the instructions on page 33, a service call for repair work should be placed to the dealership where the unit was purchased. Warranty applies only to repair of the appliance hardware itself and to no other items such as food, etc.

- **DURING WARRANTY PERIOD:**

Please present the “WARRANTY NOTE” when repair work is performed. In accordance with the “WARRANTY NOTE,” the dealership where the unit was purchased will dispatch a repairman for the job. If you do not contact the dealership, please contact GE APPLIANCES JAPAN, INC.

The following information is to be reported to the dealer or to this company:

1. Customer’s name, address and telephone number
2. Model of refrigerator
3. Details of problem

Refer to the chapter on “Self-Diagnosis” in this OPERATIONS GUIDE and provide answers to the serviceman’s questions.

When a serviceman visits, show him the “WARRANTY NOTE” attached to this guide.

## MINIMUM WARRANTY PERIOD FOR FUNCTION-MAINTENANCE PARTS

**The minimum warranty period (for parts that are required to maintain performance function) is 9 years from the last manufacturing date.**

This period is established in accordance with MITI directives.

## LARGE ELECTRICAL APPLIANCES “WARRANTY NOTE”

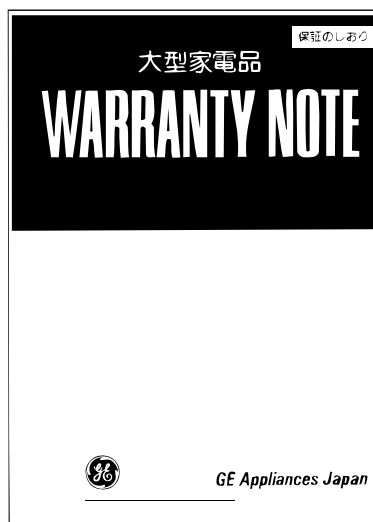

# WARRANTY AND AFTER-SERVICE (PLEASE READ CAREFULLY)



**THIS MARKING ON A REFRIGERATOR DENOTES THAT IT IS A "PRODUCT THAT MEETS THE '96 SPECIFIED FREON REGULATION."**

Refrigerators use Freon for their freezing apparatus and heat insulators. Freon is non-flammable and not harmful to the human body directly. Furthermore, it possesses excellent properties which have made it one of the most useful chemical substances and contributed to the development of modern civilization.

In its capacity as a cleaning agent, propellant, and for its use in refrigerators, however, it is thought to have caused the depletion of the atmospheric ozone layer. The decision was made to cease worldwide production of this substance completely and to switch to a substance which has less impact on the ozone layer.

<p><b>LOVING CARE INSPECTION</b></p>	<b>• INSPECTION OF OLDER MODEL REFRIGERATORS</b>	
	<p><b>Are these symptoms present?</b></p> <ul style="list-style-type: none"> <li>• Unusually hot power cord and plug</li> <li>• Damaged power cord</li> <li>• Burning smell</li> <li>• Accumulation of water under refrigerator</li> <li>• Electric shock</li> <li>• Other malfunction and breakdown</li> </ul>	<p><b>Request</b></p> <p>Unplug the power plug to prevent breakdown or accident and consult the dealership where the unit was purchased for inspection or repair.</p>

<b>USEFUL INFORMATION FOR REQUESTING SERVICE</b>	Date Purchased	Year	Month	Day	Model # TFJ20JA, TFJ22JA, TFJ24BI, TFJ25PA
	Dealership	Phone (    )			

WARRANTY BUSINESS INFORMATION CENTER IN JAPAN

## GE APPLIANCES JAPAN, INC.

Marumasumaricho Bldg. 4F  
3-3 Maricho, Chiyoda-Ku  
Tokyo, Japan 102

TEL: (03) 3265-5570 (Main)  
FAX: (03) 3265-5131

<p>DEALERSHIP</p>
-------------------