



ELECTRIC AND GAS DRYERS

Use & Care Guide

Table of Contents	2
-------------------------	---

Models
3RLER5437, 3RLGR5437,
3RLEC8646, 3RLEQ8000,
3RLEC8600, 3RLEQ8033

TABLE OF CONTENTS

DRYER SAFETY	2	DRYER CARE	9
DRYER DISPOSAL	4	Cleaning the Dryer Location.....	9
PARTS AND FEATURES	5	Cleaning the Lint Screen.....	9
CHECKING YOUR VENT	6	Cleaning the Dryer Interior.....	9
DRYER USE	6	Removing Accumulated Lint.....	9
Starting Your Dryer.....	6	Regular Servicing.....	10
Stopping and Restarting.....	7	Vacation and Moving Care.....	10
Drying, Cycle and Temperature Tips.....	7	TROUBLESHOOTING	10
Cycle Descriptions.....	7	ASSISTANCE OR SERVICE	12
Additional Features.....	8		
Drying Rack (optional).....	8		

DRYER SAFETY

Your safety and the safety of others are very important.

We have provided many important safety messages in this manual and on your appliance. Always read and obey all safety messages.



This is the safety alert symbol.

This symbol alerts you to potential hazards that can kill or hurt you and others.

All safety messages will follow the safety alert symbol and either the word "DANGER" or "WARNING."

These words mean:

⚠ DANGER

You can be killed or seriously injured if you don't immediately follow instructions.

⚠ WARNING

You can be killed or seriously injured if you don't follow instructions.

All safety messages will tell you what the potential hazard is, tell you how to reduce the chance of injury, and tell you what can happen if the instructions are not followed.

WARNING: For your safety, the information in this manual must be followed to minimize the risk of fire or explosion, or to prevent property damage, personal injury, or death.

- Do not store or use gasoline or other flammable vapors and liquids in the vicinity of this or any other appliance.
- **WHAT TO DO IF YOU SMELL GAS:**
 - Do not try to light any appliance.
 - Do not touch any electrical switch; do not use any phone in your building.
 - Clear the room, building, or area of all occupants.
 - Immediately call your gas supplier from a neighbor's phone. Follow the gas supplier's instructions.
 - If you cannot reach your gas supplier, call the fire department.
- Installation, service, or conversions for use on other gas supplies must be performed by a qualified installer, service agency, or the gas supplier.

IMPORTANT SAFETY INSTRUCTIONS

WARNING: To reduce the risk of fire, electric shock, or injury to persons when using the dryer, follow basic precautions, including the following:

- Read all instructions before using the dryer.
- Gas dryers should only be installed in a room if the room meets the appropriate ventilation requirements specified in the national installation regulations. Make sure the room containing the dryer has an adequate air supply for gas combustion and/or drying operation. A window or equivalent means of ventilation must be opened in the room when the dryer is in use (an equivalent form of opening includes an adjustable louvre, hinged panel, or other means of ventilation that opens directly to outside air).
- Keep a minimum clearance of 10 cm (4 in.) between the rear of the dryer and any wall.
- The operation of this appliance may affect the operation of other types of gas appliances which take their air supply for safe combustion from the same room. There has to be adequate ventilation to replace exhausted air and thus avoid the back-flow of gases into the room from appliances burning other fuels, including open fires, when operating the tumble dryer. If in doubt, consult the appliance manufacturers.
- Do not obstruct the air supply to the dryer (see Installation Instructions for minimum clearances).
- Do not place items exposed to cooking oils in your dryer. Items contaminated with cooking oils may contribute to a chemical reaction that could cause a load to catch fire.
- Do not dry articles that have been previously cleaned in, washed in, soaked in, or spotted with gasoline, dry-cleaning solvents, cooking oils, or other flammable, or explosive substances as they give off vapours that could ignite or explode.
- Do not allow children to play on or in the dryer. Close supervision of children is necessary when the dryer is used near children.
- Before the dryer is removed from service or discarded, remove the doors to the drying compartment.
- Do not reach into the dryer if the drum is moving. A door switch is fitted for your safety.
- Do not install or store the dryer where it will be exposed to the weather.
- Do not tamper with controls.
- Do not continue to use this appliance if it appears to be faulty.
- Do not repair or replace any part of the dryer or attempt any maintenance unless specifically recommended in this Use and Care Guide. Repairs and servicing should only be carried out by competent service personnel.
- Do not use fabric softeners or products to eliminate static unless recommended by the manufacturer of the fabric softener or product.
- Do not use heat to dry articles containing foam rubber or similarly textured rubber-like materials.
- Always use the cool-down period at end of drying cycle to avoid a heat build-up in stored clothes.
- Clean dryer lint screen before or after each load. Do not operate dryer without lint screen in place.
- Keep area around the exhaust and inlet openings and adjacent surrounding areas free from the accumulation of lint, dust, and dirt.
- The interior of the dryer and exhaust vent should be cleaned periodically by qualified service personnel.
- See Installation Instructions for earthing instructions.
- If the supply cord is damaged, it must be replaced by the manufacturer or its service agent or a similarly qualified person in order to avoid a hazard.

SAVE THESE INSTRUCTIONS

DRYER DISPOSAL



This appliance is marked according to the European directive 2002/ 96/ EC on Waste Electrical and Electronic Equipment (WEEE).

By ensuring this product is disposed of correctly, you will help prevent potential negative consequences for the environment and human health, which could otherwise be caused by inappropriate waste handling of this product.

The symbol on the product, or on the documents accompanying the product, indicates that this appliance may not be treated as household waste. Instead it shall be handed over to the applicable collection point for the recycling of electrical and electronic equipment.

Disposal must be carried out in accordance with local environmental regulations for waste disposal.

For more detailed information about treatment, recovery and recycling of this product, please contact your local city office, your household waste disposal service or the shop where you purchased the product.

PARTS AND FEATURES

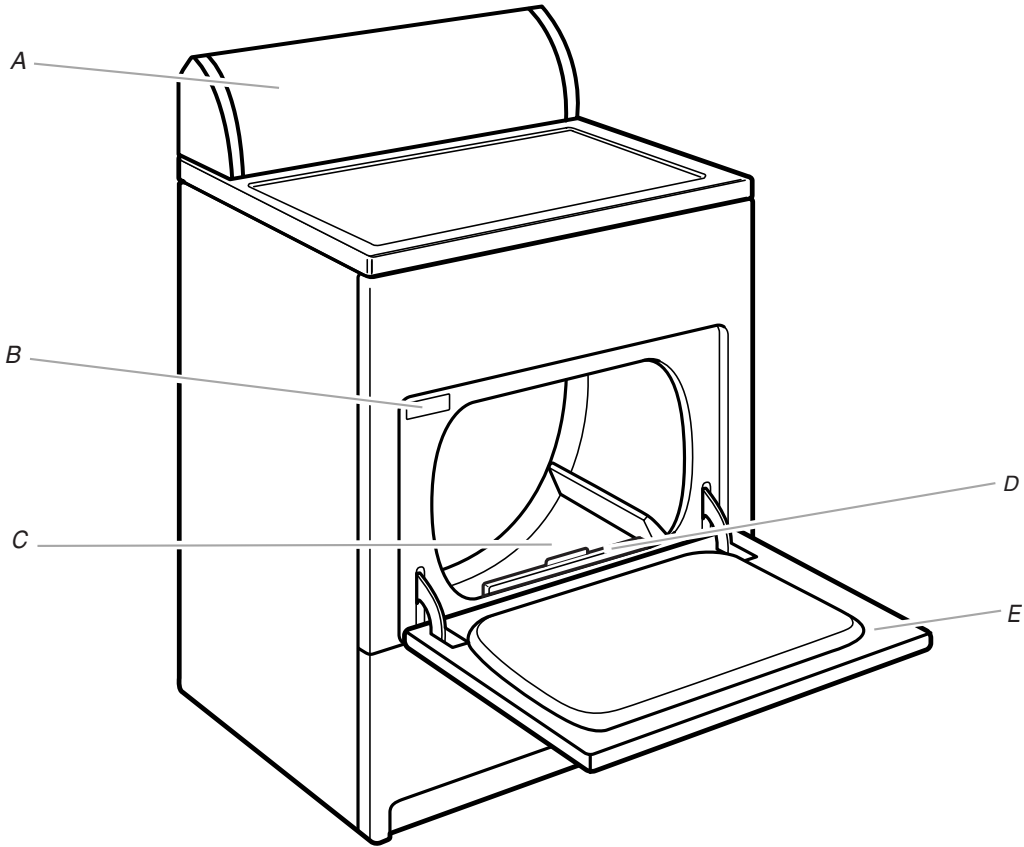

- A. Control panel
- B. Model and serial number label
- C. Dryer drum
- D. Lint screen
- E. Wide-opening door

Additional features your dryer may have

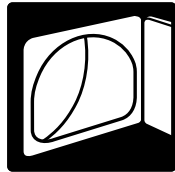

- End of Cycle Signal selector
- Wrinkle Guard selector
- Automatic Dry sensor

- Optional purchase**
- Drying rack

Control Panel

Quiet Dry Commercial Quality • Super Capacity Plus • 8 Cycles • 4 Temperatures **Heavy Duty Series 8**

CHECKING YOUR VENT

Your dryer must be properly installed and vented to achieve maximum drying efficiency and shorten drying times. Use the minimum recommended installation clearances found in the Installation Instructions. Refer to the Installation Instructions for more information.

⚠ WARNING



Fire Hazard

- Use a heavy metal vent.
- Do not use a plastic vent.
- Do not use a metal foil vent.
- Failure to follow these instructions can result in death or fire.

If the dryer is not properly installed and vented, it will not be covered under the warranty.

NOTE: Service calls caused by improper venting will be paid for by the customer, whether it was a paid installation or self-installed.

1. Do not use plastic vent or metal foil vent. Use 10.2 cm (4") metal or flexible metal vent. Do not kink or crush flexible metal vent. It must be completely extended to allow adequate exhaust air to flow. Check vent after installation. Refer to the Installation Instructions for proper length requirements of vent.
2. Use a 10.2 cm (4") exhaust hood.

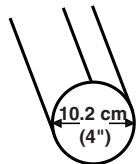

3. Use the straightest path possible when routing the vent.

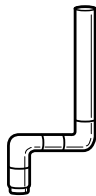

Good



Better

4. Use clamps to seal all joints. Do not use duct tape, screws or other fastening devices that extend into the interior of the vent to secure vent.
5. Clean exhaust vent periodically, depending on use, but at least every 2 years, or when installing your dryer in a new location. When cleaning is complete, be sure to follow the Installation Instructions supplied with your dryer for final product check.

DRYER USE

Starting Your Dryer

⚠ WARNING



Explosion Hazard

Keep flammable materials and vapors, such as gasoline, away from dryer.

Do not dry anything that has ever had anything flammable on it (even after washing).

Failure to follow these instructions can result in death, explosion, or fire.

⚠ WARNING



Fire Hazard

No washer can completely remove oil.

Do not dry anything that has ever had any type of oil on it (including cooking oils).

Items containing foam, rubber, or plastic must be dried on a clothesline or by using an Air Cycle.

Failure to follow these instructions can result in death or fire.

This booklet covers several different models. Your dryer may not have all of the cycles and features described.

Before using your dryer, wipe the dryer drum with a damp cloth to remove dust from storing and shipping.

1. Clean lint screen before each load. See "Cleaning the Lint Screen."
2. Load clothes loosely into the dryer and close the door. Do not pack the dryer. Allow space for clothes to tumble freely. Maximum clothing load (cotton fabrics) is 9.1 kg (20 lbs).



3. Turn the Cycle Control knob to the recommended cycle for the type of load being dried. See “Drying, Cycle and Temperature Tips.”
4. Select a temperature setting on models with a temperature selector. The cycle descriptions include temperature setting suggestions.
NOTE: The temperature selector is part of the Cycle Control knob on some models.
5. Select the End of Cycle Signal, if available. The signal is helpful when drying permanent press or synthetics. Promptly remove these items from the dryer at the end of the cycle to prevent wrinkles.
6. Select Wrinkle Guard, if available.
7. Press PUSH TO START. Your gas dryer has an electronic ignition system for the burner which is fully automatic; no action is needed by the user (there is no pilot light).
NOTE: Your dryer stops automatically when a cycle ends.

How Automatic Drying Works

During the Auto Dry Cycle, the exhaust temperature of the dryer determines the drying time and dryness levels. A thermostat signals the Cycle Control Knob when to move into Cool Down. The drying time for an Auto Dry Cycle depends on load type and load size. When drying a large or heavy load, the Cycle Control Knob may take a long time before it begins to advance into Cool Down. The Auto Dry Cycle takes the guesswork out of drying time and enhances fabric care. The amount of time that is displayed is the estimated time remaining in the cycle.

Stopping and Restarting

You can stop your dryer anytime during a cycle.

To stop your dryer

Open the dryer door or turn the Cycle Control knob to OFF.

NOTE: The Cycle Control knob should point to an Off area when the dryer is not in use.

To restart your dryer

1. Close the door.
2. Select a new cycle and temperature (if desired).
3. Press PUSH TO START.

Drying, Cycle and Temperature Tips

Select the correct cycle and temperature for your load.

Cool Down tumbles the load without heat during the last few minutes of all cycles to make the load easier to handle.

Drying tips

- Follow care label directions when they are available.
- If desired, add a fabric softener sheet. Follow package instructions.
- To reduce wrinkling, remove the load from the dryer as soon as tumbling stops. This is especially important for permanent press, knits and synthetic fabrics.

Cycle and temperature tips

- Use a Hot (or High) Heat setting for drying heavyweight items such as towels and work clothes.
- Use a Medium Heat setting for drying medium weight items such as sheets, underwear, permanent press fabrics and some knits.
- Use a Low Heat setting for drying lightweight items such as lingerie, blouses, dresses and some knits.

- Use a no-heat (air) setting for rubber, plastic or heat-sensitive fabrics.
- Line dry bonded or laminated fabrics.

NOTE: If you have questions about drying temperatures for various loads, refer to the care label directions. If you are unsure of the temperature to select for a load, select a lower setting rather than a higher setting.

Cycle Descriptions

This manual covers several different models. Your dryer may vary from the model shown, and may not have all of the cycles and features described.

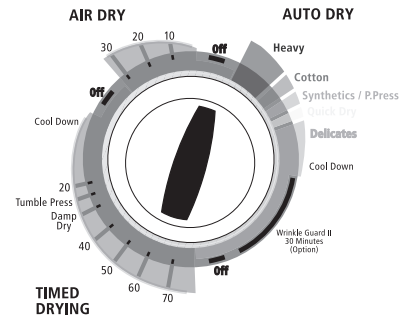

Cycle Control knob

Auto Dry cycle

Use your Automatic cycle to dry most loads. Your dryer has a control that senses the moisture level in the load and shuts off when the load reaches the selected dryness.

- Select the temperature from the temperature selector based on the fabrics in your load.

After drying a load, check the dryness.

- If the load is drier than you like, select a setting closer to Delicates the next time you dry a similar load.
- If a load is not as dry as you like, complete drying using a Timed cycle. Select a setting closer to Heavy the next time you dry a similar load.

NOTE: Drying time varies with an Automatic cycle. The type of fabric, the size of the load, and the dryness selected affect drying time. See “Drying, Cycle and Temperature Tips.”

Timed Drying cycle(s)

Use Timed Drying for heavyweight and bulky items, such as bedspreads and work clothes or large loads that require a long drying time. Set the temperature selector, if available, to Hot (or High) Heat.

On some models, you may use the Timed Drying cycle for lightweight items such as lingerie or knits. Set the temperature selector, if available, based on the fabrics in your load.

NOTE: Use your Timed Drying cycle to complete drying if items are still damp after the Automatic cycle.

Air Fluff or Air Dry cycles

Use the Air Fluff or Air Dry cycle for items that require drying without heat such as rubber, plastic, or heat-sensitive fabrics. Set the Cycle Control knob to Air Fluff or Air Dry. This chart shows examples of items that can be dried using the Air Fluff or Air Dry cycle.

Type of Load	Air Fluff or Air Dry cycle*
Foam rubber—pillows, padded bras, stuffed toys	20 - 30
Plastic—Shower curtains, tablecloths	20 - 30
Rubber-backed rugs	40 - 50
Olefin, polypropylene, sheer nylon	10 - 20

*(Minutes). Reset cycle to complete drying if needed.

When using Air Fluff or Air Dry

- Check to see that coverings are securely stitched.
- Shake and fluff pillows by hand periodically during cycle.
- Dry item completely. Foam rubber pillows are slow to dry.

Additional Features

This manual covers several different models. Your dryer may not have all of the features described.

Heavy

Select this setting to evenly dry large or heavy items such as thick cotton bath towels or robes. Set the Temperature selector, if available, to Hot (or High) Heat.

Cotton

Select this setting to thoroughly dry heavy items such as sheets, mattress pads and quilts, or a load of towels. Set the Temperature selector, if available, to Hot (or High) Heat.

Synthetics/Perm Press

Select this cycle to dry medium to lightweight synthetic or no-iron items such as shirts, blouses or dresses. Choose a Medium Heat setting if available.

Quick Dry

Use this cycle for drying small loads or loads that need a short drying time. Choose a Hot (or High) or Medium Heat setting depending on the type of fabrics being dried.

Delicates

Select this option to dry small loads or lightweight items. Set the Temperature selector, if available, to Low or Heat.

TUMBLE PRESS setting

Select this setting to remove wrinkles from such items as clothing packed in a suitcase or items wrinkled from being left in the dryer too long. Set the Temperature selector, if available, to Medium or Low Heat depending on the fabrics in your load.

Damp Dry

Select this setting to dry items to a damp level, or to dry items that do not require an entire drying cycle. Damp dry items such as jeans (to prevent stiffness) or cotton clothing (to make pressing easier). If your model has a Temperature selector, choose a temperature setting based on the fabrics in your load.

Wrinkle Guard II

When you are unable to remove a load from the dryer as soon as it stops, wrinkles can form. The Wrinkle Guard II feature periodically tumbles, rearranges and fluffs the load for up to 30 minutes without heat to avoid wrinkles. Press the Wrinkle Guard ON button to enable the Wrinkle Guard II feature. A signal will sound periodically when the Wrinkle Guard II feature is on if the End of Cycle Signal is selected. The signal and the tumbling will end when you open the dryer door, or when you turn the Cycle Control knob to Off.

End of Cycle Signal

- The End of Cycle signal sounds when a cycle is complete. If your End of Cycle signal is selectable, the signal will sound only if set to On.
- If the Wrinkle Guard II feature is on, the signal sounds every few minutes. The signal stops when you open the door or turn the Cycle Control knob to Off.

Drying Rack (optional)

The drying rack is useful for machine drying items you would not necessarily want to tumble dry or that you would normally line dry (for example, tennis shoes, pillows, stuffed toys).

If your model does not have a drying rack, you can order one by contacting the dealer from whom you purchased your dryer.

To use the drying rack

1. Slide rear pegs into the dimples on the back wall of the dryer. Lower the front legs to rest on the dryer opening.



2. Put the wet items on top of the rack. Leave space between the items so air can reach all the surfaces. Close the door.
NOTE: Do not allow items to hang over the edge of the rack.
3. Select cycle and temperature to match the fabrics in your load. Items containing foam, rubber, or plastic must be dried on a clothesline or by using an air cycle. Refer to the following table.
4. Press PUSH TO START. Reset cycle to complete drying, if needed.

NOTE: The rack must be removed for normal tumbling. Do not use the automatic cycle with the drying rack.

Rack Dry	Cycle	Temp	Time*
Wool Sweaters Block to shape and lay flat on the rack	Timed	Low	60
Stuffed toys or pillows Cotton or polyester fiber filled	Timed	Low	60
Stuffed toys or pillows Foam rubber filled	Air (no heat)	None	90
Sneakers or canvas shoes	Air (no heat)	None	90

*(Minutes). Reset cycle to complete drying if needed.

DRYER CARE

Cleaning the Dryer Location

Keep dryer area clear and free from items that would obstruct the flow of combustion and ventilation air.

⚠ WARNING



Explosion Hazard

Keep flammable materials and vapors, such as gasoline, away from dryer.

Place dryer at least 46 cm (18 inches) above the floor for a garage installation.

Failure to do so can result in death, explosion, or fire.

Cleaning the Lint Screen

Every load cleaning

The lint screen is located in the door of the dryer. Clean the lint screen before each load. A screen blocked by lint can increase drying time.

To clean

1. Pull the lint screen toward you. Roll lint off the screen with your fingers. Do not rinse or wash screen to remove lint. Wet lint is hard to remove.

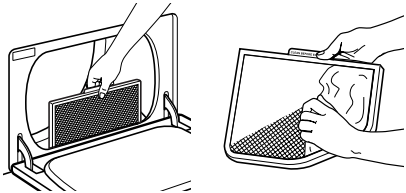

2. Push the lint screen firmly back into place.

IMPORTANT:

- Do not run the dryer with the lint screen loose, damaged, blocked, or missing. Doing so can cause overheating and damage to both the dryer and fabrics.
- If lint falls off the screen into the dryer during removal, check the exhaust hood and remove the lint. See "Checking Your Vent."

As needed cleaning

Laundry detergent and fabric softener residue can build up on the lint screen. This buildup can cause longer drying times for your clothes, or cause the dryer to stop before your load is completely dry. The screen is probably clogged if lint falls off the screen.

Clean the lint screen with a nylon brush every 6 months, or more frequently if it becomes clogged due to a residue buildup.

To wash

1. Roll lint off filter using your fingers.
2. Wet both sides of lint screen with hot water.
3. Wet a nylon brush with hot water and liquid detergent. Scrub lint screen with the brush to remove residue buildup.

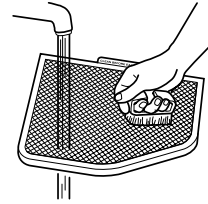

4. Rinse screen with hot water.
5. Thoroughly dry lint screen with a clean towel. Insert lint screen back into dryer.

Cleaning the Dryer Interior

To clean dryer drum

1. Make a paste with powdered laundry detergent and very warm water.
2. Apply paste to a soft cloth.

OR

Apply a liquid, nonflammable household cleaner to the stained area and rub with a soft cloth until all excess dye is removed.

3. Wipe drum thoroughly with a damp cloth.
4. Tumble a load of clean cloths or towels to dry drum.

NOTE: Garments that contain unstable dyes, such as denim blue jeans or brightly colored cotton items, may discolor the dryer interior. These stains are not harmful to your dryer and will not stain future loads of clothes. Dry unstable dye items inside out to prevent dye transfer.

Removing Accumulated Lint

From Inside the Dryer Cabinet

Lint should be removed every 2 years, or more often, depending on dryer usage. Cleaning should be done by a qualified person.

From Inside the Exhaust Vent

Lint should be removed every 2 years, or more often, depending on dryer usage.

If you have any questions or comments, please call a designated Whirlpool service company.

Regular Servicing

To keep your dryer operating at highest efficiency, regular servicing by a designated Whirlpool service technician is recommended. For normal use, this servicing should be at 12 monthly intervals. For heavy-duty usage, this interval should be reduced accordingly.

Vacation and Moving Care

Vacation care

Operate your dryer only when you are at home. If you will be on vacation or not using your dryer for an extended period of time, you should:

1. Unplug dryer or disconnect power.
 2. If you have a gas dryer, close shutoff valve in gas supply line.
 3. Clean lint screen. See "Cleaning the Lint Screen."
-

Moving care - Electric Dryers

For power supply cord-connected dryers:

1. Unplug the power supply cord.
 2. Make sure leveling legs are secure in dryer base.
 3. Use masking tape to secure dryer door.
-

⚠ WARNING



Electrical Shock Hazard

Disconnect power before servicing.

Replace all parts and panels before operating.

Failure to do so can result in death or electrical shock.

For direct-wired dryers:

1. Disconnect power.
 2. Disconnect wiring.
 3. Make sure leveling legs are secure in dryer base.
 4. Use masking tape to secure dryer door.
-

Moving care - Gas Dryers

1. Unplug the power supply cord.
 2. Close shutoff valve in gas supply line.
 3. Disconnect gas supply line pipe and remove fittings attached to dryer pipe.
 4. Cap the open fuel supply line.
 5. Make sure leveling legs are secure in dryer base.
 6. Use masking tape to secure dryer door.
-

TROUBLESHOOTING

First try the solutions suggested here and possibly avoid the cost of a service call...

Dryer Operation

Dryer will not run

- **Has a household fuse blown, or has a circuit breaker tripped?**
There may be 2 household fuses or circuit breakers for the dryer. Check to make sure both fuses are intact and tight, or that both circuit breakers have not tripped. Replace the fuse or reset the circuit breaker. If the problem continues, call an electrician.
 - **Is the correct power supply available?**
Electric dryers require 240 volt power supply. Check with a qualified electrician.
 - **Was a regular fuse used?**
Use a time-delay fuse.
 - **Is the dryer door firmly closed?**
 - **Was the Push to Start button firmly pressed?**
-

No heat

- **Has a household fuse blown, or has a circuit breaker tripped?**
Electric dryers use 2 household fuses or circuit breakers. The drum may be turning, but you may not have heat. Replace the fuse or reset the circuit breaker. If the problem continues, call an electrician.
 - **For gas dryers, is the valve open on the supply line?**
-

Unusual sounds

- **Has the dryer had a period of non-use?**
If the dryer hasn't been used for a while, there may be a thumping sound during the first few minutes of operation.
 - **Is a coin, button, or paper clip caught between the drum and front or rear of the dryer?**
Check the front and rear edges of the drum for small objects. Clean out pockets before laundering.
-

- **Is it a gas dryer?**
The gas valve clicking is a normal operating sound.
- **Are the four legs installed, and is the dryer level front to back and side to side?**
The dryer may vibrate if not properly installed. See the Installation Instructions.
- **Is the clothing knotted or balled up?**
When balled up, the load will bounce, causing the dryer to vibrate. Separate the load items and restart the dryer.
- **Is it a gas dryer?**
The gas valve clicking is a normal operating sound.

Timer does not noticeably advance

- **Is the dryer set to Timed or Air Dry?**
The timer moves slowly and continuously for the time setting.
- **Is the dryer set to Automatic Drying?**
The timer moves only when the clothing is mostly dry. See "How Automatic Drying Works" in "Dryer Use."

Dryer Results

Clothes are not drying satisfactorily, drying times are too long, or load is too hot

- **Is the lint screen clogged with lint?**
Lint screen should be cleaned before each load.

! WARNING



Fire Hazard

Use a heavy metal vent.
Do not use a plastic vent.
Do not use a metal foil vent.
Failure to follow these instructions can result in death or fire.

- **Is the exhaust vent or outside exhaust hood clogged with lint, restricting air movement?**
Run the dryer for 5-10 minutes. Hold your hand under the outside exhaust hood to check air movement. If you do not feel air movement, clean exhaust system of lint or replace exhaust vent with heavy metal or flexible metal vent. See the Installation Instructions.
- **Are fabric softener sheets blocking the grille?**
Use only one fabric softener sheet, and use it only once.

- **Is the exhaust vent the correct length?**
Check that the exhaust vent is not too long or has too many turns. Long venting will increase drying times. See the Installation Instructions.
- **Is the exhaust vent diameter the correct size?**
Use 4" (10.2 cm) diameter vent material.

! WARNING



Explosion Hazard

Keep flammable materials and vapors, such as gasoline, away from dryer.

Place dryer at least 18 inches (46 cm) above the floor for a garage installation.

Failure to do so can result in death, explosion, or fire.

- **Is the dryer located in a room with temperature below 45°F (7°C)?**
Proper operation of dryer cycles requires temperatures above 45°F (7°C).
- **Is the dryer located in a closet?**
Closet doors must have ventilation openings at the top and bottom of the door. The sides and front of the dryer require a minimum of 1" (2.5 cm) of airspace, and the rear of the dryer requires 5½" (14 cm). See the Installation Instructions.
- **Has an air dry cycle been selected?**
Select the right cycle for the types of garments being dried.
- **Is the load too large and heavy to dry quickly?**
Separate the load to tumble freely.

Cycle time too short

! WARNING

Excessive Weight Hazard

Use two or more people to move and install dryer.

Failure to do so can result in back or other injury.

- **Is the automatic cycle ending early?**
The load may not be contacting the sensor strips. Level the dryer.

Change the dryness level setting on Automatic Cycles. Increasing or decreasing the dryness level will change the amount of drying time in a cycle.

Lint on load

- **Is the lint screen clogged?**

Lint screen should be cleaned before each load.

Stains on load or drum

- **Was dryer fabric softener properly used?**

Add dryer fabric softener sheets at the beginning of the cycle. Fabric softener sheets added to a partially dried load can stain your garments.

Drum stains are caused by dyes in clothing (usually blue jeans). This will not transfer to other clothing.

Loads are wrinkled

- **Was the load removed from dryer at the end of the cycle?**

- **Was the dryer overloaded?**
Dry smaller loads that can tumble freely.

Odors

- **Have you recently been painting, staining or varnishing in the area where your dryer is located?**

If so, ventilate the area. When the odors or fumes are gone from the area, rewash and dry the clothing.

- **Is the electric dryer being used for the first time?**

The new electric heating element may have an odor. The odor will be gone after the first cycle.

ASSISTANCE OR SERVICE

Before calling for assistance or service, please check the "Troubleshooting" section. It may save you the cost of a service call. If you still need help, follow these instructions.

If you need assistance or service

If your problem is not due to any of the items listed in the "Troubleshooting" section, contact the dealer from whom you purchased the dryer, or a designated Whirlpool service company.

When calling, please know the purchase date, and the complete model and serial number of your appliance. This information will help us better respond to your request.

For further assistance

If you need further assistance, you can write or call with any questions or concerns at:

Whirlpool UK Ltd.
209 Purley Way
Croydon
CR9 4RY
U.K.
Telephone: 0208 649 5000