

use & care guide

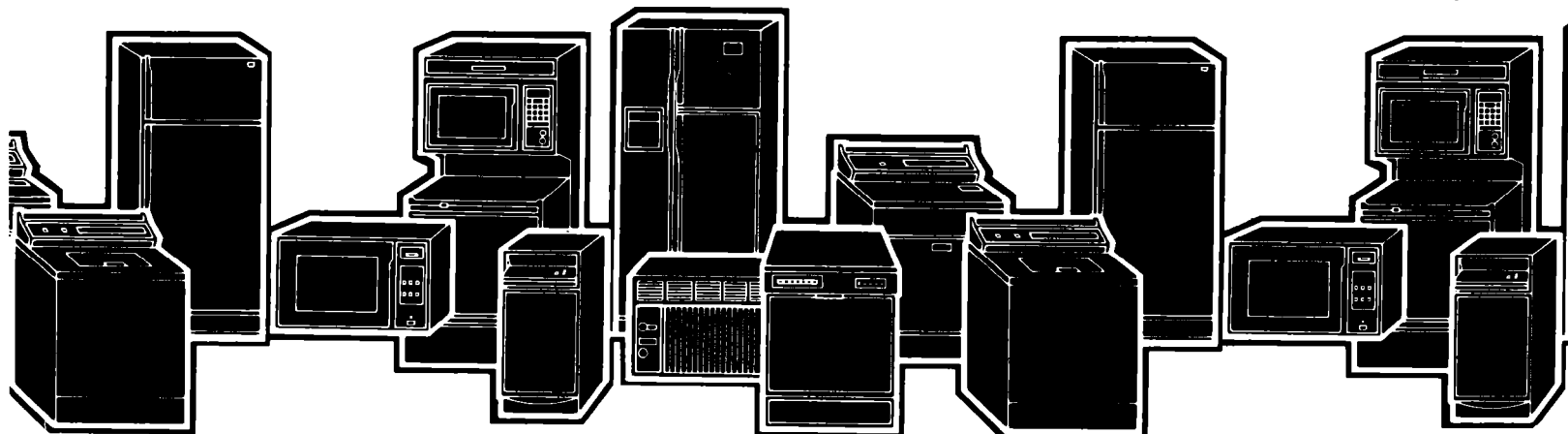

GAS RANGES

Refrigerator-Freezers, Ice Makers, Dishwashers, Built-In Ovens and Surface Units, Ranges, Microwave Ovens, Compactors, Room Air Conditioners, Dehumidifiers, Automatic Washers, Clothes Dryers, Freezers, I



Your responsibilities...

Proper installation and safe use of your appliance are your personal responsibilities. Read this "Use and Care Guide" carefully for important use and safety information.

Installation

You must be sure your appliance is...

- installed and leveled by a qualified installer or service technician;
- installed in a well-ventilated area protected from weather;
- properly connected to the correct electric supply and ground. (See page 20 of this booklet or the "Installation Instructions".)
- properly connected to the correct gas supply. (See "Installation Instructions".)

Proper Use

You must be sure your appliance is...

- used only for jobs expected of home ranges;
- used only by people who can operate it properly;
- properly maintained.

Contents

**FOR YOUR SAFETY...
IF YOU SMELL GAS:**

- 1. OPEN WINDOWS.**
- 2. DON'T TOUCH ELECTRICAL SWITCHES.**
- 3. EXTINGUISH ANY OPEN FLAME.**
- 4. IMMEDIATELY CALL YOUR GAS SUPPLIER.**

**FOR YOUR SAFETY
DO NOT STORE OR USE GASOLINE OR OTHER FLAMMABLE VAPORS AND LIQUIDS IN THE VICINITY OF THIS OR ANY OTHER APPLIANCE.**

Safety Precautions		Low Temp Oven Setting	10
Basic Range	1	Roasting Hints	11
Child Safety	1	Baking Hints	12-13
Surface Cooking	1	Broiling Hints	14
Oven Cooking	2	Care Information	15-17
Utensils	2	Special Features	
Constant Standing Pilots	2	Continuous Cleaning Oven	18
Solid State Ignition (Manual Lighting)	4	Eye Level Range	18
Tri-Temp® Burner Adjustment	4	Fan Noise Information	18
Basic Information on Surface Cooking		Programmed Oven Cooking	19
How Surface Burners Work	5	Delay Cook and Hold	19
Surface Burners with Solid State Ignition	5	Installation and Service Information	
Surface Burners with Pilots	5	Installation	20
Selecting Correct Flame Size	5-6	Nameplate	20
Care Information	6	Disconnecting Electrical Power	20
Special Features		Pressure Regulators	20
Griddle and Fifth Burner	8	If You Need Service or Assistance	
Clock, Minute Minder, Range Lights	8-9	1. Before Calling for Assistance	21
Basic Information on Oven Cooking/Broiling		2. If You Need Assistance	21
How Oven Works	10	3. If You Need Service	21
Preheating	10	4. If You Have a Problem	21

Copy Your Model and Serial Numbers Here

If you have a question, or need service, have this information ready:

- 1. Complete** Model and Serial Numbers from the nameplate. (See page 20 for location.)
- 2. Purchase or installation date** from your sales slip.

Copy this information in these spaces. Keep this book, your warranty, and the sales slip together in a handy place.

MODEL NUMBER
SERIAL NUMBER
PURCHASE/INSTALLATION DATE
SERVICE COMPANY AND PHONE NUMBER

IMPORTANT

INSTALLER: LEAVE THIS BOOKLET WITH THE APPLIANCE.

CONSUMER: KEEP THIS BOOKLET FOR FUTURE REFERENCE.

SAFETY PRECAUTIONS

Read all instructions before using this appliance

BASIC RANGE SAFETY

- Do not store combustible materials, gasoline or other flammable vapors and liquids near a range.
- If a range is installed near a window, proper precautions should be taken to prevent curtains from blowing over burners creating a FIRE HAZARD.

- The range should not be used as a space heater to heat or warm a room. This instruction is based on safety considerations, to prevent potential hazards and to prevent damage to range.

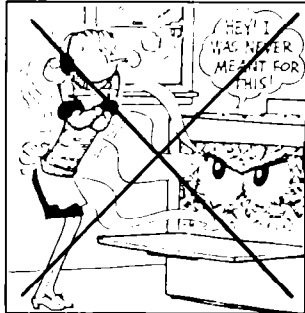

- The back of the range and the oven vent area become **TOO HOT TO TOUCH** when the oven is in use.

BE SURE ALL RANGE PARTS ARE COOL BEFORE TOUCHING OR CLEANING.

CAUTION: (For built-in wall oven only) Be careful, in opening oven door to avoid touching knuckles or fingers on hot oven vent trim, just above door handle; grasp door handle from underneath rather than from top.

- Keep range clean. If grease or spillovers are allowed to accumulate, they **MAY IGNITE**.

CHILD SAFETY

- Children **MUST BE TAUGHT** safe range practices to prevent possible injury. Listed below are some basic practices we recommend you read and follow for safe use of this gas appliance when children are present.

- **Do not leave children alone or unsupervised near the range when range is in use or is still hot.**

- Children should be taught that the range is not a toy. They should not be allowed to play with range controls or other parts of the range.

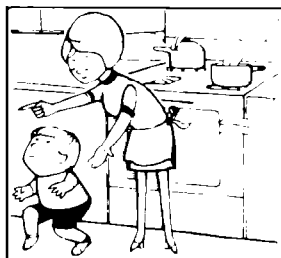

- Children **MUST** be taught that the range and utensils on the range can be hot.

CAUTION: Do not store items of interest to children in cabinets above a range, on the backguard, or back-splash of a range. Children climbing on the range to reach items could be seriously injured.

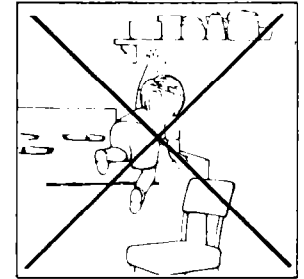

- The range should not be used as a step stool to cabinets above.
- Children should not be allowed to sit or stand on any part of the range.
- Let hot utensils cool in a safe place, out of reach of small children.

GAS ODORS

- A faint gas odor may indicate a pilot light is out. To re-light pilots, follow instructions on page 2. If a gas odor is detected when the pilot is burning, cut off the gas supply to the range. Call your installer or local gas company to have the possible leak checked. **NEVER USE A MATCH OR OTHER FLAME TO LOCATE A GAS LEAK.**

SURFACE COOKING SAFETY

- To eliminate the hazard of reaching over hot surface burners, cabinet storage space should not be provided over a range. **TEMPERATURES IN STORAGE AREAS ABOVE THE RANGE MAY BE UNSAFE FOR STORAGE OF SOME TYPES OF MATERIALS SUCH AS VOLATILE LIQUIDS OR AEROSOL SPRAYS.**

- A cooking utensil should be in place whenever a surface burner is turned on. The utensil will absorb heat and prevent possible damage to the grate and surface burner. The utensil will also serve as a shield from the burner in case any combustible materials are nearby.

- **AVOID REACHING OVER A BURNER FLAME WHILE WEARING LOOSE FITTING CLOTHING.** Clothes may ignite or may catch utensil handles.

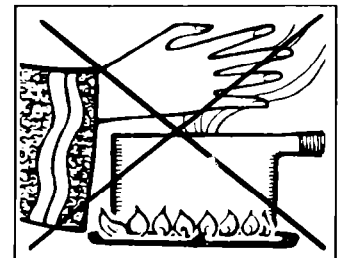

SAFETY PRECAUTIONS

If you must reach over a surface burner, turn burner off. Use DRY sturdy pot holders. DAMP POT HOLDERS MAY CAUSE BURNS FROM STEAM. Dish towels or other substitutes are not recommended for they may trail across hot surface burners and ignite or get caught on range parts.

GREASE

HOT GREASE IS FLAMMABLE. Avoid letting grease deposits collect around range, range hood or in vent fan. Do not leave can of drippings around range. Let quantities of hot fat, used for deep fat frying, cool before attempting to move or handle.

In the event of a grease fire, do not attempt to move pan. Turn surface burner off and cover pan to extinguish flame. DO NOT DOUSE FLAME WITH WATER. Use a dry chemical type fire extinguisher, if available, or sprinkle heavily with baking soda.

OVEN COOKING SAFETY PRECAUTIONS AND HINTS

Never reach directly into a hot oven to add or remove cooking utensils. Rather, use DRY sturdy pot holders and pull oven rack out before adding or removing utensils. Do not use DAMP pot holders because they will cause steam burns. Dish towels or other substitutes are not recommended as they may get caught on range parts or ignite.

Do not use the oven as a storage area.

DO NOT HEAT AN UNOPENED GLASS OR METAL CONTAINER IN THE OVEN. Pressure buildup in the container may cause it to burst and result in serious personal harm or damage to the range.

OVEN AIR FLOW AND OVEN BURNER FLAME APPEARANCE

Unrestricted air flow through the oven is necessary for safe and proper operation of the oven burner. Do not obstruct air intake located below broiler drawer.

The flame size and appearance of a properly adjusted oven burner should look like this illustration.

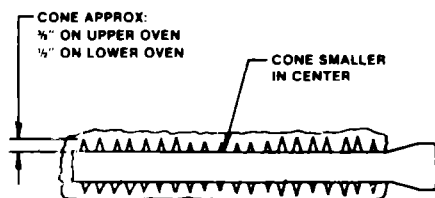

BROILER PAN

Always remove soiled broiler pan from the broiler compartment after cooking for GREASE LEFT IN THE PAN MAY BECOME HOT ENOUGH TO IGNITE. Using the broiler compartment for storage is not recommended. The broiler pan should be in place when oven is in use.

EYE LEVEL OVEN

Do not use the Eye Level oven for cooking items that are too heavy or bulky to handle easily, especially if considerable amounts of hot fat are involved. Removing this type of food from the upper oven may be hazardous.

The upper Eye Level oven will either be a conventional baking oven or a microwave oven. Please refer to the Use and Care Of Your New Microwave Oven Booklet for instructions on the microwave oven.

GENERAL SAFETY PRECAUTIONS AND HINTS FOR COOKING UTENSILS

Choose pans that are easily grasped with handles that stay cool. Avoid using pans that are unstable, warped, or easily tipped. If pan handles twist and cannot be tightened, discard them. Pans that are too heavy to move easily when filled with food may also be a hazard.

Be sure utensil is large enough to properly contain food and avoid boilovers. Pan size is especially important in deep fat frying. Be certain pan is large enough to accommodate volume of food that is to be added and for the bubble action of fat. NEVER LEAVE A DEEP FAT FRYING OPERATION UNATTENDED.

Always turn pan handles to the side or back of the range, not out into the room where they are easily hit or reached by small children.

Never leave a pan unattended when using a high flame setting. Only use a high setting to bring liquids to a boil or begin cooking, then REDUCE to a lower flame setting to continue the cooking operation. Never use a high flame setting for extended cooking. REMEMBER: Food will not cook any faster when more than the amount of heat needed to maintain a gentle boil is used.

PLASTICS

Many plastics are vulnerable to heat. Keep plastics away from parts of the range that may become warm or hot. Follow manufacturer's directions for oven cooking bags or browning bags.

ALUMINUM FOIL

Use aluminum foil ONLY as instructed on page 12 in this booklet. Improper use may cause damage to the range and may affect cooking results.

AEROSOL SPRAYS

Many aerosol-type spray cans are EXPLOSIVE when exposed to heat and may be highly flammable. Avoid their use or storage near a hot range. Do not use aerosol products other than spray-type oven cleaners in or near a gas range. If used frequently over a period of time, ingredients in some aerosols may cause metal parts of the range to rust and corrode.

HOW TO LIGHT CONSTANT STANDING PILOTS

(This information is NOT for ranges equipped with Solid State Ignition.)

Be sure Oven Temperature Control and Surface Burner Controls are OFF before lighting pilots.

Surface Burners and Griddle Pilots: Raise and support cooktop on the metal rod. Hold a lighted match near the pilot ports.

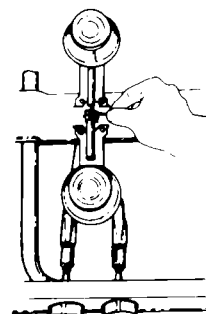

Lower Oven Pilot: Remove oven racks and oven bottom. Hold a lighted match to the pilot located at the far end of the oven burner. When pilot is lighted, replace oven bottom and oven racks. Be sure to secure the two screws located at the front of the oven bottom.

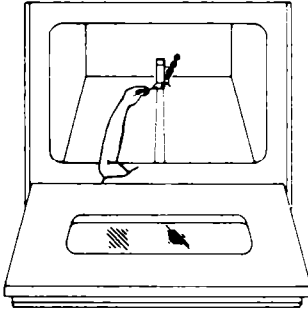

Eye Level Oven Pilot: Remove oven racks and oven bottom. Hold a lighted match to the pilot located along the left end of the burner. The pilot flame is partially hidden by a metal shield so it may be difficult to actually see the flame.

Replace oven bottom and oven racks. To check oven ignition, turn Oven Temperature Control to a low setting. After a 45 to 60 second delay, the oven burner will ignite if the pilot is lighted.

HOW TO ADJUST CONSTANT STANDING PILOTS FOR SURFACE BURNERS ONLY

(This information is NOT for ranges equipped with Solid State Ignition.)

1. Remove cooktop and Oven Temperature Control knob. Locate top burner and pilot adjusting screw.

(a) Adjusting screw is to the LEFT of the oven control on the MANIFOLD PIPE for all freestanding ranges without the Programmed Oven Cooking feature or the Griddle/Fifth Burner feature and in the CENTER of the MANIFOLD PIPE for the Built-In Surface Unit.

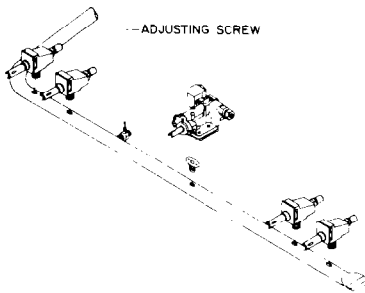

(b) Adjusting screw is on the UPPER RIGHT SIDE of the oven control for all freestanding ranges with the Programmed Oven Cooking feature but without the Griddle/Fifth Burner feature.

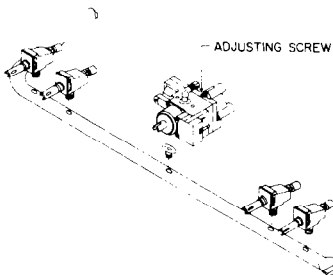

(c) There are two (2) adjusting screws on 36-inch ranges equipped with the Griddle/Fifth Burner feature. One screw adjusts the surface burner pilots and the other adjusts the Griddle/Fifth Burner pilot.

(1) If range is NOT equipped with the Programmed Oven feature, the two screws are located to the LEFT of the oven control on either side of the griddle valve on the MANIFOLD PIPE.

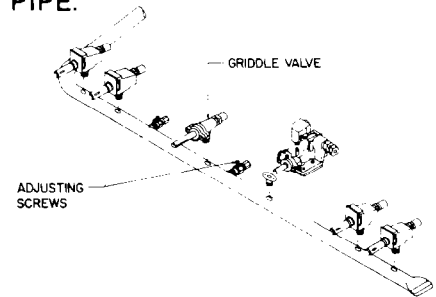

(2) If a range is equipped with the Programmed Oven feature, the griddle pilot adjusting screw (A) is located to the LEFT of the griddle valve on the MANIFOLD PIPE and the surface burner pilot adjusting screw (B) is located on the UPPER RIGHT SIDE of the oven control.

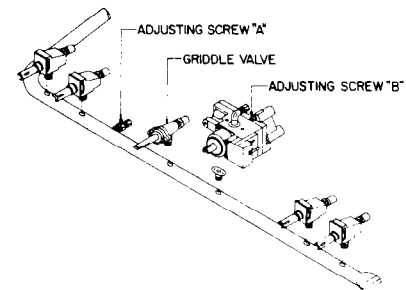

2. Insert a small screwdriver into the adjusting screw and turn the screw to the right or left until the flame on the pilot is 1/4-inch in height.

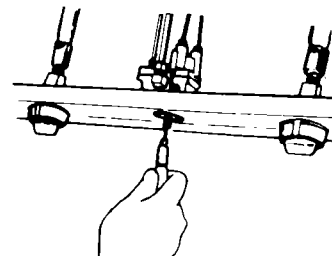

CAUTION: DO NOT TURN THE SCREW LOCATED IN THE CENTER OF THE OVEN CONTROL STEM.

3. Replace cooktop and Oven Temperature Control knob.

HOW TO OPERATE APPLIANCE EQUIPPED WITH SOLID STATE IGNITION IN THE EVENT OF A PROLONGED POWER FAILURE

If a power failure should occur, manually light the surface burners by holding a lighted match near the surface burner and turn the surface burner on.

Due to safety considerations, manual lighting of the upper Eye Level oven is NOT recommended.

To manually light oven pilot: CAUTION—OVEN MUST BE COOL WHEN MANUALLY LIGHTING OVEN PILOT. If oven is warm, wait until oven cools before lighting pilot.

1. Open broiler compartment drawer to the stop position. Place broiler tray and pan in lowest rack position.
2. Oven pilot is located on the right side of the oven burner at the back of the oven.
3. Hold a lighted match and reach through the broiler compartment to the oven pilot.

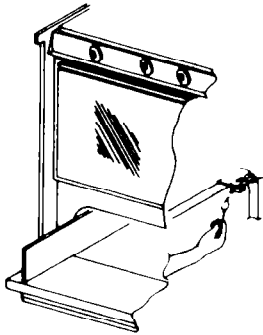

4. While holding the match near the tip of the pilot, turn the Oven Temperature Control to the desired temperature. Immediately remove hand from broiler compartment. Burner will light after a 20 to 60 second delay.

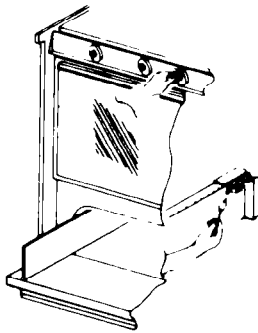

5. Close broiler drawer.

When cooking is finished, turn the Oven Temperature Control to OFF. This will shut off all gas to the oven. Whenever electrical power is off, you will have to light the pilot manually **each time** you wish to use the oven.

CAUTION: IF THE OVEN BURNER DOES NOT LIGHT WITHIN 20 TO 60 SECONDS AFTER THE PILOT IS LIGHTED, TURN THE OVEN TEMPERATURE CONTROL TO OFF AND WAIT FOR POWER TO BE RESTORED. DO NOT ATTEMPT TO RELIGHT THE PILOT AGAIN. If oven does not function properly when the power is restored, call a serviceman to determine the problem.

TRI-TEMP® BURNER ADJUSTMENT

The Tri-Temp® burner valve has "click" sounds to identify the HIGH, MEDIUM and WARM settings.

To adjust the flame size:

1. Push in and turn surface burner knob to HIGH. For ranges equipped with Solid State Ignition, turn knob past HIGH to (START) or the light position.

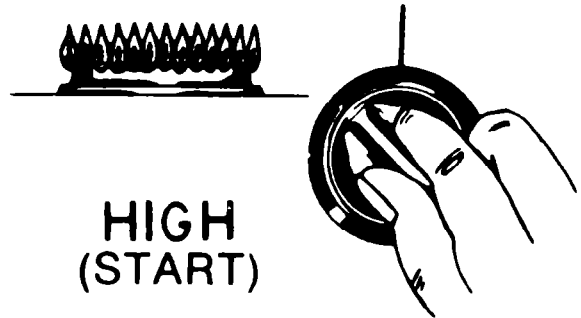

2. When burner lights, turn knob to WARM.



3. Remove knob being careful not to change the position of the stem. Grasp stem firmly and insert small blade screwdriver into the center of the gas valve stem.

Turn the screwdriver in either direction until the flame height is 1/8-inch or lower in size.

Flame must be of sufficient size to maintain a **STABLE FLAME** on all burner ports.

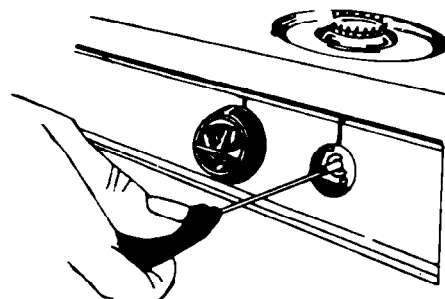

NEVER ADJUST THE FLAME SIZE AT THE MEDIUM SETTING.

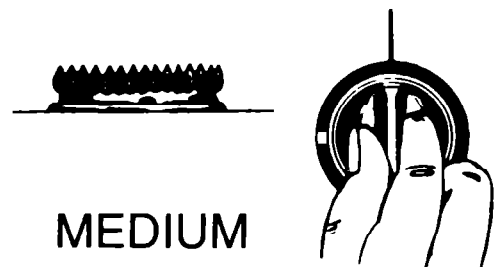

SURFACE COOKING INFORMATION

HOW A SURFACE BURNER WORKS

When the surface burner valve (A) is turned on, gas enters the mixer tube or venturi (B) and comes in contact with air. This air/gas mixture flows to the burner head (C) and is lighted by either the flame from the pilot or a spark from the solid state ignitor (D).

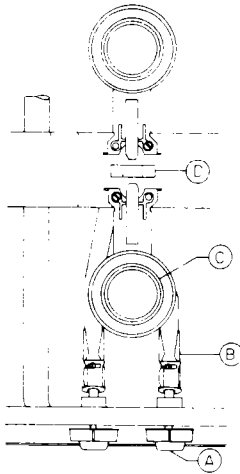

A properly adjusted burner with clean ports will light within a few seconds. The cone-shaped flame will be clear blue in color with a clearly defined inner cone. There should be no trace of yellow in the flame. A yellow flame indicates an improper mixture of air and gas. This wastes fuel so have a serviceman adjust the air/gas mixture if a yellow flame ever occurs.

HOW TO OPERATE SURFACE BURNERS WITH SOLID STATE IGNITION

Solid State Ignition eliminates the pilots. Ranges or built-in surface units equipped with solid state ignition operate the same as conventional ranges.

To operate this type burner:

1. Push in and turn control to the left **past** HIGH to the (START) position. This is the light position. The clicking sound indicates that the ignitor is producing sparks to light the surface burner. Sometimes you may notice some static interference with your radio, television or stereo system when the ignitor is producing sparks.
2. When the burner lights, turn the control back to the desired setting. If selecting a high flame setting, adjust the knob until there is no clicking sound. The clicking sound will stop and the ignitor will turn off. Do not leave the control in the (START) position once the burner lights.
3. If the flame should go out during a cooking operation, turn the burner off. **IF GAS HAS ACCUMULATED AND A STRONG GAS ODOR IS DETECTED, WAIT 5 MINUTES FOR THE GAS ODOR TO DISAPPEAR BEFORE RELIGHTING BURNER.**

See page 4 for instructions on manually lighting the surface burners in the event of a power failure.

HOW TO OPERATE SURFACE BURNERS WITH PILOTS

Your range or built-in surface unit is equipped with one of two types of surface burner valves. They can be identified by the markings on the control. One type of burner has HIGH (START) and OFF printed on the control. This is called an EFFLEX® burner. The other type of burner has HIGH (START), MEDIUM and WARM printed on the control with "click" sounds to identify these 3 settings. This is called a Tri-Temp® burner.

To operate either type of burner: Push in and turn control to the left to HIGH (START). When the burner lights, turn control back to the desired flame size.

If the flame should go out during a cooking operation, turn the burner off. **IF GAS HAS ACCUMULATED AND A STRONG GAS ODOR IS DETECTED, WAIT 5 MINUTES FOR THE GAS ODOR TO DISAPPEAR BEFORE RELIGHTING BURNER.** To relight burner, push in and turn knob to HIGH.

SELECTING CORRECT FLAME SIZE

Use the HIGH flame setting to quickly bring foods to a boil or to begin a cooking operation. Then reduce to a lower setting to continue cooking. Never leave food unattended over a high flame setting.

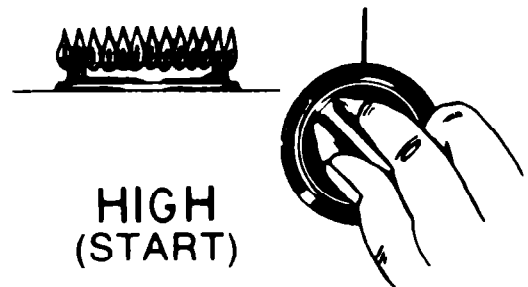

MEDIUM is used to continue a cooking operation. Food will not cook any faster when a higher flame setting is used than that needed to maintain a gentle boil. Remember, water boils at the same temperature whether boiling gently or vigorously.

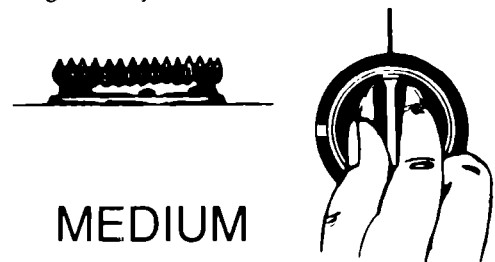

Use WARM to keep food at serving temperatures without further cooking. You may find that some cooking may take place if the cooking utensil is covered.

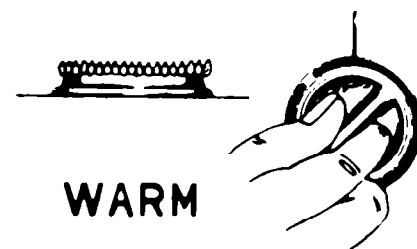

FACTORS TO CONSIDER WHEN SELECTING CORRECT FLAME SIZE

SIZE OF COOKING UTENSIL: FLAME SIZE SHOULD BE ADJUSTED SO IT DOES NOT EXTEND BEYOND THE EDGE OF THE COOKING UTENSIL FOR YOUR PERSONAL SAFETY AND TO PREVENT POSSIBLE DAMAGE TO CABINETS ABOVE RANGE.

Adjusting the size of the flame to fit the size of the cooking utensil also helps to save fuel.

UTENSIL MATERIALS: Stainless steel, porcelain, enamelware, glass, glass ceramic and Teflon®-coated utensils designed for surface cooking usually heat slowly and conduct heat poorly when a large flame size is used. Adjust the flame size to extend only halfway between center and edge of the utensil bottom for better cooking results.

Aluminum utensils conduct heat more evenly; therefore, a slightly larger flame size can be used. The flame can be adjusted so it comes to the edge of the utensil. The

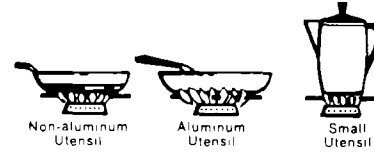

flame should NEVER be adjusted so that it extends beyond the bottom of the utensil.

COVERED UTENSILS: If the utensil is covered less fuel will be needed; therefore, a lower flame size can be used.

REMEMBER: Food will not cook any faster when more than the amount of heat needed to maintain a gentle boil is used. See page 2 for additional information on the safe use of utensils.

CARE INFORMATION

Be sure the range or built-in surface unit is cool before removing any parts or cleaning the unit. Any parts removed in the cleaning should be replaced correctly.

COOKTOP AND GRATES

To remove cooktop: First remove grates and reflector pans. Then grasp front two burner wells and lift up. Top can be completely removed or can rest on the metal rod located across the center of the burner box. (Built-in units do not have a metal support rod nor can they be completely removed.)

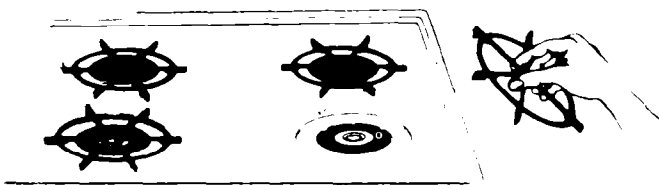

To clean burner box: 1) Remove cooktop or support cooktop on metal rod. 2) The burner box, located under the cooktop should be cleaned frequently with soap and water to remove spillovers. If soil is not removed and is allowed to accumulate, it may damage the finish. 3) If desired, an application of appliance wax can be used to protect the finish of the burner box.

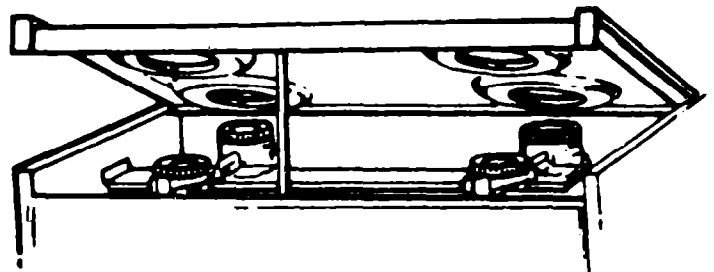

To replace cooktop if completely removed: Insert two tabs on the back of the cooktop into the slots on the back of the range. Lower into place applying pressure at the front edges to secure top to the range.

To clean porcelain-enamel cooktop: 1) When surface is cool, clean with warm soapy water. TO PREVENT POSSIBLE CRACKING AND CHIPPING, NEVER WIPE OFF A WARM OR HOT ENAMEL SURFACE WITH A DAMP CLOTH. 2) Porcelain-enamel is a glass fused on metal and will crack or chip with misuse. All spillovers, especially acid spillovers, should be wiped up immediately with a **dry** cloth. 3) Do not use abrasive or caustic cleaning agents on exterior finish of range.

To clean grates: Grates are made of porcelain-coated steel and can be cleaned with warm soapy water or in the dishwasher. Use a soap-filled scouring pad for stubborn soil.

To clean control knobs: 1) Remove knobs by gently pulling off. 2) Clean with warm soapy water. 2) Do not use abrasive cleaning agents for they will scratch the finish and remove markings. 4) Replace knobs.

SURFACE BURNERS

Shipping screws are used to secure each surface burner to the range during transportation. **Once range is installed, the screws should be removed.**

To remove burner: 1) Remove or support cooktop with metal rod. 2) Grasp burner head and tilt to release tab from slot near pilot. 3) Lift burner up and toward rear of range until burner is released.

To replace burner: 1) Insert the air shutter end of the burner over the hood and lower burner into place. 2) Insert tab on burner into slot in burner support located in burner box. If burner is not replaced correctly, cooking results will be affected, burner will not operate properly and a safety hazard could occur. 3) Replace cooktop.

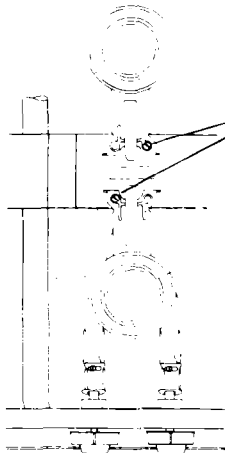

A natural dulling of the surface burner's aluminum finish should be expected. This is a permanent dulling and will occur over a period of time and with continued usage. Cleaning practices may improve the appearance but will not completely restore the finish to its original luster.

DISCOLORATION WILL ALSO OCCUR TO THE SURFACE BURNER WHEN:

1. The burner is turned on without a pan in place to absorb heat. This is especially critical when the flame is adjusted to the MEDIUM flame setting.
2. Incorrect cleaning agents are used. Some cleaning agents can scratch or dull the aluminum finish of the burner head.
3. Cleaned in the dishwasher. Dishwasher detergents are harsh and caustic and will permanently dull the aluminum finish.
4. Boilovers occur when the flame is adjusted to a HIGH flame setting.
5. Cleaning is infrequent or soil is allowed to burn on before cleaning.

To clean surface burners: Clean burners in warm soapy water after each use or as they become soiled. Remove stubborn soil by scouring with a nonabrasive plastic scouring pad such as Tuffy® and a paste of baking soda and water.

Clean ports with a straight pin. Do not use a wooden toothpick or other objects that might enlarge or break off and clog a port. Both burner ignition and cooking results will be affected if a port is enlarged or clogged.

The following cleaning agents **ARE NOT RECOMMENDED FOR CLEANING SURFACE BURNERS** for they will permanently damage the finish: Caustic cleaners such as oven cleaners, steel wool, abrasive cleaning or scouring agents, dishwasher detergent or metal polishes.

After cleaning, burners can be dried in the oven set at 140°F. (60°C.). **CAUTION: BURNERS AND BURNER TUBES MUST BE DRY BEFORE USE.**

MAINTENANCE AND SERVICE

1. Always keep appliance area clear and free from combustible materials, gasoline and other flammable vapors and liquids.
2. Do not obstruct or restrict the flow of combustion and ventilation air.
3. The visual check and adjustment of pilot flames made per the printed installation instruction sheets should be repeated whenever service has been interrupted or upon relighting pilots. Normally the pilot flame and surface and oven burner flames should not require adjustment beyond those made at installation. It is good preventive maintenance, however, to occasionally check pilot's flame size and burner flame patterns. Should you detect significant variation, service may be needed. (See inside back cover for specific checks you can make.)
4. Cleaning procedures for various appliance parts are given along with the description and use instructions for those parts in this book (see particularly pages 6, 7 above, 8, 15, 16, the general cleaning chart on page 17, and page 18.) The frequency of cleaning will vary depending on use.
5. Lubrication of moving parts should not normally be required with the one exception of the oven door hinges which may occasionally require a tiny drop of household oil at the pivot point. Lubricate these points sparingly only when and if the normal sounds of opening or closing of door changes significantly.
6. Replacement parts may be obtained through your local dealer (see inside back cover.)

SPECIAL FEATURES

GRIDDLE AND FIFTH BURNER

(36-inch models only)

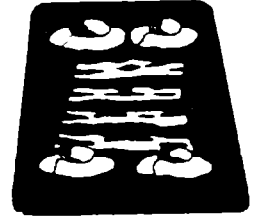

HOW TO USE THE GRIDDLE

Before griddle is used the first time, season it by lightly rubbing surface with a small amount of unsalted shortening. Do not use butter, margarine or oil for they will discolor finish. Do not use sharp metal instruments, over-heat or suddenly change temperatures for these will damage finish.

1. Remove porcelain griddle cover.
2. Be sure grease cup, located under griddle, is in place.
3. Position Teflon®-coated griddle correctly. A mirror is provided just under the thumb hole on the griddle. Use the mirror to view flame for flame size adjustment.
4. For even cooking results, preheat griddle using a medium flame size for about 5 minutes or until the entire cooking surface is evenly heated.

Sprinkle a few drops of water over the surface; if properly heated, the water will bead and "dance." The water will sizzle and steam if griddle is not hot enough.

5. CAUTION: Remove griddle cover before igniting burner when using the griddle or fifth burner.

NEVER REPLACE GRIDDLE COVER UNTIL GRIDDLE HAS COMPLETELY COOLED.

TO CLEAN THE GRIDDLE

Allow griddle to cool. Wash in hot soapy water, rinse and dry. Do not use abrasives or scouring powders for they will scratch the finish. Do not clean the Teflon®-coated griddle in the dishwasher. Detergents used for dishwashers are too strong and will remove the seasoning.

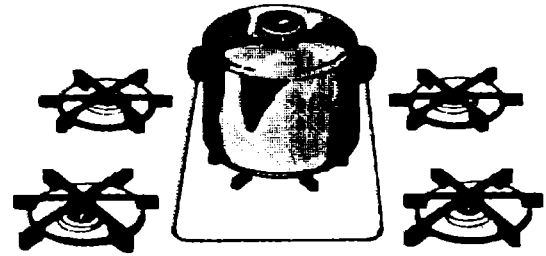

TO USE THE FIFTH BURNER

To convert griddle into the Fifth Burner, remove the cover and griddle and replace with the porcelain insert and grate.

Follow the same instructions for using surface burners on page 5.

CLOCK, MINUTE MINDER AND RANGE LIGHTS

CLOCK

To set dial-type clock, **push in** and turn Minute Minder knob to the left to the correct time-of-day. Be sure Minute Minder hand is on OFF after setting clock.

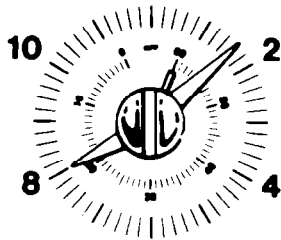

To set digital-type clock, **push in** and turn Minute Minder knob in either direction to the correct time-of-day. Be sure Minute Minder hand is on OFF after setting clock.

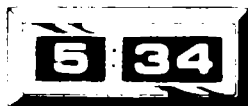

MINUTE MINDER

To set Minute Minder, turn knob in either direction to the desired time. When the bell rings, manually turn the Minder to OFF.



RANGE LIGHTS

Surface Lights: Your range or built-in unit may be equipped with one of the following two types of light switches: either a push in switch marked TOP which you **hold** until the light comes on or a flip switch marked SURFACE LIGHT

Oven Lights: Your range or built-in oven may be equipped with one of the following two types of oven light switches: either a push in switch marked OVEN, or a flip switch marked OVEN LIGHT.

To Replace Oven Light: NEVER REPLACE BULB UNTIL BOTH THE OVEN AND BULB ARE COOL.

1. DISCONNECT POWER TO RANGE. (Raise cooktop and disconnect plug located under cooktop behind right rear surface burner.)

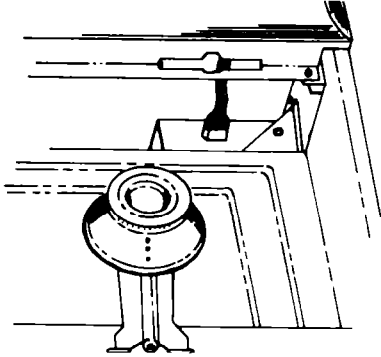

2. Remove bulb with a dry pot holder to prevent possible harm to hands. If bulb should break, use a pot holder to protect hands and **very carefully** remove bulb. If bulb breaks at base, have a serviceman remove bulb.
3. Replace with a 40-watt APPLIANCE bulb. Reconnect power to range and replace cooktop.

REPLACING RANGE LIGHTS

Be sure range parts and bulb are cool. DISCONNECT POWER TO RANGE (see above or page 20) before replacing any light bulb or fluorescent tube.

SURFACE LIGHTS

Grasp top trim at each end with thumbs under edge. Lift trim up and back. Replace fluorescent tube taking care not to touch the metal at the ends of the tube. Snap top trim back into place. Reconnect power to range.

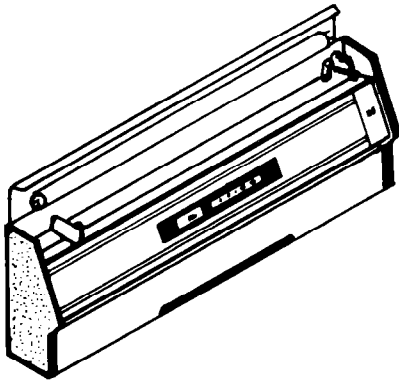

EYE LEVEL RANGE WITH LIGHTED BACKSPLASH

Remove three screws in chrome strip at top of backsplash glass. When removing chrome strip, use care so glass does not fall out. Remove glass by tilting forward. Replace fluorescent tube taking care not to touch the metal at the ends of the tube. Reverse procedure to replace glass. Reconnect power to range.

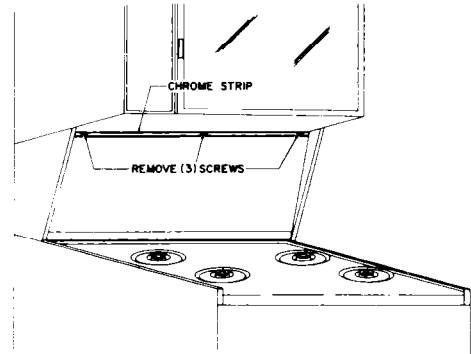

EYE LEVEL RANGE WITH PORCELAIN BACKSPLASH

Fluorescent tube is behind a metal trim strip located across the top of the backsplash. Replace fluorescent tube taking care not to touch the metal at the ends of the tube. Reconnect power to range.

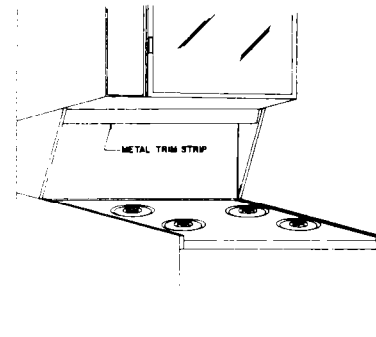

BUILT-IN OVEN

Remove two phillips screws located near top of each side trim strip. Lift top trim strip up and remove. Remove all knobs. Remove metal rings around light switches by unscrewing counter clockwise. Remove washers. Tilt top of glass slightly forward, lift straight up and off control panel. Replace fluorescent tube taking care not to touch the metal at the ends of the tube. Reverse procedure to reinstall panel. Reconnect power to range.

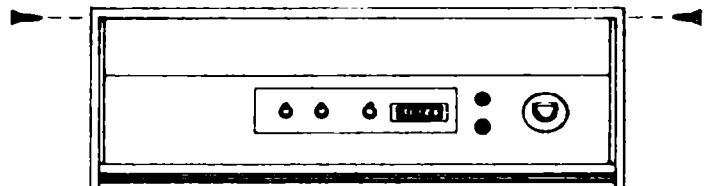

BASIC INFORMATION ON OVEN COOKING AND BROILING

HOW THE OVEN WORKS

When the Oven Temperature Control is turned to a desired setting, there will be a 45 to 60 second delay before the oven burner lights. This delay is for safety considerations. When the oven reaches the temperature set on the Oven Temperature Control, the oven burner will automatically cycle on and off to maintain the preset temperature. If the Oven Temperature Control is turned to BROIL, the oven burner will remain on for most normal broiling operations. The burner will cycle on and off for extended broiling operations.

HOW OVEN EQUIPPED WITH SOLID STATE IGNITION WORKS

Ovens equipped with Solid state Ignition operate the same as a conventional gas oven. When the Oven Temperature Control is turned to a desired setting, you can hear clicking sounds for the first 5 to 10 seconds until the ignitor lights the oven pilot. The pilot, in turn, lights the oven burner. When the Oven Temperature Control is turned off, both the oven pilot and burner go out. On some models, you can hear a click sound from the ignitor when the Oven Temperature Control is turned off. Occasionally, you may notice some static interference with your radio, television or stereo system when the ignitor is producing sparks.

See page 4 for instructions on manually lighting the oven in the event of a prolonged power failure.

OVEN CHARACTERISTICS

Every oven has its own personal characteristics. You may find that the cooking times and temperatures you were accustomed to with your old range may alter slightly with your new range. Please expect some differences with this new range.

PREHEATING

Preheating is necessary only for baking operations; it is not necessary to preheat the oven for broiling or roasting. To preheat, turn the Oven Temperature Control to the desired temperature setting. Do not select a higher setting, for the oven will not preheat any faster. Allow about 10 minutes for the oven to heat before placing food in the oven.

LOW TEMP OVEN SETTING

The Low Temp Setting (140 to 200°F.) can be used to keep foods at serving temperatures without further cooking, for thawing frozen foods, refreshing baked goods or for warming plates or serving dishes. Be sure utensils are ovenproof. Do not warm silver, silverplate or plastics in the oven. Food is more palatable and nutritious if kept warm no longer than 1½ to 2 hours.

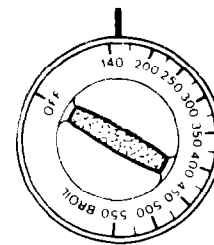

If the oven was not in use and is cool, preheat to a Low Temp setting for about 5 to 8 minutes.

If the oven has been set at a higher temperature or is still warm: Either reduce to a Low Temp setting 15 minutes before the end of cooking and let the oven cool with the door closed, or reduce oven temperature after cooking and leave the door opened for five minutes. Use caution if small children are around the hot oven door when it is open.

OVEN TEMPERATURE CONVERSION CHART

DESCRIPTION	DEGREES FAHRENHEIT (°F)	DEGREES CENTRIGRADE (°C)
Keep warm (Lo-Temp) oven	140-170	60.0-76.7
Warm oven	200-225	93.3-107.2
Very slow oven	250-275	121.1-135.0
Slow oven	300-325	148.9-162.8
Moderate oven	350-375	176.7-190.6
Hot oven	400-425	204.4-218.3
Very hot oven	450-475	232.2-246.1
Extremely hot oven	500-525	260.6-273.9
Maximum temperature	550-575	287.8-301.7

HINTS FOR SUCCESSFUL ROASTING

Roasting is the cooking of tender cuts of meat with dry heat. No water is added nor is the cooking utensil covered. Searing is unnecessary. If desired, season meat with salt and pepper.

Check weight of meat and place fat-side-up on a rack in a shallow roasting pan.

Arrange oven rack in one of the two bottom rack positions before oven is turned on. Preheating is unnecessary for roasting meats.

Meats are roasted at 325°F. except tenderloin (425°F.) and smaller poultry (375 to 400°F.). Turn the Oven Temperature Control to the desired temperature.

Cooking time is determined by the weight of the meat and the desired doneness. Use the chart given below as a guide in determining cooking times. The most accurate way is with a meat thermometer. Insert thermometer so the tip is in the center of the thickest part of the meat and is not touching bone or fat.

After cooking, remove meat from oven and let stand 15 to 20 minutes for easier carving. Rare or medium rare meats should be removed from the oven when the internal temperature is 5 to 10° less than the final desired temperature for meat will continue to cook slightly while standing.

Frozen meat may be cooked in the same way as fresh meat if the meat is thawed first. It is also possible, however, to cook meat from the frozen state. Follow the same roasting instructions but increase cooking time approximately 10 to 25 minutes per pound. When using frozen packaged meat, follow package directions. Frozen poultry should always be thawed before cooking except when package directions recommend cooking from the frozen state such as for frozen turkey rolls. **DO NOT REFREEZE MEATS THAT HAVE NOT BEEN COOKED FIRST.**

ROASTING GUIDE

CUT OF MEAT	APPROXIMATE WEIGHT	INTERNAL TEMP.	COOKING	
			TEMP.	TIME
BEEF Standing Rib	6 to 8-lbs.	140° F. (rare) 160° F. (medium) 170° F. (well done)	300-325° F.	23 to 25 min/lb. 27 to 30 min/lb. 32 to 35 min/lb.
	4 to 6-lbs.	140° F. (rare) 160° F. (medium) 170° F. (well done)	300-325° F.	26 to 32 min/lb. 34 to 38 min/lb. 40 to 42 min/lb.
Rolled Rib	5 to 7-lbs.	140° F. (rare) 160° F. (medium) 170° F. (well done)	300-325° F.	32 min/lb. 38 min/lb. 48 min/lb.
Rib Eye	4 to 6-lbs.	140° F. (rare) 160° F. (medium) 170° F. (well done)	350° F.	18 to 20 min/lb. 20 to 22 min/lb. 22 to 24 min/lb.
Tenderloin, Whole	4 to 6-lbs.	140° F. (rare)	425° F.	45 to 60 minutes (total time)
	2 to 3-lbs.	140° F. (rare)	425° F.	45 to 50 minutes (total time)
Sirloin Tip (High quality)	3 to 4-lbs.	140 - 170° F.	325-350° F.	35 to 40 min/lb.
	6 to 8-lbs.	140 - 170° F.		30 to 35 min/lb.
Rolled Rump (High quality)	4 to 6-lbs.	150 - 170° F.	325-350° F.	25 to 30 min/lb.
PORK LOIN Center Half	3 to 5-lbs	170° F.	325° F.	30 to 35 min/lb.
	5 to 7-lbs	170° F.	325° F.	35 to 40 min/lb.
LAMB. LEG	5 to 9-lbs	140° F. 160° F. 170 - 180° F.	325° F.	20 to 25 min/lb. 25 to 30 min/lb. 30 to 35 min/lb.

HINTS FOR SUCCESSFUL BAKING

OVEN RACKS: Arrange oven racks in the correct positions BEFORE the oven is turned on. If using only one rack, position rack so the food is near the center of the oven. If using both racks, allow 3 to 4 inches between racks. The racks should be arranged so they divide the oven in thirds.

PAN PLACEMENT: Allow 2 inches between utensils and the oven walls. Utensils should not touch each other, the oven walls or the oven window, on models so equipped. When using both racks for cooking, stagger the utensils so one is neither directly over another nor touching each other or the oven walls.

Cooking results will be affected by the use of utensils that are too large for the oven rack, misplacement of utensils in the oven or placing too many utensils on an oven rack. Incorrect placement of cooking utensils in the oven will prevent proper oven air circulation which affects cooking results and oven operation.

Never place pans directly on the oven bottom.

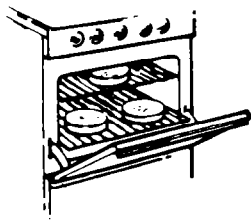

TIMINGS: Check the food after the minimum time recommended in the recipe and continue checking at intervals until the food is done.

Leave the oven door closed until the minimum baking time given has elapsed, then check food. Do not be a "peeping Tom". Opening the door frequently during cooking allows excessive heat to escape which wastes fuel and affects baking results.

UTENSILS: To obtain good baking results, use bright or light colored aluminum pans for cookies or biscuits and dull or anodized aluminum pans for pies and breads. Dark pans absorb heat and cause overbrowning.

Bake biscuits and cookies on a flat sheet or very shallow pan. The bottom of an inverted pan may be used. If sheet or utensil has sides, pale or light browning will occur.

For a crisp crust, use glass or dull, anodized aluminum pie plates and bread pans.

When baking cakes in glass utensils, lower recommended temperature by 25° F. and use the recommended cooking time in the recipe. It is not necessary to lower temperatures for baking pies or cooking casseroles in glass utensils.

Use level pans. Warped ones result in uneven browning and poorly shaped products.

Use the size pan recommended in the recipe. As a general guide, cake pans should be filled only about two-thirds full.

CORRECT USE OF ALUMINUM FOIL: Do not place aluminum foil directly on the oven bottom. A piece of foil that is slightly larger than the cooking utensil can be placed on the rack directly below the one holding the cooking utensil.

Do not completely cover an oven rack with foil. This blocks air flow, affects cooking results and could be a safety hazard.

Do not use aluminum foil directly under a cooking utensil. Foil will reflect heat away from the utensil and will cause pie crusts to be soggy on the bottom crust or have pale browning on the top crust.

COMMON BAKING PROBLEMS AND WHY THEY HAPPEN

<p>FOOD NOT DONE AT END OF COOKING TIME.</p> <ul style="list-style-type: none"> —Temperature too low. —incorrect use of aluminum foil. —Too many pans on a rack. —Oven door opened frequently. 	<p>PIE BURNS AROUND EDGE OF CRUST.</p> <ul style="list-style-type: none"> —Temperature too high. —Pans touching each other or the oven walls. —Edge of pie crust too tall.
<p>CAKE NOT DONE IN CENTER.</p> <ul style="list-style-type: none"> —Temperature too high. —Pan too small. —Pan not in center of oven. 	<p>PIE HAS SOAKED CRUST.</p> <ul style="list-style-type: none"> —Temperature too low at start of baking. —Filling too juicy. —Used shiny pans not dark or anodized pan.
<p>CAKE UNDERSIZED.</p> <ul style="list-style-type: none"> —Too little leavening. —Batter overbeaten. —Pan too large. —Temperature too high. 	<p>BROWNING PATTERN IS UNEVEN.</p> <ul style="list-style-type: none"> —Utensils too large. —Utensils are of different materials. —Oven racks too close to oven bottom. —Incorrect use of aluminum foil. —Oven vent may be blocked.
<p>CAKE FALLS</p> <ul style="list-style-type: none"> —Too much shortening, liquid or sugar. —Too much leavening. —Temperature too low. —Pan too small. —Stale baking powder. —Oven door opened frequently. 	<p>CAKE CRACKS ON TOP.</p> <ul style="list-style-type: none"> —Temperature too high. —Batter overmixed. —Too much leavening.
<p>CAKE HAS TUNNELS.</p> <ul style="list-style-type: none"> —Not enough shortening. —Overmixing after adding flour. —Used all-purpose flour. 	<p>BISCUITS, CAKES OR COOKIES ARE DARK ON THE BOTTOM AND/OR ARE PALE ON TOP.</p> <ul style="list-style-type: none"> —Oven not preheated. —Too many pans on one rack. —Used dark or heavy pans rather than shiny pans. —Pan too deep or too large. —Used incorrect rack position. —Pan too close to oven bottom. —Cookie sheet too large for oven rack. —Uneven heat distribution in oven—pans blocking air circulation or oven vent blocked. —Incorrect use of aluminum foil. —Oven door not closed tightly or opened too frequently. —Oven temperature too low.
<p>CAKE HIGH IN MIDDLE.</p> <ul style="list-style-type: none"> —Too much flour. —Temperature too high. 	
<p>CAKE IS UNEVEN.</p> <ul style="list-style-type: none"> —Pans not staggered in oven, are touching each other or the oven walls. —Batter uneven in pans. —Warped pans. —Range not level. 	

HINTS FOR SUCCESSFUL BROILING

Before broiling, trim excess fat to prevent excessive spattering and cut slashes around the outer edges of the meat to prevent the meat from curling during cooking.

Food must be placed on the broiler tray in the broiler pan to allow fat to drip to the pan below. Fat may become hot enough to ignite if directly exposed to the flame.

Place food on a cold, ungreased broiler tray.

The broiler pan can be lined with aluminum foil for ease of cleaning. If the broiler tray is lined with foil, cut open-

ings to allow fat to drip to pan below. The broiler tray is designed to keep fat from being directly exposed to the oven burner to eliminate possible fire hazards.

Place food in the rack position as suggested in the guide below. If food is placed too close to the flame, overbrowning and smoking may occur. Broiling is always done with the door closed.

Never leave a soiled broiler tray and pan in the oven after broiling. Drippings might become hot enough to ignite if exposed directly to the flame.

BROIL GUIDE

FOOD	RACK POSITION*	DONENESS	TOTAL COOKING TIME
BACON	1		4- 7 min.
BEEF PATTIES ¾-inch thick	2	Rare	12-14 min.
	2	Medium	14-16 min.
	3	Well Done	17-20 min.
STEAKS 1-inch thick	1	Rare	12-14 min.
	1	Medium	15-18 min.
	2	Well Done	20-24 min.
STEAKS 1½-inch thick	2	Rare	20-24 min.
	2	Medium	25-30 min.
	3	Well Done	32-38 min.
CHICKEN HALVES 2½-lbs.	3 (Broil at 425° F.)	Well Done	35-45 min.
FISH FILLETS 1-inch thick	1		10-13 min.
HAM SLICES 1-inch Fully Cooked Cook-Before-Eating	1		10-12 min.
	1		20-24 min.
PORK CHOPS 1-inch thick	3 (Broil at 425° F.)	Well Done	25-30 min.
LAMB CHOPS 1½-thick	2	Medium	18-20 min.
	2	Well Done	20-22 min.

*Rack position 1 is the position closest to the top of the broiler compartment.

CARE INFORMATION

Be sure the range or built-in oven is cool before removing parts for cleaning. After removing any part, be sure it is correctly replaced.

OVEN DOOR

There are two types of oven doors—lift off and nonlift off. The lift off door is identified by the two hinge slots located behind the hinge arms on the door.

To remove lift off door: Open door to the "stop" position (opened about 4-inches) and grasp door with both hands at sides of the door. Lift up evenly, at the same angle, until the door clears the hinges.

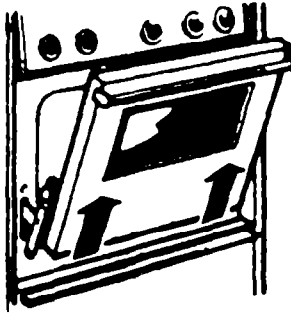

To replace door: Hold door in the same position and insert hinge openings on hinge arms. (Hinge arms are spring mounted and will slam shut against the range if accidentally hit with the door.) Lower door evenly, at the same angle as hinge, until door is seated in the original position.

CAUTION: Do not attempt to open or close door from the "stop" position until the door is completely seated on the hinges.

OVEN DOOR WINDOW

Occasionally, you may find that the window in the oven door may fog due to moisture condensing in the oven. This is especially common in humid weather or when cooking foods high in moisture. Opening the oven door a few inches during the first few minutes of preheating or cooking will allow moist air to escape and prevent the window from fogging.

OVEN

The oven(s) will have one of two types of finishes—either porcelain-enamel or the Continuous Cleaning Oven finish. The porcelain-lined oven is dark gray in color with a smooth glass-like textured surface. The Continuous Cleaning finish is a dark charcoal gray color with a rough textured surface.

See page 18 for additional information on the Continuous Cleaning Oven finish.

To clean a porcelain-lined oven: Wipe acid stains immediately with a dry cloth. Clean oven walls, bottom and door with hot soapy water. Stubborn soil can be removed with cleansing powders, plastic pads or a paste of baking soda and water. Do not use steel wool or other abrasive scouring pads for they will scratch the surface. Commercial oven cleaners can be used but follow the manufacturer's directions.

COMMERCIAL OVEN CLEANERS

When using oven cleaners, carefully follow manufacturer's directions. Wear rubber gloves to protect your hands for oven cleaners are caustic.

Use oven cleaners on the porcelain-lined oven only. Never use cleaners on the oven burner, surface burners, end panels, exterior finishes, trim parts or on the Continuous Cleaning Oven finish. These parts will be permanently damaged by the cleaner.

After using the oven cleaner, rinse oven interior and thermostat sensing device, located at the top of the oven, with a mild solution of vinegar and water.

OVEN RACKS

All ovens are equipped with two oven racks with a safety "lock-stop" position to keep racks from coming completely out of the oven when adding or removing food.

To remove rack: Be sure rack is cool. Pull rack out to the "lock-stop" position, tilt up and continue pulling until the rack is released.

To replace rack: Place rack on rack supports, tilt up and push to rear of oven. Pull rack out to "lock-stop" position to be sure rack has been properly replaced.

To clean racks: Wash with soapy water. Remove stubborn soil with cleansing powder or a soap-filled scouring pad. Rinse, dry and correctly replace rack in the oven.

OVEN BOTTOM

The oven bottom is insulated to eliminate hot spots directly above the oven burner. Eliminating the hot spots greatly increases the baking efficiency as well as the cooking capacity of the oven.

To remove oven bottom: Be sure oven bottom is cool. First remove oven racks, then loosen the two screws located along the front of the oven bottom. Slide the screws back to release the front of the oven bottom. Grasp oven bottom, lift up and pull forward until rear tabs release. Then, remove oven bottom from oven.

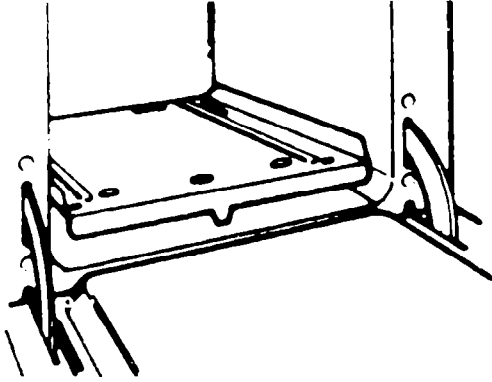

To replace oven bottom: Insert tabs into slots on the back oven wall. Lower into place, slide two screws forward and tighten. Be sure bottom is fitted into slots and screws are tight. If not correctly replaced, oven bottom may become warped and cooking results will be affected.

To clean oven bottom: Oven bottom will have the same finish as the oven. Follow cleaning instructions for cleaning oven. When cleaning oven bottom, do not allow insulation, located under the oven bottom, to become wet.

LOWER BROILER COMPARTMENT

Store broiler tray and pan in the broiler compartment when not in use to prevent possible scorching of the floor under the range when the oven is in use.

To remove drawer on 30- or 36-inch ranges: Be sure broiler is cool. Firmly grasp drawer and slide out to the first stop. Lift up and pull to the second stop. Lower drawer to the floor, grasp rear of broiler drawer and lift up.

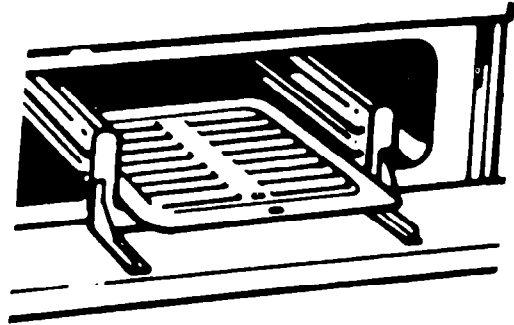

To remove drawer on 20-inch ranges: Remove broiler tray and pan. Pull metal clip, located in center of drawer floor, up about 2-inches, then pull drawer out.

To clean broiler compartment: The broiler compartment is lined with porcelain-enamel. Follow cleaning information for porcelain-lined ovens.

To clean broiler tray and pan: Remove pan and tray from broiler after use. Cool, pour off grease and place a soapy cloth over the tray and pan. Let soak to loosen soil, then wash in hot soapy water. Use a soap-filled scouring pad to remove stubborn soil. If desired, tray and pan can be cleaned in the dishwasher.

LEVELING LEGS

The range can be leveled on uneven floors by adjusting the leveling leg screws in the bottom of the range. Leveling legs are located in the four corners of the range. Remove broiler compartment drawer and adjust as necessary with a screwdriver.

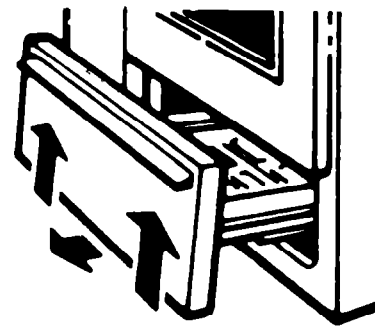

GENERAL CLEANING CHART

PARTS	CLEANING AGENTS	DIRECTIONS
Broiler tray & pan	Soap & Water Plastic scouring pad Soap filled scouring pad	Remove from broiler after use. Allow to cool, then pour off grease. Place soapy cloth over tray and pan, let soak to loosen soil. Wash in soapy water. Use soap filled scouring pad to remove stubborn soil. Clean in dishwasher if desired.
Burner box	Soap & Water Appliance wax	Burner box, located under cooktop, should be cleaned frequently to remove spillovers. If soil is not removed and is allowed to accumulate, it may damage the finish. To clean, remove surface burners and clean with soap and water, rinse and dry. If desired, an application of wax can be used.

GENERAL CLEANING CHART (Cont'd.)

Control Knobs	Mild detergent & water	To remove knobs for cleaning, gently pull forward. Wash in mild detergent and water. Do not use abrasive cleaning agents. They will scratch finish and remove markings. Rinse, dry and replace.
Glass—backguard Oven Window	Soap & Water Paste of baking soda & water Window cleaning fluid or ammonia	Wash with cloth wrung out in soapy water. Remove stubborn soil with paste of baking soda and water. To avoid inside staining of oven door glass, do not oversaturate cloth. Do not use abrasive materials such as scouring pads, steel wool or powdered cleaning agents. They will damage glass. Rinse with clear water and dry.
End panels, polyester	Soap & water	Wash with soap and warm water. Do not use abrasive cleaning materials. They will scratch finish. Never use oven cleaners.
Grates	Detergent & water Soap filled scouring pad	Grates are made of porcelain coated steel. They can be cleaned at the sink with detergent and water or in the dishwasher. Clean stubborn soil with soap filled scouring pad.
Metal finishes— Aluminum—backguard base, control panel Chrome & stainless steel—trim parts	Soap & water Paste of baking soda & water	Wash with soap and water. Remove stubborn soil with paste of baking soda and water. Do not use abrasive or caustic agents. They will damage the finish. Restore luster on brushed chrome only, apply small amount of mineral oil and let stand 5 minutes. Remove excess oil with a clean cloth.
Oven Rack	Soap & water Cleansing powders & plastic pads Soap filled scouring pad	Clean with soapy water. Remove stubborn soil with cleansing powder or soap filled scouring pad. Rinse and dry.
Porcelain Enamel— Exterior finishes	Mild soap & water Paste of baking soda & water	Porcelain enamel is glass fused on metal. It may crack or chip with misuse. Clean with soap and water when parts are cool. All spillovers, especially acid spillovers, should be wiped up immediately with a dry cloth. When surface is cool, clean with warm soapy water. NEVER WIPE OFF A WARM OR HOT ENAMEL SURFACE WITH A DAMP CLOTH. THIS MAY CAUSE CRACKING AND CHIPPING. Never use abrasive or caustic cleaning agents on exterior finish of range.
Porcelain-enamel Oven and Lower Broiler Compartment (See page 18 for cleaning instructions of Continuous Cleaning Oven.)	Soap & water Cleansing powders & plastic pads Commercial oven cleaner	Wipe acid stains immediately with a dry cloth. Clean oven walls and bottom with soap and water. Stubborn soil is removed with cleansing powders or plastic pad. Do not use metallic cleaning pads. They will scratch the surface. Commercial oven cleaners can be used but follow manufacturer's directions.
Reflector Pans (Chrome plated steel)	Soap & water Paste of baking soda & water Plastic scouring pad	Clean pans after each use with soap and water. Remove stubborn stains with baking soda paste and plastic scouring pad. To prevent scratching the finish, do not use abrasive cleaning agents. Rinse, dry and replace. NOTE: Pans will permanently discolor if exposed to excessive heat or if soil is allowed to bake on.
Surface burners	Soap & water Paste of baking soda & water Plastic scouring pad such as Tuffy®	Clean as necessary with warm soapy water. Remove stubborn soil by scouring with a non-abrasive plastic scouring pad and a paste of baking soda and water. Clean ports with a straight pin. Do not enlarge or distort the ports. Do not use a wooden toothpick. It may break off and clog port. DO NOT CLEAN BURNERS WITH THE FOLLOWING: Caustic cleaners, steel wool, abrasive cleaning agents, dishwasher detergent, or metal polishes. These will damage finish. Do not clean burners in dishwasher. Burners can be dried in the oven set at 140° F (60° C.). CAUTION: Burner and burner tube must be dry before use.
Vinyl Finishes Door handle Manifold panel	Soap & water	Never use abrasive or caustic cleaning agents on vinyl finishes.

SPECIAL FEATURES

CONTINUOUS CLEANING OVEN

WHAT IS THE CONTINUOUS CLEANING OVEN

The special ceramic finish of the Continuous Cleaning Oven is identified by its dark gray color and rough, porous texture. The rough texture acts to prevent grease spatters from forming beads which run down the walls leaving unsightly streaks. Rather, the rough texture absorbs spatters and allows them to spread, thus exposing a larger area to the hot oven air for faster more effective cleaning action.

Cleaning action automatically begins whenever the oven is turned on for baking or roasting. The oven **MUST** be on for cleaning to take place—no cleaning will occur when the oven is off. The special finish must be exposed to hot oven air before soil will begin to gradually reduce in size.

FACTORS AFFECTING LENGTH OF CLEANING TIME

The higher the oven temperature, the faster the cleaning action. The length of cleaning time will depend on these factors: Type of soil, amount or size of soil, oven temperature and length of time oven is in use. Time may vary from a few minutes to several hours. Soil deposited at the end of cooking may still be visible. This will usually fade with continued oven use until the soil gradually disappears or can be wiped up manually. The oven will appear presentably clean, even though some spatters may be present.

MANUALLY CLEANING HEAVY SPILLOVERS

The special finish will clean most spatters during normal oven use unless there is a heavy buildup of soil. Heavy spillovers such as pie or casserole boilovers will not clean effectively without some manual help. The crusty or varnish-like stains that form from these spillovers clog the pores and prevent the special finish from being exposed to the hot oven air. This greatly reduces the cleaning effectiveness of the finish.

These crusty or varnish-like stains must either be removed or broken up before cleaning can effectively take place.

To manually clean heavy spillovers: Brush off heavy soil with a nylon brush or plastic pad. **DO NOT USE** paper towels, cloths or sponges for the oven walls are porous and particles of these materials will rub off on the walls.

Rinse area with clear water only. Do not allow insulation under oven bottom to become wet.

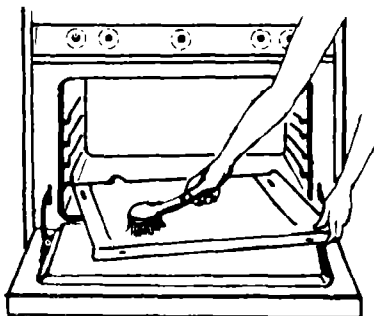

Brittle crusts or varnish-type stains can be loosened by **GENTLY** tapping stain with a wooden or plastic utensil. Brush away any loose soil that flakes off.

Remaining soil will gradually reduce with continued oven use at normal baking temperatures.

DO NOT USE ANY TYPE OF OVEN CLEANER, POWDERED CLEANSERS, SOAP, DETERGENT OR PASTE ON ANY CONTINUOUS CLEANING SURFACE. ALSO, DO NOT USE ANY ABRASIVE MATERIALS, STEEL WOOL, SHARP INSTRUMENTS OR SCRAPERS FOR THEY WILL DAMAGE THE FINISH.

Avoid spillovers by using utensils that are large enough to hold food. A cookie sheet or piece of aluminum foil, just a little larger than the pan, can be placed on the rack directly below the rack holding the utensil to catch spills.

Over a period of time, wear marks may appear on the embossed rack supports. This is normal and results from sliding the racks in and out of the oven. Wear marks will not affect the cleaning action of the oven.

NOTE: The lower broiler compartment is lined with porcelain-enamel and **NOT** with the Continuous Cleaning finish. Follow cleaning instructions on page 15.

EYE LEVEL RANGE

The smaller upper oven on the Eye Level Range will be equipped with either a conventional gas oven or a microwave oven.

Eye Level Range with Conventional Upper Oven: The Eye Level conventional oven operates the same as the larger lower oven. Because of the size and location of the upper oven, it is a handy place to cook small quantities of foods.

The smaller oven, which is very efficient for most purposes, does have some size limitations. Do not use cookie sheets or other cooking utensils that are larger than 14-inches. Large cookie sheets will block the air flow which in turn affects baking results. When baking more than one cake layer at a time, use two different rack positions for the two layers and stagger the pans so one is not directly over the other.

Eye Level Range with Microwave Oven: Refer to the Use and Care Microwave Oven Booklet for operating instructions on the microwave oven.

This range is equipped with a special, automatic fan to help keep the microwave oven cool during some cooking operations.

Do not be concerned if you hear the auxiliary fan come on during, or sometimes after, some conventional cooking operations. The fan is activated by the thermal sensor and will turn on and remain on until the air temperatures in the upper section of range are reduced to a safe level. The fan may remain on for a time after the conventional oven or surface units have been turned off.

CAUTION: To prevent permanent damage to the range parts, the range **MUST** be installed according to the Installation Instructions. Refer to the instructions for correct clearances.

OPERATION OF ANY SURFACE BURNER WITHOUT A UTENSIL IN PLACE WILL CAUSE PERMANENT DAMAGE TO THE RANGE PARTS.

PROGRAMMED OVEN COOKING

When this feature is used, cooking will begin as soon as you set the oven temperature and will continue for the length of time you set on the COOKING HOURS or HOURS TO COOK knob. At the end of the preset time, the oven automatically lowers to a keep-warm temperature and will hold this temperature until you turn the oven off.

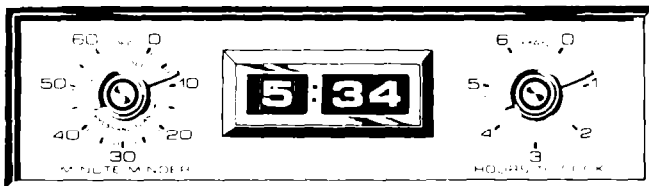

To operate this feature:

1. Select foods that cook for the same length of time and at the same temperature. Place food in the oven.
2. Turn the COOKING HOURS or HOURS TO COOK knob to the desired cooking time. The oven can be set for up to 6 (or 10 hours, depending on your model) of cooking.

For Eye Level Conventional Gas Ovens: Flip OVEN SELECTOR switch, located on the control panel, to the oven you wish to use for programmed cooking. UPPER for the upper oven and LOWER for the lower oven. Only ONE oven can be programmed at a time, the other oven can be operated manually.

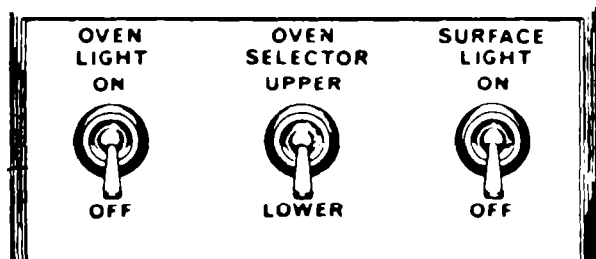

3. Turn the Oven Temperature Control to the desired setting and cooking begins. (For the Eye Level Gas Range: Turn the Oven Temperature Control for the oven selected to the desired setting.)
4. About 20 minutes before time lapses on the COOKING HOURS knob, the oven temperature will automatically reduce to a keep-warm setting. The oven will maintain this temperature until you turn the oven off.

Foods will safely hold at a keep-warm temperature for up to 4 or 5 hours, but quality, appearance and nutritional value is better if food is served within 1½ hours after cooking.

5. When food is removed from the oven, turn the Oven Temperature Control to off.

BUILT-IN OVENS ONLY: It is necessary to turn the COOKING HOURS Knob from HOLD to MANUAL or the oven will only heat up to a keep-warm temperature the next time the oven is used.

DELAY COOK AND HOLD

This feature offers you the ability to program the oven, at your convenience for up to 7 hours of cooking. At the preselected time-of-day, the oven will automatically turn on, cook the food for the preselected length of time and then reduce to a keep-warm temperature. The oven will hold this setting until you manually turn the oven off.

Before using this feature, be sure the clock is operating and is at the correct time-of-day.

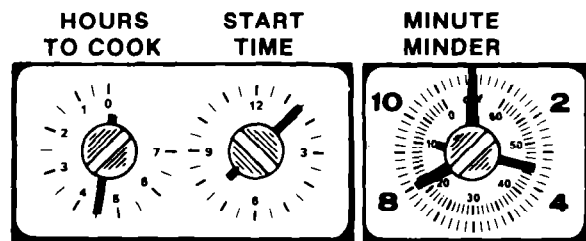

To operate this feature:

1. Select foods that cook for the same length of time and at the same temperature. Place food in the oven. Highly perishable foods such as dairy, pork, poultry, seafoods or stuffings are not recommended for delayed cooking.
2. Turn the HOURS TO COOK knob to the desired cooking time. The oven can be set for up to 7 hours of cooking.
3. Push in and turn START TIME knob to the time-of-day you wish food to begin cooking.
4. Turn the Oven Temperature Control to the desired temperature setting.

When the range clock is at the time set on the START TIME knob, the oven will automatically turn on. About 20 minutes before time lapses on the HOURS TO COOK knob, the oven will automatically reduce to a keep-warm setting. The oven will maintain this temperature until you manually turn the oven off.

5. When the food is removed from the oven:
 - Turn the Oven Temperature Control to off.
 - Turn the HOURS TO COOK knob to MANUAL.
 - Check to be sure START TIME knob is in the "out" position.

If the HOURS TO COOK knob and START TIME knob are not in the position as described in #5 above, the oven will not turn on the next time you use the oven.

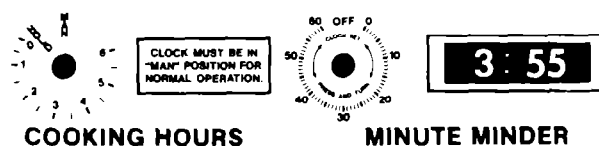

INSTALLATION AND SERVICE INFORMATION

INSTALLATION

THE INSTALLATION, ADJUSTMENT AND SERVICE OF THIS APPLIANCE MUST ONLY BE PERFORMED BY A QUALIFIED INSTALLER OR SERVICEMAN. This is to insure correct adjustments for safety and for proper performance.

1. **CLEARANCE**—Observe all instructions for minimum clearances to any combustible surfaces. These should be in accordance with information on the nameplate and with national fire laws.
2. **VENTING**—Never block vents (air openings) on the range. Vents provide air which is needed for proper operation.
3. **CARPETING**—Range should NOT be installed directly over kitchen carpeting unless an insulating pad or ¼-inch thick plywood is placed between the range and carpet.
4. **TYPE OF GAS**—There are two major types of gas—Natural and LP (Bottled). Ranges adjusted for one type of gas CANNOT be used with the other type of gas until ADJUSTMENTS ARE FIRST MADE BY A QUALIFIED SERVICEMAN.

LOCATION OF NAMEPLATE

The model and serial numbers for this appliance are found on the nameplate. These numbers must be used when requesting service from your dealer, serviceman or from us. Please record these numbers in the space provided on the inside front cover.

The nameplate is located under the cooktop on the left side wall of the burner box or near the center rear of the burner box. On built-in ovens, the nameplate is located on the main front oven frame.

ELECTRICAL CONNECTIONS ON A GAS APPLIANCE

ALWAYS DISCONNECT POWER TO RANGE BEFORE SERVICING.

Ranges equipped with electrical power have a three-prong grounding plug. FOR PERSONAL SAFETY THIS RANGE MUST BE PROPERLY GROUNDED. THE THREE-PRONG PLUG MUST BE PLUGGED DIRECTLY INTO A PROPERLY GROUNDED THREE-PRONG-TYPE WALL RECEPTACLE.

IF A TWO-PRONG-TYPE WALL RECEPTACLE IS ENCOUNTERED, **IT IS THE PERSONAL RESPONSIBILITY OF THE OWNER TO HAVE IT REPLACED WITH A PROPERLY GROUNDED THREE-PRONG-TYPE WALL RECEPTACLE.** THE THREE-PRONG GROUNDING PLUG IS FOR YOUR PROTECTION AGAINST SHOCK HAZARDS.

DO NOT REMOVE THE THIRD GROUNDING PRONG FROM THE POWER CORD PLUG.

DISCONNECTING ELECTRICAL POWER ON A GAS APPLIANCE

There are two ways to disconnect electrical power to a gas appliance. Either unplug the three-prong plug at the wall receptacle or unplug the range power disconnect plug, located under the cooktop behind the right rear burner, by pulling up.

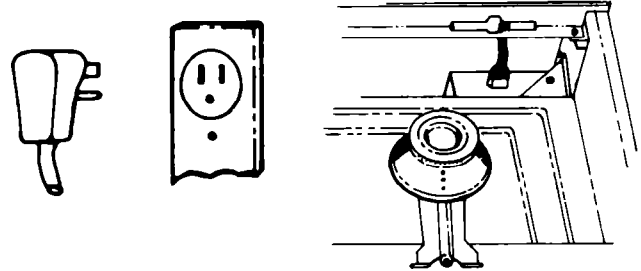

On built-in ovens, the disconnect plug is located under the bottom plate in the broiler compartment on the right side of the compartment.

PRESSURE REGULATORS

Regulators maintain the pressure of the gas coming into the range unless the pressure in the line drops below normal. By controlling this pressure, the size and appearance of the burner flame will remain constant. If you should move to a new location or change fuels, contact your serviceman to adjust the range or built-in unit to the new fuel.

If you need service or assistance, we suggest you follow these four steps:

1. Before calling for assistance...

Performance problems often result from little things you can find and fix yourself without tools of any kind.

If a surface burner fails to light:

- Is the pilot lit?
- Is the unit connected to electrical power (Solid State Ignition)?
- Did you check the fuse or circuit breaker (Solid State Ignition)?
- Are burner ports clogged? (See page 7.)
- Is the burner correctly rated? (Call for service.)

If burner flames are uneven:

- Are burner ports clogged? (See page 7.)

If surface burner flames lift off ports, are yellow, or are noisy when turned off:

- The air/gas mixture may be incorrect. (Call for service.)

If a pilot will not stay lit:

- The burner and/or pilot may be out of adjustment. (Call for service.)

If an oven burner does not light:

- Is the pilot lit?
- Is the temperature control turned to a setting?
- Is unit connected to electrical power (Solid State Ignition)?
- Did you check the fuse or circuit breaker (Solid State Ignition)?

If the oven temperature seems to be inaccurate:

- Did you read pages 12 and 13?
- Has the oven thermostat sensing device slipped out of the holding clips?
- Is the oven calibration or burner out of adjustment? (Call for service.)

If the clock or lights do not work:

- Is the unit connected to electrical power?
- Did you check the fuse or circuit breaker?
- Are bulbs burned out? (See page 9.)

If soil is visible on continuous-cleaning oven finish:

- The special finish is designed to reduce oven soil gradually during normal baking or roasting. It is not designed to keep your oven spotless...only presentably clean.
- The door is cooler than oven walls. Soil will be more visible on the door than on other areas of the oven.

If cooking results aren't what you expect:

- Is the oven level?
- Are you using utensils recommended on page 12?
- Have you preheated the oven as the recipe calls for?
- Are the pans the size called for in the recipe?
- Are you following a tested recipe from a reliable source?

See Pages 12 and 13 for more information on cooking problems and how to solve them.

2. If you need assistance* ...

Call the Whirlpool COOL-LINE® service assistance telephone number. Dial free from:

Continental U.S. (800) 253-1301
Michigan (800) 632-2243
Alaska & Hawaii (800) 253-1121

and talk with one of our trained Consultants. The Consultant can instruct you in how to obtain satisfactory operation from your appliance or, if service is necessary, recommend a qualified service company in your area.

3. If you need service* ...



Whirlpool has a nationwide network of franchised TECH-CARE® Service Companies. TECH-CARE service technicians are trained to fulfill the product warranty and provide after-warranty service, anywhere in the United States. To locate TECH-CARE service in your area, call our COOL-LINE service assistance telephone number (see Step 2) or look in your telephone directory Yellow Pages under:

**APPLIANCES—HOUSEHOLD—
MAJOR—SERVICE & REPAIR**

WHIRLPOOL APPLIANCES
FRANCHISED TECH-CARE SERVICE
SERVICE COMPANIES
XYZ SERVICE CO.
123 Maple 999-9999

**ELECTRICAL APPLIANCES—
MAJOR—REPAIRING & PARTS**

WHIRLPOOL APPLIANCES
FRANCHISED TECH-CARE SERVICE
SERVICE COMPANIES
XYZ SERVICE CO.
123 Maple 999-9999

OR

**OR
WASHING MACHINES, DRYERS
& IRONERS—SERVICING**

WHIRLPOOL APPLIANCES
FRANCHISED TECH-CARE SERVICE
SERVICE COMPANIES
XYZ SERVICE CO.
123 Maple 999-9999



4. If you have a problem* ...

Call our COOL-LINE service assistance telephone number (see Step 2), and talk with one of our Consultants, or if you prefer, write to:

Mr. Guy Turner, Vice President
Whirlpool Corporation
Administrative Center
2000 US-33 North
Benton Harbor, MI 49022

*If you must call or write, please provide: model number, serial number, date of purchase, and a complete description of the problem. This information is needed in order to better respond to your request for assistance.



FSP is a registered trademark of Whirlpool Corporation for quality parts. Look for this symbol of quality whenever you need a replacement part for your Whirlpool appliance. FSP replacement parts will fit right and work right, because they are made to the same exacting specifications used to build every new Whirlpool appliance.



Making your world a little easier.

Part No. 878072/OB-039-018-99

Printed in U.S.A.

rs, Refrigerator-Freezers, Ice Makers, Dishwashers, Built-In Ovens and Surface Units, Ranges, Microwave Ovens, Compactors, Room Air Conditioners, Dehumidifiers, Automatic Washers, Clothes Dryers, Freezer

