

Use and Care Guide



TO THE INSTALLER: PLEASE LEAVE THIS INSTRUCTION BOOK WITH THE UNIT.

TO THE CONSUMER: PLEASE READ AND KEEP THIS BOOK FOR FUTURE REFERENCE.

KitchenAid*

Table of Contents (complete)	2
A Note to You	3
Range Safety	4-6
Parts and Features	7
Using and Caring for Your Cooktop	11
Using and Caring for Your Oven	20
Using EASY CONVECT* Conversion	44
Using the Self- Cleaning Cycle	60
Troubleshooting	64
Requesting Assistance or Service	67
Index	70
Warranty	72

In the U.S.A. for assistance or service, call the Consumer Assistance Center:

1-800-422-1230

In Canada for assistance or service, see page 68.

KITCHENAID* THERMAL-CONVECTION* Gas Freestanding and Slide-In Ranges

PART NO. 9752684 Rev. A

Models: YKGRT507 YKGST307
KGRT507 KGST307

Table of Contents

A Note to You	3	Adjusting oven temperature	37
Range Safety	4-6	Using the temperature probe	39
Parts and Features	7	Using CONVECT FULL MEAL	42
Feature locations	7	Using EASY CONVECT* Conversion	44
The oven vent	9	Broiling	46
The storage drawer	9	Convection broiling	48
The anti-tip bracket	10	Timed cooking	51
Using and Caring for Your Cooktop	11	Dehydrating	54
Using the surface burners	11	Raising (proofing) bread	56
Energy saving tips	14	Cleaning your oven and controls	57
Cookware tips	14	Using and replacing the oven light(s) ...	59
Caring for your cooktop	15	Using the Self-Cleaning Cycle	60
Using and replacing the surface light	18	Before you start	60
Using and Caring for Your Oven	20	Before setting the controls	61
Using the electronic oven control	20	Setting the controls	61
Oven settings	28	For best cleaning results	63
Setting the clock	29	How the cycle works	63
Using the timer	30	Troubleshooting	64
Baking or convection baking	31	Requesting Assistance or Service	67
Roasting	33	Index	70
Cooking tips	34	Warranty	72

WARNING: If the information in this manual is not followed exactly, a fire or explosion may result causing property damage, personal injury or death.

- Do not store or use gasoline or other flammable vapors and liquids in the vicinity of this or any other appliance.
- **WHAT TO DO IF YOU SMELL GAS**
 - Do not try to light any appliance.
 - Do not touch any electrical switch; do not use any phone in your building.
 - Immediately call your gas supplier from a neighbor's phone. Follow the gas supplier's instructions.
 - If you cannot reach your gas supplier, call the fire department.
- Installation and service must be performed by a qualified installer, service agency or the gas supplier.

A Note to You

Thank you for buying a KITCHENAID appliance!*

KitchenAid designs the best tools for the most important room in your house. To ensure that you enjoy many years of trouble-free operation, we developed this Use and Care guide. It contains valuable information concerning how to operate and maintain your new appliance properly and safely. Please read it carefully.

Also, please complete and mail the enclosed Product Registration Card.

In the U.S.A.

For assistance or service

Call the Consumer Assistance Center toll free **1-800-422-1230**

Throughout Canada for assistance

Call the Consumer Assistance Center toll free **1-800-461-5681**
8:30 a.m. – 6 p.m. (EST)

Throughout Canada for service **see page 68**

If you need assistance or service, first see the “Troubleshooting” section of this book. After checking “Troubleshooting,” additional help can be found by checking the “Requesting Assistance or Service” section, or by calling one of the telephone numbers above.

When calling, you will need to know your appliance’s complete model number and serial number. You can find this information on the model and serial number label (see diagram in the “Parts and Features” section).

Keep this book and the sales slip together in a safe place for future reference. **You must provide proof of purchase or installation date for in-warranty service.**

Model Number _____	Builder/Dealer Name _____
Serial Number _____	Address _____
Date Installed _____	Phone _____

	⚠ WARNING
	Tip Over Hazard A child or adult can tip the range and be killed. Connect anti-tip bracket to rear range foot. Reconnect the anti-tip bracket, if the range is moved. See the installation instructions for details. Failure to follow these instructions can result in death or serious burns to children and adults.

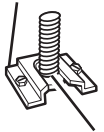
Anti-Tip Bracket  Range Foot	Making sure the anti-tip bracket is installed: <ul style="list-style-type: none">• Slide range forward.• Look for the anti-tip bracket securely attached to floor.• Slide range back so rear range foot is under anti-tip bracket.
---	---

Range Safety

Your safety and the safety of others is very important.

We have provided many important safety messages in this manual and on your appliance. Always read and obey all safety messages.



This is the safety alert symbol.

This symbol alerts you to hazards that can kill or hurt you and others.

All safety messages will be preceded by the safety alert symbol and the word "DANGER" or "WARNING." These words mean:

⚠ DANGER

You will be killed or seriously injured if you don't follow instructions.

⚠ WARNING

You can be killed or seriously injured if you don't follow instructions.

All safety messages will identify the hazard, tell you how to reduce the chance of injury, and tell you what can happen if the instructions are not followed.

IMPORTANT SAFETY INSTRUCTIONS

WARNING: To reduce the risk of fire, electrical shock, injury to persons, or damage when using the range, follow basic precautions, including the following:

- **WARNING** – TO REDUCE THE RISK OF TIPPING OF THE RANGE, THE RANGE MUST BE SECURED BY PROPERLY INSTALLED ANTI-TIP DEVICES. TO CHECK IF THE DEVICES ARE INSTALLED PROPERLY, SLIDE RANGE FORWARD, LOOK FOR ANTI-TIP BRACKET SECURELY ATTACHED TO FLOOR, AND SLIDE RANGE BACK SO REAR RANGE FOOT IS UNDER ANTI-TIP BRACKET.
- **CAUTION** – Do not store items of interest to children in cabinets above a range or on the backguard of a range – children climbing on the range to reach items could be seriously injured.
- Proper Installation – The range, when installed, must be electrically grounded in accordance with local codes or, in the absence of local codes, with the *National Electrical Code, ANSI/NFPA 70*. Be sure the range is properly installed and grounded by a qualified technician.
- This range is equipped with a three-prong grounding plug for your protection against shock hazard and should be plugged directly into a properly grounded receptacle. Do not cut or remove the grounding plug from this plug.
- Disconnect the electrical supply before servicing the appliance.
- Never Use the Range for Warming or Heating the Room.

– SAVE THESE INSTRUCTIONS –

IMPORTANT SAFETY INSTRUCTIONS

- **Do Not Leave Children Alone** – Children should not be left alone or unattended in area where the range is in use. They should never be allowed to sit or stand on any part of the range. Injuries may result from the misuse of appliance doors or drawers such as stepping, leaning, or sitting on the doors or drawers.
- **Wear Proper Apparel** – Loose-fitting or hanging garments should never be worn while using the range.
- **User Servicing** – Do not repair or replace any part of the range unless specifically recommended in the manual. All other servicing should be referred to a qualified technician.
- **Maintenance** – Keep range area clear and free from combustible materials, gasoline, and other flammable vapors and liquids.
- **Storage in or on the Range** – Flammable materials should not be stored in an oven or near surface units.
- **Do Not Use Water on Grease Fires** – Smother fire or flame or use dry chemical or foam-type extinguisher.
- **Use Only Dry Potholders** – Moist or damp potholders on hot surfaces may result in burns from steam. Do not let potholder touch hot heating elements. Do not use a towel or other bulky cloth.
- **DO NOT TOUCH SURFACE UNITS OR AREAS NEAR UNITS** – Surface units may be hot even though they are dark in color. Areas near surface units may become hot enough to cause burns. During and after use, do not touch, or let clothing or other flammable materials contact surface units or areas near units until they have had sufficient time to cool. Among those areas are the cook-top and surfaces facing the cook-top.
- **Use Proper Pan Size** – The range is equipped with one or more surface units of different size. Select utensils having flat bottoms large enough to cover the surface unit heating element. The use of undersized utensils will expose a portion of the heating element to direct contact and may result in ignition of clothing. Proper relationship of utensil to burner will also improve efficiency. Top burner flame size should be adjusted so it does not extend beyond the edge of the cooking utensil.
- **Never Leave Surface Units Unattended at High Heat Settings** – Boilover causes smoking and greasy spillovers that may ignite.
- **Make Sure Reflector Pans or Drip Bowls Are in Place** – Absence of these pans or bowls during cooking may subject wiring or components underneath to damage.
- **Protective Liners** – Do not use aluminum foil to line surface unit drip bowls or oven bottoms, except as suggested in the manual. Improper installation of these liners may result in a risk of electric shock, or fire.
- **Glazed Cooking Utensils** – Only certain types of glass, glass/ceramic, ceramic, earthenware, or other glazed utensils are suitable for range-top service without breaking due to the sudden change in temperature.
- **Utensil Handles Should Be Turned Inward and Not Extend Over Adjacent Surface Units** – To reduce the risk of burns, ignition of flammable materials, and spillage due to unintentional contact with the utensil, the handle of a utensil should be positioned so that it is turned inward, and does not extend over adjacent surface units.

– SAVE THESE INSTRUCTIONS –

continued on next page



IMPORTANT SAFETY INSTRUCTIONS

- Use Care When Opening Door – Let hot air or steam escape before removing or replacing food.
- Do Not Heat Unopened Food Containers – Build-up of pressure may cause container to burst and result in injury.
- Keep Oven Vent Ducts Unobstructed.
- Placement of Oven Racks – Always place oven racks in desired location while oven is cool. If rack must be moved while oven is hot, do not let potholder contact hot heating element in oven.
- **DO NOT TOUCH HEATING ELEMENTS OR INTERIOR SURFACES OF OVEN** – Heating elements may be hot even though they are dark in color. Interior surfaces of an oven become hot enough to cause burns. During and after use, do not touch, or let clothing or other flammable materials contact heating elements or interior surfaces of oven until they have had sufficient time to cool. Other surfaces of the appliance may become hot enough to cause burns – among these surfaces are oven vent openings and surfaces near these openings, oven doors, and windows of oven doors.

For self-cleaning ranges –

- Do Not Clean Door Gasket – The door gasket is essential for a good seal. Care should be taken not to rub, damage, or move the gasket.
- Do Not Use Oven Cleaners – No commercial oven cleaner or oven liner protective coating of any kind should be used in or around any part of the oven.
- Clean Only Parts Listed in Manual.
- Before Self-Cleaning the Oven – Remove broiler pan and other utensils. Wipe off all excessive spillage before initiating the cleaning cycle.

For units with ventilating hood –

- Clean Ventilating Hoods Frequently – Grease should not be allowed to accumulate on hood or filter.
- When flaming foods under the hood, turn the fan off. The fan, if operating, may spread the flame.

– SAVE THESE INSTRUCTIONS –

Parts and Features

This section tells you what features your range has and where they are located. It also discusses some convenience features that you should know about, but which are not needed to operate the range. Please review this information before using your range. To help you find information on specific parts or features quickly, page references are included.

Feature locations

Models KGST307 and YKGST307

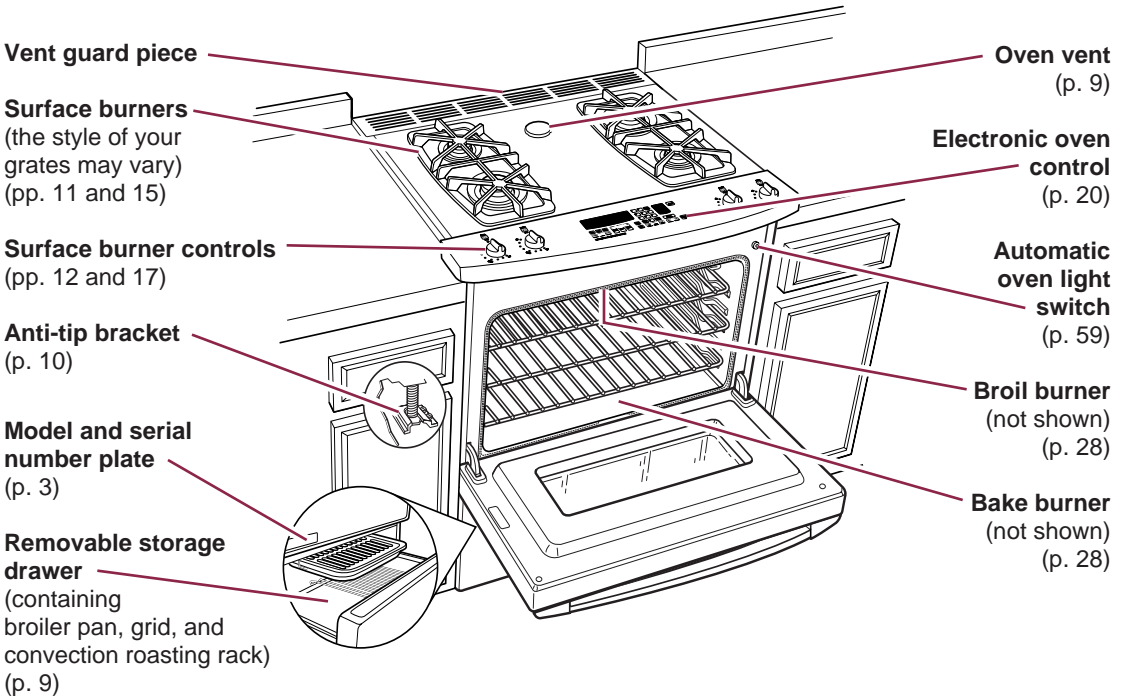

Surface burner controls

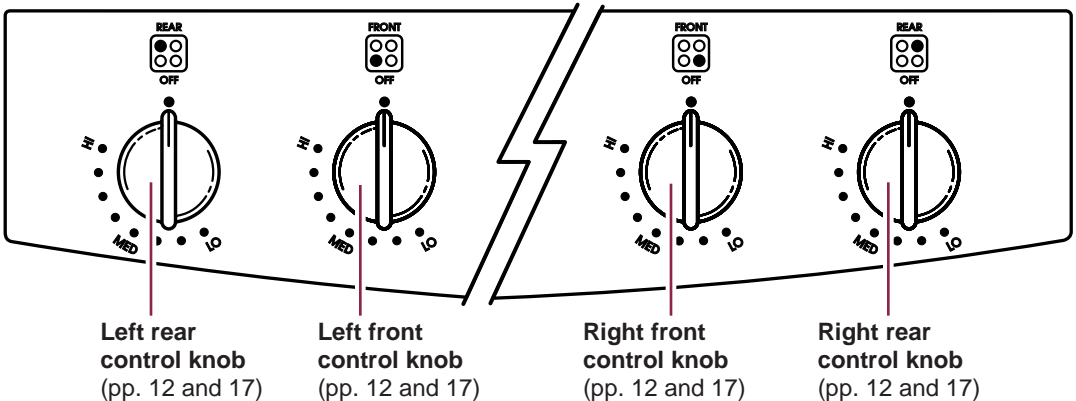



Models KGRT507 and YKGRT507

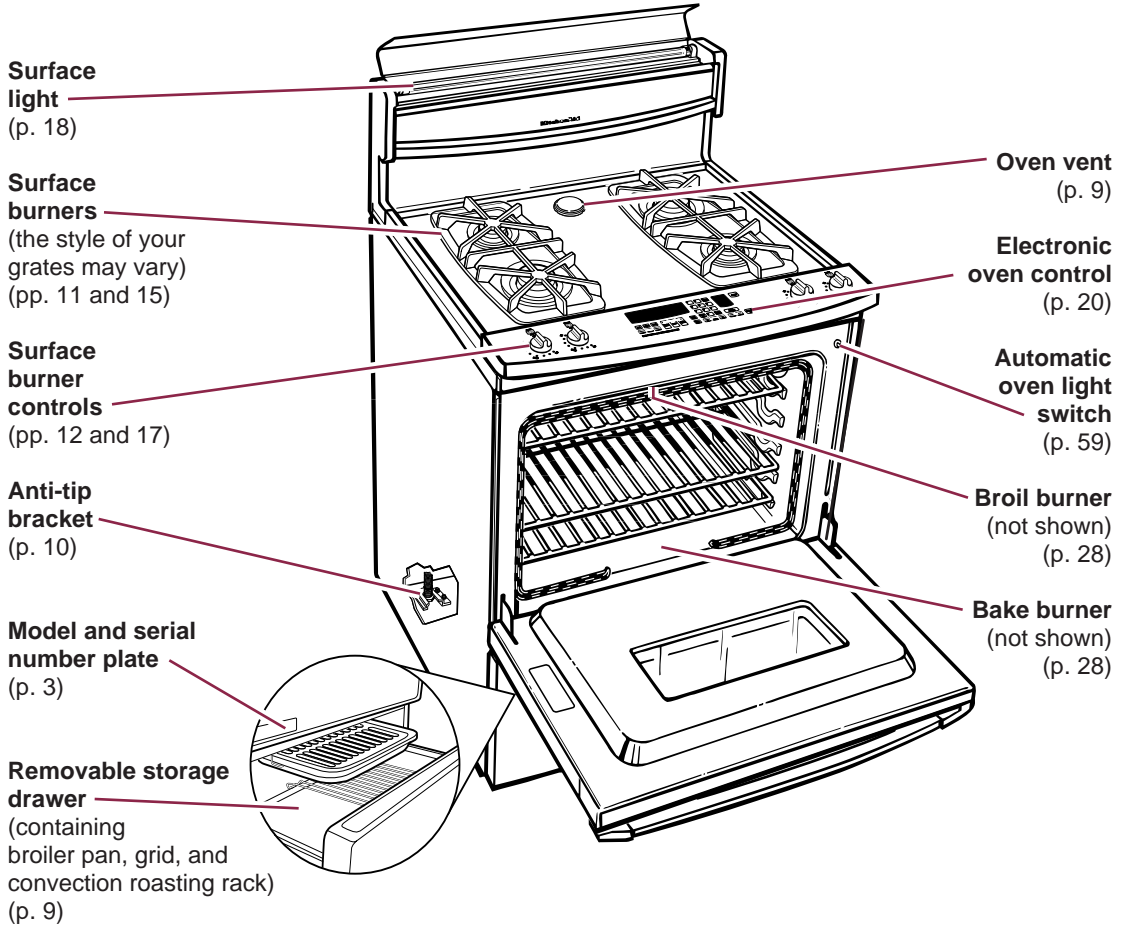

Surface burner controls

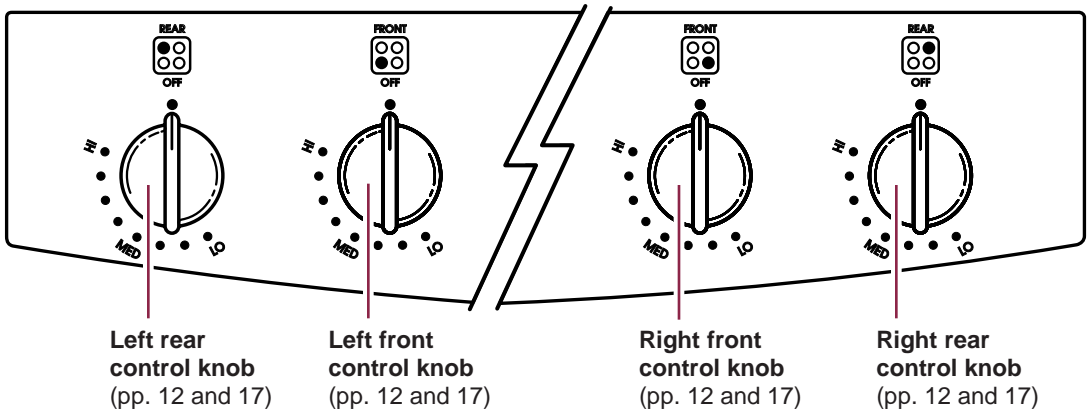



The oven vent

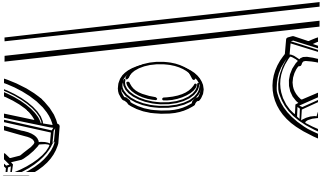

Hot air and moisture escape from the oven through a vent in the center rear of the cooktop. **Do not block the vent by using large pans or covers.** Poor baking/roasting and combustion can result.

⚠ WARNING



Burn Hazard

Use pot holders when touching items left near oven vent.

Failure to do so can result in burns.

The storage drawer

You can remove the storage drawer to make it easier to clean under the range. **Use care when handling the drawer.**

Removing the storage drawer:

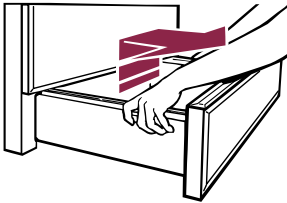

1. **Empty** drawer of any pots and pans before removing drawer. **Use** recessed area on top edge of drawer to pull drawer straight out to the first stop. **Lift** front and **pull out** to the second stop.
2. **Lift** back slightly and **slide** drawer all the way out.

Replacing the storage drawer:

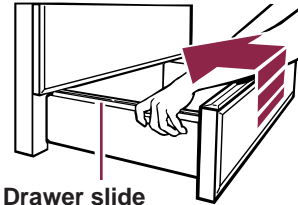

Drawer slide rail

1. **Fit** ends of drawer slide rails into the drawer guides on both sides of opening.
2. **Lift** drawer front and **press in** until metal stops on drawer slide rails clear white stops on drawer guides. **Lift** drawer front again to clear second stop and **slide** drawer closed.



The anti-tip bracket

The range will not tip during normal use. However, tipping can occur if you apply too much force or weight to the open door without the anti-tip bracket properly secured.

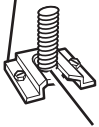
	<p style="text-align: center;">⚠ WARNING</p> <p style="text-align: center;">Tip Over Hazard</p> <p>A child or adult can tip the range and be killed.</p> <p>Connect anti-tip bracket to rear range foot.</p> <p>Reconnect the anti-tip bracket, if the range is moved.</p> <p>See the installation instructions for details.</p> <p>Failure to follow these instructions can result in death or serious burns to children and adults.</p>
<p>Anti-Tip Bracket</p>  <p style="text-align: center;">Range Foot</p>	<p>Making sure the anti-tip bracket is installed:</p> <ul style="list-style-type: none">• Slide range forward.• Look for the anti-tip bracket securely attached to floor.• Slide range back so rear range foot is under anti-tip bracket.

Using and Caring for Your Cooktop

This section tells you how to operate the controls to the cooktop. It also discusses how the sealed gas burner cooktop works, and includes tips on how to cook with and maintain the cooktop.

Using the surface burners

Your cooktop has sealed gas burners with an auto-reignition system. The sealed burners spread the heat evenly across the bottom of the cookware and provide infinite heat control. The auto-reignition system senses when a burner flame has gone out and will automatically reignite that burner.

IMPORTANT: Your cooktop is factory-set for use with Natural Gas. If you wish to use L.P. gas, an L.P. Gas Conversion Kit is included with your new range. See the appropriate section of the Installation Instructions for details on making this conversion.

When to use the right rear and left front burners:

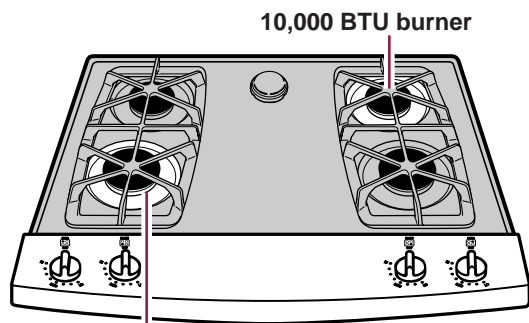

10,000 BTU burner

Use these burners for cooking large quantities of food, deep-fat frying, or cooking with large cookware.

When to use the left rear and right front burners:

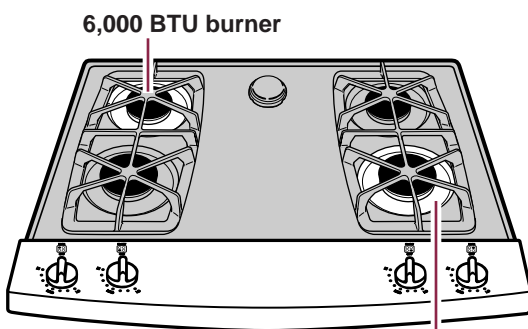

6,000 BTU burner

Use these burners for simmering or for cooking smaller quantities of food requiring small cookware.



Using and Caring for Your Cooktop

!WARNING

Carbon Monoxide Poisoning Hazard
Do not operate with a yellow flame.
Doing so can result in death, heart attack, or convulsions.

How to use the surface burners:



1. **Grasp** the control knob.
2. **Push down** and **turn** to HI. The electric spark ignitor will ignite the gas flowing into the burner. When you hear a clicking sound, you know that the ignitors are working. Gas is flowing as long as knob is not set at OFF.
3. **When the burner is lit, turn** the control knob to the desired flame setting. (See the guide under “Burner heat settings” later in this section.) You can turn the knobs to any of the marked settings. The ignitor will turn off and the clicking will stop when the burner ignites.

NOTES:

- **The ignitors** may click a number of times before burner lights. This is normal.
- **All four burner ignitors** will spark regardless of which burner you are using.
- **Visually check** that the burner has lit. If the burner does not ignite, listen for the clicking sound. If you do not hear the ignitor click, **TURN THE BURNER OFF.** Check that the service cord is placed firmly in the wall receptacle. Check for a tripped circuit breaker or blown fuse.

Check that the control knob is pressed completely down on valve shaft. **If the spark ignitor still fails to operate, call your nearest authorized KitchenAid servicing outlet.**

Proper grounding and polarity are necessary for correct operation of the electric ignition system. If the wall receptacle does not provide correct polarity, the ignitor will become grounded and click every once in a while, even after the burner has ignited. A qualified electrician should check the wall receptacle to see if it is wired with correct polarity.

!WARNING



Fire Hazard

Do not let the burner flame extend beyond the edge of the pan.
Turn off all controls when not cooking.
Failure to follow these instructions can result in death or fire.

Burner heat settings

Use correct burner heat settings (see chart later in this section). If the heat setting is too high, it can:

- **Char** bacon and cause curling.
- **Make** eggs tough and crisp at the edges.
- **Toughen** liver, fish, and seafood.
- **Scorch** delicate sauces and custards.
- **Cause** a boilover.



Until you get used to the settings, use the following as a guide. For best results, start cooking at the high setting; then turn the control knob down to continue cooking.

SETTING	RECOMMENDED USE
HI	<ul style="list-style-type: none">• To start foods cooking.• To bring liquids to a boil.
MED	<ul style="list-style-type: none">• To hold a rapid boil.• To fry chicken or pancakes.• For gravy, pudding, and icing.• To cook large amounts of vegetables.
LO	<ul style="list-style-type: none">• To keep food warm until ready to serve.

In case of a prolonged power failure

Surface burners can be manually lighted.

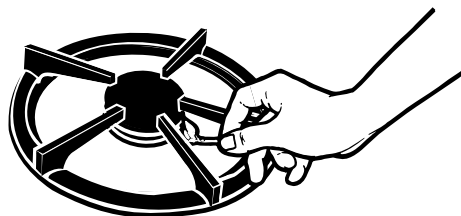

1. Hold a lit match near a burner and turn the control knob to the HI position.



2. After the burner lights, turn the control knob to the desired setting.

NOTE: Do not leave the cooktop unattended when cooking during a power failure. The auto-reignition feature of your cooktop will not operate during a power failure.



Energy saving tips

Although the energy used for cooking is usually a very small percentage of the total energy used in the home, cooking energy can be used efficiently. Here are some tips to help you save energy when using your range:

- **Use** pans with flat bottoms, straight sides, and tight-fitting lids.

- **Cook** with a minimum of liquid or fat to help shorten cooking time.
- **Start** food on higher heat settings, then set surface burner control on low to finish cooking.
- **Turn on** the surface burner only after placing filled pan on the burner.

Cookware tips



- **NOTE:** For best results and greater fuel efficiency, use only flat-bottomed cookware in good condition.
- **The pan** should have straight sides and a tight-fitting lid.
- **Be sure pans** do not tip, whether they are full or empty.
- **Pans** should be easy to clean. Check to be sure there are no crevices, rough edges, or areas where food might collect.
- **Use cookware** only as instructed in the cookware's user instructions. This is very important for glass cookware because some can be used only in the oven. Pans marked as flameware can be used on surface burners.
- **Choose medium to heavy gauge** (thickness) pans that are fairly lightweight.
- **The pan material** (metal or glass) affects how fast heat transfers from the surface burner through the pan material and how evenly heat spreads over the pan bottom. Choose pans that provide the best cooking results.
- **Handles** should be made of sturdy, heat-resistant material and be securely attached to the pan.

NOTE: Do not leave empty cookware, or cookware which has boiled dry, on a hot surface burner. The cookware could overheat, causing damage to the cookware or surface burner.

Home canning information

The large diameter of most water-bath or pressure canners combined with high heat settings for long periods of time can cause damage to the cooktop.

To protect your cooktop:



- **Use a canner/pan which can be centered over the surface burner.** Large diameter canners/pans, if not properly centered, trap heat and can cause damage to the cooktop.
- **Do not place canner** on two surface burners at the same time. Too much heat will build up and will damage the cooktop.
- **Start with hot water.** This reduces the time the control is set on high. Reduce heat setting to lowest position needed to keep water boiling.
- **Refer** to your canner manual for specific instructions.



Caring for your cooktop

Your cooktop is designed for ease of care. You can do most cleaning with items found around the home. Cleaning your cooktop whenever spills or soiling occur will help to keep it looking and operating like new.

NOTES:

- **Before cleaning** make sure all controls are off and the cooktop is cool.
- **Do not obstruct** the flow of combustion and ventilation air.
- **If knobs are removed** while cleaning, be careful not to spill liquids through holes in the control area.
- **Be careful** not to allow moisture to collect in control area. Moisture could cause ignitor switches to fail.

Surface burners

- **The burner caps** should be routinely removed and cleaned. Always clean burner caps after a spillover. Keeping the burner caps clean prevents improper ignition and an uneven flame.
- **For proper flow** of gas and ignition of the burner, **DO NOT ALLOW SPILLS, FOOD, CLEANING AGENTS, OR ANY OTHER MATERIAL TO ENTER THE GAS TUBE OPENING.**
- **Occasionally check** the burner flames for proper size and shape as shown later in this section. A good flame is blue in color. If flames lift off ports, are yellow, or are noisy when turned off, you may need to clean the burners.

NOTE: To check oven burner flames for proper size and shape, see the Installation Instructions also included with the range.

To clean burners and burner caps:

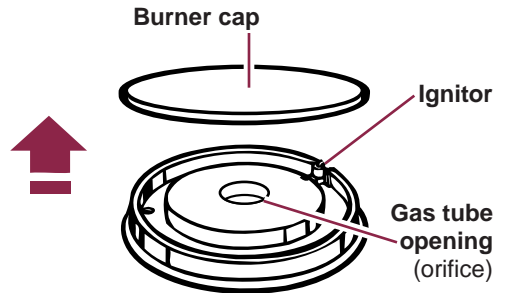

1. **Lift** the burner cap straight up from the burner base.
2. **Clean** burner cap with warm, soapy water and a sponge. For stubborn stains, clean with a mildly abrasive plastic scrubbing pad and powdered cleanser. Do not clean burner cap in dishwasher.
3. **If the gas tube opening** or the orifice, located inside the opening, has become soiled or clogged, **use** a cotton swab or a soft cloth to clean the area.
4. **If ports are clogged, clean** with a straight pin. **Do not enlarge or distort port. Do not leave anything stuck in the ports.**
5. **After cleaning** the gas tube opening and ports, **replace** the burner cap. **To replace burner cap, make sure** cap is properly aligned and leveled.
6. **Check** the burner after cleaning for proper lighting.



Adjusting the height of top burner flames

⚠ WARNING

Carbon Monoxide Poisoning Hazard
Do not operate with a yellow flame.
Doing so can result in death, heart attack, or convulsions.

The LO burner flame should be a steady blue flame approximately $\frac{1}{4}$ inch (6 mm) high. It can be adjusted using the adjustment screw in the center of the valve stem. The valve stem is located directly underneath the control knob.

To adjust the flame height follow the instructions below:

1. **Turn** the control knob to "LO."
2. **Remove** the control knob. (If there is not an adjustment screw underneath the knob the flame height is not adjustable.)
3. **Hold** the valve stem with a pair of pliers. The screw is located in the center of the valve stem. Use a small flat head screwdriver to turn the screw until the flame is the proper size.
4. **Replace** the control knob.
5. **Test** the flame by turning the control from "LO" to "HI," checking the flame at each setting.

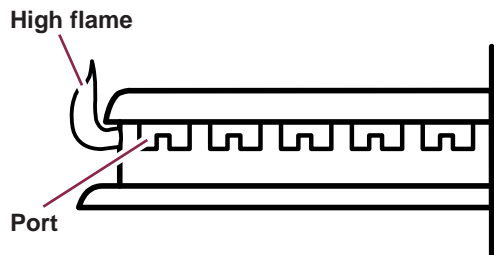
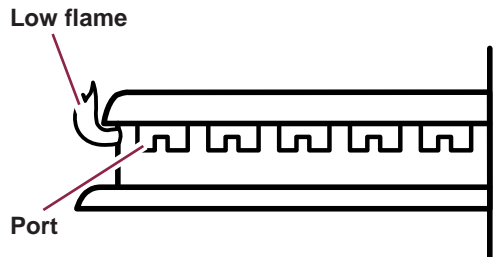
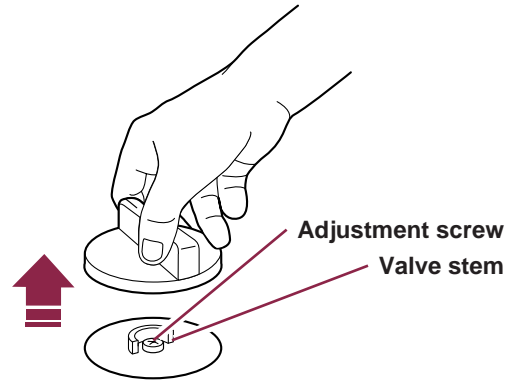



	! WARNING
	<p>Explosion Hazard</p> <p>Do not store flammable materials such as gasoline near this appliance.</p> <p>Doing so can result in death, explosion, or fire.</p>

Cleaning your cooktop

PART	WHAT TO USE	HOW TO CLEAN
Control knobs	Sponge and warm, soapy water	<ul style="list-style-type: none"> • Turn knobs to OFF and pull straight away from control panel. • Wash, rinse, and dry thoroughly. Do not soak. • Do not use steel wool or abrasive cleansers. They may damage the finish of the knobs. • Replace knobs. Make sure all knobs point to OFF.
Tempered glass surface	Sponge and warm, soapy water OR Paper towel and spray glass cleaner	<ul style="list-style-type: none"> • Remove grates. • Wash, wipe with clean water, and dry thoroughly. • Use nonabrasive, plastic scrubbing pad on heavily soiled areas. • Do not use steel wool, abrasives, or harsh cleansers. They may damage the finish. • If you use soap or detergent solutions, wipe thoroughly to prevent filmy residue. <p>NOTE: When cleaning cooktop with knobs removed, do not allow water to run down inside unit.</p> <ul style="list-style-type: none"> • Replace grates.
Surface burner grates and caps	Warm, soapy water and a mildly abrasive plastic scrubbing pad and/or powdered cleanser	<ul style="list-style-type: none"> • Clean as soon as they become dirty and when they are cool enough to handle. • Wash with a mildly abrasive plastic scrubbing pad and warm, soapy water. • For stubborn stains, clean with a scrubbing pad and/or a powdered cleanser and water. Repeat these cleaning steps as needed.
Surface burners		See “Caring for your cooktop” earlier in this section for cleaning instructions.



Using and replacing the surface light (Models KGRT507 and YKGRT507)

The surface light is in the backguard. It is controlled by the Surface light pads on the control panel. The ON pad turns on the light immediately and keeps it on until you press OFF. The Night pad will turn on the surface light automatically when the light in the room is low enough to require a night light. When the night light comes on, it will also dim all lights appearing on the display. Press OFF to turn off the regular surface light or press NIGHT again to turn off the night light.

To turn on the surface light:

PRESS



To turn off surface light:

PRESS



To turn on night light:

PRESS



“NIGHT LIGHT” shows on the display when the night light is on.

To turn off night light:

PRESS again



Replacing the surface light:

1. Unplug range or disconnect power.

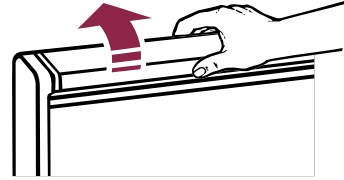

2. Flip up the top of the backguard.

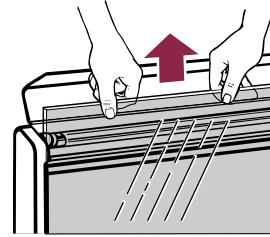

3. Pull up glass on front of backguard.

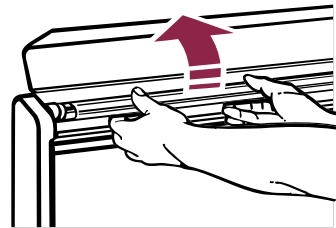

4. Grasp the fluorescent light tube at both ends. **Turn** the tube approximately 90° in either direction until both ends come out of the receptacles. **Replace** with a 20-watt cool-white fluorescent light tube.



- 5. If the surface light still does not work,** you may need to replace the starter. The starter is a knob-shaped part located on the right side of the backguard, under the light tube.

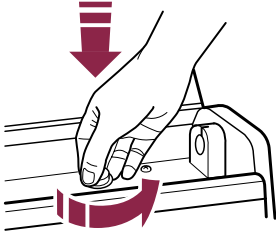

To remove and replace the starter, first remove light tube. Push starter in and **turn** approximately 90° counterclockwise. **Pull** starter out of recessed area. You can find replacement starters at stores that sell fluorescent light tubes.

- 6. Replace** glass and **close** the top panel.
- 7. Plug in** range or **reconnect** power.

Using and Caring for Your Oven

This section tells you, step by step, how to operate all oven functions controlled by the electronic control. Carefully follow these instructions, along with the cooking tips and cleaning information, for successful use of your range. Your model may not have all the features shown on the control display.

Using the electronic oven control

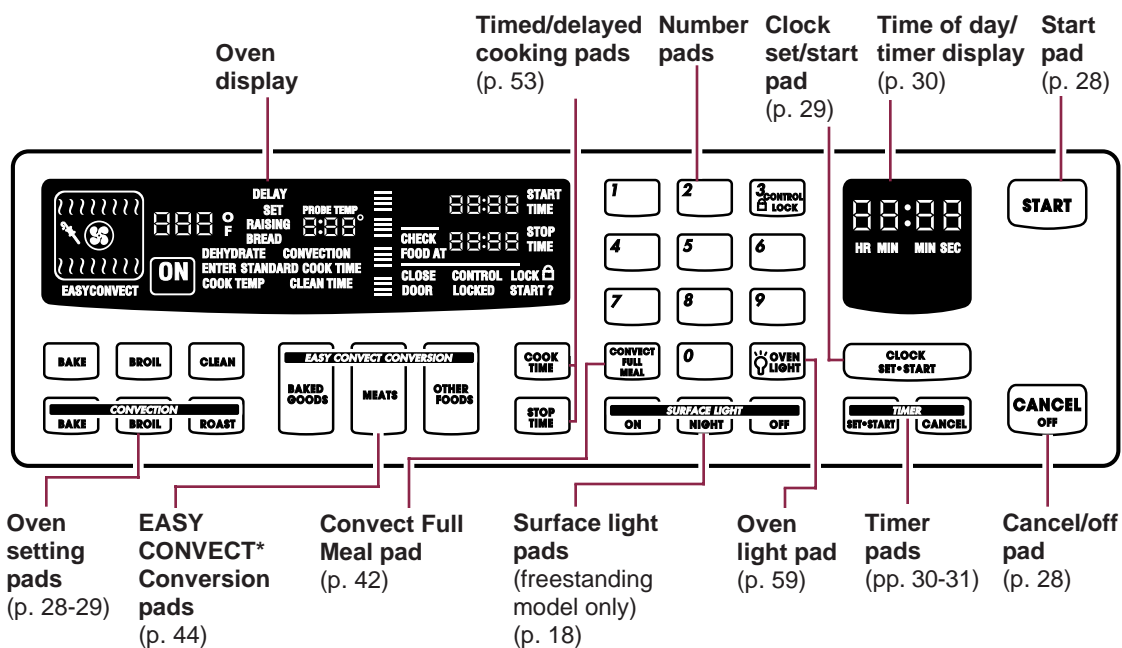

Display/clock

- **When you first plug in the range**, a tone will sound, the display will be fully lit for a few seconds, and the display will show the last time set and “PF” (power failure). If, after you set the clock (See “Setting the clock” later in this section), the display again shows “PF,” your electricity was off for a while. Reset the clock.
- **The time display will show “Err”** and 3 short tones will sound if a time or temperature is incorrectly entered.

NOTE: If you press a command pad several times, the pad can stop working. If you wait a few seconds, you can use the pad again. When you first use the pad again, you may have to hold down on the pad a short time to get it to work.



Fahrenheit/Celsius

To set your oven to cook in Celsius instead of Fahrenheit:

1. Open the door.

2. Press Cancel/Off pad.

PRESS



3. Press the Number Pads 1, 2, and 3, in that order.

PRESS

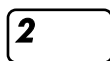

4. Press BROIL.

PRESS



5. Start oven.

NOTES:

- Press **BAKE** to confirm that you are using Celsius.
- **Only the temperature** and a flashing degree symbol will appear in the temperature display area when you set your oven to cook in Celsius.

PRESS



Repeat the steps above to change from Celsius to Fahrenheit.



Using and Caring for Your Oven

If you need to convert temperatures from Celsius to Fahrenheit or vice versa, you can refer to this chart:

Temperature replacement values

38°C=100°F	163°C=325°F
60°C=140°F	177°C=350°F
66°C=150°F	191°C=375°F
77°C=170°F	204°C=400°F
93°C=200°F	218°C=425°F
121°C=250°F	232°C=450°F
135°C=275°F	246°C=475°F
149°C=300°F	260°C=500°F

Disable/enable audible signals

Audible signals tell you if a function is entered correctly or not. They also tell you when a cycle is completed. To turn off key entry tone, end-of-cycle tone, and reminder tones, follow these steps:

1. Open the door.

2. Press Cancel/Off pad.

PRESS





3. Press the Number Pads 1, 2, and 3, in that order.

PRESS

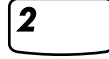

4. Press Timer Set/Start pad.

PRESS



5. Start oven.

“Snd” and “Off” will appear on the display.

PRESS



Repeat Steps 1-5 to turn the signals back on.

“Snd” and “On” will appear on the display.



Using and Caring for Your Oven

Using the control lock

The control lock prevents unwanted use of the oven by disabling the control panel command pads.

NOTES:

- **Control lock** is only available when oven is not in use or control has not been set.
- **Control lock** will not disable the Timer.
- **Set control lock** when cleaning the control panel to prevent oven from accidentally turning on.

To lock or deactivate the control panel:

1. Open the door.

2. Press and hold the Control Lock pad (Number Pad 3) for 5 seconds.

A single tone will sound and “START?” will appear on the display.

PRESS



YOU SEE



3. Press START.

PRESS



YOU SEE



To unlock the control panel:

1. Open the door.

2. Press and hold the Control Lock pad (Number Pad 3) for 5 seconds.

A single tone will sound and “CONTROL LOCK ” will disappear from the display.

PRESS





Using the Sabbath mode

What your oven will do while in the Sabbath mode:

- **The time display** will show “SAb” to tell you that the oven is in the Sabbath mode.
- **The ON Indicator Light** will light up when the burner turns on and ON will go off when the burner turns off.
- **To prevent accidental key presses**, the key pads will only work after you press them for 1 second.
- **No tones** will sound.

To enable the Sabbath mode:

1. Open the door.

2. Press Cancel/Off pad.

PRESS



3. Press the Number Pads 7, 8, and 9, in that order.

PRESS

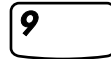

4. Press Number Pad 6.

PRESS



5. Press Start.

“SAb” and “On” will appear on the display.

PRESS



To disable the Sabbath mode:

Repeat the steps above to disable the Sabbath mode. “SAb” and “Off” will appear on the display.



Using and Caring for Your Oven

Setting your range for the Sabbath†

If you want to set your range to meet “no work” requirements for the Sabbath, first turn on the Sabbath mode (see “To enable the Sabbath mode” earlier in this section). Then follow these steps:

1. Turn the oven light and/or surface light (if available) on or off.

NOTE: See “Using and replacing the surface light” in the “Using and Caring for Your Cooktop” section and “Using and replacing the oven light(s)” in the “Using and Caring for Your Oven” section for more information.

These lights will stay turned on or off (whichever you set) while in the Sabbath mode. Opening the door will not turn on the oven light if it is programmed to be off.

2. Open the door.

3. Press BAKE.

PRESS



4. Press Number Pads to set the temperature you want.

Example for 325°F (163°C):

PRESS

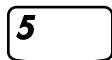

5. Start oven.

PRESS



† Star K certification pending. Full certification by Star K is expected by the end of 1997. Information is accurate as of 6/97.



6. Press and hold Number Pad 6 for 5 seconds.

“START?” appears on the display.

PRESS

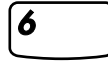

YOU SEE



7. Press START.

“SAb” appears on the display.

PRESS



YOU SEE



To end the Sabbath mode and turn off the oven:

1. Open the door.

2. Press and hold Number Pad 6 for 5 seconds.

PRESS





Using and Caring for Your Oven

Starting an operation

After programming a function, you must press the Start pad to start the function. If you do not press the Start pad within 5 seconds of programming, "START?" will show on the display as a reminder.



In case of a power failure

Your oven will not work during a power failure. Do not try to relight the oven. Wait for the power to come back on before using the oven again.

Canceling an operation

The Cancel/Off pad will cancel any function, except for the Clock Set/Start and Timer functions. When you press the Cancel/Off pad, the large display will show the time of day or, if Timer is also being used, the time remaining.



Oven settings

This chart tells you when to use each setting. It also explains what burners heat up for each setting.

SETTING	DIAGRAM	SETTING INFORMATION
BAKE Use this setting for baking and heating casseroles.		<ul style="list-style-type: none"> • The bake burner lights up. • During baking, the burner will turn on and off to maintain the oven temperature.
BROIL Use this setting for broiling regular-sized and smaller cuts of meat, poultry, and fish.		<ul style="list-style-type: none"> • The broil burner lights up. • During broiling, the burner will turn on and off to maintain the oven temperature.
CONVECTION BAKE Use this setting for foods which require gentle heating and for baking breads and cakes. Use also when baking large quantities of food on more than one oven rack.		<ul style="list-style-type: none"> • The bake burner lights up. • One minute after the setting starts, the fan at the back of the oven will go on. • The fan circulates air in the oven cavity for even heating.



SETTING	DIAGRAM	SETTING INFORMATION
<p>CONVECTION BROIL Use this setting for broiling thick cuts of meat.</p>		<ul style="list-style-type: none"> • The broil burner lights up. • During broiling, the burner will turn on and off to maintain the oven temperature. • One minute after the setting starts, the fan at the back of the oven will go on. • The fan will cycle on for 10 seconds and off for 20 seconds.
<p>CONVECTION ROAST Use this setting for roasting and baking on one rack.</p>		<ul style="list-style-type: none"> • The bake burner lights up. • One minute after the setting starts, the fan at the back of the oven will go on. • The fan circulates air in the oven cavity for even heating.
<p>CLEAN Use this setting for self-cleaning only.</p>		<ul style="list-style-type: none"> • The broil burner cycles for the first 30 minutes. • After 30 minutes, the bake burner cycles at the clean temperature.

Setting the clock

NOTE: If an oven function is active or programmed, you cannot change the clock.

1. Press Clock Set/Start pad.

PRESS



YOU SEE



2. Set time.

PRESS



YOU SEE



continued on next page



Using and Caring for Your Oven

3. Start clock.

If time has not been entered correctly, three short tones will sound and "Err" will be displayed. The display will show the closest valid time. Repeat Steps 2 and 3 to re-enter the time of day.

NOTE: You can clear the time of day from the display by opening the door then pressing and holding CLOCK SET/ START for 5 seconds. Repeat to see time of day on display again.

PRESS



YOU SEE



Using the timer

The Timer does not start or stop the oven. It works like a regular kitchen timer. It can be set in hours and minutes up to 99 hours, 59 minutes or in minutes and seconds up to 99 minutes, 59 seconds.

1. Press Timer Set/Start pad.

- **Once** to set hours and minutes
- **Twice** to set minutes and seconds

PRESS



YOU SEE



(example shows hours and minutes timer setting 1)

2. Set time.

PRESS

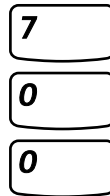

YOU SEE



(example shows a 7-hour timer setting)

3. Start Timer.

The Timer will begin counting down immediately after you press the Timer Set/Start pad or Start pad.

PRESS



YOU SEE

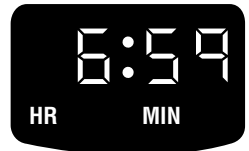



4. When time is up, turn off Timer.

When time is up, you will hear four tones (unless the audible signals have been disabled). Press the Timer Cancel pad to clear the display.

YOU SEE

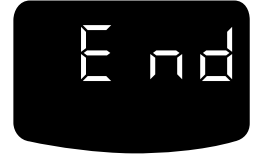

To change the timer during its operation:

1. Press Timer Set/Start pad.
2. Enter new desired time.
3. Press Timer Set/Start pad.

To cancel the timer during its operation:

You can cancel the Timer any time during its operation. Press the Timer Cancel pad.

PRESS



Baking or convection baking

NOTE: Do not attempt to light the oven burner during a power failure. See “Range Safety” for more information.

1. Position racks.

For correct rack placement, see “Rack positions” and “Rack placement” chart later in this section.

NOTES:

- Before turning oven on position oven rack(s) in desired location.
- Be sure the rack(s) is level.
- Use pot holders or oven mitts to protect hands if rack(s) must be moved while oven is hot.
- Do not let pot holder or oven mitt touch oven bottom.
- See “Cooking tips” later in this section for additional cooking tips.

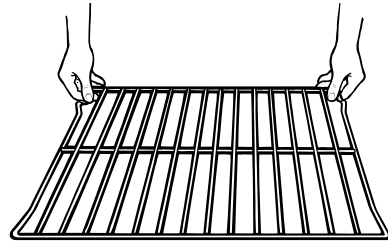

continued on next page



Using and Caring for Your Oven

2. Choose baking setting.

PRESS



OR

PRESS



YOU SEE

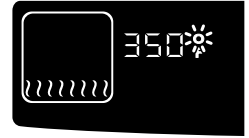

(or 177°C)

YOU SEE

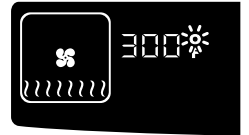

(or 149°C)

3. Set temperature (optional).

Do this step if you want to set a temperature other than 350°F (177°C) for Bake or 300°F (149°C) for Convection Bake.

NOTE: See a reliable cookbook or your convection oven cookbook for temperature recommendations.

PRESS



YOU SEE



(example for Bake at 375°F [191°C])

4. Preheat oven.

After the temperature reaches 170°F (77°C), the temperature display will show the actual oven temperature at each 5°F (3°C) increase and stop at the set temperature. One long tone will sound when oven is preheated.

NOTE: For convection cooking, the fan will be delayed for 1 minute to provide good ignition. The fan may cycle on and off during convection cooking.

PRESS



YOU SEE

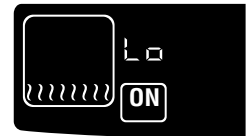

(example for Bake) ("Lo" is displayed after 5 seconds if oven temperature is below 170°F [77°C])

5. Put food in oven.

NOTE: If you want to change the baking temperature after baking has begun, repeat Steps 2, 3, and 4.

6. After cooking, turn off oven.

PRESS



YOU SEE

(display will go blank)



Roasting

NOTE: Do not attempt to light the oven burner during a power failure. See “Range Safety” for more information.

1. Prepare oven.

Position the rack properly. For correct rack placement, see “Rack positions” later in this section. Place food in the oven. For large roasts and turkeys, place rack in position 1 or 2.

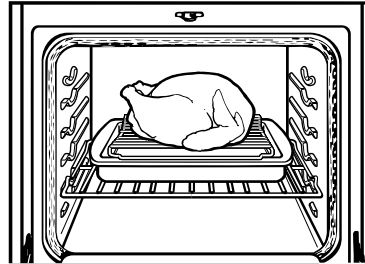

2. Choose setting.

PRESS



YOU SEE

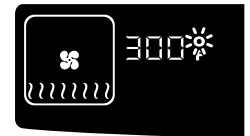

(or 149°C)

3. Set temperature (optional).

Do this step if you want to set a temperature other than 300°F (149°C).

NOTE: See your convection oven cookbook for temperature recommendations.

PRESS

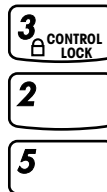

YOU SEE



(example shows 325°F [163°C] temperature setting)

continued on next page



Using and Caring for Your Oven

4. Start oven.

NOTES:

- **After the temperature** reaches 170°F (77°C), the temperature display will show the actual oven temperature at each 5°F (3°C) increase and stop at the set temperature. One long tone will sound when oven is preheated.
- **If you want** to change the roasting temperature after roasting has begun, repeat Steps 2, 3, and 4.
- **The fan** will be delayed for 1 minute to provide good ignition.
- **The fan** may cycle on and off during convection roasting.

PRESS



YOU SEE

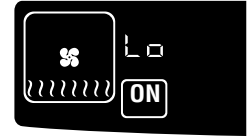

("Lo" is displayed after 5 seconds if oven temperature is below 170°F [77°C])

5. After cooking, turn off oven.

PRESS



YOU SEE

(display will go blank)

Cooking tips

Baking/convection baking tips

The hot air must circulate around the pans in the oven for even heat to reach all parts of the oven. This results in better baking.

For best air circulation:

- **Place** the pans so that one is not directly over the other.



- **For best results**, allow 1 1/2 to 2 inches (3 to 5 cm) of space around each pan and between pans and oven walls.
- **When baking with one pan**, place pan in the center of the oven rack.

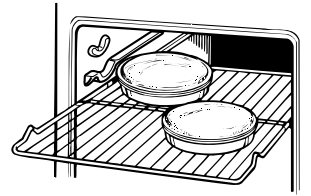

- **When baking with two pans**, place pans in opposite corners of the oven rack.

NOTES:

- **"Oven peeking"** may cause heat loss, longer cooking times, and unsatisfactory baking or roasting results. Rely on your timer.
- **Do not allow pans** to touch the heat sensor on the left wall near the back. Poor baking may result.
- **Do not use** aluminum foil when baking. Aluminum foil may block airflow.



Rack positions

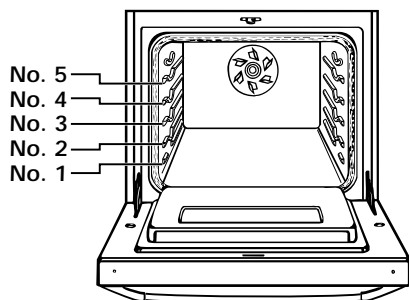

Your oven has three straight racks and five rack positions. Rack position 5 is the highest position, or farthest from the bottom of the oven. Rack position 1 is the lowest position, or closest to the bottom of the oven.

Baking tips

(Bake pad)

For proper cooking, follow these guidelines:

- **When using one rack**, place the rack so the top of the food will be centered in the oven.
- **When using more than one rack**, use the Convection Bake setting.
- **Use only one** cookie sheet in the oven at a time when using the Bake setting.

Bakeware tips

- **When baking with insulated cookie sheets or baking pans**, place them in the bottom third of the oven. You may need to increase the recommended baking times, so test for doneness before removing from the oven.
- **When using ovenproof glassware or dark bakeware**, reduce the oven temperature by 25°F (16°C), but use the same baking time. Because these pans absorb heat, producing darker bottom browning and crispier crusts, place the rack in the center of the oven. When baking pies and bread, you can use the temperature suggested in the recipe.

Rack placement for specific foods:

(For rack positions, see “Rack positions” in previous column.)

FOOD	RACK POSITION
Frozen pies	2
Angel food and bundt cakes, most quick breads, yeast breads, casseroles, meats	1 or 2
Cookies, biscuits, muffins, cakes, nonfrozen pies	2 or 3

NOTE: For additional baking tips see “Baking or convection baking” earlier in this section.

Convection baking tips

(Convection Bake pad)

- **Do not use** aluminum foil when convection baking. Aluminum foil may block airflow.
- **Reduce** recommended standard cooking temperatures by approximately 25°F (16°C). The cooking times can also be reduced for most recipes. See recipes and cooking charts in your convection oven cookbook for recommended temperatures and times, or use EASY CONVECT* Conversion (later in this section).
- **NOTE:** Cooking time may be longer when you use more than one rack.
- **When baking on two or three racks**, use the Convection Bake setting for more even results. (You can, however, use only one rack when Convection Baking.)

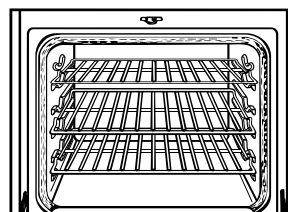

- **To use three racks during convection baking**, place one rack in position 5 (the highest position), another rack in position 1 (the closest to the oven bottom), and the third rack in position 3. This allows all three racks to be an equal distance apart for better baking.
- **Stagger** cake pans or other cookware in opposite directions on each rack when three racks are used.



Using and Caring for Your Oven

Roasting tips

- **Spatter can be reduced** by lining the bottom of the roasting pan with lightly crushed aluminum foil.
- **Use an accurate meat thermometer or temperature probe** (see “Using the temperature probe” later in this section) to determine when meat has reached desired degree of doneness. Insert the thermometer or probe into the center of the thickest portion of the meat or inner thigh or breast of poultry. For an accurate reading, the tip of the thermometer or probe should not touch fat, bone, or gristle.
- **After reading the thermometer once,** push it further into the meat $\frac{1}{2}$ inch (1 cm) or more and read again. If the temperature drops, return the meat to the oven for more cooking.
- **Check pork and poultry** with a thermometer in 2-3 places to ensure adequate doneness.
- **Poultry and roasts will be easier to carve** if loosely covered with foil and allowed to stand 10-15 minutes after removal from the oven.
- **You can reduce** roasting times and temperatures for most standard recipes when using the Convection Roast setting. See recipe adaption chart or convection-roasting chart in your convection oven cookbook for recommended roasting times and temperatures, or use EASY CONVECT* Conversion (later in this section).

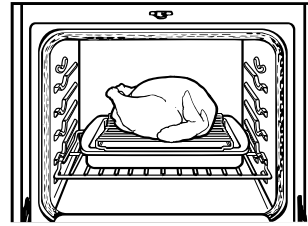

- **Use the convection roasting rack** on the broiler pan (both included with your range). (The convection roasting rack rests on the broiler pan, not inside it.) The long side of the rack should be parallel with the oven door for best heat distribution and airflow.



Adjusting oven temperature

Although your new oven is properly adjusted to provide accurate temperatures, it may cook faster or slower than your old oven.

If, after using the oven for a period of time, you are not satisfied with the baking/roasting results, you can change the offset temperature by following the steps below. The control will “remember” the selected offset even after the power has been interrupted or lost. To change the offset temperature:

NOTE: DO NOT measure oven temperature with a thermometer. Opening the oven door will lower the oven temperature and give you an inaccurate reading. Also, the thermometer temperature reading will change as your oven cycles.

1. Open the door.

2. Press Cancel/Off pad.

PRESS



3. Press the Number Pads 1, 2, and 3, in that order.

PRESS

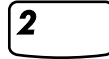

4. Press BAKE.

PRESS



continued on next page



Using and Caring for Your Oven

5. Start oven.

The display shows 0°F (-18°C) and “COOK TEMP.”

PRESS



YOU SEE



(or -18°C)

6. Set the new offset temperature.

Press BAKE to increase the setting.
Press BROIL to decrease the setting.

PRESS



YOU SEE



(example when making oven 10°F [or 6°C] hotter)

7. Press START to enter the adjustment.

NOTE: The offset temperature will remain the same if you press the Cancel/Off pad.

PRESS



How to determine the amount of adjustment needed

The following chart tells you how much to adjust the offset temperature to get the desired cooking results. You can determine cooking results by amount of browning, moistness, and rising times for baked foods.

TO COOK FOOD ...	ADJUST BY THIS NUMBER OF DEGREES
A little more	+5°F to +10°F (+3°C to +6°C)
Moderately more	+15°F to +20°F (+8°C to +12°C)
Much more	+25°F to +35°F (+16°C to +21°C)
A little less	-5°F to -10°F (-3°C to -6°C)
Moderately less	-15°F to -20°F (-8°C to -12°C)
Much less	-25°F to -35°F (-16°C to -21°C)



Using the temperature probe

The Temperature Probe is the most accurate guide to the degree of doneness of meat. Use it when baking, roasting any type of meat or poultry, or cooking casseroles with liquid.

NOTES:

- **Do not use** the Temperature Probe when broiling, convection broiling, dehydrating, or raising bread.
- **Unplug** the Temperature Probe before self-cleaning the oven.

1. Insert probe into food.

Insert the probe into the center of the thickest portion of meat or into the inner thigh or breast of poultry, away from fat or bone.

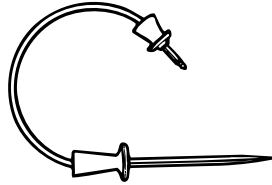

2. Put food in oven.

Place meat on the convection roasting rack, place rack on broiler pan, and place pan in the center of the oven.



3. Connect probe to oven.

Open the Temperature Probe cover located on the left side of the oven wall. Insert plug into jack. (Keep the top of the probe as far as possible from the heat source.)



YOU SEE

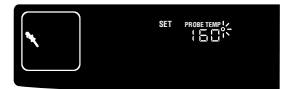

(or 71°C)

4. Close oven door.

continued on next page



Using and Caring for Your Oven

5. Set temperature (optional).

Do this step if you want to set an internal food temperature (from 130°F [54°C] to 190°F [88°C]) other than 160°F (71°C).

NOTE: See a reliable cookbook or your convection oven cookbook for internal food temperature recommendations.

PRESS



YOU SEE



(example shows 150°F [66°C] internal temperature setting)

6. Choose cook setting.

- BAKE,
- CONVECTION BAKE, or
- CONVECTION ROAST

PRESS

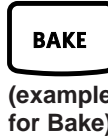

(example for Bake)

YOU SEE



(or 177°C)

7. Set temperature (optional).

Do this step if you want to set an oven temperature other than the one displayed.

NOTE: See a reliable cookbook or your convection oven cookbook for oven temperature recommendations.

PRESS

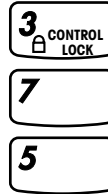

YOU SEE



(example shows 375°F [191°C] temperature setting)

8. Start oven.

NOTES:

- **If you do not choose** a cook setting and press START, the display will show a bake setting at 350°F (177°C). If you want to bake at 350°F (177°C), press START to begin. If you want to cook with another setting or at another temperature, do Steps 6 and 7 above and press START.
- **The temperature display** will show the set oven temperature throughout temperature probe cooking.
- **After the food temperature** reaches 130°F (54°C), the probe display will show the actual food temperature at each 5°F (3°C) increase and stop at the set temperature. Four tones will sound and “End” will show when food reaches the set temperature (unless the audible signals have been disabled). The oven then shuts off.

PRESS



YOU SEE

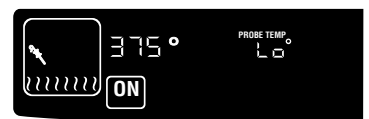

(example for Bake)



- **If you want to change** the probe temperature after cooking has begun, repeat Steps 6, 5, and 8, in that order. At Step 6, you will be prompted for a new probe temperature. You may also change the oven temperature at this point by pressing the Bake pad again.

⚠️ WARNING

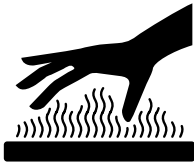

Burn Hazard

Use an oven mitt to remove temperature probe.

Do not touch broil element.

Failure to follow these instructions can result in burns.

9. After cooking, unplug probe.

The probe symbol will remain lit until you unplug the Temperature Probe.

10. Remove food from oven.

(This prevents overcooking.)

11. Clean probe.

Wash with a soapy sponge and dry thoroughly. Use a plastic scouring pad to remove cooked-on foods. You can also clean the probe in a dishwasher.



Using CONVECT FULL MEAL

Convect Full Meal lets you choose from among 10 preset oven convection cooking cycles, all using the convection fan. These cycles store commonly used cooking times, cooking temperatures, and probe temperature settings. Convect Full Meal saves you time by limiting the number of pads you have to press when cooking a favorite food. Convect Full Meal also lets you set your own favorite cycle (either convection or nonconvection).

1. Place food in cold oven.

If you need the Temperature Probe for your cycle (cycles 5-8 in the “Convect full meal chart” later in this section), insert probe into food. (Follow Steps 1-4 in “Using the temperature probe” earlier in this section.)

2. Press Convect Full Meal pad.

PRESS



YOU SEE



(“C” stands for “cycle,”
“F” stands for “favorite”)

3. Press desired Number pad.

Use the “Convect full meal chart” later in this section as your guide for selecting a cycle.

NOTES:

- **You can change** the Convect Full Meal cycle any time before pressing the Start pad by repeating Step 3.
- **You can program your own cycle**, which you can then select in the future by pressing just CONVECT FULL MEAL and START. (See “To program your own cycle” later in this section for more information.)

PRESS



YOU SEE

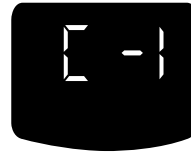

(example for cycle 1)

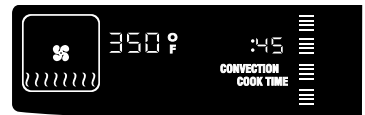

(or 177°C)

4. Start oven.

PRESS



YOU SEE





5. When the Convect Full Meal cycle is done:

Four tones will sound, followed by four reminder tones every minute (if the audible signals have not been disabled), until you open the door, remove the probe, or press the Cancel/Off pad.

YOU SEE



Convect full meal chart

CYCLE NUMBER	CONVECTION CYCLE	OVEN TEMP	TIME OR PROBE TEMP	FOOD OR MEAL
1	Conv. Bake	350°F (177°C)	45 min	Meal # 1: Chicken pieces, Fruit crisp, Vegetable casserole
2	Conv. Bake	350°F (177°C)	1 hr	Meal # 2: Macaroni and cheese, Baked winter squash, Fruit pie
3	Conv. Bake	350°F (177°C)	1 hr 15 min	Meal # 3: Pre-cooked ham, Baked potatoes, Quick bread loaf OR Baked potatoes only
4	Conv. Bake	375°F (191°C)	55 min	Meal # 4: Beef stew, Scalloped potatoes, Frozen fruit pie
5	Conv. Roast	300°F (149°C)	140°F (60°C)	Beef roast rare
6	Conv. Roast	300°F (149°C)	160°F (71°C)	Beef roast medium
7	Conv. Roast	300°F (149°C)	170°F (77°C)	Beef roast well Pork roast Meat loaf
8	Conv. Bake	325°F (163°C)	160°F (71°C)	Casseroles
9	Conv. Bake	325°F (163°C)	3 hr	Pot roast with vegetables – 3 lbs (1 kg)
0	Conv. Roast	400°F (204°C)	18 min	Pizza

To program your own cycle:

1. Press CONVECT FULL MEAL.
2. Press the Command Pad for the cook setting you want (for example, BAKE).
3. Enter the temperature and cook time you want. (The default is Bake at 170°F [75°C] for 2 hours.) Entering a cook time of 0 minutes lets you do untimed cooking.

4. To save only, press CONVECT FULL MEAL.

To cook with this cycle immediately and save it, press START.



Using and Caring for Your Oven

When programming your own cycle:

- 1. Start** with meat or main dish items (times are more critical with these items).
- 2. Choose** baked goods with bake temperatures similar to those of meat or main dish items. Convection baking time of +/-10 to 15 minutes and temperatures of +/-25°F to 50°F (+-4°C to +-10°C) are acceptable.
- 3. Choose** vegetables and fruits last.

Using EASY CONVECT* Conversion

EASY CONVECT Conversion lets you convection cook without entering convection cook temperatures and times. Simply enter the standard cook temperature and time for the food to be cooked. The oven will reduce the temperature, or the temperature and time, for convection cooking. (Convection temperatures and times are not as long because the heated air is circulated in the oven cavity for quicker cooking.)

NOTE: The converted temperatures and times are not precise because the food categories you choose from are general. (See “EASY CONVECT Conversion setting chart” later in this section for which foods you can cook in each category.) To ensure proper cooking, the oven will prompt you to check food at the end of cook time. If food needs more cooking, the oven will continue to cook. If food does not need more cooking, press CANCEL/OFF.

⚠ WARNING

Food Poisoning Hazard

Do not let food sit in oven more than one hour before or after cooking.

Doing so can result in death, food poisoning, or sickness.

1. Place food in oven.

2. Press one of three Easy Convection Conversion Pads.

Example for Meats:

PRESS



YOU SEE



3. Enter standard cook temperature.

PRESS



YOU SEE



(example showing 325°F [163°C] – cooking without temperature probe)



4. Enter standard cook time.

NOTES:

- **This step** is not needed when using the temperature probe.
- **To delay convection cooking**, after Step 4, press the Stop Time pad and enter the desired stop time. Cooking will start at the time equal to the stop time less the cook time. (Example: A cook time of 1 hour and a stop time of 4:00 would give you a start time of 3:00.)

PRESS

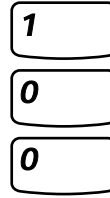

YOU SEE



(example showing 1 hour)

5. Start oven.

NOTE: The actual temperature reduction and time savings are different for each food category and oven type.

PRESS



YOU SEE



(display shows temperature reduced by 25°F [16°C] – nondelayed cooking)

6. At end of cook time (nondelayed cooking):

YOU SEE

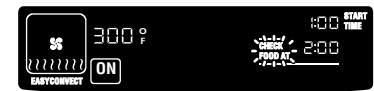

7. Open door and check food (nondelayed cooking).

If you want to continue cooking, close door and the oven will continue cooking.

If you do not want to continue cooking, press the Cancel/Off pad.

YOU SEE

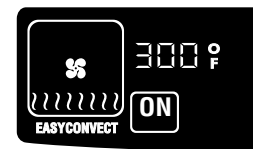

8. When stop time is reached (delayed cooking only):

Four tones will sound, followed by four reminder tones every minute (unless the audible signals have been disabled), until you open the door, remove the probe, or press the Cancel/Off pad.

YOU SEE





EASY CONVECT* Conversion setting chart

EASY CONVECT SETTING	FOODS YOU CAN COOK WITH THIS SETTING
Baked Goods	Cakes, cookies, muffins, quick breads, biscuits, yeast bread
Meats	Roasts, ham, whole chicken, chicken pieces, chops, meat loaf NOTE: Turkey or large poultry are not included because their cooking times vary.
Other Foods	Egg and cheese dishes, fish, casseroles, frozen convenience foods, potatoes, squash, meat pies, fruit pies

Broiling

1. Position rack and close door.

See “Thermal broiling chart” later in this section for recommended rack positions.

NOTES:

- **Before turning oven on** position oven rack(s) in desired location.
- **Be sure** the rack(s) is level.
- **Use pot holders or oven mitts to protect hands** if rack(s) must be moved while oven is hot.
- **Do not let** pot holder or oven mitt touch hot broil burner.
- **See “Broiling tips”** later in this section for additional broiling tips.

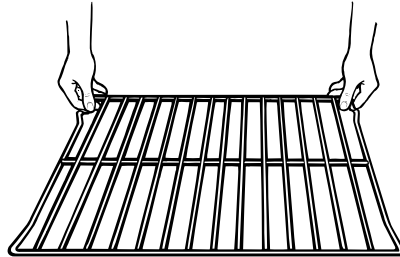

2. Preheat broiler for 5 minutes before using.

3. Press Broil pad.

PRESS



YOU SEE

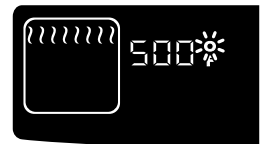

(or 260°C)



4. Set temperature (optional).

Do this step if you want to use a broiling temperature other than 500°F (260°C) (see “Variable temperature broiling” later in this section).

NOTE: See “Thermal broiling chart” later in this section for temperature recommendations.

PRESS

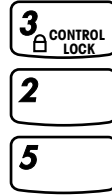

YOU SEE

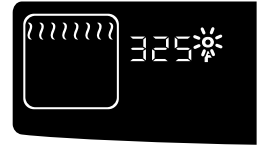

(example shows 325°F [163°C] broiling temperature)

5. Start oven.

NOTE: If you want to change the broiling temperature after broiling has begun, repeat Steps 3, 4, and 5.

PRESS



YOU SEE

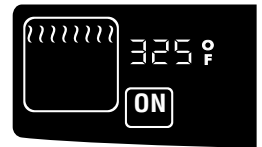

6. After preheating, put food in oven.

Place food on grid in broiler pan and place in center of the oven rack.

NOTES:

- **Place food** about 3 inches (7.5 cm) or more from the broil burner.
- **To ensure adequate grease drainage**, do not use cookie sheets or similar pans for broiling.
- **If foil is used** to cover broiler grid, cut slits in foil to allow grease to drain away.



Broiler grid



Broiler pan

7. Completely close door.

NOTE: Do not try to broil with the door open. The broil burner will not operate.

8. When broiling is done, turn off oven.

PRESS



YOU SEE

(display will go blank)

Variable temperature broiling

- **If food is cooking too fast** or you want the food to broil slower from the start, set the broil temperature between 170°F (77°C) and 325°F (163°C). These temperature settings allow the broil burner to cycle and to slow cooking. The lower the temperature, the slower the cooking.
- **Fish and chicken** are some foods that may cook better if you use lower broiling temperatures.



Convection broiling

Convection broiling is actually high-temperature convection roasting. Use this setting when broiling thick cuts of meat. Results are similar to those you get when using a rotisserie.

1. Position rack.

See “Thermal broiling chart” later in this section for recommended rack positions.

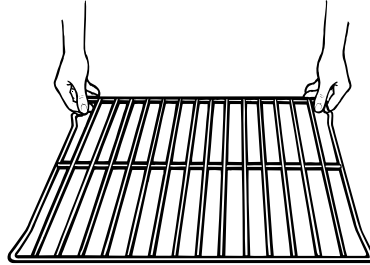

2. Preheat broiler for 5 minutes before using.

3. Press Convection Broil pad.

PRESS



YOU SEE

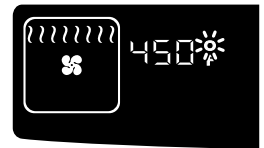

(or 235°C)

4. Set temperature (optional).

Do this step if you want to set a temperature (up to 500°F [260°C]) other than 450°F (232°C).

NOTE: See your convection oven cookbook for temperature recommendations.

PRESS

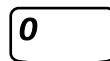
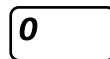
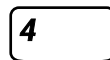

YOU SEE

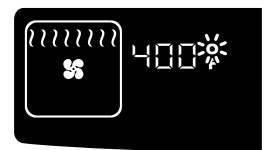

(example shows 400°F [204°C] temperature setting)

5. Start oven.

NOTES:

- If you want to change the convection broiling temperature after broiling has begun, repeat Steps 3, 4, and 5.
- The fan will be delayed for 1 minute to provide good ignition.
- The fan will cycle on and off during convection broil.

PRESS



YOU SEE





6. After preheating, put food in oven.

Place food on grid in broiler pan and place in center of the oven rack. Turn the pan so the long side is parallel to the oven door for the most even heat and the best airflow.

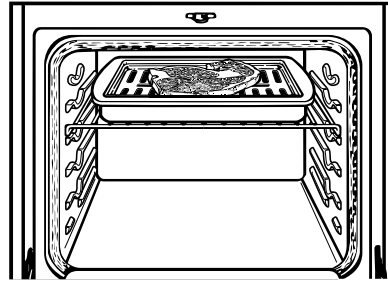

7. Close door.

NOTE: Do not try to convection broil with the door open. The fan and broil burner will not operate.

8. When broiling is over, turn off oven.

PRESS



YOU SEE

(display will go blank)

Broiling tips

- **Use the broiler pan and grid for broiling.** They are designed to drain excess liquid and grease away from the cooking surface to help prevent spatter or smoke.
 - **If you broil small quantities,** you may want to use a small broiler pan. They are available in the housewares section of many department stores.
 - **For best broiling results,** preheat for 5 minutes. Do not preheat with broiler pan in place.
 - **Broiling rack position** determines how the burner cooks your food. The lower the position, the more broiler grid area covered. See “Thermal broiling chart” later in this section for more information.
 - **To sear meat,** place broiler pan at one of the higher rack positions.
 - **Thin (¾" [2 cm]) steaks** may be broiled in the higher rack positions.
 - **To cook thick (1½" [4 cm]) steaks** and other thick cuts of meat well done, start cooking on a lower rack position or move them to a lower rack position after searing.
 - **After broiling,** remove the broiler pan from the oven when you remove the food. Drippings will bake on the pan if you leave it in the heated oven.
- NOTE:** See “Broiling” earlier in this section for additional broiling tips.



Using and Caring for Your Oven

Thermal broiling chart:

The recommended rack position is numbered lowest (1) to highest (5). Preheat broiler for 5 minutes before placing food in oven.

MEAT	RACK POSITION	TEMPERATURE	APPROXIMATE TIME (MINUTES)	
			SIDE 1	SIDE 2
Steak, 1" (3 cm) thick • rare • medium • well-done	4	500°F (260°C)	4 6 8	4 6 8
Steak, 1½" (4 cm) thick • rare • medium	4	500°F (260°C)	8 10	8 10
Hamburger patties or steaks, ½" (12 mm) thick or less • medium	4	500°F (260°C)	6	4
Lamb chops, 1" (3 cm) thick	4	400°F (204°C)	9	9
Ham slice, ½" (12 mm) thick	4	500°F (260°C)	5	5
precooked 1" (3 cm) thick	4	500°F (260°C)	10	10
Pork chops, 1" (3 cm) thick	4	450°F (232°C)	12	12
Frankfurters	4	500°F (260°C)	4	4
Chicken pieces	3	500°F (260°C)	16	16
Fish, 1" (3 cm) thick	3	350°F (177°C)	10	10
Beef liver, ½" (12 mm) thick	4	350°F (177°C)	5	5

Temperatures and times are guidelines only and may need to be adjusted to individual tastes.



Timed cooking

The electronic clock/oven control will turn the oven on and off at times you set, even when you are not around.

Delayed time baking/roasting is ideal for foods which do not require a preheated oven, such as meats and casseroles. **Do not use delayed time cooking for cakes, cookies, etc. – they will not rise properly. Before using timed cooking, make sure the clock is set to the correct time of day.** (See the “Setting the clock” section.)

To start baking/roasting now and stop automatically:

1. Prepare oven.

Position the oven rack(s) properly and place the food in the oven. For correct rack placement, see “Rack positions” and “Rack placement” chart earlier in this section.

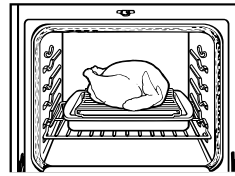

! WARNING

Food Poisoning Hazard

Do not let food sit in oven more than one hour before or after cooking.

Doing so can result in death, food poisoning, or sickness.

2. Choose cook setting.

- BAKE,
- CONVECTION BAKE, or
- CONVECTION ROAST

PRESS



YOU SEE

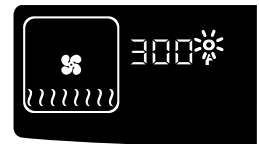

(or 149°)
(example for Convection Roast)

3. Set temperature (optional).

Do this step if you want to set a temperature other than the one displayed.

NOTE: See a reliable cookbook or your convection oven cookbook for temperature recommendations.

PRESS

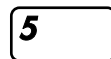
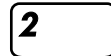

YOU SEE



(example shows 325°F [163°C] temperature setting in Convection Roast)

continued on next page



Using and Caring for Your Oven

4. Press Cook Time pad.

PRESS



YOU SEE



(start time display will light up, showing time of day)

5. Set cook time.

PRESS

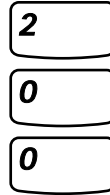

YOU SEE



(example shows 2-hour cook time with stop time now 2 hours later than time of day)

6. Start oven.

Vertical bar on display will get shorter as cook time counts down.

PRESS



YOU SEE



(cook time is displayed)

7. When baking/roasting is done:

“End” will show on the display. Four tones will sound, followed by four short reminder tones every minute (unless the audible signals have been disabled), until you open the door or press the Cancel/Off pad.

YOU SEE



To delay start and stop automatically:

1. Prepare oven.

Position the oven rack(s) properly and place the food in the oven. For correct rack placement, see “Rack positions” and “Rack placement” chart earlier in this section.

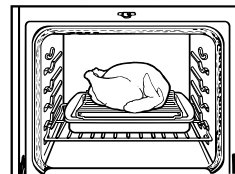

2. Choose cook setting.

- BAKE,
- CONVECTION BAKE, or
- CONVECTION ROAST

PRESS



YOU SEE

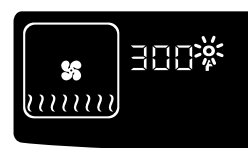

(or 149°C)
(example for Convection Roast)



3. Set temperature (optional).

Do this step if you want to set a temperature other than the one displayed.

NOTE: See a reliable cookbook or your convection oven cookbook for temperature recommendations.

PRESS

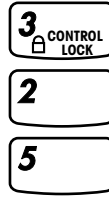

YOU SEE

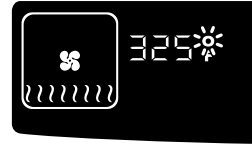

(example shows 325°F [163°C] temperature setting in Convection Roast)

4. Press Cook Time pad.

PRESS



YOU SEE



(start time display will light up, showing time of day)

5. Set cook time.

PRESS

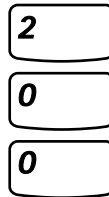

YOU SEE



(example shows 2-hour cook time with stop time now 2 hours later than time of day)

6. Press Stop Time pad.

PRESS



YOU SEE



7. Set stop time.

PRESS

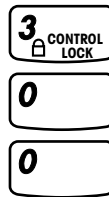

YOU SEE



(stop time display shows 3:00 and start time display shows 1:00 – stop time minus 2-hour cook time)

continued on next page



Using and Caring for Your Oven

8. Press Start pad.

PRESS



YOU SEE



When start time is reached:

Vertical bar on display will get shorter as cook time counts down.

YOU SEE



9. When baking/roasting is done:

“End” will show on the display. Four tones will sound, followed by four short reminder tones every minute (unless the audible signals have been disabled), until you open the door or press the Cancel/Off pad.

YOU SEE



To cancel timed cooking settings:

Press Cancel/Off pad.

PRESS



YOU SEE

(display will go blank)

Dehydrating

You can use your THERMAL-CONVECTION* oven to dehydrate a variety of foods.

NOTES:

- If you do not turn off oven after dehydrating, the oven will keep running until you press the Cancel/Off pad.
- To learn detailed information about dehydration, refer to a book written specifically about dehydrating and/or preserving foods.

1. Prepare food.

Prepare foods as recommended in recipe.

2. Arrange food on drying racks†.

† Racks are not included with the oven. Contact a local store handling specialty cookware. A dehydration kit which includes racks and a spacer (Part No. 4395974) can be ordered from your local

KitchenAid dealer, or by calling **1-800-422-1230** and following the instructions and telephone prompts you hear.



3. Place drying racks in the oven to allow maximum air circulation around the racks.

NUMBER OF RACKS	USE OVEN RACK POSITION
1 rack	3
2 racks	2 and 4
3 racks	1, 3, and 5

4. Position door.

Attach the dehydration spacer†, which is specially designed to depress the oven light plunger and maintain the operation of the fan during dehydration.

The spacer provides a 1-inch (3 cm) gap between the oven frame and the oven door allowing moisture to escape.

† The dehydration spacer (Part No. 814166) can be ordered from your local KitchenAid dealer, or by calling **1-800-422-1230** and following the instructions and telephone prompts you hear.

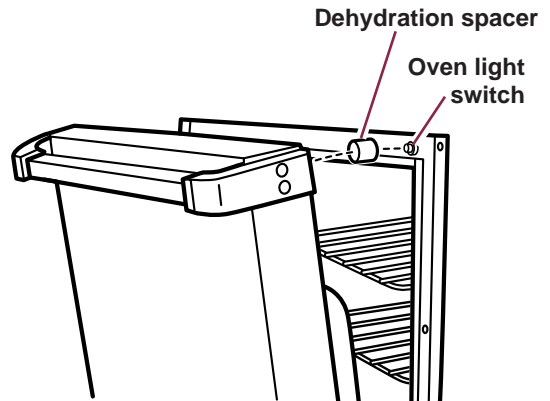

5. Open the door, then press and hold Convection Bake pad for 5 seconds.

PRESS



Hold for 5 seconds

YOU SEE

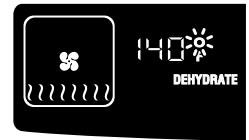

(or 60°C)

6. Set temperature (optional).

Do this step if you want to set a temperature (from 100°F [38°C] to 200°F [93°C]) other than 140°F (60°C).

NOTE: The 100°F setting will cause “RAISING BREAD” to be displayed. (See “Raising (proofing) bread” later in this section.)

PRESS

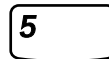
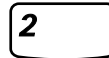
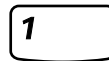

YOU SEE



(example shows 125°F [52°C] dehydrating temperature)

continued on next page



Using and Caring for Your Oven

7. Start oven.

NOTES:

- If you want to change the dehydrating temperature after dehydrating has begun, repeat Steps 5, 6, and 7.
- The fan will be delayed for 1 minute to provide good ignition.

PRESS



YOU SEE

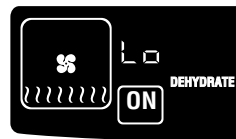

8. When dehydrating is done, turn off oven.

PRESS



YOU SEE

(display will go blank)

Raising (proofing) bread

You can use your THERMAL-CONVECTION* oven to raise (proof) bread. For more information, see the convection oven cookbook provided with your range.

NOTE: If you do not turn off oven after proofing bread, the oven will keep running until you press the Cancel/Off pad.

1. Put dough in oven.

NOTE: Be sure to close the door.

2. Open the door, then press and hold Baked Goods pad for 5 seconds.

NOTE: If you enter a different temperature, you will enter the Dehydrating mode.

PRESS



Hold for 5 seconds

YOU SEE



(or 38°C)

3. Start oven.

One long tone will sound when oven is preheated.

PRESS



YOU SEE



4. When proofing is done, turn off oven.

PRESS



YOU SEE

(display will go blank)



Cleaning your oven and controls

	⚠ WARNING
	<p>Explosion Hazard</p> <p>Do not store flammable materials such as gasoline near this appliance.</p> <p>Doing so can result in death, explosion, or fire.</p>

PART	WHAT TO USE	HOW TO CLEAN
Control knobs	Sponge and warm, soapy water	<ul style="list-style-type: none"> • Turn knobs to OFF and pull straight away from control panel. • Wash, rinse, and dry thoroughly. Do not soak. • Do not use steel wool or abrasive cleansers. They may damage the finish of the knobs. • Replace knobs. Make sure all knobs point to OFF.
Control panel	Sponge and warm, soapy water OR Paper towel and spray glass cleaner	<ul style="list-style-type: none"> • Wash, wipe with clean water, and dry thoroughly. • Do not use steel wool or abrasive cleansers. They may damage the finish. • Do not spray cleaner directly on panel. Apply cleaner to paper towel. <p>NOTE: Set the Control Lock to prevent the oven from accidentally turning on when you are cleaning the panel. (See “Using the control lock” earlier in this section.)</p>
Exterior surfaces (other than control panel)	Sponge and warm, soapy water	<ul style="list-style-type: none"> • Wash, wipe with clean water, and dry thoroughly. • Use nonabrasive, plastic scrubbing pad on heavily soiled areas. • Do not use abrasive or harsh cleansers. They may damage the finish.
Broiler pan and grid (clean after each use)	Steel-wool pad and warm, soapy water	<ul style="list-style-type: none"> • Wash, rinse, and dry thoroughly. • Do not clean in Self-Cleaning cycle. See “Before you start” in the “Using the Self-Cleaning Cycle” section.

continued on next page





Using and Caring for Your Oven

PART	WHAT TO USE	HOW TO CLEAN
Oven racks	Steel-wool pad and warm, soapy water OR The Self-Cleaning cycle	<ul style="list-style-type: none">• Wash, rinse, and dry thoroughly. OR <ul style="list-style-type: none">• Leave in oven during Self-Cleaning cycle. NOTE: Racks will permanently discolor and become harder to slide if left in oven during the Self-Cleaning cycle. Apply a small amount of vegetable oil to the side rungs to aid sliding.
Oven door glass	Paper towel and spray glass cleaner OR Warm, soapy water, and a nonabrasive, plastic scrubbing pad	<ul style="list-style-type: none">• Make sure oven is cool.• Follow directions provided with the cleaner.• Wash, wipe with clean water, and dry thoroughly.
Oven cavity	Self-Cleaning cycle	<ul style="list-style-type: none">• Wipe up food spills containing sugar as soon as possible after the oven cools down. (See “Before you start” in the “Using the Self-Cleaning Cycle” section.)• See “Using the Self-Cleaning Cycle” section.



Using and replacing the oven light(s)

Your oven may have a standard oven light or two side halogen lights. The oven light(s) will come on when you open the oven door. To turn the light(s) on when the oven door is closed, **press** the Oven Light pad  on the control panel. **Press** the pad  again to turn off the light(s).

Replacing the oven light (models with light on back wall):

1. **Unplug** range or **disconnect** power.
2. **Make sure** the oven is cool before replacing the light bulb.

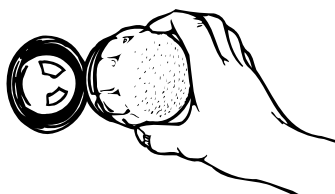

3. **Remove** the glass bulb cover in the back of the oven by turning it counterclockwise.
4. **Remove** the light bulb from its socket. **Replace** the bulb with a 40-watt appliance bulb.
5. **Replace** the light bulb cover by turning it clockwise. The light bulb cover must be in place when using the oven. The cover protects the bulb from breaking and from high oven temperatures.
6. **Plug in** range or **reconnect** power.

NOTE: The oven light will not work during the Self-Cleaning cycle.

Replacing oven lights (models with side halogen lights):

1. **Unplug** range or **disconnect** power.
2. **Make sure** the oven is cool before replacing the light bulb.

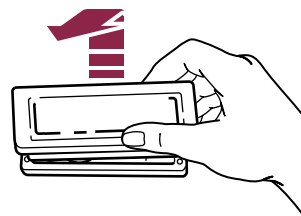

3. **Remove** glass light cover by grasping front edge of cover and pulling it away from the side wall of the oven.
4. **Remove** the light bulb from its socket. **Replace** the bulb with another halogen bulb (12 volt, 5 watt maximum, available at most hardware stores).
5. **Replace** the light cover by snapping it back into wall.
6. **Plug in** range or **reconnect** power.

NOTE: The oven lights will not work during the Self-Cleaning cycle.

Using the Self-Cleaning Cycle

The Self-Cleaning cycle saves you from the toil and mess that often come with hand-cleaning the oven interior. Like the other functions of your oven, you operate the Self-Cleaning cycle with the easy-to-use electronic control. To use this cycle properly, follow the step-by-step instructions in this section.

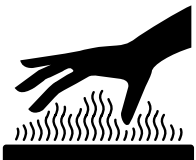
	⚠ WARNING
	Burn Hazard Do not touch the oven during the Self-Cleaning cycle. Keep children away from oven during Self-Cleaning cycle. Do not use commercial oven cleaners in your oven. Failure to follow these instructions can result in burns, or illness from inhaling dangerous fumes.

Before you start

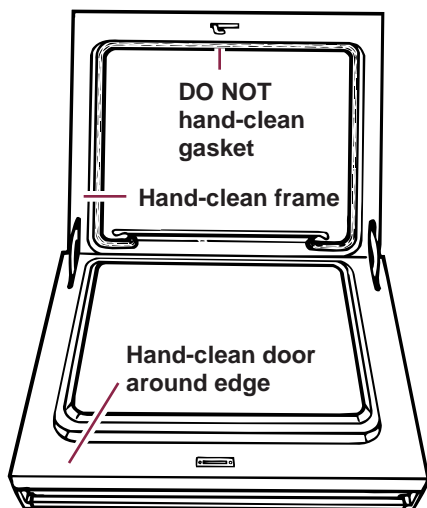

Before you start the Self-Cleaning cycle, make sure you:

- **Hand-clean the areas shown.** They do not get hot enough during the Self-Cleaning cycle for soil to burn away. Use hot water and detergent or a soapy steel-wool pad for cleaning.

NOTE: DO NOT clean, move, or bend the gasket. Poor cleaning, baking, and roasting may result.

- **Remove** the broiler pan and grid and anything else being stored in the oven.
- **Wipe out** any loose soil or grease. This will help reduce smoke during the Self-Cleaning cycle.

- **Wipe up** food spills containing sugar as soon as possible after the oven cools down. When sugar is heated to a high temperature in the Self-Cleaning cycle, the high temperature can cause the sugar to burn and react with the porcelain. This can cause staining and etching or pitting.
- **Remove** the oven racks from the oven if you want them to remain shiny. You can clean racks in the Self-Cleaning cycle, but they will discolor and become harder to slide. If you clean racks in the Self-Cleaning cycle, place them on the rack guides.
- **Heat and odors** are normal during the Self-Cleaning cycle. Keep the kitchen well-ventilated by opening a window or by turning on a vent hood or other kitchen vent during the cycle.

NOTES:

- **Do not block** the oven vent during the Self-Cleaning cycle. Air must move freely for best cleaning results.
- **Do not leave** plastic utensils on the cooktop. They may melt.
- **Do not leave** any foil in oven during the Self-Cleaning cycle. Foil could burn or melt and damage the oven surface.
- **The oven light** will not work during the Self-Cleaning cycle.



- **Do not insert** any object into the opening of the protective shield that surrounds the ignitor. Also, do not clean this area. Doing either could result in product damage.
- **Do not use** your cooktop during the Self-Cleaning cycle. Using your cooktop will turn the cycle off.

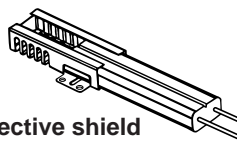

Protective shield around ignitor

Before setting the controls

- **Make sure clock is set to correct time of day.**
- **Make sure the oven door is completely closed.**

Setting the controls

To start cleaning immediately:

1. Press Clean pad.

A 3½-hour Self-Cleaning cycle will be set. (The first 3 hours are for cleaning, the last 30 minutes are for cooling.)

PRESS



YOU SEE



(stop time display shows time 3½ hours later than time of day – shown in start time display)

2. Set cleaning time (optional).

If you want a Self-Cleaning cycle other than 3½ hours, **press** the desired Number pads for the new time up to 4½ hours.

- **Use** 2½ hours for light soil.
- **Use** 3½ -4½ hours for moderate to heavy soil.

PRESS

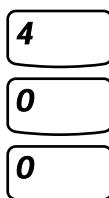

YOU SEE



(example shows 4-hour cleaning cycle with stop time now 4 hours later than time of day)

3. Start oven.

NOTE: The door will lock right after you press START.

PRESS



YOU SEE



(for first 30 minutes)



(for remainder of cycle)

continued on next page



Using the Self-Cleaning Cycle

4. After the Self-Cleaning cycle ends:

YOU SEE



To delay cleaning start time:

1. Press Clean pad.

A 3½-hour Self-Cleaning cycle will be set. (The first 3 hours are for cleaning, the last 30 minutes are for cooling.)

PRESS



YOU SEE



(stop time display shows time 3½ hours later than time of day – shown in start time display)

2. Set cleaning time (optional).

If you want a Self-Cleaning cycle other than 3½ hours, **press** the desired Number pads for the new time up to 4½ hours.

- Use 2½ hours for light soil.
- Use 3½ -4½ hours for moderate to heavy soil.

PRESS

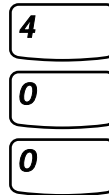

YOU SEE



(example shows 4-hour cleaning cycle with stop time now 4 hours later than time of day)

3. Press Stop Time pad.

PRESS



YOU SEE



4. Set Stop time.

Example for 7:00:

PRESS

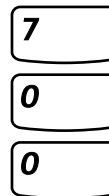

YOU SEE



(display shows stop time of 7:00 and start time of 3:00 – stop time minus cleaning time)

5. Complete entry.

NOTE: The door will lock right after you press START.

PRESS



YOU SEE





When the start time is reached:

NOTE: After 30 minutes, the broil burner symbol will turn off and the bake burner symbol will turn on.

YOU SEE



6. After the Self-Cleaning cycle ends:

NOTE: You can run a second Self-Cleaning cycle right after "DOOR LOCKED" disappears from the display.

YOU SEE



To stop the Self-Cleaning cycle at any time:

PRESS



YOU SEE



("DOOR LOCKED" will appear if oven has not cooled down)

For best cleaning results

- After the oven cools to room temperature, wipe up any residue or ash with a damp cloth or sponge. If any spots remain, clean with a mildly abrasive cleanser or cleaning sponge.
- Clean the oven before it gets heavily soiled. Cleaning a very soiled oven takes longer and results in more smoke than usual.
- If the Self-Cleaning cycle does not get the oven as clean as you expected, the cycle may not have been set long enough or you may not have prepared the oven properly. Set the Self-Cleaning cycle longer the next time and hand-clean areas noted in "Before you start" earlier in this section.

How the cycle works

The Self-Cleaning cycle uses very high heat to burn away soil and grease. During the cycle, the oven gets much hotter than it does for normal baking or broiling. This high heat breaks up the soil or grease and burns it away.

Your oven is preset for a 3½-hour Self-Cleaning cycle. However, you can adjust the cycle time to the amount of soil in your oven. You can set the cycle anywhere between 2½ and 4½ hours. (See "Setting the controls" earlier in this section.)

The graph at the right is representative of a normal, 3½-hour Self-Cleaning cycle. Note that the heating stops after 3 hours, but it takes longer for the oven to cool enough to unlock the door.

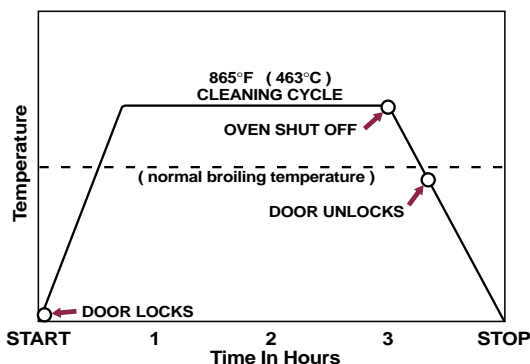

Troubleshooting

Most cooking problems often are caused by little things you can find and fix without tools of any kind. Check the lists below and on the next two pages before calling for assistance or service. If you still need help, see “Requesting Assistance or Service” on page 67.

If nothing operates, check the following:

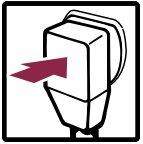

Is the range plugged or wired into a live outlet or circuit with the proper voltage?
(See Installation Instructions.)



Have you blown a household fuse or tripped a circuit breaker?

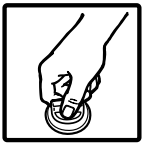

Have you set the control knob or electronic control correctly?

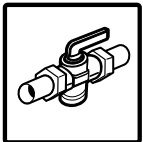

Is the range properly connected to gas supply? Contact an authorized servicing outlet to reconnect range to gas supply. (See Installation Instructions.)



Is the flow of combustion and/or ventilation air to the cooktop blocked?

Other problems and their causes:

PROBLEM	CAUSE
The oven will not operate	<ul style="list-style-type: none"> • You have not set the electronic control correctly. Refer to the section in this manual describing the function you are operating. • You have programmed a delayed start time. Wait for the start time to be reached or cancel and reset the control.
Burner fails to light	<ul style="list-style-type: none"> • The range is not plugged or wired into a live outlet or circuit with the proper voltage. (See Installation Instructions.) • You have blown a household fuse or tripped a circuit breaker. In case of prolonged power failure, manually light burners. (See page 13.) • The burner ports are clogged. Clean with a straight pin. (See page 15.)
Burner flames are uneven	<ul style="list-style-type: none"> • The burner ports are clogged. Clean with a straight pin. (See page 15.) If this fails, call for service.
Burner flames lift off ports, are yellow, or are noisy when turned off	<ul style="list-style-type: none"> • The air/gas mixture is incorrect. Contact a service technician to check it.
Burner makes popping noise when on	<ul style="list-style-type: none"> • The burner is wet from washing. Let dry.
Burners spark	<ul style="list-style-type: none"> • It is normal for all four burners to spark briefly when: <ul style="list-style-type: none"> – A burner is turned on, but has not yet ignited. – There is a draft blowing on burners. – A very large pot on burner causes flame to be unstable. No action is needed. Burner operation is not affected and the sparking should end when the ignited flame is burning undisturbed. • Continuous sparking may be caused when: <ul style="list-style-type: none"> – A spillover has wet ignition switch contacts. Turn on one or two burners or disconnect electrical supply to let switch dry out. – There is a faulty spark module. Contact a service technician to replace module. – The wall outlet wiring is incorrect. Contact a qualified electrician to correct wiring, if needed.
Cooling fan runs during Bake or Broil	<ul style="list-style-type: none"> • It is normal for the fan to automatically run during Bake or Broil to cool the electronic control.

continued on next page



PROBLEM	CAUSE
The control knob(s) will not turn	<ul style="list-style-type: none">• You are not pushing in before turning.
The Self-Cleaning cycle will not operate	<ul style="list-style-type: none">• You have programmed a delayed start time. Wait for the start time to be reached or cancel and reset the control.• The cooling fan is not running. If fan is running, you can hear it. Call a service technician for repair.
Cooking results are not what you expected	<ul style="list-style-type: none">• The range is not level. (See Installation Instructions.)• The oven temperature seems too low or too high. See “Adjusting oven temperature” on page 37 to adjust oven temperature.• You did not preheat the oven before baking (if called for in recipe).• You are using a pan that is not the correct type or size. Refer to a reliable cookbook or recipe for recommended pan type and size.• There is not enough air space around pan when baking. Allow 1½ to 2 inches (3 to 5 cm) of air space on all sides of pan.• The cookware is too large or too small for the surface burner being used. Pan should be the same size or slightly larger than the surface burner being used.• The flame is not the correct size for the cookware being used.
The display is showing “PF”	<ul style="list-style-type: none">• There has been a power failure. Reset the clock. (See page 29.)
A letter followed by a number shows on the display (for example “E3,” “F1”)	<ul style="list-style-type: none">• Press CANCEL/OFF. If the code does not disappear, call for service. (See Step 2 on pages 67 or 68.)• The power cord is not properly grounded. (See Installation Instructions.)
The key pads do not operate	<ul style="list-style-type: none">• The Control Lock has been set. (See “Using the control lock” on page 24.) Turn off the Control Lock by pressing and holding the Control Lock pad (Number Pad 3) for 5 seconds.• The Sabbath mode has been set (“SAb” appears on the display). Turn off the Sabbath mode by opening the oven door, waiting up to 15 seconds and pressing and holding Number Pad 6 for 5 seconds.• The range is not grounded. Call a service technician to ground the range.

If none of these items was causing your problem, see “Requesting Assistance or Service” on page 67.

Requesting Assistance or Service

If you need assistance or service in the U.S.A.:

1. If the problem is not due to one of the items listed in the "Troubleshooting" section†:

- Call the KitchenAid Consumer Assistance Center:



1-800-422-1230

One of our trained consultants can instruct you in how to

obtain satisfactory operation from your appliance or, if service is necessary, recommend a qualified service company in your area.

- If you prefer, write to:

KitchenAid Brand Home Appliances
Consumer Assistance Center
c/o Correspondence Dept.
2000 North M-63

Benton Harbor, MI 49022-2692

Please include a daytime phone number in your correspondence.

2. If you need service†:

- Call your dealer or the repair service he recommends.



- All service should be handled locally by the dealer from whom you purchased the unit or an authorized KitchenAid servicer.

- If you are unable to obtain the name of a local authorized KitchenAid servicer, call our Consumer Assistance Center telephone number (see Step 1).

† When asking for help or service:

Please provide a detailed description of the problem (including any information that appears on the electronic control display), your appliance's complete model and serial numbers, and the purchase date. (See the "A Note to You" section.) This information will help us respond properly to your request.

Don't forget, KitchenAid offers a full line of quality home appliances.

Built-In Refrigerators

Trash Compactors

Ranges & Cooktops

Freestanding Refrigerators

Hot Water Dispensers

Microwave Ovens

50-Pound Ice Makers

Food Waste Disposers

Washers & Dryers

Dishwashers

Built-In Ovens

Mixers & Blenders

For more information on these appliances, or the one you have purchased, call our toll free Consumer Assistance Center telephone number, **1-800-422-1230**.



If you need assistance or service in Canada:

1. If the problem is not due to one of the items listed in "Troubleshooting"† ...

Contact the dealer from whom you purchased your appliance, or call the KitchenAid Canada Consumer Assistance Centre toll free, **8:30 a.m. – 6 p.m. (EST), at 1-800-461-5681.**



2. If you need service† ...

Contact your nearest KitchenAid Canada Appliance Service branch or authorized servicing outlet to service your appliance. (See list below.)

† When asking for help or service: Please provide a detailed description of the problem, your appliance's complete model and serial numbers, and the purchase date. (See the "A Note to You" section.) This information will help us respond properly to your request.

KitchenAid Canada Appliance Service – Consumer Services

Direct service branches:

BRITISH COLUMBIA		1-800-665-6788
ALBERTA		1-800-661-6291
ONTARIO (except 807 area code)	Ottawa area	1-800-267-3456
	Outside the Ottawa area	1-800-807-6777
MANITOBA, SASKATCHEWAN and 807 area code in ONTARIO		1-800-665-1683
QUEBEC	Montreal (except South Shore)	1-800-361-3032
	South Shore Montreal	1-800-361-0950
	Quebec City	1-800-463-1523
	Sherbrooke	1-800-567-6966
ATLANTIC PROVINCES		1-800-565-1598

For further assistance

If you need further assistance, you can write to KitchenAid Canada with any questions or concerns at:

Consumer Relations Department
KitchenAid Canada
1901 Minnesota Court
Mississauga, Ontario L5N 3A7

Please include a daytime phone number in your correspondence.

Index

This index is alphabetical. It contains all the topics included in this manual, along with the page(s) on which you can find each topic.

TOPIC	PAGE	TOPIC	PAGE
ANTI-TIP BRACKET	10	COOKWARE	
ASSISTANCE	67, 68	Canning	14
BAKING		Pans	14
Aluminum foil	5, 35	DEHYDRATING	54
Pans	34	EASY CONVECT* Conversion	44
Setting cycle	32	ENERGY SAVING TIPS	14
Tips	34, 35	FEATURES	7, 8
BROILING		LIGHT(S)	
Chart	50	Cooktop	18
Grid	47	Oven	59
Pan	47	Surface	18
Setting cycle	46	LOCK	
Tips	49	Control	24
CLEANING		Self-cleaning cycle	61, 62
Cooktop	17	MODEL AND SERIAL NUMBER	3
Oven	57, 58	OVEN TEMPERATURE	
Self-cleaning	60	Adjusting	37
CONTROL PANEL		Setting	32, 33, 38, 40, 42, 44, 46, 48, 51, 52, 55
Canceling	28	PARTS	7, 8
Clock	29	PROOFING BREAD	56
Command pads	30	RACKS	
Control lock	24	Convection roasting rack	36
Display	20	Placement	35
Fahrenheit/celsius conversion	21	Positions	35
Number pads	20	ROASTING	
Power failure	28	Rack	36
Sabbath feature	25, 26, 27	Setting cycle	33
Settings	23, 24	Tips	36
Signals	22, 23	SAFETY	4-6
Starting	28	SELF-CLEANING	
Timer	30	Delay cleaning	62
Tones	22, 23	How cycle works	63
CONVECT FULL MEAL	42	Preparing oven	60
CONVECTION BAKING		Setting controls	61
Pans	34	Starting immediately	61
Setting cycle	43	Stopping cycle	63
Tips	35	Tips	63
CONVECTION BROILING	48	SERVICE	67, 68
COOKTOP			
Caring for	15		
Cleaning	17		
Using	11-13		

<u>TOPIC</u>	<u>PAGE</u>	<u>TOPIC</u>	<u>PAGE</u>
STORAGE DRAWER		Power failure	13
Removing	9	When to use	11
Replacing	9	TEMPERATURE PROBE	
SURFACE BURNERS		Cleaning	41
Caps	15, 17	Connecting to oven	39
Control knobs	12, 17	Inserting in food	39
Flame	13, 15, 16	Setting cycle	40
Gas tube openings	15	TIMED COOKING	
Grates	17	Canceling	54
Heat settings	12, 13	Cook time	52, 53
How they work	11, 12	Stop time	53
How to use	12, 13	TROUBLESHOOTING	64
Ignitors	12	WARRANTY	72
L.P. gas conversion kit	11		
Ports	15, 16		

KitchenAid^{*}

Gas Range

Warranty

LENGTH OF WARRANTY:	KITCHENAID WILL PAY FOR:	KITCHENAID WILL NOT PAY FOR:
ONE-YEAR FULL WARRANTY FROM DATE OF PURCHASE	Replacement parts and repair labor costs to correct defects in materials or workmanship. Service must be provided by an authorized KitchenAid servicing outlet.	A. Service calls to: <ol style="list-style-type: none"> 1. Correct the installation of the range. 2. Instruct you how to use the range. 3. Replace house fuses or correct house wiring. 4. Correct house plumbing. B. Repairs when range is used in other than normal home use. C. Damage resulting from accident, alteration, misuse, abuse, fire, flood, acts of God, improper installation, or installation not in accordance with local electrical or plumbing codes. D. Any labor costs during the limited warranties. E. Replacement parts or repair labor costs for units operated outside the United States and Canada. F. Pickup and delivery. This product is designed to be repaired in the home. G. Repairs to parts or systems resulting from unauthorized modifications made to the appliance. H. In Canada, travel or transportation expenses for customers who reside in remote areas.
SECOND-THROUGH FIFTH-YEAR LIMITED WARRANTY FROM DATE OF PURCHASE	Replacement parts for any gas burner to correct defects in materials or workmanship. Replacement parts for solid state touch control system to correct defects in materials or workmanship.	
SECOND-THROUGH TENTH-YEAR LIMITED WARRANTY FROM DATE OF PURCHASE	Replacement parts for the porcelain oven cavity/inner door if the part rusts through due to defects in materials or workmanship.	

9/97

KITCHENAID AND KITCHENAID CANADA DO NOT ASSUME ANY RESPONSIBILITY FOR INCIDENTAL OR CONSEQUENTIAL DAMAGES. Some states or provinces do not allow the exclusion or limitation of incidental or consequential damages, so this exclusion or limitation may not apply to you. This warranty gives specific legal rights and you may also have other rights which vary from state to state or province to province.

Outside the United States and Canada, a different warranty may apply. For details, please contact your authorized KitchenAid dealer.

If you need assistance or service, first see the "Troubleshooting" section of this book. After checking "Troubleshooting," additional help can be found by checking the "Requesting Assistance or Service" section. In the U.S.A., call our Consumer Assistance Center at **1-800-422-1230**. In Canada, call KitchenAid Canada at one of the telephone numbers listed in the "Requesting Assistance or Service" section.

KitchenAid
 Benton Harbor, Michigan 49022-2692 U.S.A.

PART NO. 9752684 Rev. A

© 1997 KitchenAid

* Trademark of KitchenAid, U.S.A.,
 KitchenAid Canada licensee in Canada

9/97
 Printed in U.S.A.