

INTERVAL TIME = 30 SECONDS  
 ▽ = DETENT

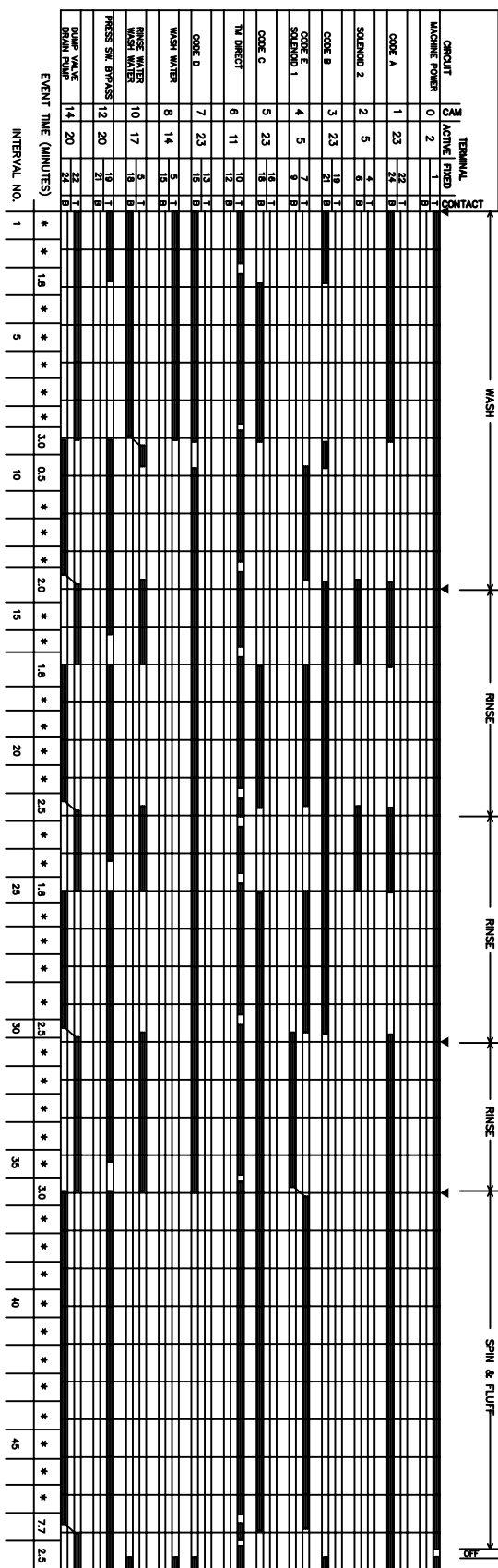

**WARNING** TO REDUCE THE RISK OF ELECTRICAL SHOCK DISCONNECT THIS APPLIANCE FROM THE POWER SUPPLY BEFORE ATTEMPTING ANY USER MAINTENANCE. TURNING THE CONTROLS TO THE OFF POSITION DOES NOT DISCONNECT THIS APPLIANCE FROM THE POWER SUPPLY.

**WIRING CODES**

- CONNECTION
- + NO CONNECTION
- ⏏ CABINET GROUND
- ▽ LOCAL GROUND

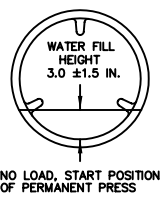
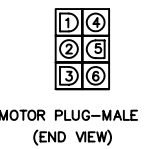

**TEMPERATURE SWITCH**

	CIRCUIT		
	1-3	1-5	2-6
WASH		X	
COLD	X		
WARM	X	X	
DELIC	X	X	X
HOT	X		

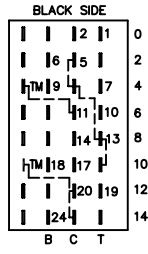
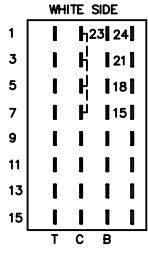

**COMPONENT RESISTANCE TABLE**

ELECTRICAL COMPONENT	RESISTANCE Ω @ 77° F
WATER VALVE SOLENOIDS	880 ±10%
DOOR LOCK SOLENOID	380 ±10%
TIMER MOTOR	2425 ±6%
PUMP MOTOR	15 ±7%
DISPENSER VALVE SOLENOIDS	1100 ±7%
MOTOR	M1 TO M2 2.6 ±7%
	M2 TO M3 2.6 ±7%
	M1 TO M3 2.6 ±7%
	M5 TO M6 184 ±7%

WIRING DIAGRAM 134832800 B



TABLEAU DE RESISTANCE DES COMPOSANTS		
COMPOSANT ELECTRIQUE	RESISTANCE Ω @ (25° C)	
SOLENOÏDE DU ROBINET D'EAU	880 ±10%	
SOLENOÏDE DU LOQUET DE PORTE	380 ±10%	
MOTEUR DE MINUTERIE	2425 ±6%	
MOTEUR DE POMPE	15 ±7%	
SOLENOÏDE DU ROBINET DISTRIBUTEUR	1100 ±7%	
MOTEUR	M1 VERS M2	2.6 ±7%
	M2 VERS M3	2.6 ±7%
	M1 VERS M3	2.6 ±7%
	M5 VERS M6	184 ±7%

LAVAGE	CIRCUIT		
	1-3	1-5	2-6
FROID	X	X	
T/F	X	X	X
T/T	X	X	X
C/F	X	X	X

X=FERME

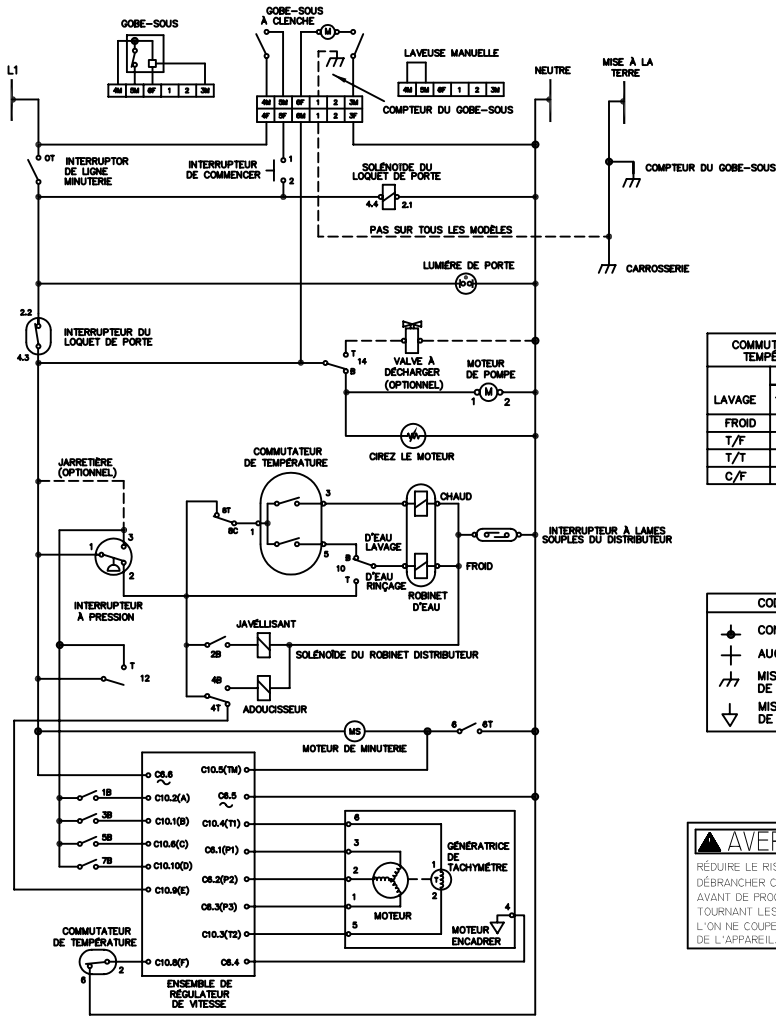
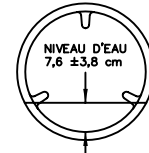
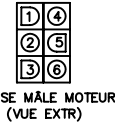

SANS CHARGE, POSITION DE DEMARRAGE DU CYCLE POUR

CODES DE CABLAGE	
•	CONNEXION
+	AUCUNE CONNEXION
⏏	MISE A LA TERRE DE CARROSSERIE
⏏	MISE A LA TERRE DE LOCAL

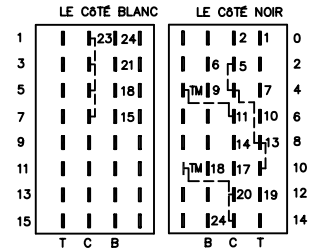

PRISE MÂLE MINUT (VUE EXTR)

**AVERTISSEMENT** POUR RÉDUIRE LE RISQUE DE CHOC ÉLECTRIQUE, DÉBRANCHER CET APPAREIL DE L'ALIMENTATION AVANT DE PROCÉDER À L'ENTRETIEN. EN TOURNANT LES COMMANDES A LA POSITION ARRÊT, L'ON NE COUPE PAS L'ALIMENTATION ÉLECTRIQUE DE L'APPAREIL.

SCHEMA DE CABLGE 134832800 B



TABLA DE RESISTENCIA DE LOS COMPONENTES		
COMPONENTE ELECTRIICO	RESISTENCIA Ω @ 25° C	
SOLENOIDE DE LA VÁLVULA DEL AGUA	880 ±10%	
SOLENOIDE DE CIERRE DE LA PUERTA	380 ±10%	
MOTOR DE CONTADOR DE TIEMPO	2425 ±6%	
BOMBA DE MOTOR	15 ±7%	
SOLENOIDE DE LA VÁLVULA DEL DISTRIBUIDOR	1100 ±7%	
MOTOR	M1 A M2	2.6 ±7%
	M2 A M3	2.6 ±7%
	M1 A M3	2.6 ±7%
	M5 A M6	184 ±7%

LAVADO	CIRCUITO		
	1-3	1-5	2-6
FRIJO	X	X	
TEMPLADO	X	X	X
DELICADO	X	X	X
CALIENTE	X	X	X

X=CERRADO

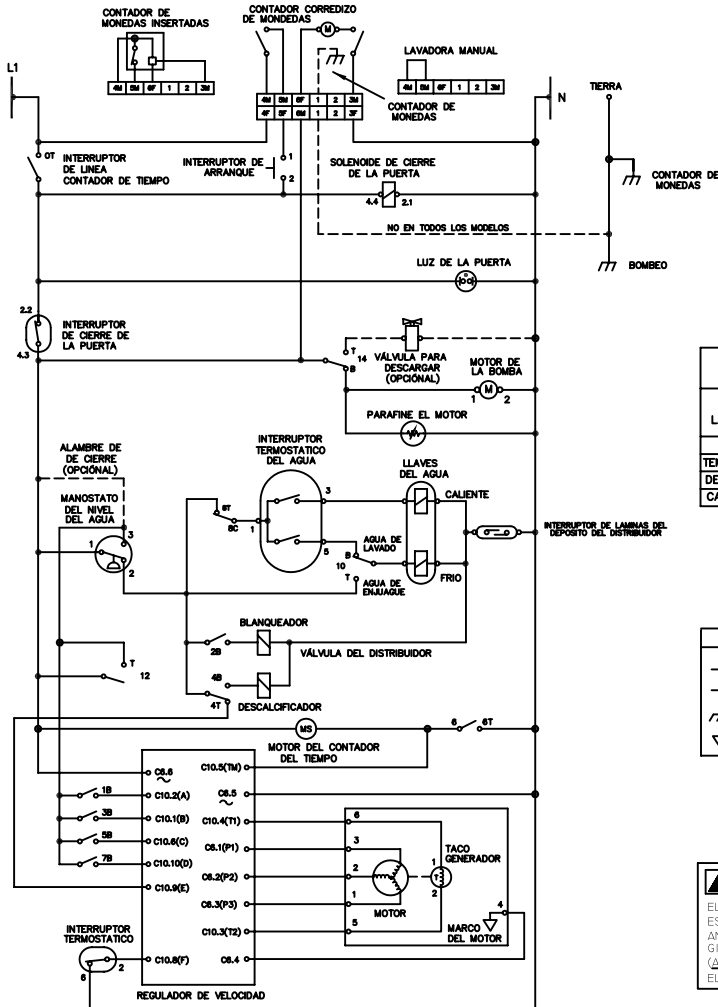

SIN CARGA, POSICIÓN DE ARRANQUE DEL CICLO PARA TALAS DE PLANCHADO PERMANENTE.

CODIGOS DEL CABLEADO	
•	CONNEXION
+	SIN CONNEXION
⏏	PUESTA A TIERRA DE CAJA
⏏	PUESTA A TIERRA DE LOCAL

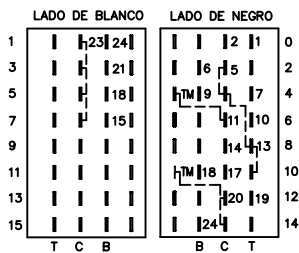

FICHA DE CONTADOR DE MACHO TIEMPO (VISTA DE EXTREMO)

**ADVERTENCIA** PARA REDUCIR EL RIESGO DE CHOCQUE ELÉCTRICO, DESENCHUFE ESTE APARATO DE LA ALIMENTACIÓN ELÉCTRICA ANTES DE EFECTUAR EL MANTENIMIENTO. AL GIRAR LOS CONTROLES A LA POSICIÓN OFF (APAGADO) NO SE CORTA LA ALIMENTACIÓN ELÉCTRICA AL ARTEFACTO.

DIAGRAMA DE CONEXIONES NO. DE PIEZA 134832800 B

# TECH SHEET - RETAIN FOR SERVICE TECHNICIAN



**WARNING** Disconnect from Electrical Supply Before Servicing Washer.

## WIRING DIAGRAM

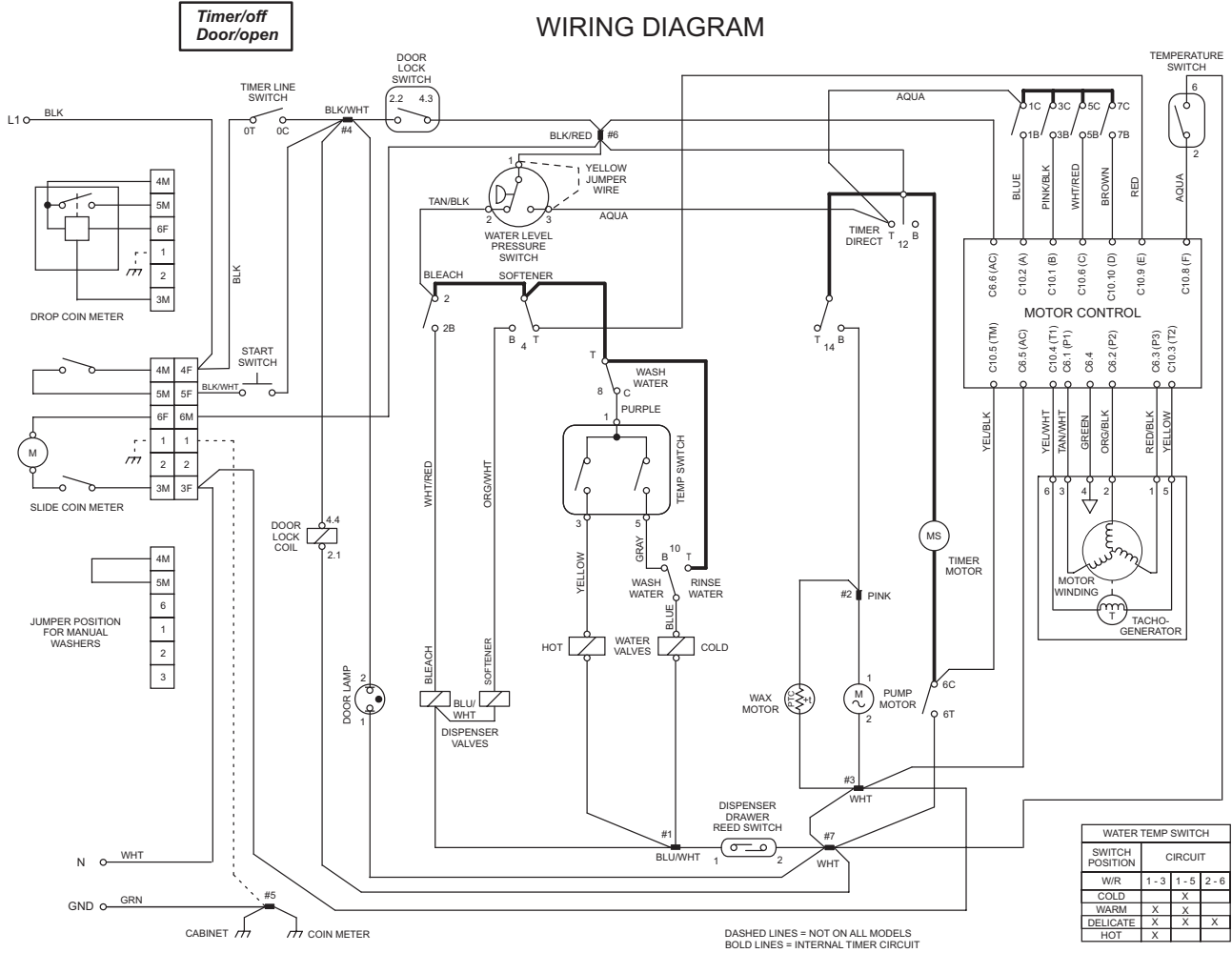

SWITCH POSITION	CIRCUIT		
W/R	1-3	1-5	2-6
COLD		X	
WARM	X	X	
DELICATE	X	X	X
HOT	X		

### Motor Will Not Run

- CHECK FOR POWER:** Advance the timer knob to the drain increment. If the drain pump does not run, check household safety circuit. If the drain pump runs go to step 2.
- CHECK FOR MOTOR MOVEMENT:** Turn the water off to the washer. Remove electrical power from the washer and remove the back panel. Remove the motor drive belt. Reconnect electrical power and set the timer to the start of the Regular wash cycle and pull the knob out. If motor does not rotate, check for a poor connection in the timer line switch, coin box circuit, or door lock switch. If good, and motor does not run go to Step 3.
- MEASURE VOLTAGES:** Remove the six pin plug from the speed control unit. Measure the voltage between pins 5 and 6 on the harness. If the meter reads 0 check the connection in the timer line switch or door lock. If the meter reads 120 Vac go to step 4.

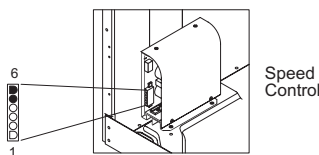

- Set the timer to the Heavy Wash position of the Regular wash cycle. Remove the ten pin plug from the speed control unit. Measure the voltage between pins 1, 2, 6 and 10 of the ten pin plug to pin 5 of the 6 pin plug on the harness. The voltage at pins 2, 6, and 10 should read 120 Vac and 0 Vac at pin 1. If not, check timer contacts 1C to 1B, 5C to 5B, and 7C to 7B for closed contacts, and 3C to 3B for open contacts. If the voltage readings are correct, go to step 5.

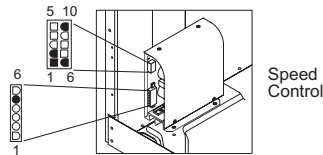

- MEASURE RESISTANCES:** Check the fuse on the speed control board. If the fuse is open, replace the speed control board. If good, go to step 6.
- Remove the 6 pin plug from the speed control unit. Measure the resistance between pins 1 and 2, 2 and 3, and 3 and 1 of the speed control unit. If the meter reads other than 3 Meg ohms  $\pm$  10%, replace the speed control board.

- Remove electrical power from the washer. With an ohmmeter check the resistance between pins 1 and 2, 2 and 3, and 3 and 1 of the six pin plug on the harness. If the meter reads other than 2.6 ohms  $\pm$  7%, replace the motor.

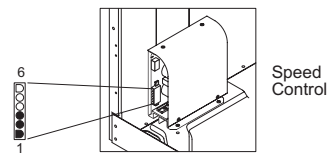

### Quick Facts

- The timer motor will not run continuously. The speed control unit controls the timer motor and advances the timer when needed.
- In some tumble modes, the tub may not tumble for the first 16 to 20 seconds after start-up.
- Extremely low water pressure may cause tub rotation to stop until WLC satisfied.

### IMPORTANT SAFETY NOTICE

This information is intended for use by technicians possessing adequate background of electrical, electronic and mechanical experience. Any attempt to repair a major appliance may result in personal injury and property damage. The manufacturer or seller cannot be responsible for the interpretation of this information, nor can it assume any liability in connection with its use.

### IMPORTANT

If grounding wires, screws or clips used to complete a path to ground are removed for service, they must be returned to their original position and properly fastened. Certain internal parts are intentionally NOT grounded and may present a risk of electric shock only during servicing. Do not contact the following parts while the appliance is energized: pump, drive motor and electronic control boards.

# WARNING

This information is intended for use by persons having electrical and mechanical training and a level of knowledge of these subjects generally considered acceptable in the appliance repair trade. The seller or manufacturer cannot be responsible, nor assume any liability, for injury or damage of any kind arising from the use of this data.

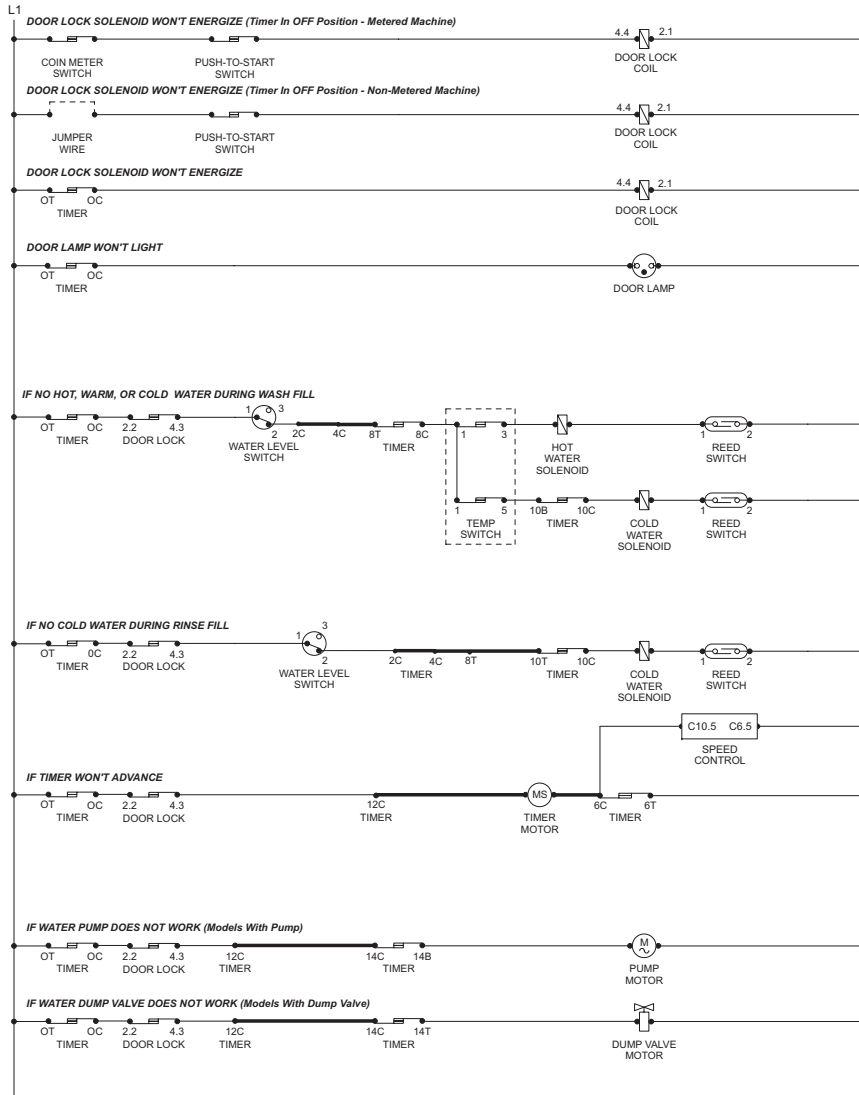

NOTE: BOLD LINES INDICATE INTERNAL TIMER CIRCUITS.

## IMPORTANT

Reconnect all grounding devices, all parts of this appliance capable of conducting electrical current are grounded. If grounding wires, screws, straps, clips, nuts or washers used to complete a path to ground are removed for service, they must be returned to their original position and properly fastened.

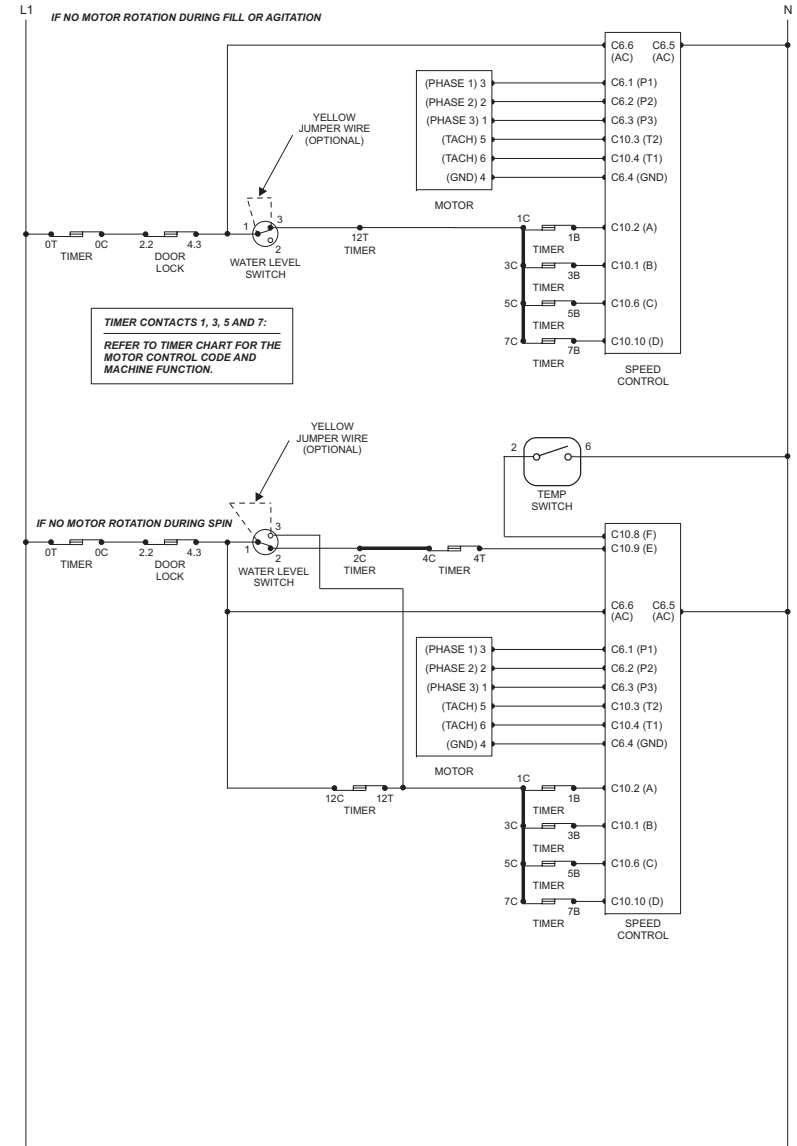

## DIAGNOSTIC STRIP CIRCUITS