

20" and 24" Gas
Ranges

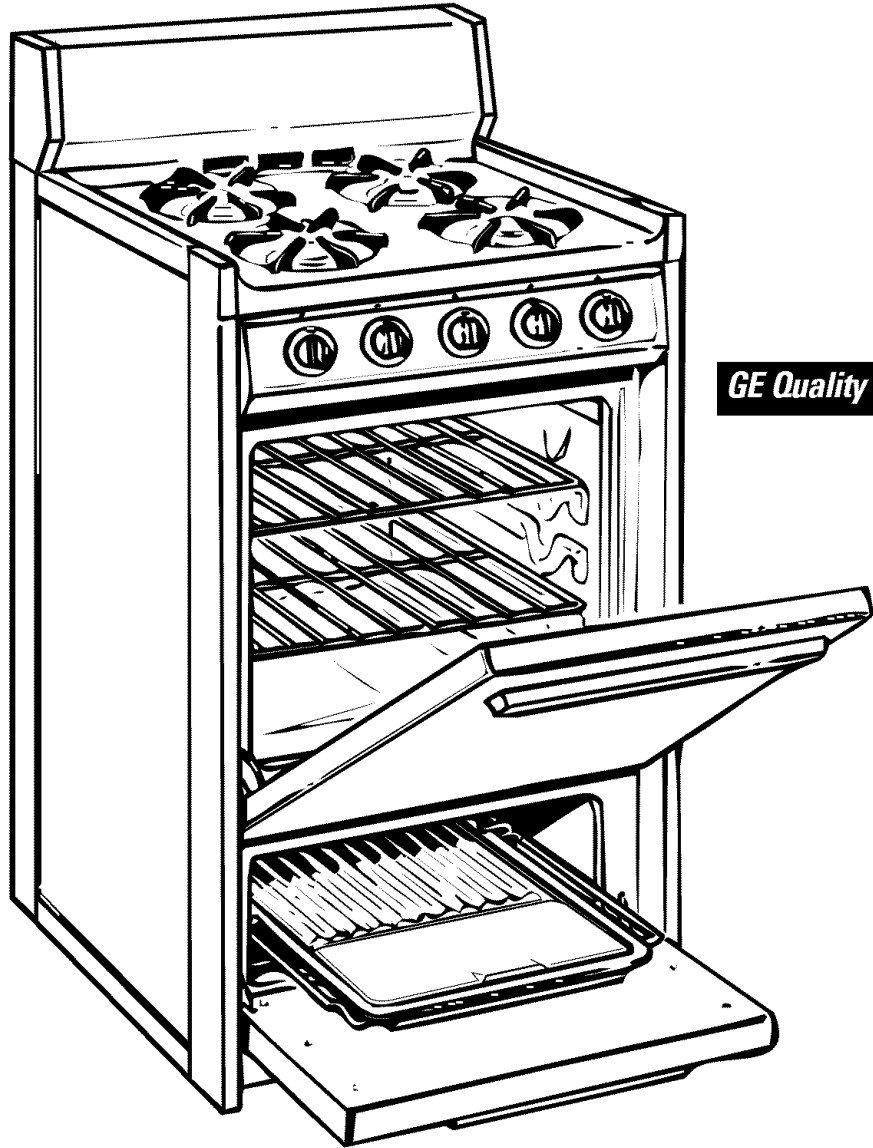

GE Quality Product

**IMPORTANT SAFETY INFORMATION.
 READ ALL INSTRUCTIONS BEFORE USING.**

⚠ WARNING!
IMPORTANT SAFETY NOTICE



The California Safe Drinking Water and Toxic Enforcement Act requires the Governor of California to publish a list of substances known to the state to cause cancer, birth defects or other reproductive harm, and requires businesses to warn customers of potential exposure to such substances.

Gas appliances can cause minor exposure to four of these substances, namely benzene, carbon monoxide, formaldehyde and soot, caused primarily by the incomplete combustion of natural gas or LP fuels. Properly adjusted burners, indicated by a bluish rather than a yellow flame, will minimize incomplete combustion. Exposure to these substances can be minimized by venting with an open window or using a ventilation fan or hood.

WARNING: If the information in this manual is not followed exactly, a fire or explosion may result causing property damage, personal injury or death.

- Do not store or use gasoline or other flammable vapors and liquids in the vicinity of this or any other appliance.
- **WHAT TO DO IF YOU SMELL GAS**
 - Do not try to light any appliance.
 - Do not touch any electrical switch; do not use any phone in your building.
 - Immediately call your gas supplier from a neighbor's phone. Follow the gas supplier's instructions.
 - If you cannot reach your gas supplier, call the fire department.
- Installation and service must be performed by a qualified installer, service agency or the gas supplier.



⚠ WARNING!
ANTI-TIP DEVICE

- ALL RANGES CAN TIP
- INJURY TO PERSONS COULD RESULT
- INSTALL ANTI-TIP DEVICES PACKED WITH RANGE
- SEE INSTALLATION INSTRUCTIONS

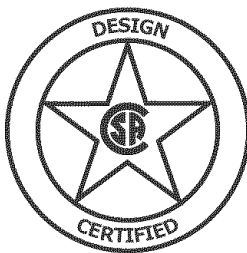

Congratulations! You Are Now Part of Our Family.

Welcome to the family. We're proud of our quality products and we are committed to providing dependable service. You'll see it in this easy-to-use Owner's Manual and you'll hear it in the friendly voices of our customer service department.

Best of all, you'll experience these values each time you use your range. That's important, because your new range will be part of your family for many years. And we hope you will be part of ours for a long time to come.

We thank you for buying our product. We appreciate your purchase, and hope you will continue to rely on us whenever you need quality appliances for your home.

A Service Partnership.



IMPORTANT!

Fill out and return the Consumer Product Registration Card that is packed with this product.



FOR YOUR RECORDS

Write the model and serial numbers here:

You can find them on a label under the cooktop on the right side wall.

Staple sales slip or cancelled check here.

Proof of the original purchase date is needed to obtain service under the warranty.



READ THIS MANUAL

Inside you will find many helpful hints on how to use and maintain your range properly. Just a little preventive care on your part can save you a great deal of time and money over the life of your range.



IF YOU NEED SERVICE

You'll find many answers to common problems in the *Before You Call For Service* section. If you review our chart of *Troubleshooting Tips* first, you may not need to call for service at all.

If you do need service, you can relax knowing help is only a phone call away. A list of toll-free customer service numbers is included in the back section of this manual.

Safety Information

Anti-Tip Device	4
Safety Precautions	4, 5
Oven	5
Surface Cooking Units	6

Operating Instructions

Using the Surface Burners	8, 9
Using the Oven	10–17

Care and Cleaning

Lift-Up Cooktop	18
Burners	19
Oven Shelves	19
Removable Oven Bottom	20
Lift-Off Oven Door	21
Porcelain Oven Interior	22

Installation Instructions

Before You Begin	23
Dimensions & Clearances	24
Anti-Tip Device	27
Connect the Range to Gas	29
Air Shutter Adjustment	32

Troubleshooting Tips

Before You Call For Service	34
--------------------------------	----

Customer Service

Warranty	35
Service Telephone Numbers	Back Cover

Safety Instructions

Operating Instructions

Care and Cleaning

Installation Instructions

Troubleshooting Tips

Customer Service

IMPORTANT SAFETY INFORMATION. READ ALL INSTRUCTIONS BEFORE USING.

⚠ WARNING!

For your safety, the information in this manual must be followed to minimize the risk of fire or explosion, electric shock, or to prevent property damage, personal injury, or loss of life.



⚠ WARNING ANTI-TIP DEVICE

All ranges can tip and injury could result. To prevent accidental tipping of the range, attach an approved Anti-Tip device to the floor. (See Installation Instructions.)



To check if the device is installed and engaged properly, carefully tip the range forward. The Anti-Tip device should engage and prevent the range from tipping over.



If you pull the range out from the wall for any reason, make sure the Anti-Tip device is engaged when you push the range back against the wall. If it is not, there is a possible risk of the range tipping over if you or a child stand, sit or lean on an open door.



SAFETY PRECAUTIONS

Be sure all packing materials are removed from the range before operating it to prevent fire or smoke damage should the packing material ignite.

- Have the installer show you the location of the range gas cut-off valve and how to shut it off if necessary.
- Have your range installed and properly grounded by a qualified installer, in accordance with the Installation Instructions. Any adjustment and service should be performed only by qualified gas range installers or service technicians.
- Plug your range into a 120-volt grounded outlet only. Do not remove the round grounding prong from the plug. If in doubt about the grounding of the home electrical system, it is your personal responsibility and obligation to have an ungrounded outlet replaced with a properly grounded, three-prong outlet in accordance with the National Electrical Code NFPA-70 latest edition. In Canada, the appliance must be electrically grounded in accordance with the Canadian Electrical Code. Do not use an extension cord with this appliance.
- Do not attempt to repair or replace any part of your range unless it is specifically recommended in this manual. All other servicing should be referred to a qualified technician.
- Locate range out of kitchen traffic path and out of drafty locations to prevent pilot outage (on standing pilot models) and poor air circulation.
- Be sure your range is correctly adjusted by a qualified service technician or installer for the type of gas (natural or LP) that is to be used. Your range can be converted for use with either type of gas. See the Installation Instructions.
- **WARNING:** These adjustments must be made by a qualified service technician in accordance with the manufacturer's instructions and all codes and requirements of the authority having jurisdiction. Failure to follow these instructions could result in serious injury or property damage. The qualified agency performing this work assumes responsibility for the conversion.
- After prolonged use of a range, high floor temperatures may result and many floor coverings will not withstand this kind of use. Never install the range over vinyl tile or linoleum that cannot withstand such type of use. Never install it directly over interior kitchen carpeting.
- Do not leave children alone or unattended where a range is hot or in operation. They could be seriously burned.
- Do not allow anyone to climb, stand or hang on the door, broiler drawer or range top. They could damage the range and even tip it over, causing severe personal injury.
- Clean only parts listed in this manual.

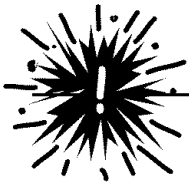

SAFETY PRECAUTIONS

Never wear loose fitting or hanging garments while using the appliance. Be careful when reaching for items stored in cabinets over the cooktop. Flammable material could be ignited if brought in contact with flame or hot oven surfaces and may cause severe burns.

- Let burner grates and other surfaces cool before touching them or leaving them where children can reach them.
- For your safety, never use your appliance for warming or heating the room.
- Do not use water on grease fires. Never pick up a flaming pan. Turn off burner, then smother flaming pan by covering pan completely with well-fitting lid, cookie sheet or flat tray. Flaming grease outside a pan can be put out by covering with baking soda or, if available, a multi-purpose dry chemical or foam-type fire extinguisher.
- Do not store flammable materials in an oven, a range broiler drawer or near a cooktop.
- Do not store or use combustible materials, gasoline or other flammable vapors and liquids in the vicinity of this or any other appliance.
- Do not let cooking grease or other flammable materials accumulate in or near the range.
- **CAUTION:** Items of interest to children should not be stored in the cabinets above a range or on the backsplash of a range—children climbing on the range to reach items could be seriously injured.



COOK MEAT AND POULTRY THOROUGHLY...

Cook meat and poultry thoroughly—meat to at least an INTERNAL temperature of 160°F. and poultry to at least an INTERNAL temperature of 180°F. Cooking to these temperatures usually protects against foodborne illness.



OVEN

Stand away from range when opening oven door. Hot air or steam which escapes can cause burns to hands, face and/or eyes.

- Do not use the oven for a storage area. Items stored in the oven can ignite.
- Place the oven shelves in the desired position while the oven is cool.
- Keep the oven free from grease buildup.
- Pulling out the shelf to the shelf-stop is a convenience in lifting heavy foods. It is also a precaution against burns from touching hot surfaces of the door or oven walls.
- Do not heat unopened food containers. Pressure could build up and the container could burst, causing an injury.
- Do not use aluminum foil anywhere in the oven except as described in this book. Misuse could result in a fire hazard or damage to the range.
- When using cooking or roasting bags in the oven, follow the manufacturer's directions.
- Use only glass cookware that is recommended for use in gas ovens.
- After broiling, always take the broiler pan out of the range and clean it. Leftover grease in the broiler pan can catch fire the next time you use the pan.
- When broiling, if meat is too close to the flame, the fat may ignite. Trim excess fat to prevent excessive flare-ups.
- Make sure the broiler pan is in place correctly to reduce the possibility of grease fires.
- If you should have a grease fire in the broiler pan, turn off oven control, and keep broiler drawer and oven door closed to contain fire until it burns out.
- Never leave jars of fat drippings on or near your range.

IMPORTANT SAFETY INFORMATION. READ ALL INSTRUCTIONS BEFORE USING.

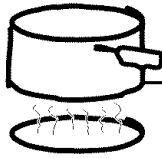

⚠ WARNING! SURFACE COOKING UNITS

Use proper pan size—Avoid pans that are unstable or easily tipped. Select cookware having flat bottoms large enough to properly contain food and avoid boilovers and spillovers and large enough to cover burner grate. This will both save cleaning time and prevent hazardous accumulations of food, since heavy spattering or spillovers left on range can ignite. Use pans with handles that can be easily grasped and remain cool.

- Always use the **LITE** position (on electric ignition models) or the **HI** position (on standing pilot models) when igniting top burners and make sure the burners have ignited.
- Never leave surface burners unattended at high flame settings. Boilover causes smoking and greasy spillovers that may catch on fire.
- Adjust the top burner flame size so it does not extend beyond the edge of the cookware. Excessive flame is hazardous.
- Use only dry pot holders—moist or damp pot holders on hot surfaces may result in burns from steam. Do not let pot holders come near open flames when lifting cookware. Do not use a towel or other bulky cloth in place of a pot holder.
- To minimize the possibility of burns, ignition of flammable materials, and spillage, turn cookware handles toward the side or back of the range without extending over adjacent burners.
- Always turn the surface burner to **OFF** before removing the cookware.
- Carefully watch foods being fried at a high flame setting.
- Never block the vents (air openings) of the range. They provide the air inlet and outlet that are necessary for the range to operate properly with correct combustion. Air openings are located at the rear of the cooktop, at the top and bottom of the oven door, and at the bottom of the range under the broiler drawer.
- Foods for frying should be as dry as possible. Frost on frozen foods or moisture on fresh foods can cause hot fat to bubble up and over sides of the pan.
- Use least possible amount of fat for effective shallow or deep-fat frying. Filling the pan too full of fat can cause spillovers when food is added.
- When flaming foods under the hood, turn the fan on.
- If a combination of oils or fats will be used in frying, stir together before heating or as fats melt slowly.
- Always heat fat slowly, and watch as it heats.
- Use a deep fat thermometer whenever possible to prevent overheating fat beyond the smoking point.
- When using glass cookware, make sure it is designed for top-of-range cooking.
- Keep all plastics away from top burners.
- Do not leave plastic items on the cooktop—they may melt if left too close to the vent.
- Do not leave any items on the cooktop. The hot air from the vent may ignite flammable items and will increase pressure in closed containers, which may cause them to burst.
- To avoid the possibility of a burn, always be certain that the controls for all burners are at the **OFF** position and all grates are cool before attempting to remove them.
- Should you have a grease fire, turn the fan off. The fan, if operating, may spread the flames.
- If range is located near a window, do not hang long curtains that could blow over the top burners and create a fire hazard.
- When a pilot goes out (on standing pilot models), you will detect a faint odor of gas as your signal to relight the pilot. When relighting the pilot, make sure burner controls are in the **OFF** position, and follow instructions in this manual to relight.
- If you smell gas, and you have already made sure pilots are lit (on standing pilot models), turn off the gas to the range and call a qualified service technician. Never use an open flame to locate a leak.
- Keep range clean and free of accumulations of grease or spillovers, which may ignite.
- Be careful when you clean the cooktop because the area over the pilot (on standing pilot models) will be hot.



FLOORING UNDER THE RANGE

Your range, like so many other household items, is heavy and can settle into soft floor coverings such as cushioned vinyl or carpeting.

When moving the range on this type of flooring, it should be installed on a 1/4" thick sheet of plywood (or similar material) as follows: **When the floor covering ends at the front of the range**, the area that the range will rest on should be built up with plywood to the same level or higher than the floor covering. This will allow the range to be moved for cleaning or servicing.



LEVELING THE RANGE

Leveling legs are located on each corner of the base of the range. Your range must be level in order to produce proper cooking and baking results. After it is in its final location, place a level horizontally on any oven shelf and check the levelness front to back and side to side. Level the range by adjusting the leveling legs or by placing shims under the corners as needed.

One of the rear leveling legs will engage the Anti-Tip device (allow for some side to side adjustment). Allow a minimum clearance of 1/8 inch between the range and the leveling leg that is to be installed into the Anti-Tip device.



Read and follow this Safety Information carefully.

SAVE THESE INSTRUCTIONS

Using the surface burners.

Throughout this manual, features and appearance may vary from your model.

Lighting Instructions for Electric Ignition Models

The surface burners on some models are lighted by electric ignition, eliminating the need for standing pilot lights with constantly burning flames.

In case of a power failure, you can light the surface burners on your range with a match. Hold a lighted match to the burner, then turn the knob to the **LITE** position. **Use extreme caution when lighting burners this way.**

Surface burners in use when an electrical power failure occurs will continue to operate normally.

The electrode of the spark igniter is exposed. When one burner is turned to **LITE**, all the burners spark. Do not attempt to disassemble or clean around any burner while another burner is on. An electric shock may result, which could cause you to knock over hot cookware.

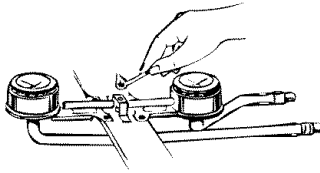

Lighting Instructions for Standing Pilot Models

The surface burners on these ranges have standing pilots that must be lit initially.

To light them:

- 1 Be sure surface burner control knobs are in the **OFF** position.
- 2 Lift the cooktop up or off (see the *Care and cleaning of the range* section).
- 3 Locate the 2 pilot ports and light each of them with a match.

- 4 If the pilots need adjusting, turn the adjusting screw located on the pilot filter.
- 5 Lower the cooktop. Your surface burners are now ready for use.
- 6 Observe lighted burners. Compare the flames to pictures in the *Before you call for service* section. If any flame is unsatisfactory, call for service.

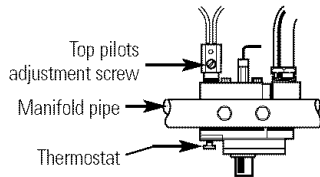

Top pilots adjustment screw controls the rate of gas to the top burner pilots.

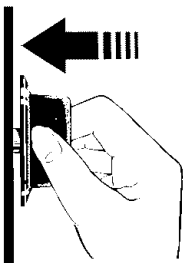

Surface Burner Controls

The knobs that turn the surface burners on and off are located on the control panel on the front of the range. The two knobs on the left control the left front and left rear burners. The two knobs on the right control the right front and right rear burners.

To Light a Surface Burner

- 1 Push the control knob in and turn it to **LITE** (**HI** on pilot models). On electric ignition models, you will hear a little **clicking** noise—the sound of the electric spark igniting the burner.
- 2 After the burner ignites, turn the knob to adjust the flame size.

After Lighting a Burner

- Check to be sure the burner you turned on is the one you want to use.
- Do not operate a burner for an extended period of time without cookware on the grate. The finish on the grate may chip without cookware to absorb the heat.
- Be sure the burners and grates are cool before you place your hand, a pot holder, cleaning cloths or other materials on them.

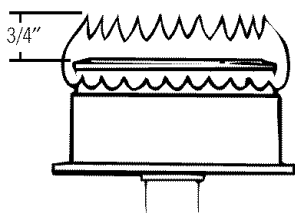

3/4" Flame height on HI setting
1/8" flame height in the low position

Air Adjustment

An air adjustment shutter for each surface burner regulates the flow of air to the flame.

When the right amount of air flows into the burner, the flame will be steady, relatively quiet and have approximately 3/4-inch sharp blue cones. This is usually the case with factory preset shutter settings.

With too much air, the flame will be unsteady, possibly won't burn all the way around, and will be noisy, sounding like a blowtorch.

With not enough air, you won't see any sharp blue cones in the flame, you may see yellow tips and soot may accumulate on pots and pans.

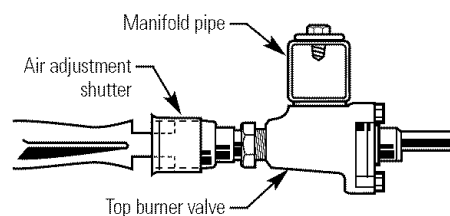

To adjust the flow of air to the burners, rotate the shutters to allow more or less air into the burner tubes as needed.

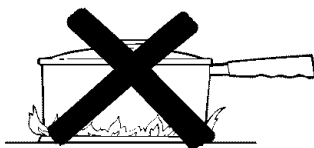

Never let the flame extend up the sides of the cookware.

How to Select Flame Size

Watch the flame, not the knob, as you reduce heat. The flame size on a gas burner should match the cookware you are using.

For safe handling of cookware, never let the flame extend up the sides of the cookware. Any flame larger than the bottom of the cookware is wasted and only serves to heat the handle.

Top of Range Cookware

Aluminum: Medium-weight cookware is recommended because it heats quickly and evenly. Most foods brown evenly in an aluminum skillet. Use saucepans with tight-fitting lids when cooking with minimum amounts of water.

Cast-iron: If heated slowly, most skillets will give satisfactory results.

Enamelware: Under some conditions, the enamel of some cookware may melt. Follow cookware manufacturer's recommendations for cooking methods.

Glass: There are 2 types of glass cookware—those for oven use only and those for top-of-range cooking (saucepans, coffee and teapots). Glass conducts heat very slowly.

Heatproof Glass Ceramic: Can be used for either surface or oven cooking. It conducts heat very slowly and cools very slowly. Check cookware manufacturer's directions to be sure it can be used on gas ranges.

Stainless Steel: This metal alone has poor heating properties and is usually combined with copper, aluminum or other metals for improved heat distribution. Combination metal skillets usually work satisfactorily if they are used with medium heat as the manufacturer recommends.

Using the oven.

Throughout this manual, features and appearance may vary from your model.

Lighting Instructions for Electric Ignition Models

The oven burner is lighted by electric ignition.

To light the burner, turn the **OVEN TEMP** knob to the desired temperature. The burner should light within 30-90 seconds.

After the oven reaches the selected temperature the oven burner cycles on and off to maintain the selected temperature.

Power Outage—Electric Ignition Models

A burner in use when an electrical power failure occurs will continue to operate normally. Your oven may be used during an electrical power outage by carefully following the steps below.

To light the oven pilot during an electrical power outage:

- 1 Be sure the **OVEN TEMP** knob is in the **OFF** position.
- 2 Open both the oven and broiler doors and wait 5 minutes to allow any pilot gas to dissipate.
- 3 Unplug the range from the wall outlet, turn off the circuit breaker, or remove the fuse to avoid accidental ignition of the oven if electrical power is restored while you are lighting the pilot.
- 4 Remove the broiler pan.

- 5 Locate the oven pilot assembly by looking into the broiler opening. The pilot is at the back of the broiler compartment, on the left side of the burner.

NOTE: The oven must be at room temperature before you should attempt to light the oven pilot manually.

- 6 Turn the **OVEN TEMP** knob to the desired temperature setting.
- 7 Light the pilot with a match and withdraw your arm immediately because the oven burner may light in as little as 20 seconds.
- 8 Replace the broiler pan and close the oven and broiler doors.

NOTE: It is necessary to light the pilot manually each time the oven is used during a power outage.

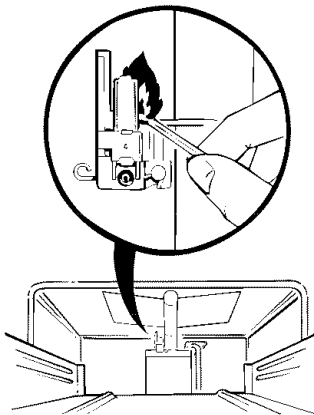

Lighting Instructions for Standing Pilot Models

The standing oven pilot must be lit initially.

To light the oven pilot:

- 1 Be sure the **OVEN TEMP** knob is in the **OFF** position.
- 2 Remove the oven bottom. See the *Care and cleaning of the range* section.
- 3 Find the oven pilot port at the back of the oven.
- 4 Using a long match or match holder, reach in and light the oven pilot.
- 5 Replace the oven bottom and close the door. Your oven and broiler are now ready for use.

■ To light the oven burner, turn the **OVEN TEMP** knob to the desired temperature. The burner should light within 60 seconds.

■ **Power failure?** An electrical power failure will not affect the standing oven pilot.

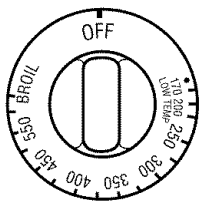

Oven Control

Your oven is controlled by an *OVEN TEMP* knob. It will normally take 30-90 seconds before the flame comes on.

After the oven reaches the selected temperature, the oven burner cycles—off completely, then on with a full flame—to maintain the selected temperature.

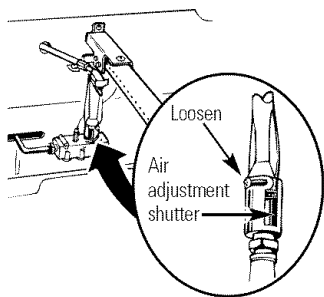

Air Adjustment

An air adjustment shutter for the oven burner regulates the flow of air to the flame.

You'll find the shutter against the back wall behind the broiler drawer. To reach it remove the oven bottom (see the *Care and cleaning of the range* section) and the burner baffle.

To adjust the flow of air, loosen the Phillips head screw and rotate the shutter to allow more or less air into the burner tube as needed.

When the right amount of air flows into the burner, the flame should be steady, with approximately 1/2 inch blue cones, and should not extend out over the baffle edges.

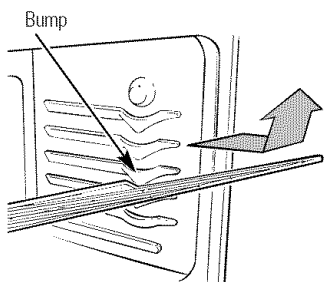

Oven Shelves

The shelves are designed with stop-locks so when placed correctly on the shelf supports, they will stop before coming completely out of the oven and will not tilt when you are removing food from them or placing food on them.

When placing cookware on a shelf, pull the shelf out to the bump on the shelf support. Place the cookware on the shelf, then slide the shelf back into the oven. This will eliminate reaching into the hot oven.

To remove the shelves from the oven, pull them toward you, tilt front end upward and pull them out.

To replace, place shelf on shelf support with stop-locks (curved extension of shelf) facing up and toward back of oven. Tilt up front and push shelf toward back of oven until it goes past the bump on the shelf support. Then lower front of shelf and push it all the way back.

Using the oven.

Throughout this manual, features and appearance may vary from your model.

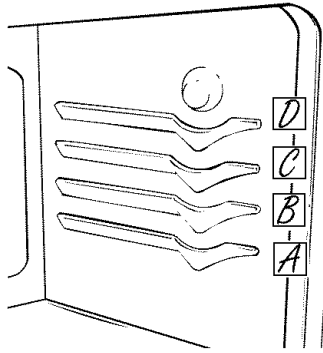

The oven has 4 shelf positions.

Oven Shelf Positions

The oven has four shelf supports—**A** (bottom), **B**, **C** and **D** (top).

Shelf positions for cooking are suggested in the *Using your oven for baking* and *Using your oven for roasting* sections.

Oven Vents

- The oven is vented through duct openings at the rear of the cooktop.
- Do not block the opening when cooking in the oven—it is important that the flow of hot air from the oven and fresh air to the oven burner be uninterrupted.
- The vent openings and nearby surfaces may become hot during baking and broiling. Do not touch them.
- Do not leave plastic items on the cooktop—they may melt if left too close to the vent.
- Handles of pots and pans on the cooktop may become hot if left too close to the vent.
- Metal items will become very hot if they are left on the cooktop and could cause burns.
- Do not leave any items on the cooktop. The hot air from the vent may ignite flammable items and will increase pressure in closed containers, which may cause them to burst.

The type of margarine will affect baking performance!

Most recipes for baking have been developed using high fat products such as butter or margarine (80% fat). If you decrease the fat, the recipe may not give the same results as with a higher fat product.

Recipe failure can result if cakes, pies, pastries, cookies or candies are made with low fat spreads. The lower the fat content of a spread product, the more noticeable these differences become.

Federal standards require products labeled “margarine” to contain at least 80% fat by weight. Low fat spreads, on the other hand, contain less fat and more water. The high moisture content of these spreads affects the texture and flavor of baked goods. For best results with your old favorite recipes, use margarine, butter or stick spreads containing at least 70% vegetable oil.

Using the oven for baking.

To avoid possible burns, place the shelves in the desired position before you turn the oven on.

How to Set the Oven For Baking

- 1 Close the oven door. Then turn the **OVEN TEMP** knob to the desired temperature.
- 2 Check the food for doneness at the minimum time on the recipe. Cook longer if necessary. Turn the **OVEN TEMP** knob to **OFF** and remove the food.

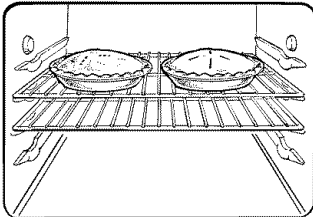

Place most foods in the middle of the oven.

Oven Shelves

Arrange the oven shelf or shelves in the desired locations while the oven is cool. The correct shelf position depends on the kind of food and the browning desired.

As a general rule, place most foods in the middle of the oven, on either the shelf position **B** or **C**. See the chart for suggested shelf positions.

Type of Food	Shelf Position
Angel food cake	A
Biscuits, muffins	B or C
Cookies or cupcakes	B or C
Brownies	B or C
Layer cakes	B or C
Bundt or pound cakes	A or B
Pies or pie shells	B or C
Frozen pies (on cookie sheet)	A
Casseroles	B or C

Preheating

Preheat the oven for 10 minutes if the recipe calls for it. Preheat means bringing the oven up to the specified temperature before putting the food in the oven.

To preheat, set the oven at the correct temperature—selecting a higher temperature does not shorten the preheat time.

Preheating is necessary for good results when baking cakes, cookies, pastry and breads. For most casseroles and roasts, preheating is not necessary.

Baking Pans

Use the proper baking pan. The type of finish on the pan determines the amount of browning that will occur.

- Glass baking dishes also absorb heat. When baking in glass baking dishes, lower the temperature by 25°F. and use the recommended cooking time in the recipe. This is not necessary when baking pies or casseroles.
- Dark, rough or dull pans absorb heat resulting in a browner, crisper crust. Use this type for pies.
- Shiny, bright and smooth pans reflect heat, resulting in a lighter, more delicate browning. Cakes and cookies require this type of pan.

Pan Placement

For even cooking and proper browning, there must be enough room for air circulation in the oven. Baking results will be better if baking pans are centered as much as possible rather than being placed to the front or to the back of the oven.

Pans should not touch each other or the walls of the oven. Allow 1 to 1½ inch space between pans as well as from the back of the oven, the door and the sides.

If you need to use two shelves, stagger the pans so one is not directly above the other.

Using the oven for baking.

Throughout this manual, features and appearance may vary from your model.

Cookies

For even cooking and proper browning, there must be enough room for air circulation in the oven.

Baking results will be better if baking pans are centered as much as possible rather than being placed to the front or to the back of the oven.

Pans should not touch each other or the walls of the oven. Allow 1 to 1½ inch space between pans as well as from the back of the oven, the door and the sides.

If you need to use two shelves, stagger the pans so one is not directly above the other.

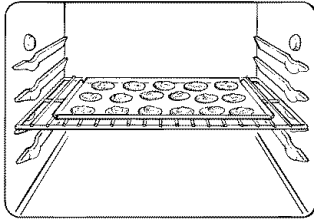

For best results, use only one cookie sheet in the oven at a time.

Oven Shelves

Flat cookie sheets (without sides) produce better-looking cookies. Cookies baked in a jelly roll pan (short sides all around) may have darker edges and pale or light browning may occur.

Do not use a cookie sheet so large that it touches the walls or the door of the oven. Never entirely cover a shelf with a large cookie sheet.

Pies

For best results, bake pies in dark, rough or dull pans to produce a browner, crisper crust.

Frozen pies in foil pans should be placed on an aluminum cookie sheet for baking since the shiny foil pan reflects heat away from the pie crust; the cookie sheet helps retain it.

Cakes

When baking cakes, warped or bent pans will cause uneven baking results and poorly shaped products.

A cake baked in a pan larger than the recipe recommends will usually be crisper, thinner and drier than it should be.

If baked in a pan smaller than recommended, it may be undercooked and batter may overflow.

Check the recipe to make sure the pan size used is the one recommended.

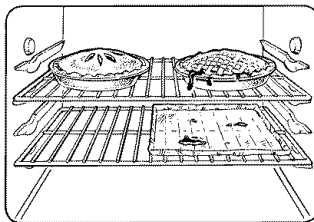

Aluminum Foil

Never entirely cover a shelf with aluminum foil. This will disturb the heat circulation and result in poor baking.

A smaller sheet of foil may be used to catch a spillover by placing it on a lower shelf several inches below the food.

Don't Peek

Set the timer for the estimated cooking time and do not open the door to look at your food. Most recipes provide minimum and maximum baking times such as "bake 30-40 minutes."

DO NOT open the door to check until the minimum time. Opening the oven door frequently during cooking allows heat to escape and makes baking times longer. Your baking results may also be affected.

Using the oven for roasting.

Roasting is cooking by dry heat. Tender meat or poultry can be roasted uncovered in your oven. Roasting temperatures, which should be low and steady, keep spattering to a minimum.

Roasting is really a baking procedure used for meats. Roasting is easy; just follow these directions:

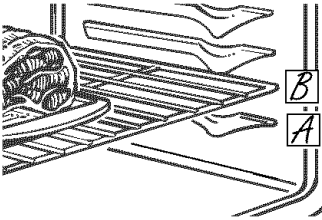

Place the shelf in the A or B position.

How to Set the Oven For Roasting

- 1 Place the shelf in the **A** or **B** position. No preheating is necessary.
- 2 Check the weight of the meat. Place it fat side up (or for poultry, breast-side-up) on a roasting rack in a shallow pan. The melting fat will baste the meat. Select a pan as close to the size of the meat as possible. Line the pan with aluminum foil when using the pan for marinating, cooking with fruits, cooking heavily cured meats, or basting food during cooking.
- 3 Turn the **OVEN TEMP** knob to the desired setting.
- 4 After roasting is complete, turn the **OVEN TEMP** knob to **OFF** and then remove the food from the oven.

Using the oven for broiling.

Broiling is cooking food by direct heat from above the food. Most fish and tender cuts of meat can be broiled. Follow these steps to keep spattering and smoking to a minimum.

Your range has a compartment below the oven for broiling. A specially designed broiler pan allows dripping fat to drain away from the food.

Both the oven and broiler compartment doors should be closed during broiling.

How to Set Your Oven for Broiling

- 1 You can change the distance of the food from the heat source by positioning the broiler pan in the broiler compartment—**A** (bottom of broiler compartment) or second position. Most broiling should be done in position **A**.
- 2 Preheat the broiler for best results.
- 3 If the meat has fat or gristle around the edge, cut vertical slashes through it about 2 inches apart, but don't cut into the meat. We recommend that you trim the fat to prevent excessive smoking, leaving a layer about 1/8 inch thick.
- 4 Close the oven and broiler compartment door.
- 5 Turn the **OVEN TEMP** knob to **BROIL**.
- 6 Turn most foods once during cooking. Time foods for about one-half the total cooking time, turn food, then continue to cook to preferred doneness.
- 7 Turn the **OVEN TEMP** knob to **OFF**. Remove the broiler pan from the broiler compartment and serve the food immediately. Leave the pan outside the range to cool.

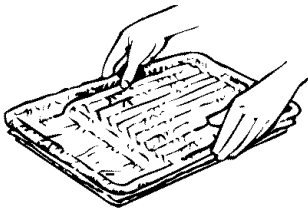

Use of Aluminum Foil

You can use aluminum foil to line your broiler pan. However, you must mold the foil tightly to the pan.

Broiling Guide

- The oven and broiler compartment doors must be closed during broiling.
- Always use the broiler pan that comes with your range.
- If desired, marinate meats or chicken before broiling. Or, brush with barbecue sauce the last 5 to 10 minutes.
- When arranging food on pan, do not let fatty edges hang over the sides. The fat drippings will soil the broiler compartment.
- Use tongs to turn the meat. Pierced meat loses juices.

Food	Amount or Thickness	Shelf Position	Time In Minutes		Comments
			First Side	Second Side	
Bacon	1/2 lb. (about 8 thin slices)	B	3½ min.	3 min.	Arrange in single layer
Ground Beef	1 lb. (4 patties) 1/2 to 3/4" thick	A	10–11 min.	4–5 min.	Space evenly.
Beef Steaks Medium	1 to 1½ lbs.	A	12 min.	5–6 min.	Steaks less than 1" thick cook through before browning. Pan frying is recommended.
Chicken	1 whole 2 to 2½ lbs., split lengthwise	A	30–35 min.	25–30 min.	Reduce time about 5 to 10 minutes per side for cut-up chicken. Brush each side with melted butter. Broil skin-side-down first.
Fish	1 lb. fillets 1/4 to 1/2" thick	B	5 min.	5 min.	Handle and turn very carefully. Brush with lemon butter before and during cooking, if desired. Preheat broiler to increase browning.

Care and cleaning of the range.

Be sure electrical power is off and all surfaces are cool before cleaning any part of the range.

Proper care and cleaning are important so your range will give you efficient and satisfactory service. Follow these directions carefully in caring for your range to assure safe and proper maintenance.

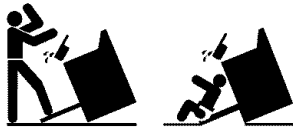

If your range is removed for cleaning, servicing or any reason, be sure the anti-tip device is re-engaged properly when the range is replaced. Failure to take this precaution could result in tipping of the range and cause injury.

How to Remove the Range for Cleaning and Servicing

Follow these steps to remove the range for servicing or cleaning hard to reach surfaces.

- 1 Shut off the gas supply to the range.
- 2 Disconnect the electrical supply to the range.
- 3 Disconnect the gas supply tubing to the range.
- 4 Slide the range forward to free the range foot from the Anti-Tip bracket. See the Installation Instructions for the location of the bracket.

- 5 Reverse these steps to re-install the range. If the gas line has been disconnected, check for gas leaks after re-connection. See the Installation Instructions for the gas lead test method.

NOTE: A trained technician should make the gas installation, disconnection and re-connection of the gas supply to the appliance.

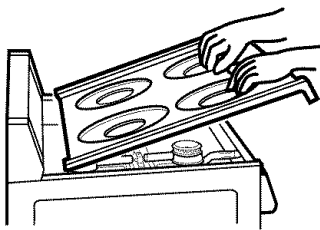

Lift-Up/Off Cooktop

Clean the area under the cooktop often. Built-up soil, especially grease, may catch on fire.

To make cleaning easier, the cooktop may be lifted up or off.

Be sure all burners are turned off before raising the cooktop. Then remove the grates.

Grasp the two front burner wells and lift the cooktop up or off. Be careful of the pilots when the cooktop is up.

After cleaning underneath the cooktop with hot, soapy water and a clean cloth, lower or replace the cooktop. Be careful not to pinch your fingers.



Burner Grates

Grates should be washed regularly and after spillovers. Wash them in hot, soapy water and rinse with clean water.

After cleaning, dry thoroughly by putting them in a warm oven for a few minutes.

Don't put the grates back on the range while they are wet. When replacing the grates, be sure they're positioned securely over the burners.

To get rid of burned-on food, place the grates in a covered container (or plastic bag) with 1/4 cup ammonia to loosen the soil. Then scrub with a soap-filled scouring pad if necessary.

Although they're durable, the grates will gradually lose their shine, regardless of the best care you can give them. This is due to their continual exposure to high temperatures.

Do not operate a burner for an extended period of time without cookware on the grate. The finish on the grate may chip without cookware to absorb the heat.

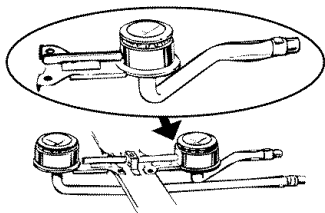

Burners

The holes in the surface burners of your range must be kept clean at all times for proper ignition and an even, unhampered flame.

You should clean the surface burners routinely, especially after bad spillovers, which could clog these holes. Wipe off the surface burners. If heavy spillover occurs, remove the surface burners from the range. The burners lift out for cleaning. Lift up the cooktop and then lift out the surface burners.

NOTE: A screw holds each of the burners in place to keep them from wobbling around during shipment. Remove and discard the shipping screw. Tilt the burner to one side at the end closest to the igniter. This disengages it from the gas valves at the front of the range. It lifts out easily.

To remove burned-on food, soak the surface burner in a solution of mild liquid detergent and hot water. Soak the surface burner for 20 to 30 minutes. For more stubborn stains, use a cleanser like Soft Scrub® brand or Bon Ami® brand. Rinse well to remove any traces of the cleanser that might clog the surface burner openings. Do not use steel wool because it will clog the surface burner openings and scratch the surface burners. If the holes become clogged, clean them with a small pin or sewing needle.

Before putting the surface burner back, shake out excess water and then dry it thoroughly by setting it in a warm oven for 30 minutes. Then place it back in the range, making sure it is properly seated and level.

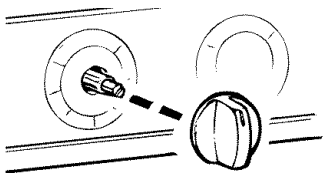

Control Panel and Knobs

It's a good idea to wipe the control panel after each use of the oven. Clean with mild soap and water or vinegar and water, rinse with clean water and polish dry with a soft cloth.

Do not use abrasive cleansers, strong liquid cleaners, plastic scouring pads or oven cleaners on the control panel—they will damage the finish. A 50/50 solution of vinegar and hot water works well.

The control knobs may be removed for easier cleaning.

To remove the knob, pull it straight off the stem. Wash the knobs in soap and water or a vinegar and hot water solution but do not soak.



Oven Shelves

The shelves can be cleaned by hand using soap and water or with an abrasive cleaner. After cleaning, rinse the shelves with clean water and dry.

To remove heavy, burned-on soil, you may use scouring pads. After scrubbing, wash with soapy water, rinse and dry.

Metal Parts

Do not use steel wool, abrasives, ammonia or commercial oven cleaners.

To safely clean surfaces: wash, rinse and then dry with a soft cloth.

Care and cleaning of the range.

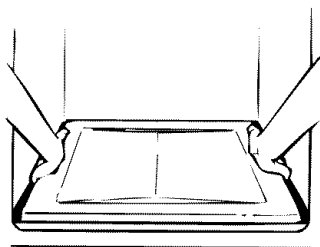

Removable Oven Bottom

First remove the shelves from the oven. The oven bottom lifts from the rear. Grasp each side of the oven bottom and lift upward from the rear until the bottom is clear—lift it to remove from the front.

NOTE: If the oven bottom is replaced incorrectly, it may warp and cause undesirable baking results.

Cleaning the Oven Bottom

The oven bottom has a porcelain enamel finish.

To make cleaning easier, protect the oven bottom from excessive spillovers. This is particularly important when baking a fruit pie or other foods with high acid content. Hot fruit fillings or foods that are acidic in content, such as tomatoes or sauerkraut, and sauces with vinegar or lemon juice, may cause pitting and damage to the porcelain enamel surface.

To protect the oven bottom surface, place a piece of aluminum foil slightly larger than the baking dish on the shelf below to catch any boilovers. It should not completely cover the shelf as this would cause uneven heat in the oven. Aluminum foil should not be placed on the oven bottom.

If a spillover does occur on the oven bottom, allow the oven to cool first. You can clean the bottom with soap and water, a mild abrasive cleanser, soap-filled steel wool pads or an oven cleaner following package directions.

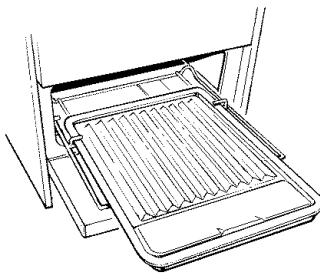

Broiler Drawer

The broiler pan is held in place by a wire broiler rack.

To open the broiler:

- 1 Gently lift up and pull forward on the drop down broiler door.
- 2 Pull the broiler pan forward. It will reach a temporary stop position.
- 3 Continue to pull forward and the broiler pan will pull out to expose the entire broiler grill surface.
- 4 Remove the broiler pan from the broiler rack by lifting up on the front of the broiler pan so it will clear the wire rack. Then pull forward slightly and use both hands to lift the pan free of the rack.

To return the pan to the broiler rack:

- 1 Pull the wire rack out to the stop position.
- 2 Insert the pan into the recessed section of the broiler rack.
- 3 Slide the pan in place under the pan retainers. Push the pan to the rear of the broiler compartment.
- 4 Close the broiler door.

Broiler Pan

After broiling, remove the broiler pan and carefully pour out the grease in the pan into a proper container.

If food has burned on, sprinkle the pan with detergent while hot and cover with wet paper towels or a dishcloth. Burned-on foods will soak loose while the meal is being served.

Wash; scour if necessary. Rinse and dry. The broiler pan may also be cleaned in a dishwasher. Do not store a soiled broiler pan anywhere in the range.

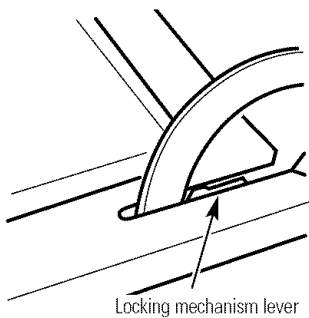

Lift-Off Oven Door (on some models)

The oven door is removable (on some models) but it is heavy. You may need help removing and replacing the door.

To remove the door:

- 1 Open the door to the full open position.
- 2 Raise the locking mechanism by applying force to the locking mechanism lever.
- 3 Close the door until it stops against the locking mechanism.
- 4 Grasp firmly on each side and lift the door straight up and off the hinges.

To replace the door:

- 1 Position the slots in the bottom of the door squarely over the hinges. Then lower the door slowly and evenly over both hinges at the same time.
- 2 Open the door to the full open position and press the locking mechanism back into its original position.

DO NOT ATTEMPT TO CLOSE THE DOOR UNTIL THIS STEP IS COMPLETE. THE HINGE OR DOOR COULD BE DAMAGED.

TO CLEAN THE DOOR:

Inside of door:

- Soap and water will normally do the job. Heavy spattering or spillovers may require cleaning with a mild abrasive cleaner. Soapy, wet metal pads may also be used. Do not allow food spills with a high sugar or acid content (such as milk, tomatoes, sauerkraut, fruit juices or pie filling) to remain on the surface. They may cause a dull spot even after cleaning.
- If necessary, you may use an oven cleaner. Follow package directions.

Outside of door:

- Use soap and water to thoroughly clean the top, sides and front of the oven. Rinse well.
- Spillage of marinades, fruit juices, tomato sauces and basting materials containing acids may cause discoloration and should be wiped up immediately. When surface is cool, clean and rinse.
- Do not use oven cleaners, cleansing powders or harsh abrasives on the outside of the door.

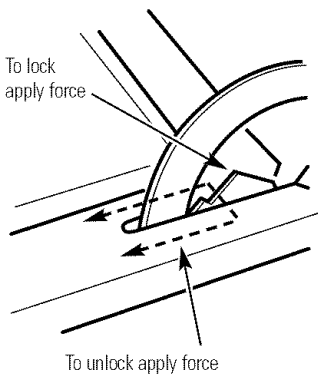

Safety Instructions
Operating Instructions
Care and Cleaning
Installation Instructions
Troubleshooting Tips
Customer Service

Care and cleaning of the range.



Porcelain Oven Interior

With proper care, the porcelain enamel finish on the inside of the oven will stay new-looking for years.

Let the range cool before cleaning.

We recommend that you wear rubber gloves when cleaning the range.

Soap and water will normally do the job. Heavy spattering or spillovers may require cleaning with a mild abrasive cleaner. Soapy, wet metal pads may also be used. Do not allow food spills with a high sugar or acid content (such as tomatoes, sauerkraut, fruit juices or pie filling) to remain on the surface. They may cause a dull spot even after cleaning.

Household ammonia may make the cleaning job easier. Place 1/2 cup in a shallow glass or pottery container in a cold oven overnight. The ammonia fumes will help loosen the burned-on grease and food.

If necessary, you may use an oven cleaner. Follow package directions.

Cautions about using spray-on oven cleaners:

- Do not spray on the electrical controls and switches because it could cause a short circuit and result in sparking or fire.
- Do not allow a film from the cleaner to build up on the temperature sensor—it could cause the oven to heat improperly. (The sensor is located at the top of the oven.) Carefully wipe the sensor clean after each oven cleaning, being careful not to move the sensor as a change in its position could affect how the oven bakes.
- Do not spray any oven cleaner on the outside of the oven door, handles or any exterior surface of the oven, wood or painted surfaces. The cleaner can damage these surfaces.

Installation of the range.

Read these instructions completely and carefully.



Important!

Remove all packing material and literature from oven before connecting gas and electrical supply to range.



Before You Begin

Read these instructions completely and carefully.

IMPORTANT: Save these instructions for the local electrical inspector's use.

INSTALLER: Leave these instructions with the appliance after installation is completed.

CONSUMER: Keep this Owner's Manual and the Installation Instructions for future use.

This appliance must be properly grounded.

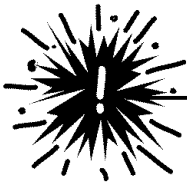

For Your Safety

If you smell gas:

- 1 Open windows.
- 2 Don't touch electrical switches.
- 3 Extinguish any open flame.
- 4 Immediately call your gas supplier.

Do not store or use combustible materials, gasoline or other flammable vapors and liquids in the vicinity of this or any other appliance.



WARNING!

■ **Improper installation, adjustment, alteration, service or maintenance can cause injury or property damage. Refer to this manual. For assistance or additional information, consult a qualified installer, service agency, manufacturer (dealer) or the gas supplier.**

■ **Flexible connectors—If the range is connected with a flexible connector, use caution when moving it away from the wall. Flexible connectors are not intended for repeated bending. Do not allow cleaners to get on them. Never reuse old flexible connectors; this can cause gas leaks and personal injury. Always use NEW flexible connectors when installing a gas appliance. They must comply with ANSI Z21.24, latest edition.**

Installation of the range.

Read these instructions completely and carefully.



Dimensions and Clearances

Provide adequate clearances between the range and adjacent combustible surfaces.

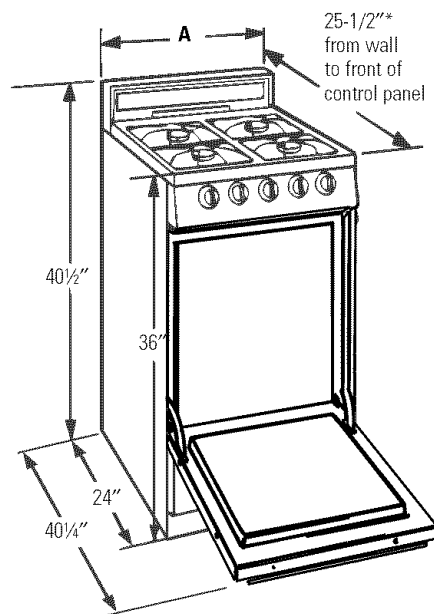

*Depth including handle: 25-9/16."
Depth to front of control knobs: 26-1/8."

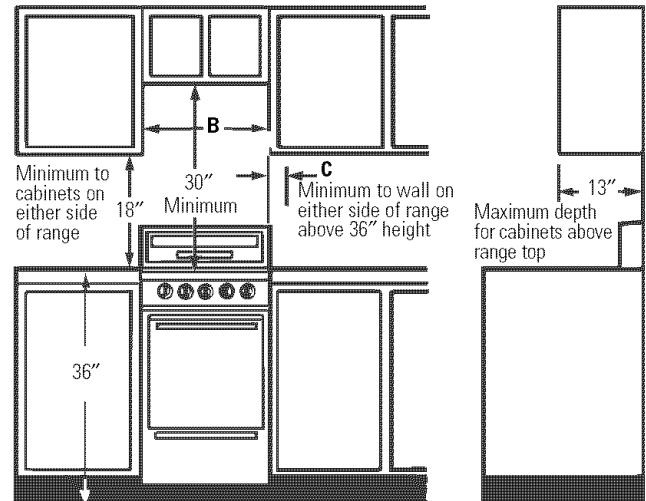

0" clearance below cooking top and at rear of range

Models	A	B	C
20" Wide	20"	20 ³ / ₈ "	2"
24" Wide	24"	24 ³ / ₈ "	0"



Important Safety Instructions

Installation of this range must conform with local codes, or in the absence of local codes, with the National Fuel Gas Code, ANSI Z223.1, latest edition. In Canada, installation must conform with the current Natural Gas Installation Code, CAN/CGA-B149.1 or the current Propane Installation Code, CAN/CGA-B149.2, and with local codes where applicable.

This range has been design-certified by the American Gas Association according to ANSI Z21.1, latest edition and Canadian Gas Association according to CAN/CGA-1.1 latest edition. As with any appliance using gas and generating heat, there are certain safety precautions you should follow. You will find these precautions in the Important Safety Instructions in the front of this guide. Read them carefully.

- A range should **NOT** be installed directly over kitchen carpeting unless an insulating pad of 1/4-inch thick piece of plywood is placed between the range and carpet.

- Be sure your range is properly installed by a qualified installer or service technician.
- This range must be electrically grounded in accordance with local codes, or in their absence, with the National Electrical Code ANSI/NFPA No. 70, latest edition and Canadian Gas Association according to CAN/CGA-1.1 latest edition. See Electrical Connection Information.
- Before installing the range in an area covered with linoleum or any other synthetic floor covering, make sure the floor covering can withstand heat at least 90°F. above room temperature without shrinking, warping or discoloring.
- Make sure the wall coverings around the range can withstand the heat generated by the range.
- Make sure all controls remain in the **OFF** position when the range is not in use.

Read these instructions completely and carefully.



Tools You Will Need

For leveling legs:

- Channel lock pliers

For gas supply connection:

- Pipe wrench

For conversion from Natural to LP gas:

- 1/2-inch open-end wrench

For burner flame adjustment:

- Phillips head and blade-type screwdrivers



Additional Materials You May Need

- Gas line shut-off valve.

- Pipe joint sealant that resists action of LP gas.

- 1/2-inch pipe nipple.

For Rigid Connection:

- Pipe fittings as required.

For Flexible Connection:

- Flexible metal appliance connector (same 3/4-inch or 1/2-inch I.D. as gas supply line).

- Flare union adapter line (1/2-inch NPT x 3/4-inch or 1/2-inch I.D.).

Step 1

Installing the Backguard

- 1 Remove the cooktop.
- 2 Place the backguard on top of the end panels at the rear of the range.
- 3 Connect the “disconnect plug” (for power to the backguard from the range).
- 4 Insert the machine screws through the lower inside flange of the end caps and the end panels. Secure with the hex nuts provided.
- 5 Insert the machine screws through the elongated holes at the bottom of the backguard and side flange of the burner box. Secure with the hex nuts provided.
- 6 Attach the lower edge of the backguard to the vent outlet with 2 sheet metal screws.

Safety Instructions

Operating Instructions

Care and Cleaning

Installation Instructions

Troubleshooting Tips

Customer Service

Installation of the range.

Read these instructions completely and carefully.

Step 2 Range Location

Do not set the range over holes in the floor or other locations where it may be subject to strong drafts. Any opening in the wall behind the range and in the floor under the range should be sealed. Make sure the flow of combustion or ventilation air is not obstructed.

Recommended gas and electric supply location

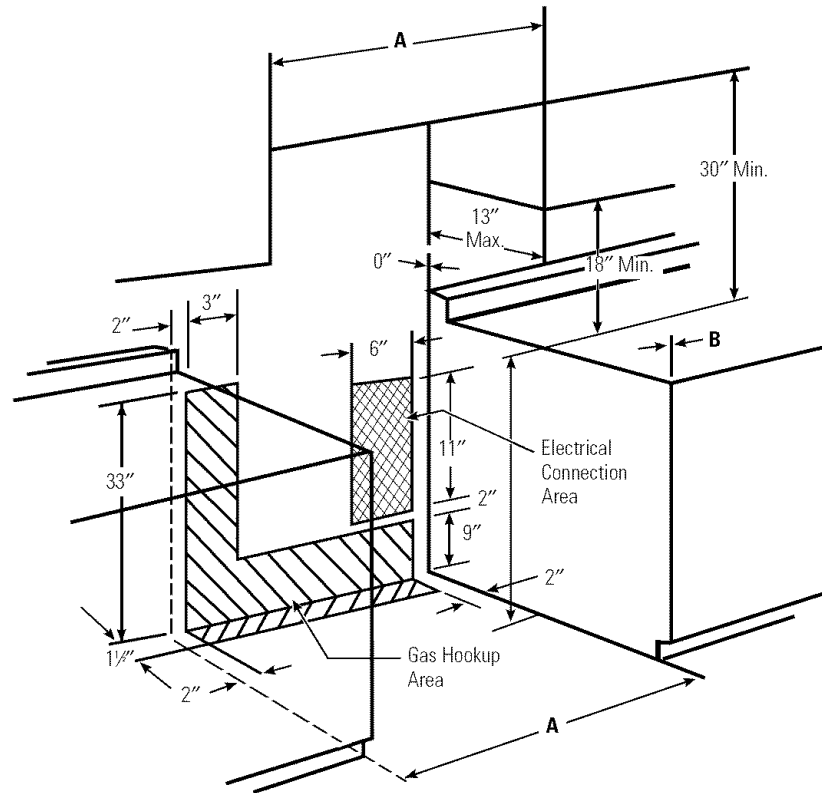

Check local codes before making connections.

Models	A	B
20" Wide	20 ³ / ₈ "	2"
24" Wide	24 ³ / ₈ "	0"

Read these instructions completely and carefully.



⚠ WARNING!

Anti-Tip Bracket



- ALL RANGES CAN TIP
- INJURY COULD RESULT
- INSTALL ANTI-TIP DEVICE PACKED WITH RANGE



- SEE INSTRUCTIONS



Tools You Will Need

- Phillips head screwdriver
- 1 $\frac{3}{8}$ " or adjustable wrench
- Flat blade screwdriver

Step

3

Anti-Tip Bracket Installation Instructions

Anti-tip bracket attaches to the floor to hold either rear range leg. When fastening to the floor, be sure that the screw does not penetrate electrical wiring or plumbing. If you cannot be sure of this, use a shorter screw that will not penetrate through the flooring.

- 1 Decide whether the anti-tip bracket will be installed on the right or left side of the range location.
- 2 If the bracket side of the range is next to a cabinet, place the bracket against back wall and cabinet.

If there is no adjacent cabinet, determine where the location of the range side (painted outside panel) will be. Place the bracket with its outside edge at this location and against the back wall.

Outside edge of bracket should be flush with the outside of the range

Adjacent cabinet or final location of range side panel

Wall behind range

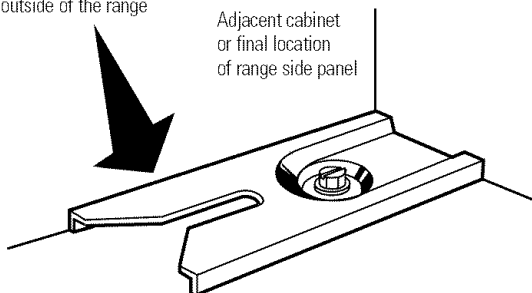

- 3 Screw the bracket securely to the floor with the screw provided. The screw is self-drilling in wood, plywood, particle and chip board, and most metal framing. If attaching to masonry, you can buy suitable screws and/or anchors at hardware stores. Use a masonry drill to drill the required holes.

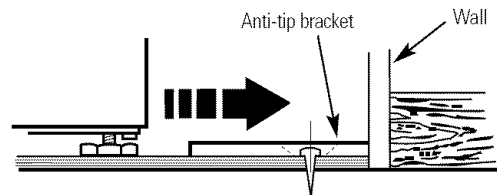

- 4 Using the wrench, back out the four range legs at least two turns. Level the range. See the *Protect Your Floor* and *Leveling the Range* information in the *Installation the range* section of this manual for leveling information.

- 5 Slide the range into place.

Installation of the range.

Read these instructions completely and carefully.

Step 4

Convert Burner Orifices and Pressure Regulator (if necessary)

1 Converting Burner Orifices to LP Gas:

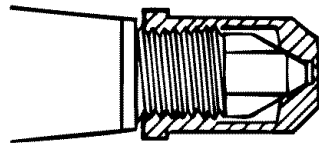

LP gas setting

Tighten the orifice hoods for the surface burners and oven burner approximately two complete turns to the closed position and adjust top pilots, if equipped. The gas pressure regulator must be converted to the LP gas setting so that it will provide a pressure of 10 inches water column to the range manifold.

2 Converting Burner Orifices to Natural Gas: (only if range has been operated previously on LP gas)

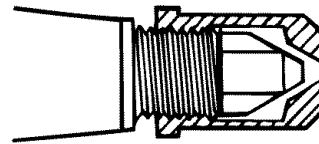

NAT. gas setting

Unscrew the orifice hoods for all burners (top and oven) approximately two complete turns, until the flame on the burner does not increase in length. Adjust the top pilots (if equipped). The gas pressure regulator must be set to the natural gas setting so that it will provide a pressure of 4 inches of water column in the range manifold.

3 Regulator Conversion:

All ranges are equipped with a gas pressure regulator for controlling and maintaining a uniform gas pressure in the gas manifold of the range. The burner orifices are sized for the gas pressure delivered by the regulator supplied. The pressure regulator must not be removed. To convert the regulator from one gas to another, refer to the following illustration that applies:

Harper-Wyman Regulator:

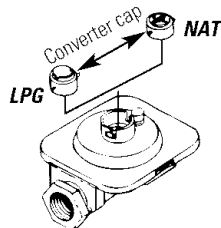

For a Harper-Wyman regulator, remove converter cap by inserting a coin into slot in top and twisting. Turn cap over and re-install.

SCP Regulator:

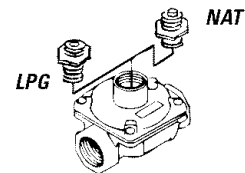

On the SCP regulator, unscrew the converter using a 5/8" wrench. Turn the cap over and reinstall.

NOTE: What you read on the converter cap or plunger is the type of gas for which the regulator is set. If yours reads NAT, the regulator is set for natural gas. If yours reads LP, the regulator is set for LP.

■ For proper operation, the maximum inlet pressure to the regulator must be no more than 14 inches of water column pressure. For checking the regulator, the inlet pressure must be at least 1-inch of water column (3.4 KPA) greater than the regulator output setting. If the regulator is set for 4 inches of water column pressure, the inlet pressure must be at least 5 inches. If the regulator is set for 10 inches, the inlet pressure must be at least 11 inches.

■ The gas supply line to the range should be 1/2 inch or 3/4 inch pipe.

For standing pilot models, make the necessary oven pilot adjustment (see directions in the *If Range Has Standing Pilots—Light and Adjust Surface Burner Pilots* section). Also burner air shutter adjustments may be necessary on all models to complete conversion (see the *Surface Burner Air Shutter Adjustment* section).

Read these instructions completely and carefully.

Step 5 Connect the Range to Gas

The house piping and connector used to connect the range to the main gas supply must be clean, free of metal shavings, rust, dirt or liquids (oil or water). Contaminants in the supply lines can work their way into the range manifold and cause failure of gas valves or controls and clog burners or pilot orifices.

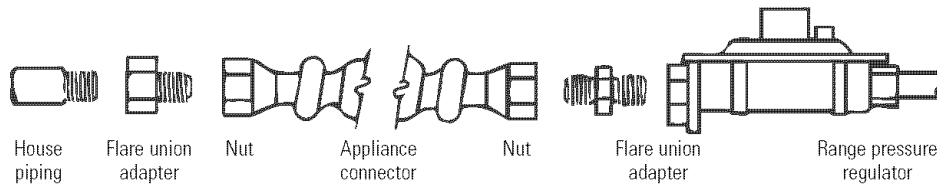

- 1 If the range is to be connected to house piping with flexible or semi-rigid metal appliance connector, connector nuts **MUST NOT** be connected directly to pipe threads.
- 2 The appliance connector must be installed by using the proper flare union adapters with the connector. Cutoff valve, appliance connector and adapters are not supplied with the range. (Because solid pipe restricts moving the range, we recommend use of A.G.A. certified flexible tubing.) In Canada, flexible connectors must be single wall metal connectors no longer than 6 feet in length.
- 3 Install a manual shutoff valve in the gas line in an easily accessible location outside of the range. Be sure you know how and where to shut off the gas supply to the range.
- 4 Check for leaks. After connecting the range to gas, check the system for leaks with a liquid leak detector at all joints and connections.
- 5 Tighten all connections as necessary to prevent gas leakage in the range or supply line.
CAUTION: Do not use a flame to check for gas leaks.
- 6 Check alignment of valves after connecting the range to the gas supply to be sure the manifold pipe has not been moved. A misalignment could cause the valve knob stem to rub on the control panel, resulting in a gas leak at the valve.

Disconnect the range and its individual shut-off valve from the gas supply piping system during any pressure testing of the system at test pressures greater than 1/2 psig.

Isolate the range from the gas supply piping system by closing its individual manual shut-off valve during any pressure testing of the gas supply piping system at test pressures equal to or less than 1/2 psig.



Checking Manifold Gas Pressure

If it should be necessary to check the manifold gas pressure, connect manometer (water gauge) or other pressure device to the top burner orifice farthest from the manifold inlet and turn burner valve on.

For an accurate pressure check have at least 2 other top burners burning. Be sure the gas supply inlet pressure is at least one inch above specified range manifold pressure.

The gas supply pressure should never be over 14 inches W.C. When properly adjusted for Natural Gas the W.C. pressure is 4 inches; for LP Gas the W.C. pressure is 10 inches. The serial plate, located under the main top in the burner box area, indicates for which type of gas your range was factory adjusted.

Installation of the range.

Read these instructions completely and carefully.

Step 6 To Make Electrical Connection (if range has electric ignition)

CAUTION—FOR PERSONAL SAFETY: DO NOT USE AN EXTENSION CORD WITH THIS APPLIANCE.

■ This appliance must be supplied with the proper voltage and frequency, and connected to an individual, properly grounded and polarized branch circuit, protected by a circuit breaker or time-delay fuse, as noted on the rating plate.

■ Wiring must conform to National Electric Codes or the prevailing local code for a range of this kilowatt rating. (See the rating plate under the cooktop for this information.)

■ If the electric supply provided does not meet the above specifications, call a licensed electrician.



⚠ WARNING!

Electrical Grounding Instructions

This appliance is equipped with a three prong grounding plug for your protection against shock hazard and should be plugged directly into a properly grounded receptacle. Do not cut or remove the grounding prong from this plug.

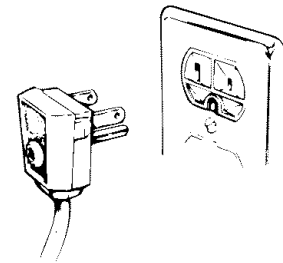

INSURE PROPER GROUND EXISTS BEFORE USE.

Step 7 Light and Adjust Surface Burner Pilots (if range has standing pilots)

- 1 Purge all air from supply system by turning one top burner valve fully **ON** for 15 seconds.
- 2 Turn valve **OFF** and light pilot burners. Adjust pilot flames using the adjusting screw on the back of the thermostat, so that each flame is approximately 1/4-inch in height.
- 3 To light any top burner, push and turn burner knob to the **LITE** position.
- 4 When burner has ignited, rotate knob to desired flame setting.

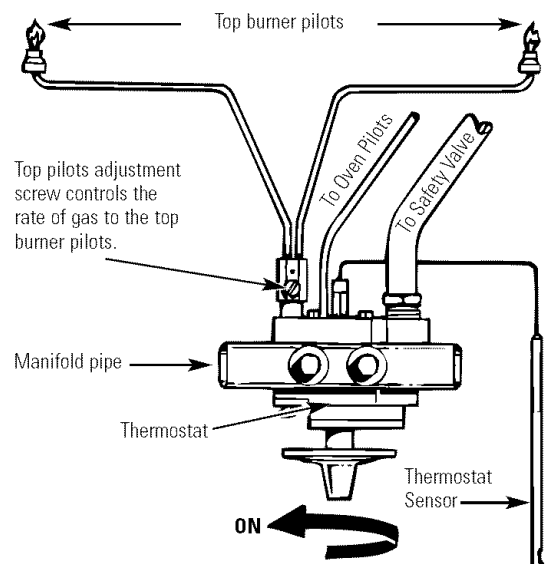

Read these instructions completely and carefully.

Step 8 If Range Has Electric Ignition

There are separate ignition devices for the left and right hand surface burners. Both of these ignitors are **ON** when any knob is turned to the **LITE** setting. The ignitors will **spark** as long as any of the top burner knobs are at the **LITE** setting.

In the event of an electrical power failure, the top burners can still be used. To light a burner, hold a lighted kitchen match adjacent to the top burner to be used and turn valve knob to **LITE**. **USE EXTREME CAUTION.**

Step 9 Oven Pilot Adjustment

On pilot models remove thermostat knob.

Check position of pilot gas selector to make sure selector is turned to the correct position for the type of gas that is to be used. To change to **LP**, insert small blade screwdriver in slot and turn fully clockwise so that indicator points to **LP**. To change to **NAT**, turn fully counterclockwise so that indicator points to **NAT**.

- If desired, the gas to the oven pilot can be turned off by turning the selector so the pointer is at the **OFF** position, midway between the **LP** and **NAT** settings. (Thermostat on your range may not appear exactly as shown in diagram.)
- On electric ignition models the gas to the oven burner can be turned off. A manual shut-off valve is provided on manifold pipe.

Oven pilot selector key switches from LP to NAT (vice versa).

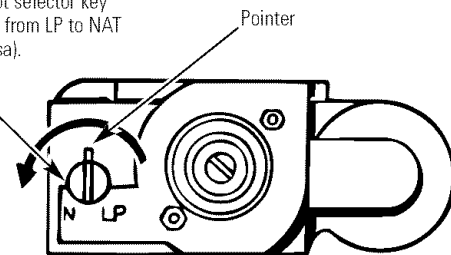

Front view

Step 10 Oven Operation

- 1 With the oven thermostat dial in the **OFF** position, light standing pilot on oven burner pilot assembly. On electric ignition models do not attempt to manually light the oven pilot.
- 2 Turn the thermostat dial to any temperature setting. The oven pilot flame will enlarge and engulf the mercury bulb. After approximately 30–45 seconds the main burner will come on.
- 3 The oven can be used during periods of power outage. (See the *Using the surface units* section.)

With control knob in OFF position, light standing pilot. Flame should appear as shown.

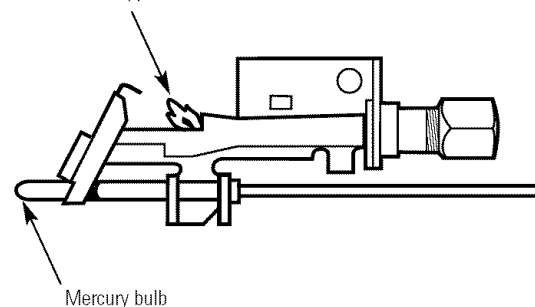

Installation of the range.

Read these instructions completely and carefully.

Step 11 Surface Burner Air Shutter Adjustment

The approximate height of the flame at the high or full **ON** position is a distinct inner blue cone of at least 3/4 inch. Turn valve knob counterclockwise 90° to the full **ON** position and adjust air shutter as follows:

- A** To correct a yellow flame—Increase size of air shutter opening.
- B** To correct a lifting, but distinct, blue flame—Decrease size of air shutter opening.

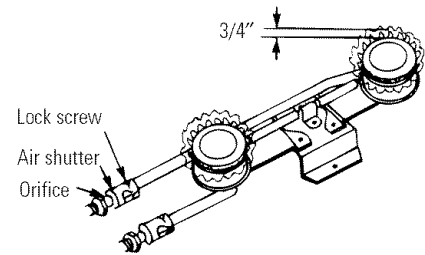

Step 12 Oven Burner Air Shutter Adjustment

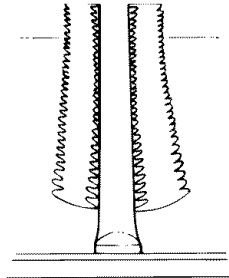

The oven burner flame should be a clean, blue flame with distinct inner cones approximately 1/2 inch long. A soft, lazy flame with indistinct cones means too much gas or not enough air. A noisy lifting flame means too much air.

If adjustments are necessary:

- 1** First loosen the lock screw located at the top of the air shutter, then rotate the air shutter to the correct setting, and retighten screw.
- 2** Oven burner flame can be checked as follows (without burner baffle in place):
 - A** To correct a yellow flame—Increase size of air shutter opening.
 - B** To correct a lifting, but distinct, blue flame—Decrease size of air shutter opening.

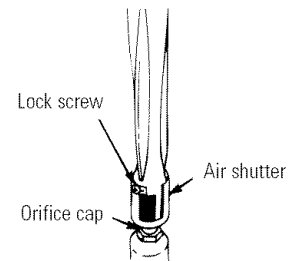

- 3** The air shutter should be set approximately 2/3 open for natural gas, and approximately full open on LP gas.
- 4** The oven burner air shutter adjustment is the same on ranges with a gas pilot or electric ignition.
- 5** Repeat steps 1 through 3 for the broil burner, if equipped, to properly adjust the broil burner flame.

Read these instructions completely and carefully.



When All Hookups Are Complete

- 1 Make sure all controls are left in the OFF position.
- 2 Make sure the flow of combustion and ventilation air to the range is unobstructed.

Mobile Home Installation:

Be sure the installation of this range in a manufactured or mobile home conforms with the Manufactured Home Construction and Safety Title 24 CFR, Part 3280 [formerly the Federal Standard for Mobile Home Construction and Safety Title 24, H.U.D. (Part 280)] or when such standards are not applicable, the Standard for Manufactured Home Installations 1984 (Manufactured Home Sites Communities and Set-Ups), ANSI A225.1-latest edition, or with local codes. In Canada, mobile home installation must be in accordance with the current CAN/CSA Z240/MH Mobile Home Installation Code.

Model and Serial Number Location:

The serial plate for your range is located under the cooktop on the right side of the burner box. In addition to the model and serial numbers, it tells you the ratings of the burners and type of fuel and pressure for which the range was adjusted when it left the factory.

When ordering parts, always include the model number and serial number to ensure proper replacement parts. Parts may be obtained through General Electric/Hotpoint Factory Service Centers or General Electric/Hotpoint authorized Customer Care® servicers.

Before You Call For Service...



Troubleshooting Tips
Save time and money! Review the chart on this page first and you may not need to call for service.

<i>Problem</i>	<i>Possible Causes</i>	<i>What To Do</i>
<i>Top burners do not light or do not burn evenly</i>	The pilots are not lit. (on standing pilot models)	<ul style="list-style-type: none"> On models with standing pilots, lift the cooktop and hold a lit match next to the pilot opening between the front and rear burners.
	Plug on range is not completely inserted in the electrical outlet.	<ul style="list-style-type: none"> On models with electric ignition, make sure electrical plug is plugged into a live, properly grounded outlet.
	Burner holes on the side or around the top of the burner may be clogged.	<ul style="list-style-type: none"> Remove the burners and clean them with a safety pin or paper clip. Make sure you do not enlarge the holes.
<i>Burners have yellow or yellow-tipped flames</i>	The combustion quality of burner flames needs to be determined visually.	<ul style="list-style-type: none"> Remove the burners and reinstall them properly.
		<ul style="list-style-type: none"> Use the illustrations below to determine if your burner flames are normal. If burner flames look like A, call for service. Normal burner flames should look like B or C, depending on the type of gas you use. With LP gas, some yellow tipping on outer cones is normal.
		<p>A–Yellow flames Call for service B–Yellow tips on outer cones Normal for LP gas C–Soft blue flames Normal for natural gas</p>
<i>Burner flames very large or yellow</i>	LP gas is improperly connected.	<ul style="list-style-type: none"> Check all steps in the <i>Installation of the range</i> section.
<i>Oven will not work</i>	The thermostat capillary bulb must be clean and unobstructed.	<ul style="list-style-type: none"> Make sure the thermostat capillary bulb (located in the upper portion of the oven) is in the correct position, not touching oven sides and not coated with anything.
	The oven vent is blocked.	<ul style="list-style-type: none"> The oven vent, on the back of the range, must be unobstructed.
	Oven control improperly set.	<ul style="list-style-type: none"> See the <i>Using the oven</i> sections.
	Incorrect cookware or cookware of improper size being used.	<ul style="list-style-type: none"> See the <i>Using the oven for baking or roasting</i> section.
	Oven bottom not securely seated in position.	<ul style="list-style-type: none"> See the <i>Care and cleaning of the range</i> section.
<i>Strong odor</i>	Improper air/gas ratio in the oven.	<ul style="list-style-type: none"> Adjust oven burner air shutter. See the <i>Installation of the range</i> section.
	This is temporary.	<ul style="list-style-type: none"> An odor from the insulation around the oven liner is normal for the first few times the oven is used.

Gas Range Warranty.



All warranty service provided by our Factory Service Centers or an authorized Customer Care® technician. For service, call 800-GE-CARES.

For The Period Of: We Will Replace, At No Charge To You:

One Year
From the date of the original purchase

Any part of the range which fails due to a defect in materials or workmanship. During this **full one-year warranty**, we will also provide, **free of charge**, all labor and in-home service to replace the defective part.

What is Not Covered:

- Service trips to your home to teach you how to use the product.
- Replacement of house fuses or resetting of circuit breakers.
- Improper installation.
- Damage to the product caused by accident, fire, floods or acts of God.
- Failure of the product if it is abused, misused, or used for other than the intended purpose or used commercially.
- Incidental or consequential damage to personal property caused by possible defects with this appliance.

This warranty is extended to the original purchaser and any succeeding owner for products purchased for home use within the USA. In Alaska, the warranty excludes the cost of shipping or service calls to your home.

Some states do not allow the exclusion or limitation of incidental or consequential damages. This warranty gives you specific legal rights, and you may also have other rights which vary from state to state. To know what your legal rights are, consult your local or state consumer affairs office or your state's Attorney General.

Warrantor: General Electric Company, Louisville, KY 40225

Safety Instructions

Operating Instructions

Care and Cleaning

Installation Instructions

Troubleshooting Tips

Customer Service

Consumer Support.



GE Appliances Website

www.GEAppliances.com

Have a question or need assistance with your appliance? Try the GE Appliances Website 24 hours a day, any day of the year! For greater convenience and faster service, you can now download Owner's Manuals, order parts, catalogs, or even schedule service on-line. You can also "Ask Our Team of Experts™" your questions, and so much more...

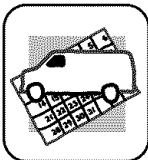

Schedule Service

www.GEAppliances.com

Expert GE repair service is only one step away from your door. Get on-line and schedule your service at your convenience 24 hours any day of the year! Or call 800-GE-CARES (800-432-2737) during normal business hours.

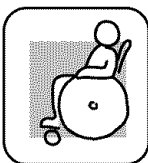

Real Life Design Studio

www.GEAppliances.com

GE supports the Universal Design concept—products, services and environments that can be used by people of all ages, sizes and capabilities. We recognize the need to design for a wide range of physical and mental abilities and impairments. For details of GE's Universal Design applications, including kitchen design ideas for people with disabilities, check out our Website today. For the hearing impaired, please call 800-TDD-GEAC (800-833-4322).



Extended Warranties

www.GEAppliances.com

Purchase a GE extended warranty and learn about special discounts that are available while your warranty is still in effect. You can purchase it on-line anytime, or call 800-626-2224 during normal business hours. GE Consumer Home Services will still be there after your warranty expires.

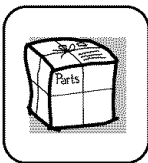

Parts and Accessories

www.GEAppliances.com

Individuals qualified to service their own appliances can have parts or accessories sent directly to their homes (VISA, MasterCard and Discover cards are accepted). Order on-line today, 24 hours every day or by phone at 800-626-2002 during normal business hours.

Instructions contained in this manual cover procedures to be performed by any user. Other servicing generally should be referred to qualified service personnel. Caution must be exercised, since improper servicing may cause unsafe operation.



Contact Us

www.GEAppliances.com

If you are not satisfied with the service you receive from GE, contact us on our Website with all the details including your phone number, or write to: General Manager, Customer Relations
GE Appliances, Appliance Park
Louisville, KY 40225



Register Your Appliance

www.GEAppliances.com

Register your new appliance on-line—at your convenience! Timely product registration will allow for enhanced communication and prompt service under the terms of your warranty, should the need arise. You may also mail in the pre-printed registration card included in the packing material, or detach and use the form in this Owner's Manual.