

use & care guide

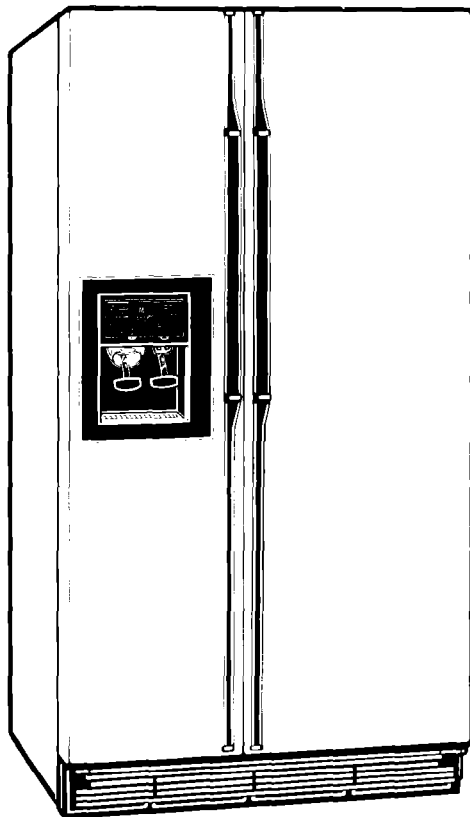

ELECTRA III

**NO-FROST
REFRIGERATOR-
FREEZER**

Model ED25PS

Refrigerators - Freezers - Ice Makers - Dishwashers - Built-In Ovens and Surface Units - Ranges - Microwave Ovens - Trash Compactors - Room Air Conditioners - Dehumidifiers - Automatic Washers - Clothes Dryers - Freezers

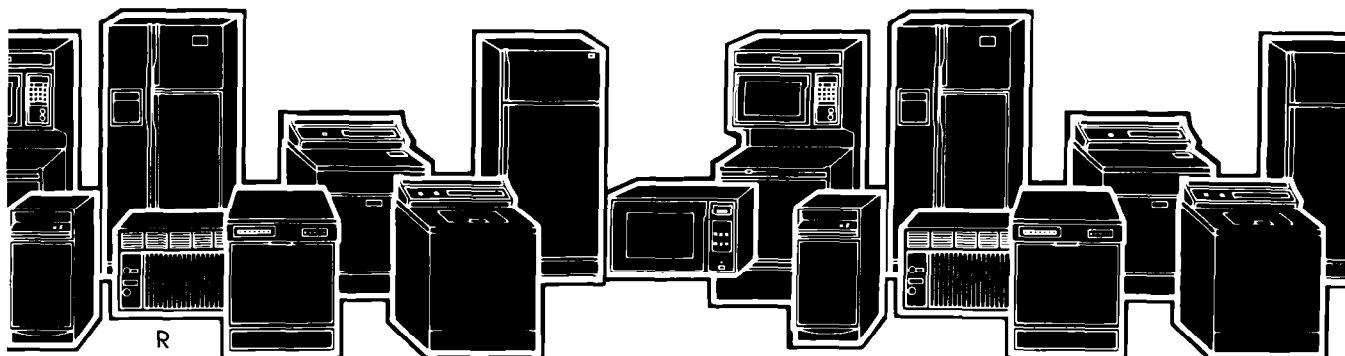

Please read this Use and Care Guide before you do anything else...

This booklet tells you how to start your refrigerator, clean it, move shelves and adjust controls. It even tells you what new sounds to expect from your refrigerator.

Treat your new refrigerator with care. Use it only to do what home refrigerators are designed to do.

Parts and features

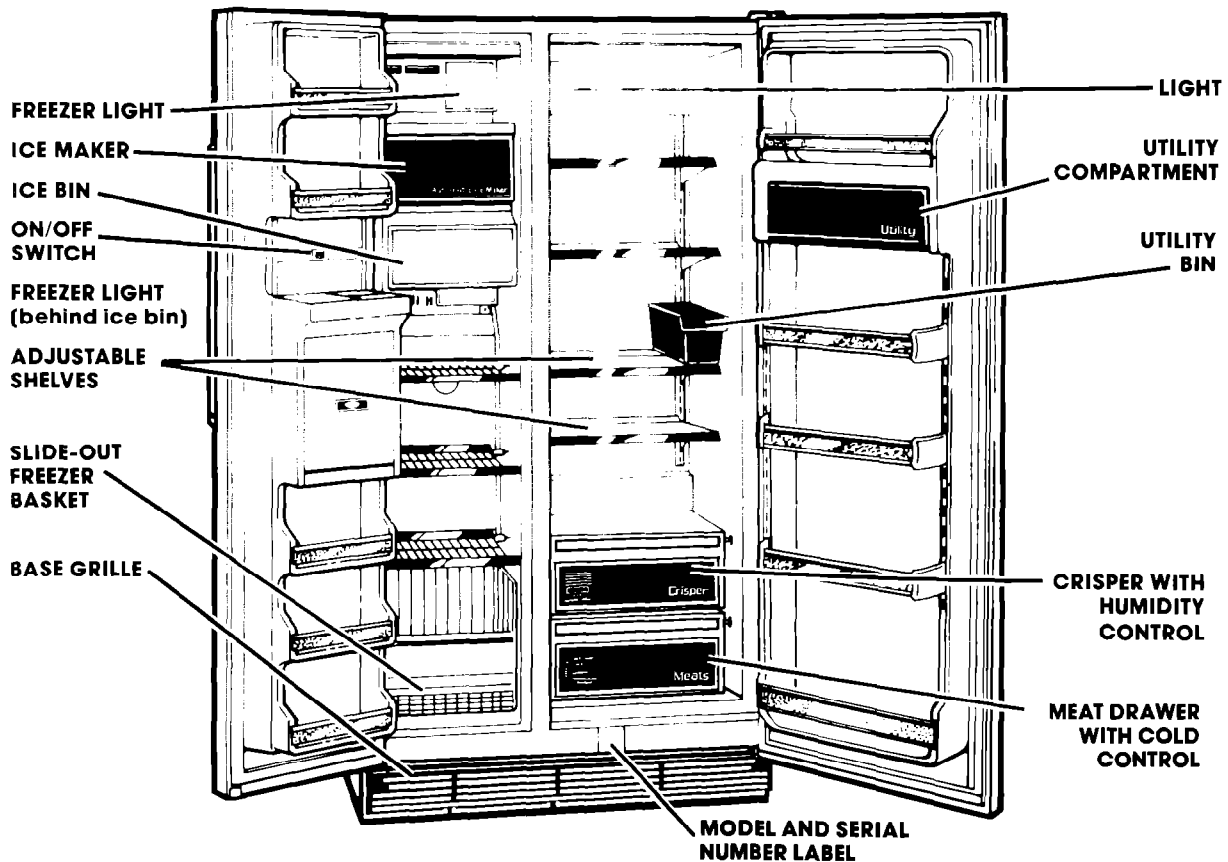

Copy your Model and Serial Numbers here...

When you need service or call with a question, have this information ready:

1. **Complete** Model and Serial Numbers (from the label located as shown)
2. Purchase date from sales slip

Copy this information in these spaces. Keep this book, your warranty and sales slip together in a handy place.

Please complete and mail the Owner Registration card furnished with this product.

Model Number _____

Serial Number _____

Purchase Date _____

Service Company and Telephone Number _____

Contents

	Page		Page
SAFETY FIRST	3	Adjusting the Refrigerator Shelves	8
BEFORE YOU PLUG IT IN	3	Removing the Freezer Basket	8
Install Properly	4	Removing the Crisper, Meat Drawer and Cover	9
Level Refrigerator-Freezer	4	Changing the Light Bulbs	9
Remove Sales Labels	4	Removing the Base Grille	9
Clean It	4	Ice and Cold Water Dispenser	10
Plug It In	4	Sounds You May Hear	12
Turn Off Beeping	4	Energy Saving Tips	12
ELECTRONIC CONTROL CENTER	5	CLEANING YOUR REFRIGERATOR	13
Display Mode	5	Cleaning Chart	13
Power Saving Pad	5	FOOD STORAGE GUIDE	14
Setting the Temperatures	5	Storing Fresh Food	14
Electronic Display Warning Signals	6	Freezing and Storing Frozen Foods	15
USING YOUR REFRIGERATOR	7	VACATION AND MOVING CARE	18
Adjusting the Crisper Humidity Control	7	IF YOU NEED SERVICE OR ASSISTANCE	19
Adjusting Meat Drawer Temperature	7	REFRIGERATOR WARRANTY	20

© 1987 Whirlpool Corporation

Safety first

Child entrapment and suffocation are not problems of the past. Junked or abandoned refrigerators are still dangerous...even if they will "just sit in the garage for a few days."

If you are getting rid of your old refrigerator, do it safely. Please read the enclosed safety booklet from the Association of Home Appliance Manufacturers. Help prevent accidents.

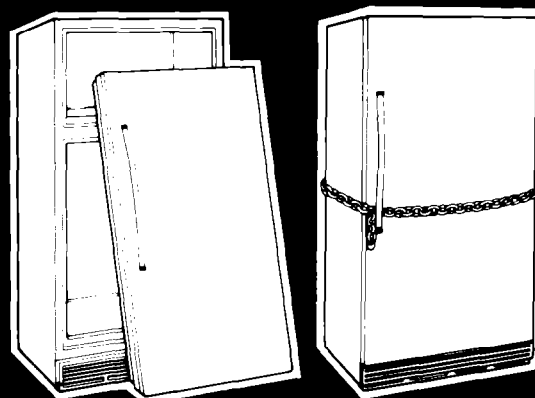

Before you plug it in

Important

Before using your refrigerator, you are personally responsible for making sure that it...

- is installed and leveled on a floor that will hold the weight, and in an area suitable for its size and use.
- is connected only to the right kind of outlet, with the right electrical supply and grounding. (Refer to your "Electrical Requirements and Grounding Instructions.")
- is used only for jobs expected of home refrigerators.
- is not near an oven, radiator or other heat source.
- is properly maintained.
- is out of the weather.
- is used in an area where the room temperature will not fall below 55°F (13°C).
- is not used by those who may not understand how it should be used.
- is not loaded with food before it has time to get properly cold.

Install properly...

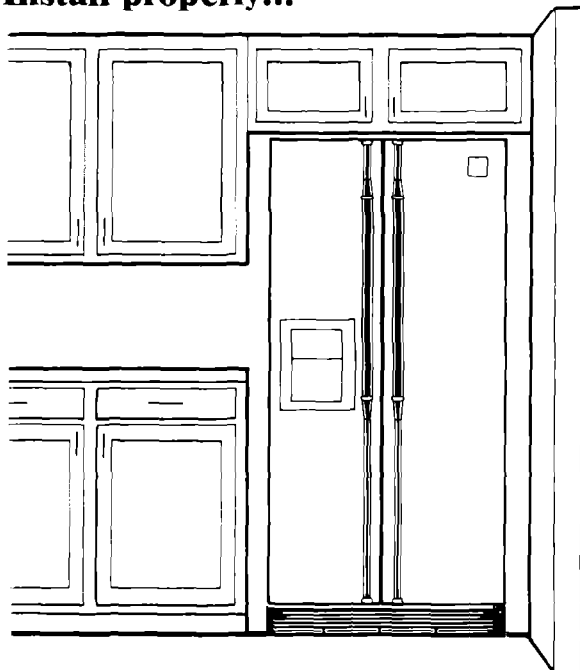

1. Allow ½ inch (1.25 cm) space on each side and at the top of the refrigerator for ease of installation.
2. If the refrigerator is to be against a wall, you might want to leave extra space so the door can be opened wider.
3. The refrigerator back can be flush against the wall.

Level refrigerator-freezer...

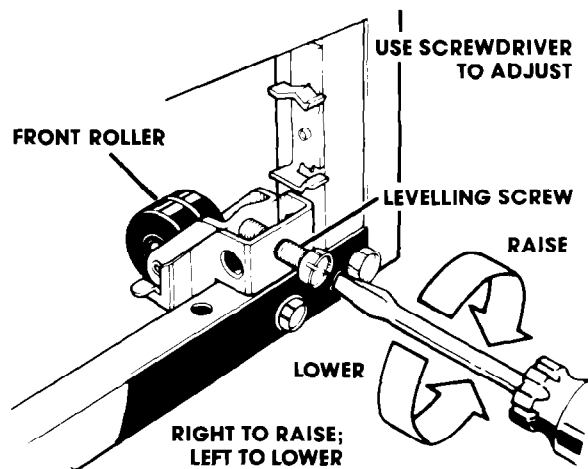

1. Remove base grille (see page 9).
2. To raise front, turn screw in direction shown.
3. To lower front, turn screw in the direction shown.
4. Check with level.

Remove sales labels...

Remove the Consumer Buy Guide label, tape and any **inside** labels before using the refrigerator. **To remove any remaining glue:**

1. Rub briskly with thumb to make a ball then remove.

OR

2. Soak area with liquid hand dishwashing detergent before removing glue as described in step 1.

DO NOT USE rubbing alcohol or flammable or toxic solvents, such as acetone, gasoline, carbon tetrachloride, etc. These can damage the material.

NOTE: DO NOT REMOVE ANY PERMANENT INSTRUCTIONS LABELS INSIDE YOUR REFRIGERATOR.

Do not remove the Tech sheet fastened under the refrigerator at the front.

Clean it...

Clean your refrigerator before using it. See cleaning instructions on page 13.

Plug it in...

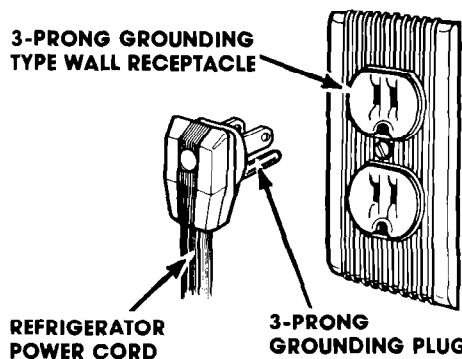

A 115 Volt, 60 Hz., AC only 15 or 20 ampere fused and properly grounded electrical supply is required. It is recommended that a separate circuit serving only this appliance be provided.

Do not use an extension cord. Use a receptacle which cannot be turned off with a switch or pull chain. See individual electrical requirements and grounding instructions sheet in your literature package.

The ON/OFF switch (inside the freezer door just above the ice dispensing slot) should be set to ON before you plug the refrigerator in for the first time. The refrigerator temperature is preset to 36°F (2°C), the freezer to 0°F (-18°C).

Turn off beeping...

The warm refrigerator and freezer temperature warnings will beep eight times every two minutes when the refrigerator is first plugged in. To turn beeping off until refrigerator and freezer reach normal temperatures press and hold the RESET Pad until two beeps are heard (see Display Mode, page 5).

Electronic control center

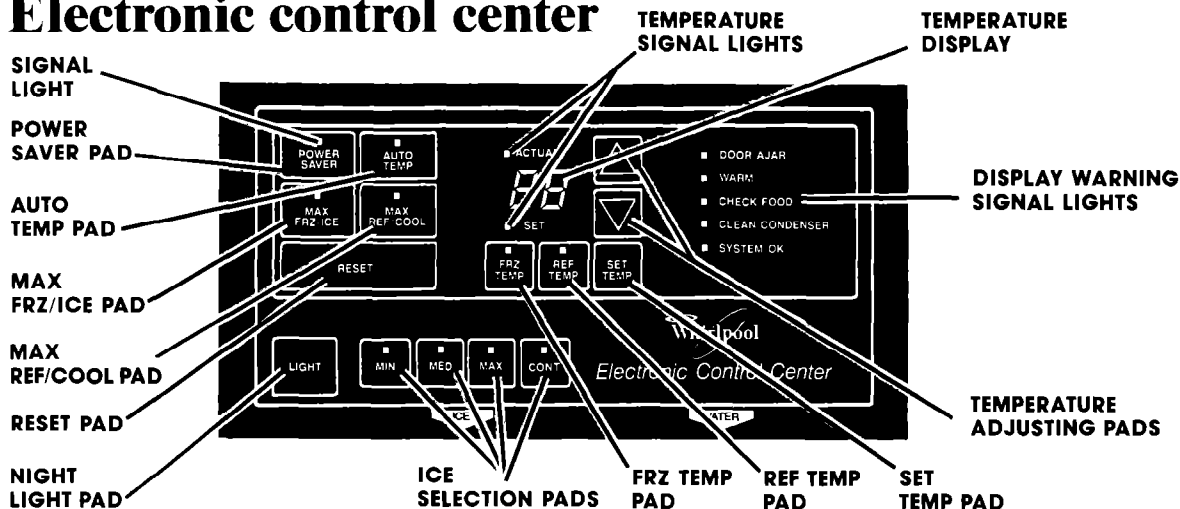

A beep will be heard each time a control pad is pressed. The signal light on a control pad will come on when that control is first pressed.

Display mode...

The display mode is used to demonstrate the Electronic Control Center. Using the display mode will also turn off the beeping from the warning signals. The refrigerator will continue to operate normally while the Electronic Control Center is in the display mode.

To start the display mode, press and hold the RESET Pad until two beeps are heard. While in the display mode, the five signal lights will flash. Pressing the control pads during the display mode will not change any settings. However, if a control pad is pressed, you will hear a beep and the signal light will come on.

To cancel the display mode press the RESET Pad once. The display mode will automatically cancel after being on for 8 hours.

NOTE: If the display mode is entered while the ON/OFF switch is OFF, "CO" will show on the display. You must set the ON/OFF switch to the ON position before the refrigerator will start cooling.

Power saving pad...

The POWER SAVER Pad on the Electronic Control Center operates low wattage electric heaters around the door openings. These heaters keep moisture from forming on the outside of the refrigerator when the humidity is high.



1. When humidity is low, press the POWER SAVER Pad to turn the Power Saver signal light on. This will turn off the heaters.



2. If moisture forms on the outside of the refrigerator, press the POWER SAVER Pad to turn the Power Saver signal light off. This will turn the heaters on.

Setting the temperatures...

When the refrigerator is first plugged in, the freezer temperature is preset to 0°F (-18°C) and the refrigerator is preset to 36°F (2°C).

Give the refrigerator time to cool down completely before adding food. (This may take several hours).

These settings should be about right for normal household refrigerator usage.

The temperatures will be set about right when milk or juice is as cold as you like and ice cream is firm.

If you need to adjust temperatures in the refrigerator or freezer do the following:

- Adjust the refrigerator or freezer temperature.
- Wait at least 24 hours.
- If needed, make further temperature adjustments to the refrigerator or freezer.

To check the actual and set temperatures:



1. Press the FRZ TEMP or REF TEMP Pad. The signal light on the pad you pressed and the ACTUAL signal light will come on. The **actual** refrigerator or freezer temperature will be displayed. (This is the average air temperature in the compartment.)



2. Press the SET TEMP Pad. The SET signal light will come on and the **set** temperature will be displayed. You may set freezer temperatures from -5°F (-21°C) to 8°F (-13°C) and refrigerator temperatures from 33°F (1°C) to 42°F (6°C).

NOTE: If the actual freezer temperature is above the display range, a flashing 8 will show on the display. If the actual refrigerator temperature is above the display range, a flashing 42 will show on the display.

To change the refrigerator or freezer temperatures:

The refrigerator and freezer temperatures are preset at 36°F (2°C) and 0°F (-18°C). If you wish to change these temperatures do the following:



1. Press the FRZ TEMP or REF TEMP Pad. The signal light on the pad you pressed will come on and the **actual** refrigerator or freezer temperature will be displayed.



2. Press the SET TEMP Pad. The SET signal light will come on and the **pre-set** temperature will be displayed.



3. Press the ▲ Pad to raise the temperature setting or press the ▼ Pad to lower the temperature setting. You must press these pads within 10 seconds of pressing the SET pad or you will have to press SET again.

NOTE: Two beeps will sound to indicate an error if you attempt to set a temperature past the refrigerator or freezer temperature range.

Two beeps will sound to indicate an error if you press the arrow pads without pressing the SET pad.

To return to preset temperatures (AUTO TEMP):



1. Press the AUTO TEMP Pad.
2. The signal light will come on for 10 seconds to show that the temperature has been set, then the light will turn off.

Using AUTO TEMP will set the freezer temperature to 0°F (-18°C) and the refrigerator to 36°F (2°C).

To set MAX FRZ/ICE and MAX REF/COOL:

The MAX FRZ/ICE Pad will set the freezer to -10°F (-23°C) for 24 hours. The MAX REF/COOL Pad will set the refrigerator to 33°F (1°C) for 24 hours. Either compartment can be set independently for maximum cooling. MAX FRZ/ICE can also be used for maximum ice production. After 24 hours, the temperatures will return to the earlier settings.



1. Press the MAX FRZ/ICE or MAX REF/COOL Pad. The signal light on the pad you pressed will come on.



2. To cancel the MAX FRZ/ICE and MAX REF/COOL settings press the RESET Pad.

NOTE: Each time you press a maximum cooling pad a new 24 hour cycle will start.

Electronic display warning signals...

The five signal lights on the right side of the Electronic Control Center will show if an action is needed or if there is a problem.

DOOR AJAR (red flashing light)

- The DOOR AJAR light flashes when either door is open.
- Eight beeps sound when either door is open for longer than 3 minutes. Beeps are heard every 2 minutes until door(s) are closed.

WARM (red flashing light)

- The WARM light flashes when the refrigerator and/or freezer temperature(s) **are** above $48^{\circ}\text{F}/15^{\circ}\text{C}$ ($9^{\circ}\text{C}/-9^{\circ}\text{C}$).
- Eight beeps sound every 2 minutes.
- The FRZ TEMP and/or REF TEMP signal light(s) will also flash to show which compartment is too warm.
- Open compartment door(s) less often. Check the set temperatures.

WARM (red light)

- The WARM light is on when refrigerator and/or freezer temperature(s) **were** above $48^{\circ}\text{F}/15^{\circ}\text{C}$ ($9^{\circ}\text{C}/-9^{\circ}\text{C}$) but are now in a safe temperature range.
- The FRZ TEMP and/or REF TEMP signal light(s) will also stay on to show which compartment was too warm.
- The signal lights can be turned off by pressing the RESET Pad.

CHECK FOOD (red flashing light)

- The CHECK FOOD light flashes when refrigerator and/or freezer **are** above safe temperature(s) and have been for 4 hours or more.
- The WARM, FRZ TEMP and/or REF TEMP signal lights will also flash.
- Check food for spoilage. Check the set temperature.
- Call for service, if necessary.

CHECK FOOD (red light)

- The CHECK FOOD light is on when refrigerator and/or freezer **were** above safe temperature(s) and had been for 4 hours or more but are now at safe temperatures.
- The WARM, FRZ TEMP and/or REF TEMP signal lights will also be on.
- The signal lights can be turned off by pressing the RESET Pad.

CLEAN CONDENSER (red light)

- This light reminds you to check the condenser coils behind the grille and clean if necessary.
- The signal light can be turned off by pressing the RESET Pad.
- The signal light will come on 60 days after the refrigerator is plugged in and every 60 days after the signal light is turned off by pressing RESET.

NOTE: If power is interrupted or refrigerator is unplugged, a new 60 day cycle starts.

NOTE: Pressing the RESET Pad once will cancel MAX FRZ and MAX REF (if on), reset the CLEAN CONDENSER light and timer and turn off the solid WARM, CHECK FOOD, FRZ TEMP and REF TEMP signal lights.

To turn on the night light:

1. Press the LIGHT Pad.
2. To turn the light off, press the LIGHT Pad again.

SYSTEM OK (red light)

- The red signal light shows the refrigerator and freezer are running properly.

SYSTEM OK (red flashing light)

- The signal light flashes to show that there may be a problem.
- Call for service.
- The signal light will flash until the problem is corrected.

SYSTEM OK (no light)

- The signal light will turn off if the CHECK FOOD signal light is flashing.

The ice dispenser controls...

The MIN/MED/MAX/CONT Pads control the amount of ice that comes from the dispenser (see page 10).

Using your refrigerator

Adjusting the crisper humidity control...

You can control the amount of humidity in the moisture-sealed crisper.

1. The control can be adjusted to any setting between LO and HI.
2. **LO** (open) lets moist air out of crisper for best storage of fruits and vegetables with skins.
3. **HI** (closed) keeps moist air in the crisper for best storage of fresh leafy vegetables.

NOTE: If moisture builds up in the crisper, move the control to a lower setting.



Adjusting the meat drawer temperature...

Cold air flows against the meat drawer through an opening between the freezer and the refrigerator. This helps keep the meat drawer colder than the rest of the refrigerator.

Set the control beside the meat drawer to raise or lower the temperature.



USE CONTROL TO ADJUST MEAT DRAWER TEMPERATURE

Adjusting the refrigerator shelves...

Shelves can be adjusted to match the way you use your refrigerator. Glass shelves are strong enough to hold bottles, milk and other heavy food items.

GLASS SHELVES ARE HEAVY. BE CAREFUL.

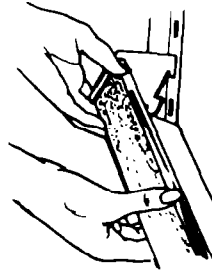
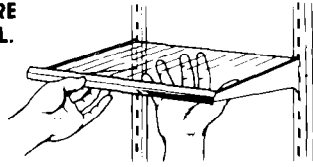

To remove glass shelves:

1. Tilt up at front.
2. Lift up at back.
3. Pull shelf straight out.

To replace glass shelves:

1. Guide the rear hooks into the slots in the shelf supports.
2. Tilt up front of shelf until hooks drop into slot. Lower front of shelf to level position.

The roll-out shelf is removed the same as the other shelves. However, it must be completely rolled in to be removed.

To remove door shelves:

1. Lift shelf up.
2. Tip back and pull out.

To replace door shelves:

1. Insert hooks into guides on both sides.
2. Tip shelf forward and push down.

Removing freezer shelf...

1. Lift front slightly.
2. Lift back off supports.
3. Replace in reverse order.

LIFT THE FRONT THEN THE BACK

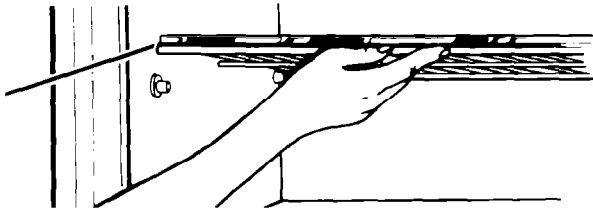

Removing the freezer basket...

For proper air movement, keep the freezer basket in place when the refrigerator is operating.

To remove the basket:

1. Slide out to the stop.
2. Lift the front to clear the stop.
3. Slide out the rest of the way.

To replace the basket:

1. Place basket on the slides.
2. Make sure the wire stops clear the front of the slides.
3. Slide basket in.

PULL TO STOP, LIFT, PULL AGAIN.

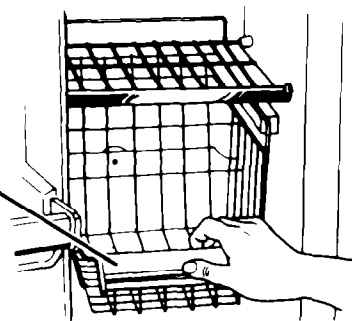

Removing the crisper, meat drawer and covers...

To remove the crisper and meat drawer:

1. Slide crisper and meat drawer straight out to stop.
2. Lift the front.
3. Slide the rest of the way out.
4. Replace in reverse order.

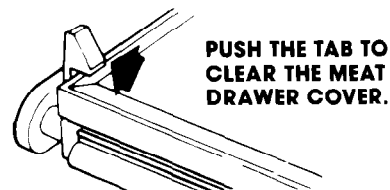

To remove the covers:

- Covers are held in place by two pegs at the back and two notched tabs in front.
1. Press front tabs out of the way.
 2. Lift cover front.
 3. Lift back off the pegs.
 4. Replace in reverse order.

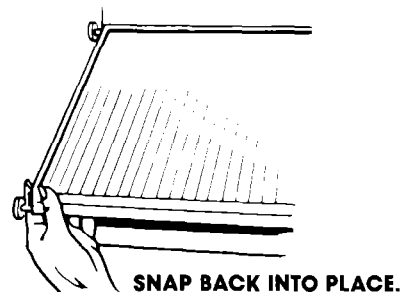

Changing the light bulbs...



WARNING: Before removing a light shield for cleaning or for replacing a light bulb, either unplug the refrigerator or disconnect the electricity leading to the refrigerator at the main power supply. Shock and injury can occur if electricity remains connected.

Light bulbs behind top refrigerator and freezer light shields:

1. Pull bottom of light shield straight out.
2. Lift top of shield off supports.
3. Replace with a 40-watt appliance bulb.
4. Replace panel in reverse order.

Light bulb behind ice maker:

1. Remove the ice bin (see ice maker instructions page 11).
2. Replace bulb with a 40-watt appliance bulb.
3. Replace ice bin.

Dispenser light:

1. Reach the bulb through the dispenser area.
2. Pull down on bulb. Do not twist.
3. Replace with a 12 volt bulb (Part No. GE 904). This bulb is available in the automotive department of most stores.

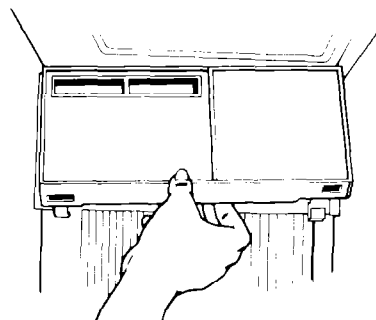

PULL OUT AT THE BOTTOM.

Removing the base grille...

To remove the grille:

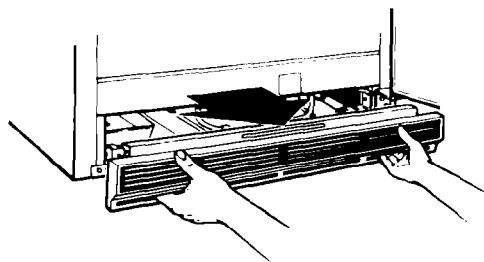

1. Open the doors.
2. Pull grille outwards as shown.
3. **Do not remove Tech sheet** fastened behind grille.

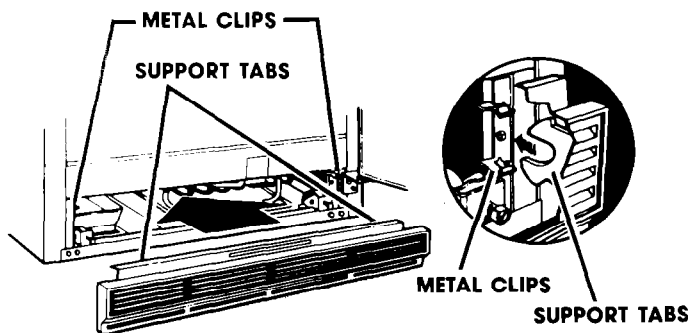

To replace the grille:

1. Line up grille support tabs with metal clips.
2. Push firmly to snap into place.
3. Close the doors.

Ice and cold water dispenser...

FOR ICE:

Press a **sturdy** glass against the ice dispenser bar. (Pressure and tumbling ice can break a fragile glass.)

The first few batches of ice from the ice maker may have a bad taste from new plumbing and parts. Throw them away.

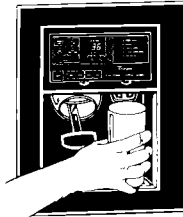

FOR CHILLED WATER:

Press a **sturdy** glass against the water dispenser bar. (Pressure can break a fragile glass.) Remove the glass to stop dispensing.

Dispense enough water every week to maintain a fresh supply.

PRESS AGAINST ICE DISPENSER BAR

The small tray beneath the dispenser is designed to evaporate **small** spills. There is not drain in this tray. **Do not pour water into it.**

Chilled water comes from a tank behind the meat drawer. It holds about 50 ounces (1.5L).

When the refrigerator is first hooked up press the water dispenser with a glass or jar until you have drawn and discarded 2 or 3 quarts (1.9 to 2.8L).

The water you draw and discard will rinse the tank and pipes.

Allow several hours to chill the first tankful.

Ice is dispensed from the ice maker storage bin in the freezer. When the dispenser bar is pressed, a trapdoor opens in a chute between the dispenser and the ice bin. Ice is moved from the bin and falls through the chute. When the trapdoor closes, a faint buzzing sound may be heard for a few seconds.

The MIN/MED/MAX and CONT Pads control the amount of ice dispensed at one time. Select the setting that meets your family's needs.

The CONT setting will dispense ice as long as the ice dispenser bar is held.

NOTE: Large amounts of ice should be taken from the bin, not through the dispenser. The MAX FRZ/ICE setting can be used for maximum ice production.

To set the ice control:

1. Press the Ice Selection Pad for the amount of ice you want. The signal light on the pad will come on briefly
2. This amount of ice will be dispensed each time the ice dispenser bar is pressed. Press another Ice Selection Pad to change the setting.

Common Problems

PROBLEM	CAUSE	SOLUTION
Dispenser won't work.	Freezer door open	<ul style="list-style-type: none"> • Close the freezer door.
Ice dispenser won't work.	Ice bin not properly installed. Wrong ice in bin.	<ul style="list-style-type: none"> • Make sure bin is pushed all the way in. • Use only ice crescents from ice maker. Other shapes won't dispense properly.
Ice dispenser stops working.	Ice dispenser control set on MIN, MED or MAX. Ice dispenser bar held in too long	<ul style="list-style-type: none"> • Select CONT setting • Wait about 3 minutes for the dispenser motor to reset. • Large amounts of ice should be taken from the bin, not through the dispenser.
Off-taste or odor in ice.	Ice attracts airborne odors. Old ice. Water quality. Foods not properly wrapped. Ice bin and freezer may need cleaning. Plumbing to ice maker New ice maker.	<ul style="list-style-type: none"> • Use rapidly or store in covered container. • Dump old ice and make new supply. • Water containing minerals (such as sulfur) may require a filter to remove. • Wrap properly. See pages 15 and 16. • Clean freezer and ice bin. See Cleaning Chart on page 13. • Follow installation instructions for proper ice maker water supply hook-up. • The first few loads of ice from a new ice maker may have an off-taste. Dump ice and make new supply.

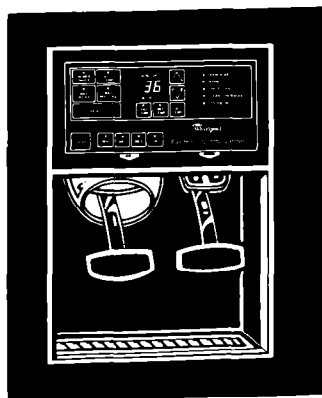

TIPS

- Try different ice dispenser control settings to determine which best meets your family's needs.
- The dispensers will work only with the freezer door closed.
- The ice dispenser will work only if the bin is pushed all the way in.
- **Use only ice crescents from the ice maker.** Other shapes won't dispense properly.
- When you need more ice than a glass or two, scoop it from the bin or remove the bin. The dispenser motor may stop if the dispenser bar is held in too long. It will be ready to run again in about 3 minutes.
- Ice stored too long can go stale...like water. Throw it away.
- Ice can shrink. Cold moving air slowly evaporates them. If you use ice often, you may never notice the change.
- Good water quality is important for good ice quality. It is not recommended that the ice maker be connected to a softened water supply. Water softener chemicals such as salt from a malfunctioning softener can damage the ice maker mold and lead to poor quality ice. If a softened water supply cannot be avoided, then it is important that the water softener be well maintained and operating properly.

Plan to remove and empty the storage bin:

- If the ice dispenser has not, or will not be used for a week or more;
- If a power failure causes ice in the bin to melt and freeze together;
- If the ice dispenser is not used regularly

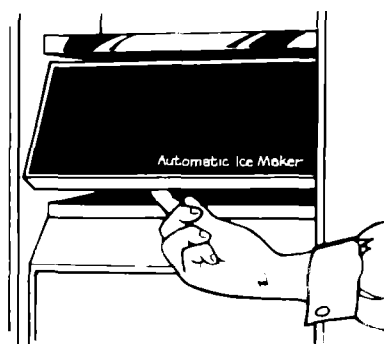

1. Pull the covering panel out from the bottom and slide it to the rear.

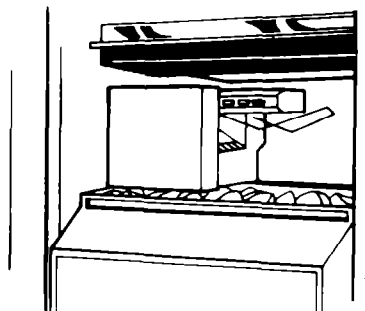

2. Lift the signal arm so it clicks into the OFF position. Ice can still be dispensed, but no more will be made.

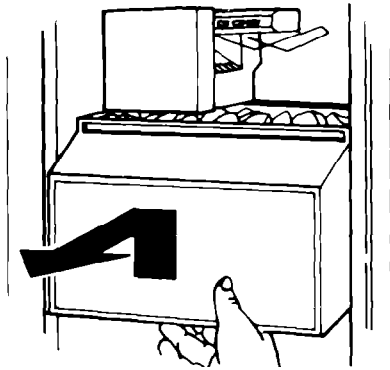

3. Lift the front of the storage bin. Pull it out.
4. Empty the bin. Use hot or warm water to melt the ice if necessary. **Never use anything sharp** to break up ice in the bin. This can damage the bin and dispenser mechanism.
5. Wash with mild detergent. Rinse well. Do not use harsh or abrasive cleansers or solvents.
6. When replacing the bin, make sure it is pushed in all the way. Push the signal arm down to the ON position to restart ice production.

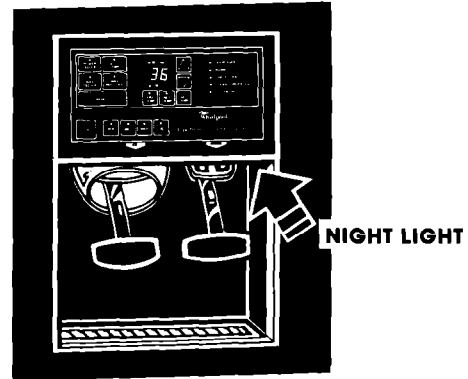

The night light uses a 12V bulb. A replacement bulb (Part No. G.E. 904) is available in the automotive department of most stores.

The night light can be turned on and off by pressing the LIGHT Pad on the Electronic Control Console. The light will also come on while the ice or cold water dispenser bar is pressed.

Sounds you may hear...

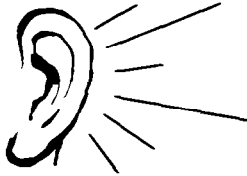

Your new refrigerator may make sounds that your old one didn't. Because the sounds are new to you, you might be concerned about them. Don't be. Most of the new sounds are normal. Hard surfaces like the floor, walls and cabinets can make the sounds seem louder.

The following chart describes the kinds of sounds that might be new to you, and what may be making them.

Possible Sounds:

- Slight Hum, Soft Hiss:
- Clicking or Snapping Sounds:
- Water Sounds:
- Ice Maker Sounds:
 - trickling water
 - thud (clatter of ice)
- Running Sounds:

Probable Causes:

You may hear the refrigerator's fan motor and moving air.

The thermostat makes a definite click when the refrigerator stops running. It also makes a sound when the refrigerator starts. The defrost timer will click when the defrost cycle starts and stops.

When the refrigerator stops running, you may hear gurgling in the tubing for a few minutes after it stops. You may also hear defrost water running into the defrost water pan.

When the ice maker is running you may hear buzzing (from the water valve), trickling water and the clatter of ice dumped into the bin.

Your refrigerator has a high-efficiency compressor and motor. It will run longer than older designs. It may even seem to run most of the time.

Energy saving tips...

You can help your refrigerator use less electricity.

- Check door gaskets for a tight seal. Level the cabinet to be sure of a good seal.
- Clean the condenser coil regularly.
- Open the door as few times as possible. Think about what you need before you open the door. Get everything out at one time. Keep foods organized so you won't have to search for what you want. Close door as soon as food is removed.
- Go ahead and fill up the refrigerator, but don't overcrowd it so air movement is blocked

- It is a waste of electricity to set the refrigerator and freezer to temperatures colder than they need to be. If ice cream is firm in the freezer and drinks are as cold as your family likes them, that's cold enough.
- Keep the POWER SAVER Pad set to ON (signal light on) unless moisture forms on the refrigerator exterior.
- Make sure your refrigerator is not next to a heat source such as a range, water heater, furnace, radiator or in direct sunlight.

Cleaning your refrigerator

Both the refrigerator and freezer sections defrost automatically. But both should be cleaned about once a month to help prevent odors from building up. Of course, spills should be wiped up right away.

To clean your refrigerator, unplug it, take out all removable parts, and clean it according to the following directions.

Cleaning chart...

Part	What to use	How to clean
Removable parts (shelves, crisper, meat drawer, etc.)	Sponge or cloth; mild detergent and warm water.	<ul style="list-style-type: none"> • Wash removable parts with warm water and a mild detergent. • Rinse and dry.
Outside	Sponge, cloth or paper towel; mild detergent; appliance wax (or good auto paste wax).	<ul style="list-style-type: none"> • Wash with warm water and a mild detergent. Do not use abrasive or harsh cleansers. • Rinse and dry. • Wax painted metal surfaces at least twice a year with appliance wax or a good auto paste wax. Apply wax with a clean, soft cloth. Do not use wax on plastic parts.
	Waxing painted metal surfaces provides rust protection.	
Inside walls (Freezer should be allowed to warm up so cloth won't stick.)	Sponge, soft cloth or paper towel, baking soda, warm water, mild detergent.	<ul style="list-style-type: none"> • Wash with warm water and <ul style="list-style-type: none"> – mild detergent or – baking soda (2 tablespoons [26 g] to 1 quart [.95 L.] warm water). • Rinse and dry.
Door liners and gaskets	Sponge, soft cloth or paper towel; mild detergent, warm water.	<ul style="list-style-type: none"> • Wash with mild detergent and warm water. • Rinse and dry.
	DO NOT USE Cleaning waxes, concentrated detergents, bleaches or cleansers containing petroleum on plastic parts.	
Dark plastics (covers and panels)	Mild detergent and warm water; soft clean sponge and soft, clean cloth.	<ul style="list-style-type: none"> • Wash with a soft cloth or sponge. • Rinse and dry.
	DO NOT USE paper towels, window sprays, scouring cleansers, or flammable or toxic solvents like acetone, gasoline, carbon tetrachloride, etc. These can scratch or damage the material.	
Defrost pan	Sponge or cloth; mild detergent and warm water.	<ul style="list-style-type: none"> • Remove base grille. (See page 9.) • To remove defrost pan, lift pan over wire brace (remove tape; if any). • Wash defrost pan with warm water and mild detergent. • Rinse and dry. • Replace with notched corner to the rear. Push it all the way in. • Make sure defrost drain tube is pointing into pan. • Replace base grille.
Condenser Coil	Vacuum cleaner; using the extended narrow attachment.	<ul style="list-style-type: none"> • Remove base grille. • Clean dust and lint from condenser at least every other month. • Replace base grille.
Floor under refrigerator	Usual floor cleaners	<ul style="list-style-type: none"> • Roll refrigerator out only as far as water supply line allows. • Clean the floor. • Roll refrigerator back. • Check to see if the refrigerator is level.

Food storage guide

STORING FRESH FOOD



There is a right way to package and store refrigerated or frozen foods. To keep foods fresher, longer, take the time to study these recommended steps.

Leafy Vegetables...Remove store wrapping and trim or tear off bruised and discolored areas. Wash in cold water and drain. Place in plastic bag or plastic container and store in crisper. Cold, moist air helps keep leafy vegetables fresh and crisp.

Vegetables with Skins (carrots, peppers)...Store in crisper, plastic bags or plastic container.

Fruit...Wash, let dry and store in refrigerator in plastic bags or crisper. Do not wash or hull berries until they are ready to use. Sort and keep berries in their store container in a crisper, or store in a loosely closed paper bag on a refrigerator shelf.



Meat*...Meat is perishable and expensive...you won't want to waste an ounce of it through careless handling. The following list and chart give you packaging hints and time limits. Store meat in the meat drawer.

Fresh, Prepackaged Meat. Store fresh meat in the store wrapping. Vacuum packaged meat can be frozen for as long as one month if the seal is not broken. If you want to keep it frozen longer, you should wrap it with special freezer wrapping material.

Fresh Meat, Not Prepackaged. Remove the market wrapping paper and re-wrap in aluminum foil for storing it unfrozen.

Cooked Meat. Wrap or cover cooked meat with plastic wrap or aluminum foil. Store immediately.

Cured or Smoked Meat and Cold Cuts. Ham, bacon, sausage, cold cuts, etc., keep best in original wrappings. Once opened, tightly re-wrap in plastic wrap or aluminum foil.

Canned Ham. Store in refrigerator unless the label says it's okay to store on the shelf. Do not freeze.

Fresh Poultry...Wrap in plastic wrap. The plastic on poultry, as purchased, may be used for storage.

STORAGE CHART FOR FRESH AND CURED MEAT*

Type	Approximate Time (days)
Variety Meats	1 to 2
Chicken	1 to 2
Ground Beef	1 to 2
Steaks and Roasts	3 to 5
Cured Meats	7 to 10
Bacon	5 to 7
Cold Cuts	3 to 5

*If meat is to be stored longer than the times given, follow the directions for freezing.

NOTE: Fresh fish and shellfish should be used the same day as purchased.

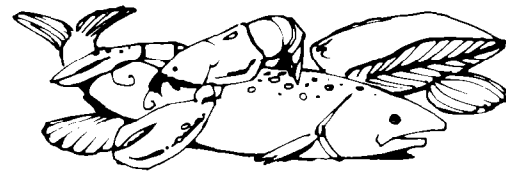

Eggs...Store without washing in the original carton or use the Utility Bin that came with your refrigerator.

Milk...Wipe milk cartons. For best storage, place milk on interior shelf or bottom door shelf.

Beverages...Wipe bottles and cans. Store on a door shelf or inside the refrigerator.

Butter...Keep opened butter in covered dish or in the Utility Compartment. When storing an extra supply, wrap in freezer packaging and freeze.

Cheese...Store in the original wrapping until you are ready to use it. Once opened, re-wrap tightly in plastic wrap or aluminum foil.

Condiments...Store small jars and bottles (catsup, mustard, jelly, olives) on the door shelves where they are in easy reach.

Leftovers...Cover leftovers with plastic wrap or aluminum foil to keep food from drying out and transferring food odors. Plastic containers with tight lids are fine, too.

FREEZING & STORING FROZEN FOODS

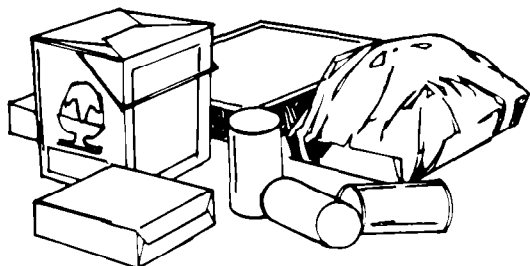

The freezer section is designed for storage of commercially frozen foods and for freezing foods at home.

Packaging – The secret of successful freezing is in the packaging. The wrap you use must be air, moisture and vapor proof. The way you close and seal the package must not allow air, moisture or vapor in or out. Packaging done in any other way could cause food odor and taste transfer throughout the refrigerator and drying of frozen food.

Rigid polyethylene (plastic) containers with tightfitting lids, straight-sided canning/freezing jars, heavy-duty aluminum foil, plastic-coated paper and nonpermeable plastic wraps (made from a saran film) are recommended. **NOTE: Heat-sealed boiling bags are easy to use and can be used by themselves or as carton liners.**

Sealing – When sealing foods in bags squeeze out the air (liquids need headspace to allow for expansion). Twist the top and turn it back. Fasten tie securely around the doubled-over tail. Put the label inside transparent bags; use self-adhesive label on outside of opaque ones.

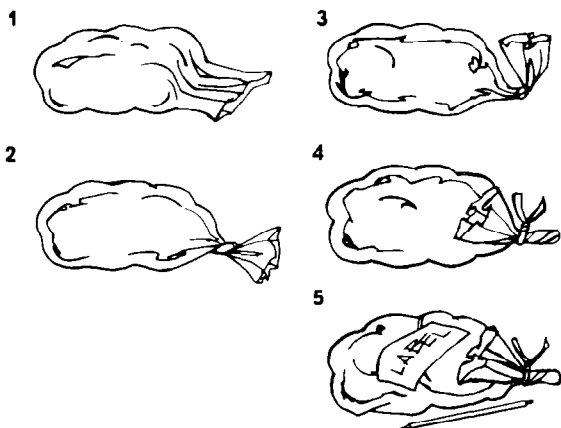

Air-tight wrapping calls for “drugstore” wrap. Cut the sheet about one-third longer than the distance around the food. Bring the ends together and fold in (toward the food) at least twice to seal out air. Crease ends close to food, press air from package. Fold tips over twice. Finish package and tape closed. **NOTE: With unboned meats, pad sharp edges with extra wrap or use stockinette to protect the wrap from punctures.**

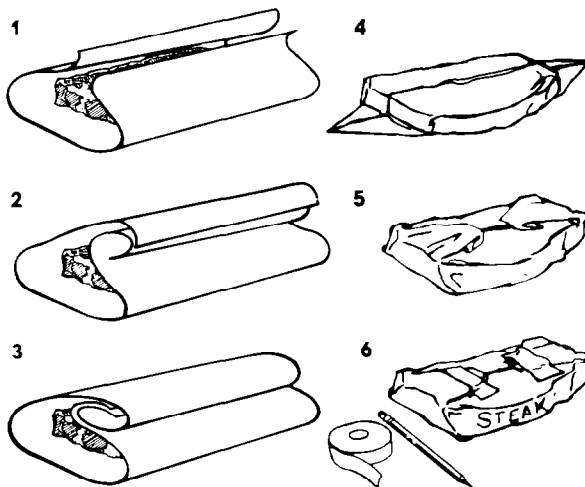

DO NOT USE:

- Bread wrappers
- Non-polyethylene plastic containers
- Containers without tight lids
- Waxed paper
- Waxed-coated freezer wrap
- Thin, semi-permeable wrap

None of these are totally moisture, air or vapor proof. The use of these wrappings could cause food odor and taste transfer and drying of frozen food.

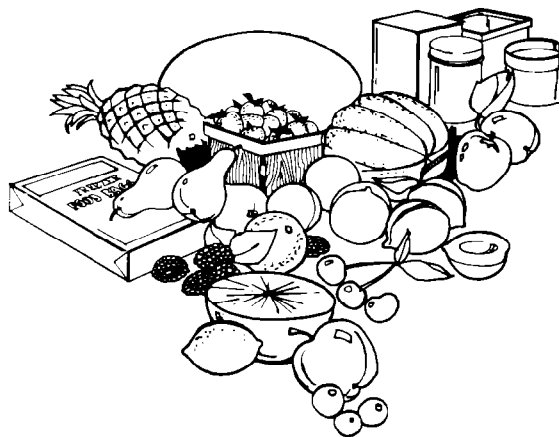

Freezing Fruits – Select ripe, blemish-free fruits. Be sure they taste as good as they look. Wash 2 to 3 quarts (liters) at a time and drain. Fruit that stands in water may lose food value and become soggy. Sort, peel, trim, pit and slice as needed.

Pack in rigid wide-mouthed containers or other recommended material. Leave head space to allow liquids to expand during freezing.

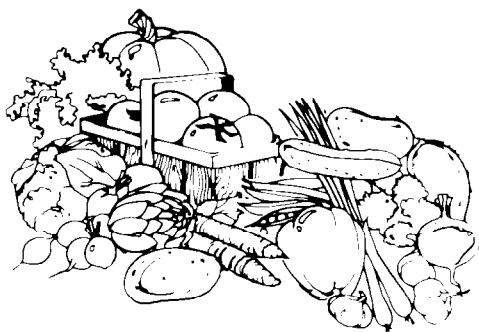

Freezing Vegetables – Freeze only fresh high-quality vegetables picked when barely mature. For best results, freeze no more than 2 to 3 hours after picking. Wash in cold water, sort and cut into appropriate sizes. Blanch or scald. Pack in recommended container and freeze.

Do not freeze lettuce, celery, carrot sticks, potatoes or fresh tomatoes. All will become limp or mushy. Tomatoes will collapse when thawed.



Freezing Meats – The meat you thaw can only be as good as the meat you freeze. "Drugstore" wrap in meal-size packages. Flat cuts or patties should be wrapped individually or in layers separated by a double thickness of freezer wrap.

Make sure store wrappings are moisture and vapor proof. If not, re-wrap meats with one of the wraps recommended under "Packaging."

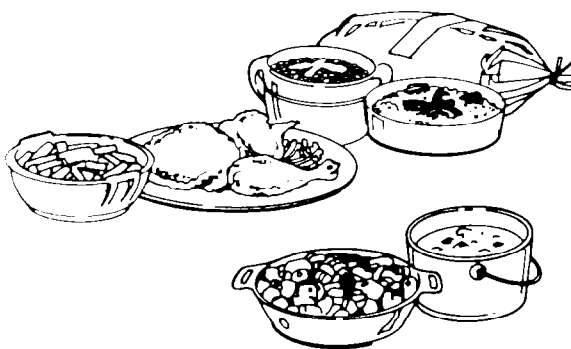

Freezing Cooked Food – Prepare cooked foods as you would for the table; shorten cooking time 10 to 15 minutes to allow for additional cooking during reheating. Omit seasonings and part of the liquid. Plan to add them at reheating time. Potatoes should also be added to soup and stew at heating time. Add crumb and cheese toppings at heating time.

Cool as rapidly as possible and freeze at once. Liquid or semi-liquid dishes may be frozen in recommended containers with *head-space*. Casseroles and other more solid foods may be frozen in the baking container. If you don't want to leave your casserole dish in the freezer, line it with foil. Bake, cool, freeze, lift out the foil package, bag it and return to freezer.

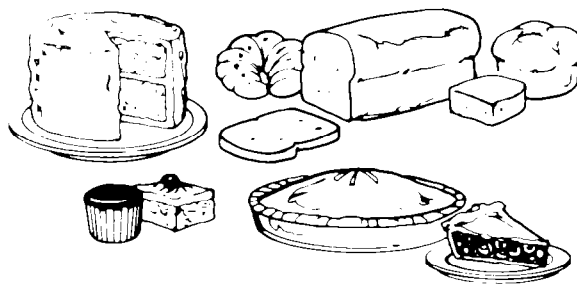

Freezing Baked Goods – Wrap baked breads in recommended material. Thaw in wrapping. Unbaked yeast breads can be frozen after the first rising. Punch down, wrap and freeze.

Bake cookies as usual. Cool and freeze on trays, then pack in recommended freezer bags or cartons. Unbaked cookies may be dropped, molded or rolled and frozen on cookie trays. Store in bag or carton; bake without thawing. Refrigerator-type cookies can be wrapped and frozen in roll form. Thaw only enough to slice when ready to bake.

Fruit pies are best frozen unbaked. Bake without thawing. Bake pecan and similar pies before freezing...rich fillings do not freeze solid. Cut steam vents in top crusts when ready to bake.

IMPORTANT: Do not expect your freezer to quick-freeze any large quantity of food. Put no more unfrozen food into the freezer than will freeze within 24 hours. (No more than 2 to 3 pounds of food per cubic foot of freezer space.) Leave enough space for air to circulate around packages. Be careful to leave enough room at the front so the door can close tightly.

FOOD STORAGE CHART

Storage times* will vary according to the quality of the food, the type of packaging or wrap used (moisture and vapor-proof), and the storage temperature which should be 0°F (-17.8°C).

Food	Storage Time
FRUITS	
Fruit juice concentrate	12 months
Commercially frozen fruit	12 months
Citrus fruit and juices	4 to 6 months
Others	8 to 12 months
VEGETABLES	
Commercially frozen	8 months
Home frozen	8 to 12 months
MEAT	
Bacon	4 weeks or less
Corned beef	4 weeks or less
(Salting meat shortens freezer life)	
Frankfurters	1 month
Ground beef, lamb, veal	2 to 3 months
Roasts:	
Beef	6 to 12 months
Lamb and veal	6 to 9 months
Pork	4 to 8 months
Sausage, fresh	1 to 2 months
Steaks and chops:	
Beef	8 to 12 months
Lamb, veal, pork	3 to 4 months
FISH	
Cod, flounder, haddock	
sole	6 months
Blue fish, salmon	2 to 3 months
Mackerel, perch	2 to 3 months
Breaded fish (purchased)	3 months
Clams, oysters, cooked	
fish, crab, scallops	3 to 4 months
Alaskan king crab	10 months
Shrimp, uncooked	12 months
POULTRY	
Whole chicken or turkey	12 months
Duck	6 months
Giblets	2 to 3 months
Cooked poultry w/gravy	6 months
Slices (no gravy)	1 month
MAIN DISHES	
Stews; meat, poultry and fish casserole	2 to 3 months
TV dinners	3 to 6 months

Food	Storage Time
DAIRY PRODUCTS	
Butter	6 to 9 months
Margarine	12 months
Cheese:	
Camembert, Mozzarella, farmer's	3 months
Creamed cottage	DO NOT FREEZE
Cheddar, Edam, Gouda, Swiss, brick, etc.	6 to 8 weeks
Freezing can change texture of cheese.	
Ice cream, ice milk, sherbet	2 months
EGGS	
Whole (mixed)	12 months
Whites	12 months
Yolks	12 months
(Add sugar or salt to yolks or whole mixed eggs)	
BAKED GOODS	
Yeast breads and rolls	3 months
Baked Brown 'N Serve rolls	3 months
Unbaked breads	1 month
Quick breads	2 to 3 months
Cakes, unfrosted	2 to 4 months
Cakes, frosted	8 to 12 months
Fruit cakes	12 months
Cookie dough	3 months
Baked cookies	8 to 12 months
Baked pies	1 to 2 months
Pie dough only	4 to 6 months
*Based on U.S.D.A. and Michigan Cooperative Extension Service suggested storage times.	

If electricity goes off

Call the power company. Ask how long power will be off.

- If service is to be interrupted 24 hours or less, **keep both doors closed**. This will help frozen foods to stay frozen.
- If service is to be interrupted longer than 24 hours:
 - Remove all frozen food and store in a frozen food locker. Or...
 - Place 2 lbs (0.9 kg) of dry ice in freezer for every cu. ft. of freezer space. This will keep frozen foods for 2 to 4 days. Wear gloves to protect your hands from dry ice burns.
 - If neither food locker storage nor dry ice is available, use or can perishable food at once.
- A full freezer will stay cold longer than a partly filled one. A freezer full of meat will stay cold longer than a freezer full of baked goods. If food contains ice crystals, it may be safely refrozen, although the quality and flavor may be affected. Use refrozen foods quickly. If the condition of the food is poor or you have any suspicions, it is wise to dispose of it.

Vacation and Moving Care



Short vacations...

No need to shut off the refrigerator if you will be away for less than four weeks. Use up perishables; freeze other items.

1. Turn off your ice maker.
2. Shut off the water supply to the ice maker.
3. Empty the ice bin.
4. Make sure all ice cubes are dispensed out of the mechanism.

Long vacations...

Remove all the food if you are going for a month or more. At least a day ahead, turn off the water supply to the ice maker. When the last load of ice drops, turn off the ice maker. Make sure all ice cubes are dispensed out of the mechanism.

Unplug the refrigerator and clean it...rinse well and dry. Tape rubber or wood blocks to both doors...keeping them open far enough for air to get in. This will keep odor and mold from building up.



WARNING: Tape blocks out of a child's reach...do not allow children near the refrigerator when the doors are blocked open. They may become injured or trapped.

To restart refrigerator, see "Using Your Refrigerator."

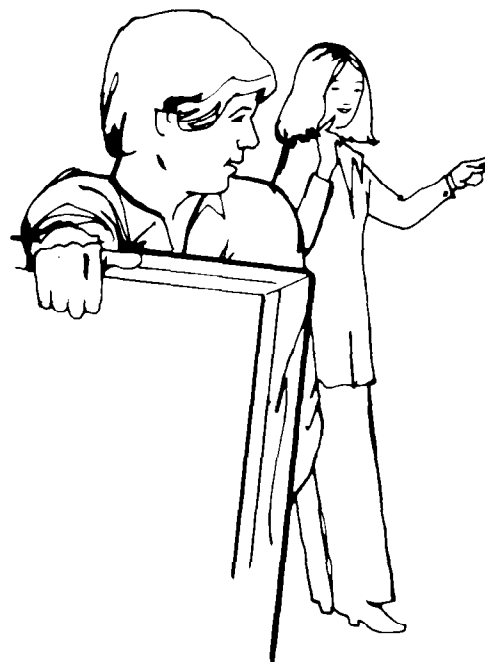

Moving...

Shut off the ice maker water supply a day ahead of time. Disconnect the water line. After the last supply of ice drops, lift the signal arm to turn off the ice maker. Make sure all ice cubes are dispensed out of the mechanism.

Remove all food. Pack frozen foods in dry ice. Unplug the refrigerator and clean it thoroughly.

Remove everything that comes out. Wrap all parts well and tape them together so they don't shift and rattle.

Also, remove the water supply tank behind the meat drawer by:

1. Disconnecting water inlet and outlet tubes at the top of the tank.
2. Removing three mounting screws from the tank.
3. Draining the tank.

Re-install the empty tank, and remember to check for tight water connections when the refrigerator is hooked up at your new location.

Screw in the levelling rollers; tape the doors shut; tape the electric cord to the cabinet. When you get to your new home, put everything back, level the refrigerator, reconnect the water supply and refer to page 4.

Questions?

...call your COOL-LINE® service assistance telephone number (page 19).

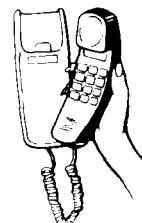

If you need service or assistance, we suggest you follow these five steps:

1. Before calling for assistance...

Performance problems often result from little things you can find and fix yourself without tools of any kind.

If your refrigerator will not operate:

- Is the electric cord plugged into a live circuit with proper voltage? (See page 4.)
- Have you checked your home's main fuses or circuit breaker box?
- Is the Refrigerator Control ON?

If there is a rattling or jingling noise or unfamiliar sounds:

- Is something on top or behind the refrigerator making noise when the refrigerator is running?
- New features on your new refrigerator make new sounds. You may be hearing air flowing from the fans, timer clicks for the defrosting cycle, or defrost water draining in the defrost pan.

If your ice maker will not operate:

- Has the freezer had enough time to get cold? With a new refrigerator, this might take overnight.
- Is the signal arm ON...in the down position?
- Is the water valve turned on? Is water getting to the ice maker?

If there is water in the defrost pan:

- This is normal in hot, muggy weather. The pan can even be half full. Make sure the refrigerator is level so the pan does not overflow.

If the lights are not working:

- Have you checked your home's main fuses or circuit breaker?
- Is the power supply cord plugged into a live circuit with the proper voltage? (See page 4.)

If a bulb is burned out:

- See instructions for changing light bulbs on page 9. Only use appliance bulbs.

If the motor seems to run too much:

- Is the condenser, behind the refrigerator, free of dust and lint?
- On hot days, or if the room is warm, the motor naturally runs longer.
- If the door has been opened a lot, or if a large amount of food has been put in, the motor will run longer to cool down the interior.

Remember: Motor running time depends on different things; number of door openings, amount of food stored, temperature of the room, setting of the controls.

And, your new refrigerator may be larger than your old one so it has more space to be cooled. It also has a regular freezer instead of a frozen food compartment. All this means better refrigeration and may require more running time than your old one.

2. If you need assistance*...

Call Whirlpool COOL-LINE® service assistance telephone number. Dial free from anywhere in the U.S.: **1-800-253-1301**

and talk with one of our trained Consultants. The Consultants can instruct you in how to obtain satisfactory operation from your appliance or, if service is necessary, recommend a qualified service company in your area.

3. If you need service*...



Whirlpool has a nationwide network of franchised TECH-CARE® service companies. TECH-CARE service technicians are trained to fulfill the product warranty and provide after-warranty service, anywhere in the United States. To locate TECH-CARE service in your area, call our COOL-LINE service assistance telephone number (see Step 2) or look in your telephone directory Yellow Pages under:

APPLIANCES - HOUSEHOLD - MAJOR - SERVICE & REPAIR WHIRLPOOL APPLIANCES FRANCHISED TECH-CARE SERVICE <i>SERVICE COMPANIES</i> XYZ SERVICE CO 123 MAPLE ... 999-9999	OR	ELECTRICAL APPLIANCES - MAJOR - REPAIRING & PARTS WHIRLPOOL APPLIANCES FRANCHISED TECH-CARE SERVICE <i>SERVICE COMPANIES</i> XYZ SERVICE CO 123 MAPLE ... 999-9999
OR		
WASHING MACHINES, DRYERS & IRONERS - SERVICING WHIRLPOOL APPLIANCES FRANCHISED TECH-CARE SERVICE <i>SERVICE COMPANIES</i> XYZ SERVICE CO 123 MAPLE ... 999-9999		

4. If you have a problem*...

Call our COOL-LINE service assistance telephone number (see Step 2) and talk with one of our Consultants, or if you prefer, write to:

Mr. Robert Stanley
 Division Vice President
 Whirlpool Corporation
 2000 M-63
 Benton Harbor, MI 49022

5. If you need FSP® replacement parts*...

FSP® is a registered trademark of Whirlpool Corporation for quality parts. Look for this symbol of quality whenever you need a replacement part for your Whirlpool appliance. FSP replacement parts will fit right and work right, because they are made to the same exacting specifications used to build every new Whirlpool appliance.

To locate FSP replacement parts in your area, refer to Step 3 above or call the Whirlpool COOL-LINE service assistance number in Step 2.

*If you must call or write, please provide: model number, serial number, date of purchase, and a complete description of the problem. This information is needed in order to better respond to your request for assistance.

WHIRLPOOL REFRIGERATOR WARRANTY

LENGTH OF WARRANTY	WHIRLPOOL WILL PAY FOR
FULL ONE-YEAR WARRANTY From Date of Purchase	FSP® replacement parts and repair labor to correct defects in materials or workmanship. Service must be provided by a franchised TECH-CARE® service company.
LIMITED FIVE-YEAR WARRANTY From Date of Purchase	FSP replacement parts for electronic control system if defective in materials or workmanship. (Electronic models only.)
FULL FIVE-YEAR WARRANTY From Date of Purchase	FSP replacement parts and repair labor to correct defects in materials or workmanship in the sealed refrigeration system. These parts are: <ol style="list-style-type: none"> 1. Compressor 2. Evaporator 3. Condenser 4. Drier 5. Connecting tubing Service must be provided by a franchised TECH-CARE® service company.
WHIRLPOOL WILL NOT PAY FOR	
<p>A. Service calls to:</p> <ol style="list-style-type: none"> 1. Correct the installation of the refrigerator. 2. Instruct you how to use the refrigerator. 3. Replace house fuses or correct house wiring or plumbing. 4. Replace light bulbs. <p>B. Repairs when refrigerator is used in other than normal, single-family household use.</p> <p>C. Pick up and delivery. This product is designed to be repaired in the home.</p> <p>D. Damage to refrigerator caused by accident, misuse, fire, flood, acts of God or use of products not approved by Whirlpool.</p> <p>E. Any labor costs during limited warranty.</p> <p>F. Any food loss due to product failure.</p>	

WHIRLPOOL CORPORATION SHALL NOT BE LIABLE FOR INCIDENTAL OR CONSEQUENTIAL DAMAGES. Some states do not allow the exclusion or limitation of incidental or consequential damages so this limitation or exclusion may not apply to you. This warranty gives you specific legal rights, and you may also have other rights which vary from state to state.

Outside the United States, a different warranty may apply. For details, please contact your franchised Whirlpool distributor or military exchange.

