

PERFORMANCE DATA NO LOAD AND NO DOOR OPENINGS AT MID-POINT CONTROL SETTING				
Type A With Run/Start Capacitor	65°F (18°C) Ambient	90°F (32°C) Ambient		
Operating Time	32 to 40%	55 to 65%		
Freezer Temperature	0° to 4°F -18° to -16°C	-1° to 3°F -18° to -16°C		
Refrigerator Temperature	34° to 39°F 1° to 4°C	34° to 39°F 1° to 4°C		
Low Side Pressure (cut-in)	5 to 12 psig 34 to 83 kPa	5 to 12 psig 34 to 83 kPa		
Low Side Pressure (cut-out)	-2 to 2 psig -14 to 14 kPa	-2 to 2 psig -14 to 14 kPa		
High Side Pressure (Last 1/3 of cycle)	90 to 115 psig 621 to 793 kPa	130 to 155 psig 896 to 1069 kPa		
Wattage (Last 1/3 of cycle)	120 to 150	130 to 160		
Amps (Running)	1.2 to 1.5	1.2 to 1.5		
Base Voltage	115 vac (127 vac max)	115 vac (127 vac max)		
DEFROST SPECIFICATIONS				
Cabinet Size	Thermostat		Heater	
	Cut-in	Cut-out	Watts	Ohms
23' & 26'	25°F -4°C	47°F 8°C	450	30
Electronic Timer - (ADC) Defrost 24 minutes every 6 to 72 hours of compressor run time.				
CONDENSER FAN MOTOR				
Watts	RPM		Amps	
7	1100 CW Opposite Shaft		.1 Running	
ICE MAKER SPECIFICATIONS				
Electrical	115 vac (127 vac max)		60 Hertz	
Thermostat	Opens at 48°F (9°C)		Closes at 15°F (-9°C)	
Heater Wattage	165			
ICE MAKER CONNECTOR PLUG CONNECTIONS				
Wire Number	Wire Color	Connects to:		
1	Green/Yellow	Ground		
2	Yellow	Water Valve		
3	Black	Line		
4	Lt. Blue	Neutral		

SERVICE DATA SHEET - 240389621

R134a ICE & WATER - AUTOMATIC DEFROST SIDE BY SIDE MODELS

IMPORTANT SAFETY NOTE

The information provided herein is designed to assist qualified repair personnel only. Untrained persons should not attempt to make repairs due to the possibility of electrical shock. Disconnect power cord before servicing this appliance.

IMPORTANT
If any green grounding wires are removed during servicing, they must be returned to their original position and properly secured.

CAUTION

All electrical parts and wiring must be shielded from torch flame. DO NOT allow torch to touch insulation; it will char at 200°F and flash ignite (burn) at 500°F. Excessive heat will distort the plastic liner.

NOTE

This product comes equipped with an Electronic Defrost Control. To initiate defrost, depress the fresh food light switch 5 times in 6 seconds (light bulb must be working). To terminate defrost, depress the fresh food light switch 5 times in 6 seconds.

ICE MAKER INFORMATION

Test Cycling

Press the momentary contact on the ON/OFF switch for approximately 15 seconds. Ice maker will continue to complete the cycle.

Water Fill Volume

Remove cover by inserting screwdriver in notch at bottom and prying cover from housing. The water fill adjustment screw will change the fill time. One turn is equal to 20cc (.68 oz.). The correct fill is 102 to 110cc (3.25 to 3.5 oz.). When a water valve is replaced, the fill volume must be checked

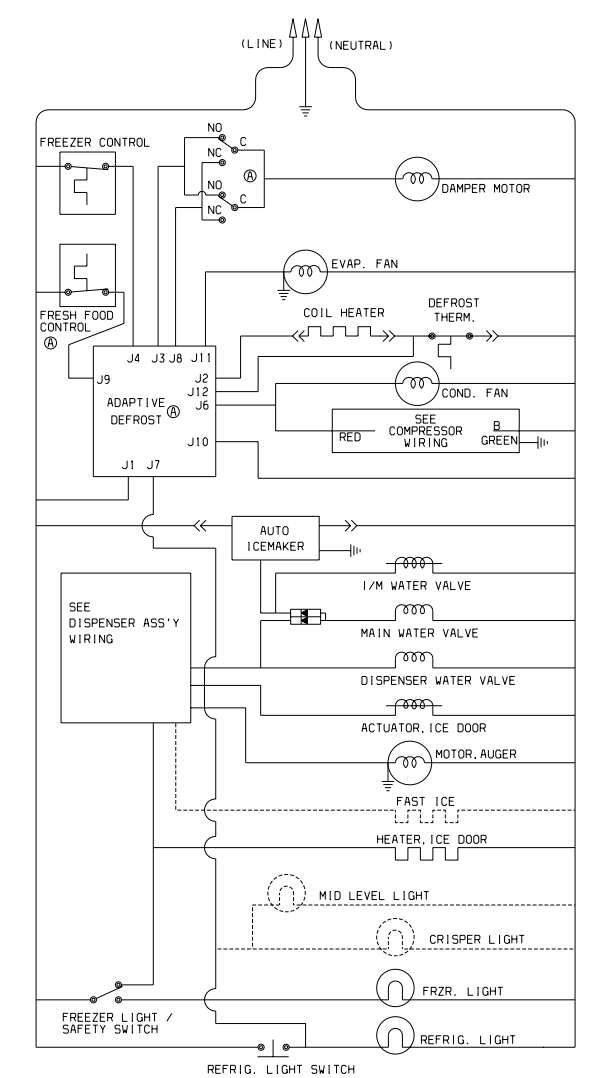
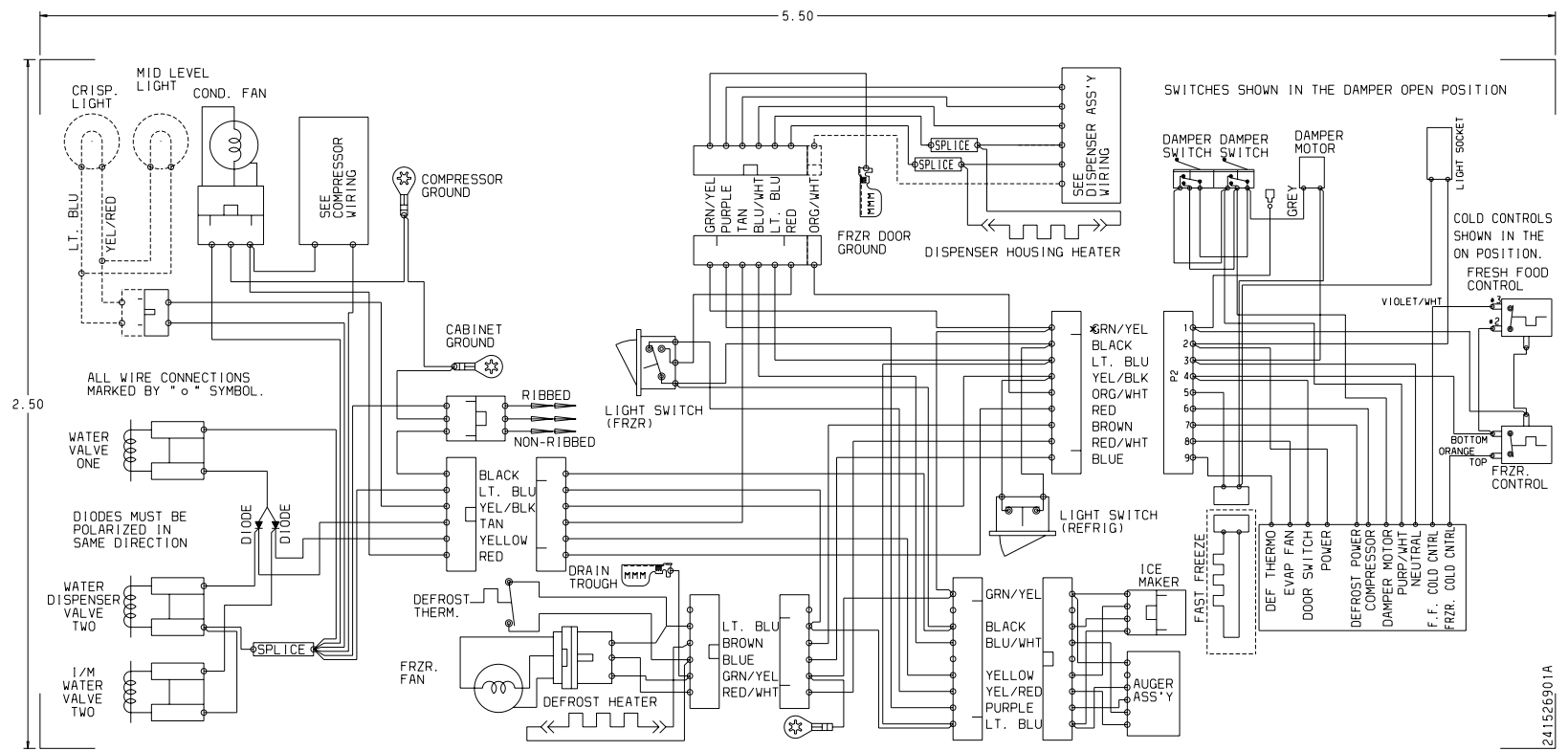

ELECTRONIC DISPENSER

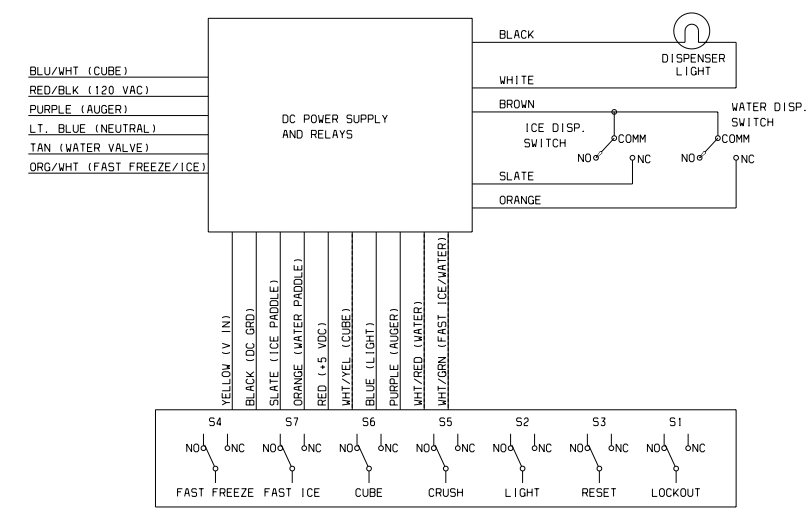

ELECTRO-MECHANICAL DISPENSER

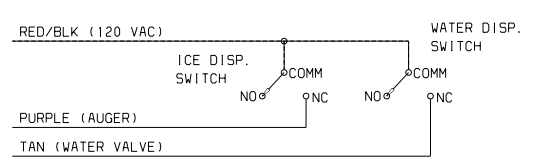

P.T.C. STARTER WITH RUN CAPACITOR

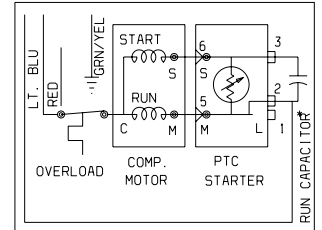

* CAPACITOR IS ONLY USED WITH SOME P. T. C. MODELS.

SERVICE PARTS	23 CUBIC FOOT		26 CUBIC FOOT	
	STANDARD	E-STAR	STANDARD	E-STAR
Compressor Kit *	5303918303	5303918299	5303918303	5303918298
Starter/PTC/TSD *	241524604	241527802	241524604	241527801
Run Capacitor *	218909913	218909915	218909913	218909915
Temp. Control-Ref	241507701	241507701	241507701	241507701
Temp. Control-Frzd	450226-07	450226-07	450226-07	450226-07
Timer (if applicable)	N/A	N/A	N/A	N/A
ADC (if applicable)	241508001	241508001	241508001	241508001
Defrost Heater Kit	5303918253	5303918253	5303918253	5303918253
Defrost Thermostat Kit	5303918214	5303918214	5303918214	5303918214
Evaporator Fan Motor	240369701	240369701	240369701	241537301
Condenser Fan Motor	240523601	241538001	240523601	241538001

* Typical compressor kit includes compressor, electrical components, and filter-drier