

Installation Instructions

	! WARNING
	<ul style="list-style-type: none">• ALL RANGES CAN TIP• INJURY TO PERSONS COULD RESULT• INSTALL ANTI-TIP DEVICE PACKED WITH RANGE• SEE INSTALLATION INSTRUCTIONS

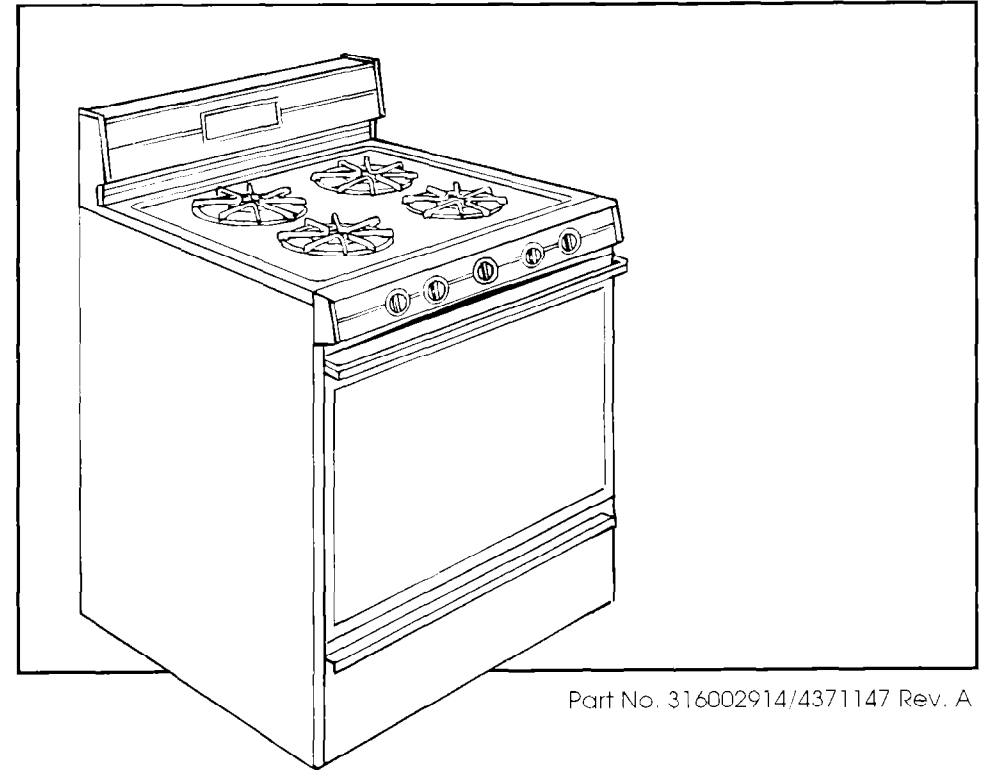

IMPORTANT:
Read and save
these instructions.

IMPORTANT:

Installer: Leave Installation Instructions with the homeowner.

Homeowner: Keep installation instructions for future reference.

Save Installation Instructions for local electrical inspector's use.

**30" Freestanding
Gas Range**

Before you start...

Proper installation is your responsibility. A qualified technician must install this range. Make sure you have everything necessary for correct installation. It is the responsibility of the installer to comply with the installation clearances specified on the serial/rating plate. The serial/rating plate is located under the maintop.

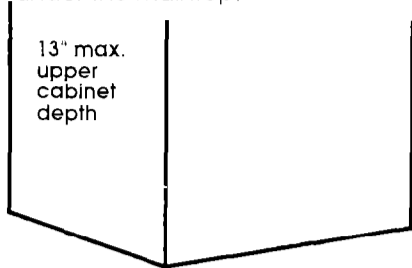

13" max. upper cabinet depth

18" min. clearance upper cabinet to countertop

30" min. opening width

1" min. countertop space to side wall or other combustible material.

Check location where range will be installed. The range should be located away from strong draft areas, such as windows, doors and strong heating vents or fans. The range should be located for convenient use in the kitchen. Recessed installations must provide complete enclosure of the sides and rear of range.

NOTE: Clearances specified are for combustible walls and materials that have a density of 20 or more pounds per cubic foot. No evaluation of clearances has been made for installation adjacent to materials that are less than 20 pounds per cu. ft. or to plastic tiles and sheeting.

Do Not pinch the power cord between the range and wall.

Grounded electrical outlet is required. See Electrical requirements.

Important: Observe all governing codes and ordinances.

* Note: 30" min. when bottom of wood or metal cabinet is protected by not less than 1/4" flame retardant millboard covered with not less than No.28 MSG sheet steel, 0.015" stainless steel, 0.024" aluminum or 0.020" copper.

36" min. clearance between the top of the cooking platform and the bottom of an unprotected wood or metal cabinet.

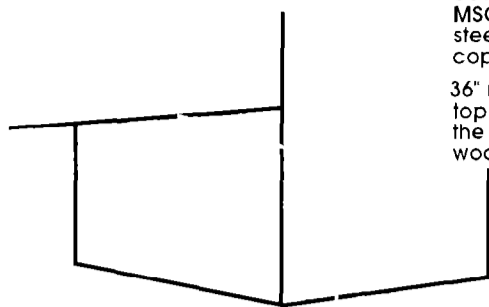

For minimum clearances, see Note.*

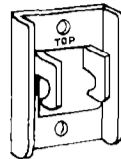

The anti-tip bracket **MUST** be installed. For detailed instructions, See Panel B.

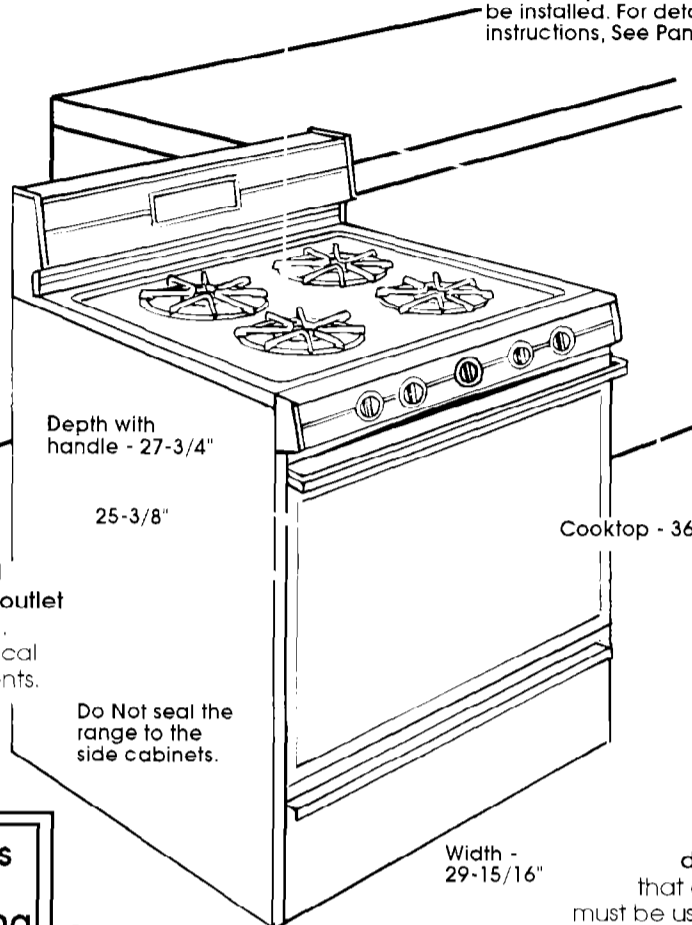

Proper gas supply connection must be available. See Gas supply requirements.

Width - 29-15/16"

ALL OPENINGS IN THE WALL OR FLOOR WHERE THE RANGE IS TO BE INSTALLED MUST BE SEALED.

Cabinet opening dimensions that are shown must be used. Given dimensions provide 0" clearance.

Overall - 46-1/4"

Cooktop - 36"

Do Not seal the range to the side cabinets.

Electrical and gas dimensions

Shaded area is recommended area for 120v outlet on rear wall and area for through-the-wall connection of gas pipe and shutoff valve.

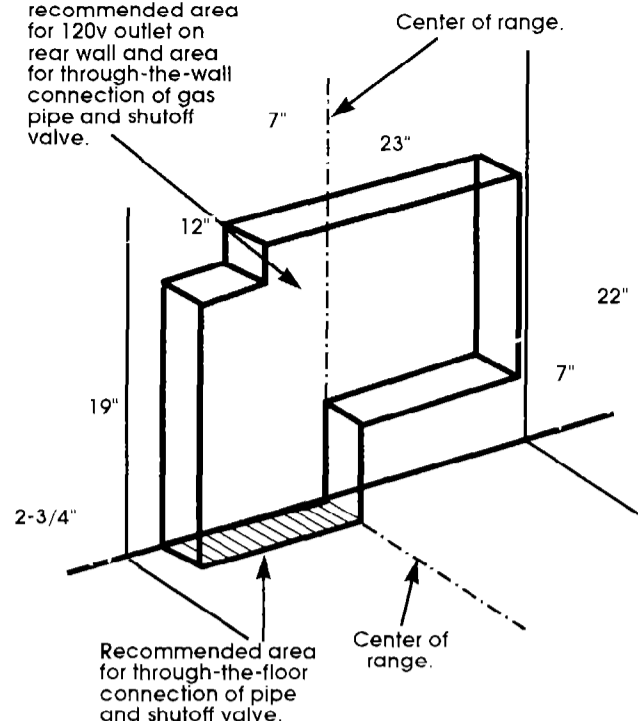

Recommended area for through-the-floor connection of pipe and shutoff valve.

Mobile Home Installation

The installation of this range must conform to the Manufactured Home Construction and Safety Standards, Title 24 CFR, Part 3280 (formerly the Federal Standard for Mobile Home Construction and Safety, Title 24, HUD Part 280) or when such standard is not applicable, the Standard for Manufactured Home Installation 1982 (Manufactured Home Sites, Communities and Setups), ANSI Z225.1-NFPA 501A, — latest edition, or with local codes.

When this range is installed in a mobile home, it must be secured to the floor. Any method of securing the range is adequate as long as it conforms to the standards listed above.

Copies of the standards listed may be obtained from:

* National Fire Protection Association
Batterymarch Park
Quincy, Massachusetts 02269

** American Gas Association
1515 Wilson Boulevard
Arlington, Virginia 22209

WARNING: If the information in this manual is not followed exactly, a fire or explosion may result causing property damage, personal injury or death.

- Do Not store or use gasoline or other flammable vapors and liquids in the vicinity of this or any other appliance.
- **WHAT TO DO IF YOU SMELL GAS**
 - Do Not try to light any appliance.
 - Do Not touch any electrical switch; Do Not use any phone in your building.
 - Immediately call your gas supplier from a neighbor's phone. Follow the gas supplier's instructions.
 - If you cannot reach your gas supplier, call the fire department.
- Installation and service must be performed by a qualified installer, service agency or the gas supplier.

CAUTION

Property Damage

- Contact a qualified floor covering installer to check that the floor covering can withstand heat at least 90°F above room temperature.
- Use an insulated pad or 1/4" plywood under range if installing range over carpeting.

Failure to do so may result in damage to floor covering.

Tools and materials needed for installation:

- gas line shutoff valve
- L.P.-resistant pipe-joint compound
- AGA design-certified flexible metal connector (4-5 feet)
- flare union adapter for connection to pressure regulator (1/2" NPT x 1/2" or 3/4" I.D.)
- hand or electric drill
- wood/metal wall stud: 1/8-inch drill bit
- concrete/concrete block walls: 3/16-inch carbide-tipped masonry drill bit

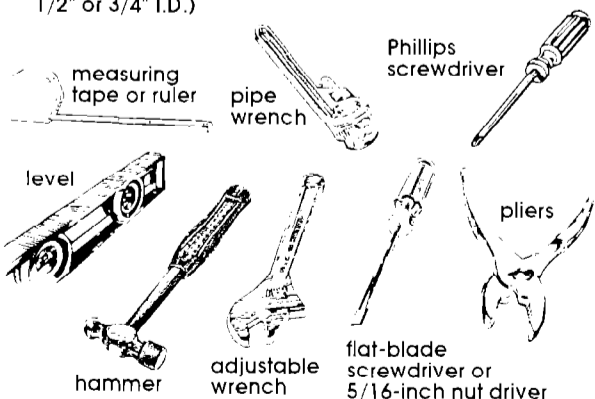

Parts supplied for installation:

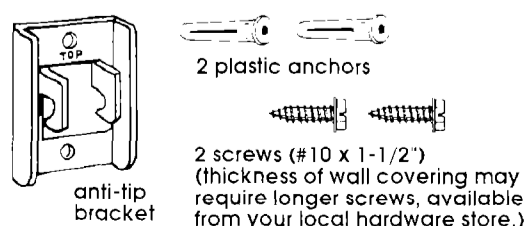

Gas supply requirements

Observe all governing codes and ordinances

WARNING

Fire Hazard

- Range must be connected to a regulated gas supply.
- L.P. gas supply must Not exceed a pressure of 14" water column. This must be checked by a qualified technician before installing the range.
- Do Not use an open flame to test for leaks from gas connections.
- New, A.G.A.-approved, flexible gas line should be used when codes permit.

Failure to follow these instructions could result in a fire, explosion or personal injury.

A. This installation must conform with local codes and ordinances. In the absence of local codes, installations must conform with American National Standard, National Fuel Gas Code ANSI Z223.1-latest edition.**

B. Input ratings shown on the serial/rating plate are for elevations up to 2,000 feet. For elevations above 2,000 feet, ratings should be reduced at a rate of 4% for each 1,000 feet above sea level.

C. This range is design-certified by A.G.A. for NATURAL and L.P. gases with appropriate conversion. The serial/rating plate located under the cooktop has information for the type of gas that can be used. If this information does not agree with the type of gas available, check with the local gas supplier. See Panel C and back cover for gas conversion instructions.

WARNING

Fire Hazard

Do Not obstruct the flow of combustion and ventilation air.

Personal Injury Hazard

Avoid installing cabinet storage above the cooking surface. If cabinets are already installed, reduce the hazard of reaching over a heated cooking surface by installing a range hood. The range hood should extend a minimum of 5 inches out from the bottom front of the cabinets.

Reaching over a heated cooking surface could result in a serious burn.

Electrical Shock Hazard

It is the customer's responsibility:

- To contact a qualified electrical installer.
- To assure that the electrical installation is adequate and in conformance with National Electrical Code, ANSI/NFPA 70-latest edition*, and all local codes and ordinances.

Failure to do so could result in electrical shock or other personal injury.

D. Provide a gas supply line of 3/4" rigid pipe to the range location. A smaller size pipe on long runs may result in insufficient gas supply. Pipe-joint compounds made for use with L.P. gas must be used. With L.P. gas, piping or tubing size can be 1/2" minimum. L.P. gas suppliers usually determine the size and materials used on the system.

E. If local codes permit, a new A.G.A. design-certified, 4 - 5 foot long, 1/2" or 3/4" I.D., flexible metal appliance connector is recommended for connecting this range to the gas supply line. Do Not kink or damage the flexible tubing when moving the range. A 1/2-inch male pipe thread is needed for connection to pressure regulator female pipe threads.

F. The supply line shall be equipped with an approved shutoff valve. This valve should be located in the same room as the range and should be in a location that allows ease of opening and closing. Do Not block access to shutoff valve.

G. If rigid pipe is used as a gas supply line, a combination of pipe fittings must be used to obtain an in-line connection to the range. All strains must be removed from the supply and fuel lines so range will be level and in line.

H. The regulator must be checked at a minimum of 1-inch water column above the set pressure. The inlet pressure to the regulator should be as follows for operation:

- NATURAL GAS:**
 Set pressure 5 inches
 Maximum pressure 14 inches
L.P. GAS:
 Set pressure 11 inches
 Maximum pressure 14 inches

I. Line pressure testing:
Testing above 1/2 lb psi (gauge)
 The range and its individual shutoff valve must be disconnected from the gas supply piping system during any pressure testing of that system at test pressures greater than 1/2 psig (3.5 kPa).

Testing at 1/2 lb psi (gauge)
 The range must be isolated from the gas supply piping system by closing its individual manual shutoff valve during any pressure testing of the gas supply piping system at test pressures equal to or less than 1/2 psig (3.5 kPa).

Electrical Requirements

WARNING

Electrical Shock Hazard

- Electrical ground is required on this appliance.
- Improper connection of the equipment-grounding conductor can result in fire, electrical shock, or other personal injury.
- Check with a qualified electrician if you are in doubt as to whether the appliance is properly grounded.
- Do Not modify the power supply cord plug. If it does not fit the outlet, have a proper outlet installed by a qualified electrician.
- Do Not use an extension cord with this appliance.
- Do Not have a fuse in the neutral or grounding circuit. A fuse in the neutral or grounding circuit could result in an electrical shock.

Failure to follow these instructions could result in a fire, electrical shock or other personal injury.

A 120-volt, 60-Hz, AC-only, 15-ampere, fused electrical supply is required. A time-delay fuse or circuit breaker is recommended. It is recommended that a separate circuit serving only this appliance be provided.

Electronic ignition systems operate within wide voltage limits, but proper grounding and polarity are necessary. In addition to checking that the outlet provides 120-volt power and is correctly grounded, the outlet must be checked by a qualified electrician to see if it is wired with correct polarity.

The wiring diagram is found on a separate sheet in the literature package. The wiring diagram can also be found on the back of the range.

Panel B

Recommended grounding method

DO NOT, UNDER ANY CIRCUMSTANCES, REMOVE THE POWER SUPPLY CORD GROUNDING PRONG.

For personal safety, this appliance is equipped with a power supply cord having a 3-prong grounding plug. To minimize possible shock hazard, the cord must be plugged into a mating 3-prong, grounding-type wall receptacle, grounded in accordance with the National Electrical Code, ANSI/NFPA 70-latest edition* and all local codes and ordinances. (See Figure 1.) If a mating wall receptacle is not available, it is the personal responsibility and obligation of the customer to have a properly grounded, 3-prong wall receptacle installed by a qualified electrician.

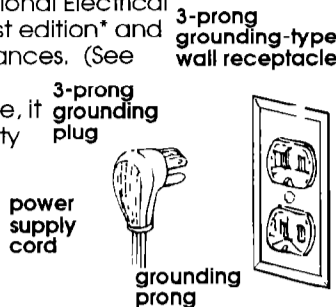

Now start... With range in kitchen.

1. Remove shipping materials, tape and protective film from range. Keep cardboard shipping base under range. Remove oven racks and shipping materials from inside oven.

2. Adjust the leveling legs to a point where the range base does not touch the floor.

WARNING



- To prevent tipping, install range anti-tip bracket.
- Anti-tip bracket must be attached to a wood or metal wall stud, or concrete or concrete block wall.
- Do Not attach anti-tip bracket to a cabinet.
- Save these Installation Instructions. If range is moved to a new location, the anti-tip bracket must be reinstalled in the new location.

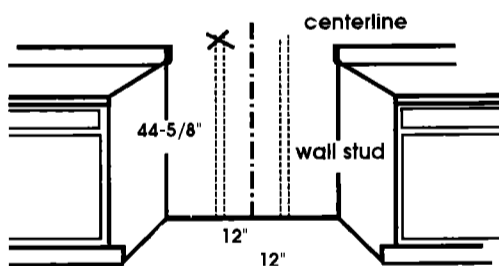

3. To mount anti-tip bracket to wood or metal wall stud: Find the wall stud that is closest to the center of the range location. (Note: Wall stud should Not be more than 12 inches to the right or left of center of range location.) Measure and mark at the center of the wall stud a distance of 44-5/8 inches up from the floor.

To mount anti-tip bracket to concrete or concrete block wall: Measure and mark on the rear wall at the center of the range location a distance 44-5/8 inches up from the floor. (Note: Anti-tip bracket may Not be installed more than 12 inches to the right or left of center of range location.)

WARNING

Electrical Shock Hazard

- Take special care when drilling holes into the wall. Electrical wires may be concealed behind the wall covering.
- Locate the electrical circuits that could be affected by the installation of this bracket and turn off the power to these circuits.

Failure to follow these instructions may result in electrical shock or other personal injury.

CAUTION

Property Damage

- Contact a qualified installer for the best procedure to drill mounting holes through the type of covering (i.e. ceramic tile) and into wall stud, concrete or concrete block wall.
- Before moving range across floor, check that range is on shipping base or slide range onto cardboard or hardboard. Failure to follow these instructions may result in damage to wall or floor covering.

4. Line up the "TOP" mounting hole on anti-tip bracket with mark on wall. Use a pencil to mark the location of the top and bottom mounting holes. Remove bracket. If wall covering is ceramic tile, drill a 3/16-inch hole through tile only. Then proceed as follows:

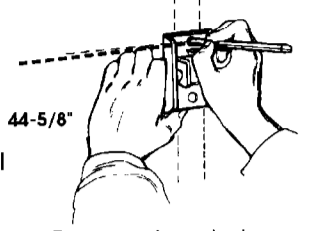

For wood or metal wall studs:

Drill 1/8-inch holes at each mounting hole location through wall and into stud.

For concrete or concrete block wall:

Drill 3/16-inch holes (1-3/4-inch minimum deep) at each mounting hole location. Tap plastic anchors into mounting holes with hammer.

5. Line up holes on bracket with holes on wall, making sure that the "TOP" mounting hole on bracket is lined up with top hole in wall. Securely fasten bracket to wall using screws provided.

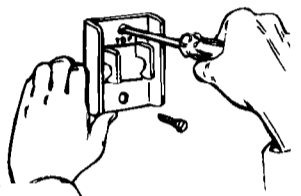

6. Plug range power supply cord into grounded outlet. Carefully slide range into position until range is approximately 2 inches from rear wall. Remove shipping base, cardboard or hardboard from under range.

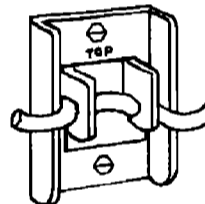

7. Push cable, located on rear of range, up and into the two hooks on the anti-tip bracket.

Check that cable is secure in both hooks by pulling cable towards range. If cable comes out of hooks, reposition cable to insure that cable fits securely in both anti-tip bracket hooks. Slide range into final position.

8. If installing the range in a mobile home, you MUST secure the range to the floor. Any method of securing the range is adequate as long as it conforms to the standards listed in the Mobile Home installation instructions, Panel A.

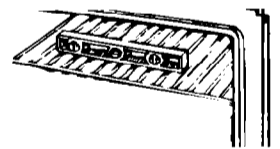

9. Place rack in oven. Place level on rack, first side to side; then front to back. If range is not level, adjust the leveling legs up or down until the range is level. Note: Oven must be level for satisfactory baking conditions.

WARNING

Fire Hazard

Do Not make connection too tight. The regulator is die cast. Overtightening may crack the regulator, resulting in a gas leak and possible fire or explosion.

All connections must be wrench-tightened.

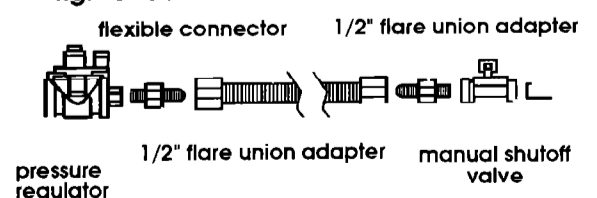

10. Assemble the flexible connector from the gas supply pipe to the pressure regulator, located in burner box, in this order: shutoff valve, 1/2" flare union adapter, flexible connector, 1/2" flare union adapter. Seal all openings in floor or wall wherever range is installed.

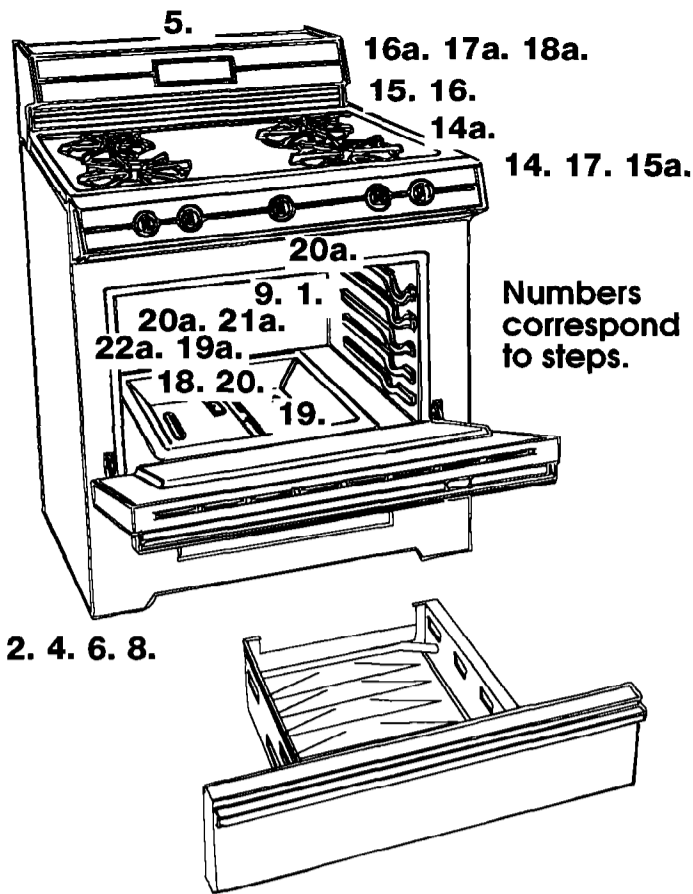

Numbers correspond to steps.

11. Use pipe-joint compound made for use with Natural and L.P. gas to seal all gas connections. If flexible connector is used, be certain connector is not kinked.

12. Open the shutoff valve in the gas supply line. Wait a few minutes for gas to move through the gas line.

WARNING

Fire Hazard

Do Not use an open flame to test for leaks from gas connections. Checking for leaks with a flame may result in a fire or explosion.

13. Use a brush and liquid detergent to test all gas connections for leaks. Bubbles around connections will indicate a leak. If a leak appears, shut off gas valve controls and adjust connections. Then check connections again. **NEVER TEST FOR GAS LEAKS WITH A MATCH OR OTHER FLAME.** Clean all detergent solution from range.

Initial lighting and gas flame adjustments depend on type of system - electronic ignition or standing pilot. Raise cooktop and check which system is available. Continue installation, following steps under the heading for this range's system.

Electronic Ignition System — initial lighting and gas flame adjustments.

Cooktop and oven burners use electronic igniters in place of standing pilots. When the cooktop control knob is turned to "LITE" position, the system creates a spark to light the burner. This sparking continues until the control knob is turned to the desired setting. When the oven control is turned to the desired setting, a glow bar heats up bright orange and ignites the gas. No sparking occurs and the glow bar remains on while the burner operates.

14. Check the operation of the cooktop burners. Push in and turn each control knob to "LITE" position. The flame should light within 4 seconds. **Do Not leave the knob in the "LITE" position after burner lights.**

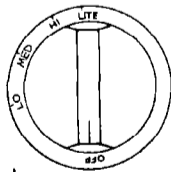

15. After burner lights, turn control knob to "HI" position. Check each cooktop burner for proper flame. The small inner cone should have a very distinct blue flame approximately 1/2" long. The outer cone is not as distinct as the inner cone.



16. If burners need adjusting for proper flame, remove burner grates and carefully lift up the maintop. Adjust the air shutter to the widest opening that will produce a sharp blue flame that does not lift or blow off of the burner. Repeat as necessary with each burner.

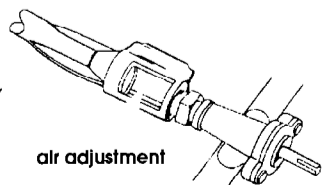

Panel C

17. Push in and turn the control knob to the "LITE" position and then to the "LO" position. The low flame should be a minimum, steady, blue flame. To adjust the burner, remove the control knob and turn the adjustment screw in the center of the valve stem. Check the adjustment by turning the control knob from "HI" to "LO" several times. The burner is properly adjusted when the low flame remains steady and the burner does not go out. Check each burner.

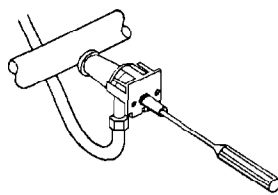

18. Remove oven rack. Remove oven screws at rear of oven bottom. Pull oven bottom rear up and remove front of oven bottom from oven front. Remove oven bottom. Remove burner baffle. Check the operation of the oven burner.

Push in and turn temperature control knob to 300°F. **The oven burner should light in 50 - 60 seconds. This delay is normal.** The oven safety valve requires a certain time before it will open and allow gas to flow.

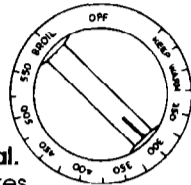

CAUTION

Product Damage

- Do Not insert any object into the openings of the protective shield that surrounds the ignitor.
 - Do Not clean the area.
- Failure to follow these instructions could result in product damage.

19. Check the oven burner for proper flame. This flame should have a 1" long inner cone of bluish-green, with an outer mantle of dark blue, and should be clean and soft in character. No yellow tips, blowing or lifting of flame should occur.



20. If oven flame needs to be adjusted, locate the air shutter near the center rear of the oven burner. Loosen screw and adjust the air shutter until the proper flame appears. Tighten screw.



21. Replace the oven burner baffle, oven bottom, and oven racks.

Standing Pilot System

14a. Be sure all control knobs are in the "OFF" position. Remove grates and raise the maintop.

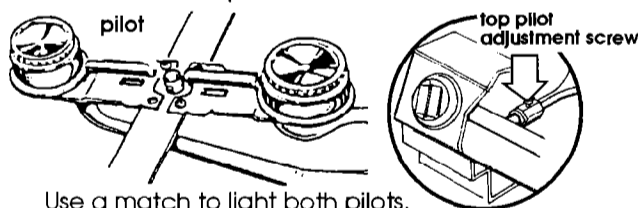

Use a match to light both pilots. Adjust pilot adjustment screw so pilot flame tip is 1/8" high and centered in the hole in the pilot housing. If the flame is too high, carbon (soot) will accumulate under the cooktop.

15a. Check the operation of the cooktop burners. Push in and turn each control knob to "LITE" position. The flame should light within 4 seconds. **Do Not leave the knob in the "LITE" position after burner lights.**

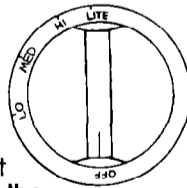

16a. After burner lights, turn control knob to "HI" position. Check each cooktop burner for proper flame. This small, inner cone should have a very distinct blue flame approximately 1/2" long. The outer cone is not as distinct as the inner cone.

17a. If burners need adjusting for proper flame, adjust the air shutter to the widest opening that will not cause the flame to lift or blow off of the burner. Repeat as necessary with each burner.

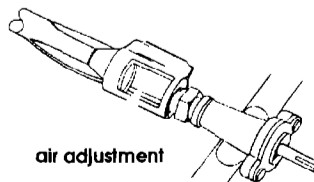

18a. Push in and turn the control knob to the "LITE" position and then to the "LO" position. The low flame should be a minimum, steady,

blue flame. To adjust the burner, remove the control knob and turn the adjustment screw in the center of the valve stem. Check the adjustment by turning the control knob from "HI" to "LO" several times. The burner is properly adjusted when the low flame remains steady and the burner does not go out. Check each burner.

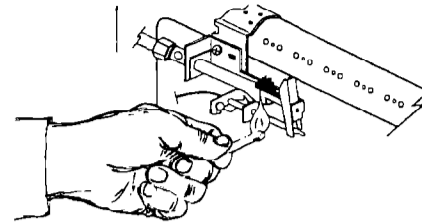

19a.

Make sure the oven control knob is in the

"OFF" position. Remove the oven racks, oven bottom, and oven burner baffle. Hold a lighted match to the opening in the top of the pilot at the rear of the oven burner. No pilot adjustments are required.

20a. Turn oven thermostat knob to 300°F. The oven pilot should now be larger with the flame extending down the slanted ramp and burning against a small metal bulb.

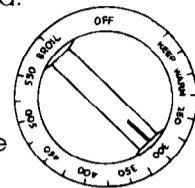

After 20-40 seconds, the main oven burner should ignite and burn until the oven temperature has reached 300°F. At that time, the oven pilot should get smaller, moving away from the metal bulb which will turn the main oven burner off after 20-40 seconds.

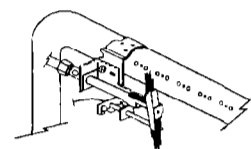

The oven burner will continue to turn off and on to maintain oven temperature.

21a. Check the oven burner for proper flame. This flame should be 1" long, with inner cone of bluish-green, and outer mantle of dark blue and should be clean and soft in character. No yellow tips, blowing or lifting of flame should occur.

22a. If oven flame needs to be adjusted, loosen screw and adjust the air shutter until the proper flame appears. Tighten screw. Replace burner baffle, oven bottom and oven racks.

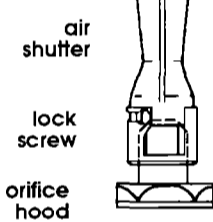

To get the most efficient use from your new range, read your Use and Care Guide. Keep Installation Instructions and Guide close to the range for easy reference.

Gas conversion

The serial rating plate, located under the maintop, specifies the type of gas this range was set to use. Conversion should be done by a qualified installer.

Natural to L.P. gas

Standing Pilot Models:

A. Convert the pressure regulator. Do Not remove the pressure regulator.

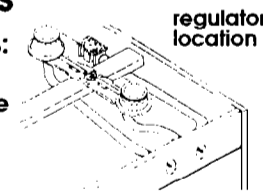

small end towards regulator for natural gas
enlarged end towards regulator for L.P. gas

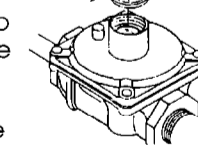

- Remove the cap from the pressure regulator.
- Remove the plunger from the cap.
- Turn the plunger upside down with the enlarged end down.
- Replace the plunger inside the regulator.
- Replace the cap.

Electric Ignition Models

A. Convert the pressure regulator. Do Not remove the pressure regulator.

hollow end towards regulator for natural gas
solid end towards regulator for L.P. gas

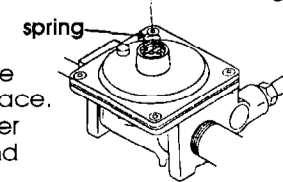

- Unscrew the cap from the pressure regulator. Be sure spring stays in place.
- Turn the cap over so the hollow end faces outward.
- Replace the cap of the regulator. The letters L.P. should be visible on exposed end of the cap.

B. Convert surface burner valves, (all models).

cooktop (shown in raised position)

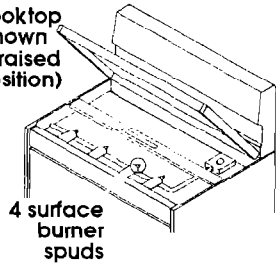

4 surface burner spuds

1. Lift and lock cooktop in up position.
2. Use 1/2" wrench to turn spud counterclockwise until snug (approximately 2-1/2 turns). Do Not overtighten.

pin



spud

NAT. GAS
increases gas
increases flame size
(preset at factory for natural gas)

L.P. GAS
decreases gas
decreases flame size

C. Convert oven burner (all models).

1. Remove bottom oven hold-down screws at rear of oven bottom. Pull up at rear, and remove front of oven bottom from oven front frame. Pull the oven bottom straight out of the oven. Remove burner baffle.
2. Use 1/2" wrench to turn down the spud (approximately 2-1/2 turns), until snug against the pin. Do Not overtighten.
3. Turn thermostat control knob to 300°F. The oven burner flame should be steady and approximately 1" long with no yellow or orange tips.

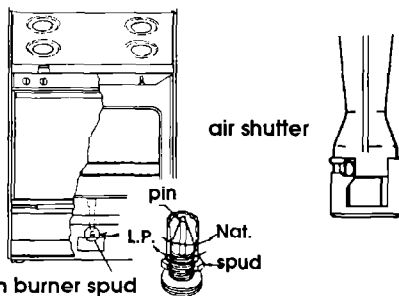

oven burner spud

4. If air shutter needs adjusting, loosen air shutter set screw and adjust to obtain proper flame. This will normally be completely open for L.P. gas. Tighten air shutter set screw.
5. Replace oven baffle and oven bottom.

Oven thermostat adjustment - Standing Pilot System only

If your range is connected to natural gas, the selector should be turned so the indicator points to the NAT position. If the range is connected to L.P. or bottled gas, the selector should be turned to the L.P. position.

Allow enough time for the air to escape from the pilot gas line.

Turn the oven thermostat knob to "Off".

Remove oven thermostat knob to gain access to selector key. Light the pilot light.

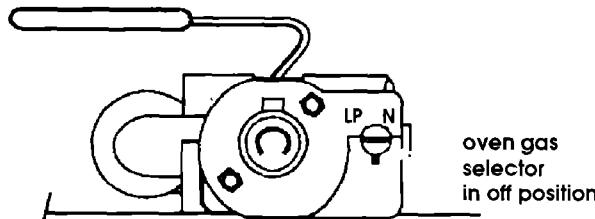

L.P. to Natural gas

Converting to natural gas should be done by a qualified installer.

Use a wrench to remove cap from pressure regulator. Turn cap over so that the "Nat." side is up and replace cap and gasket on regulator.

Cooktop orifice hoods and oven orifice hood need to be loosened 2 to 2-1/2 turns to allow for proper gas flow. The flame adjustment for cooktop burners and oven burner would be the same as described in the installation steps (see Panel C). If you have a standing pilot system, remove thermostat knob and use a screwdriver to rotate key to "N" position. Replace thermostat knob.

For cleaning and maintenance...

If removing the range is necessary for cleaning or maintenance, shut off gas supply to the range. Disconnect the gas and electric supply.

If the gas or electrical supply is inaccessible, lift the range slightly at the front and pull the range out away from the wall. Pull the range out only as far as necessary to disconnect the gas and electric supply lines.

Remove the range to complete cleaning or maintenance.

Move range back into operating position. Level the range. Connect gas line to range and check for leaks. Make sure that cable is secure in anti-tip bracket. Plug electric power supply cord into outlet.

! WARNING

Personal Injury Hazard

Do Not step, lean or sit on the range or the door or drawers of the range.

Failure to follow this instruction could result in personal injury and/or product damage.

If you need assistance...

Check your Use and Care Guide for a toll-free number to call or call the dealer from whom you purchased this appliance. The dealer is listed in the Yellow Pages of your phone directory under "Appliances — Major."

When you call, you will need the range model number and serial number. Both numbers can be found on the serial/rating plate located under the maintop.