

---

# use & care guide

---

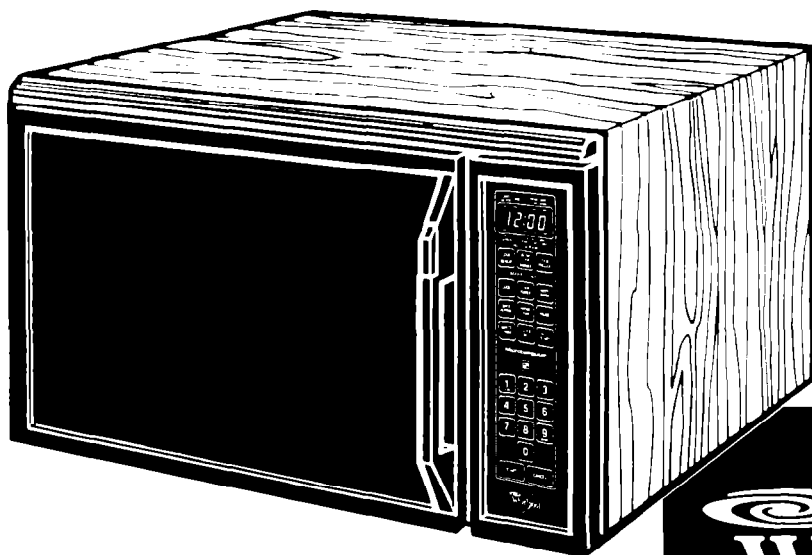

**MICROWAVE  
OVEN**



**Models MW8900XS  
MW8901XS**

---

s. Freezers. Refrigerator-Freezers. Ice Makers. Dishwashers. Built-In Ovens and Surface Units. Ranges. Microwave Ovens. Trash Compactors. Room Air Conditioners. Dehumidifi

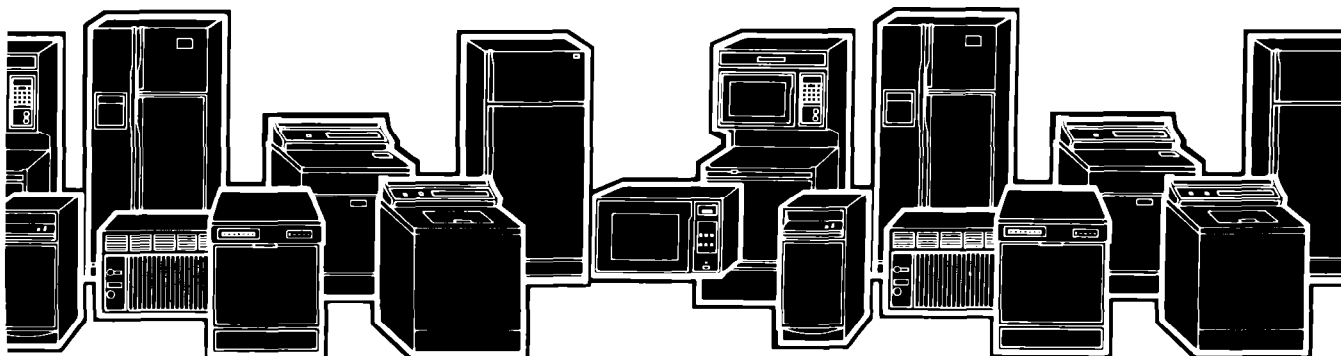

# Contents

	Page		Page
<b>Parts and Features</b>	2	Cooking Automatically After Defrosting	16
<b>Before You Install Your Microwave Oven</b>	3	Cooking with the Temperature Probe	18
<b>Before You Use Your Microwave Oven</b>	3	Using PAUSE	21
<b>Precautions to Avoid Possible Exposure to Excessive Microwave Energy</b>	3	Using KEEP WARM	23
<b>Important Safety Instructions</b>	4	Using AUTO START	24
<b>Using Your Microwave Oven</b>	5	Other Operating Hints	26
Microwave Oven Controls	5	Bi-Level Cooking Rack	27
Audible Signals	6	<b>Installation Instructions</b>	28
Setting the Clock	6	Grounding Instructions	29
Using the Minute Timer	7	Building in Your Microwave Oven	30
Cooking in Your Microwave Oven	8	<b>Caring for Your Microwave Oven</b>	31
Using AUTO SENSOR	8	Cleaning the Microwave Oven	31
Cooking at High Cook Power	12	Replacing the Light Bulb	31
Cooking at Lower Cook Powers	13	<b>How Your Microwave Works</b>	32
Defrosting	15	<b>Operating Safety Precautions</b>	33
		<b>If You Need Service or Assistance</b>	35
		<b>Microwave Oven Warranty</b>	36

©1989 Whirlpool Corporation

## Parts and features

**Models MW8900XS  
MW8901XS**

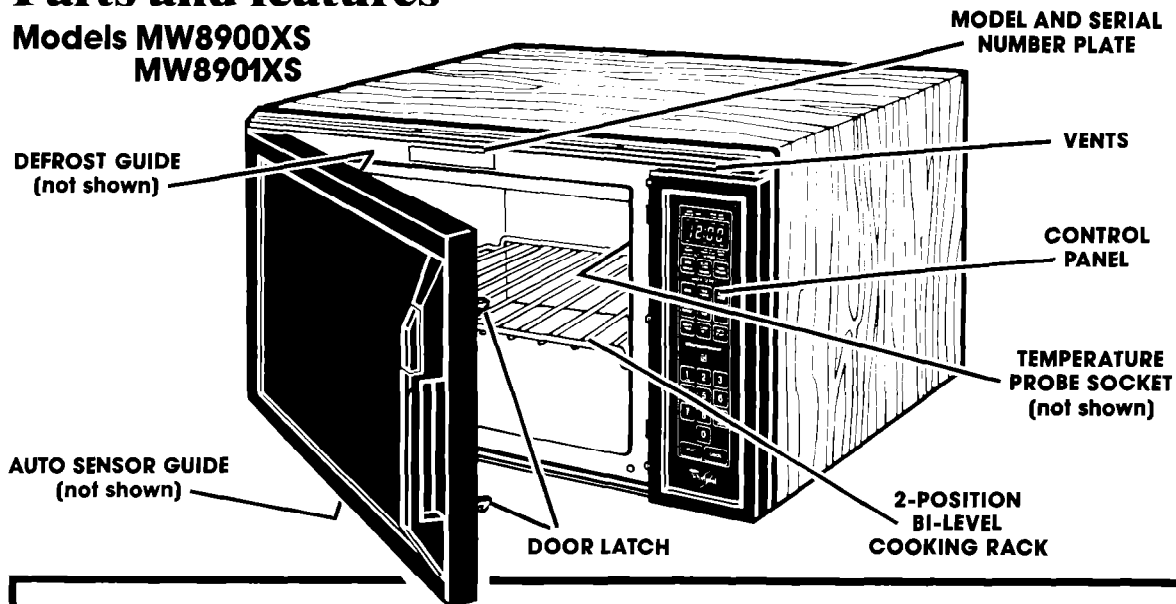

**Thank you for buying a Whirlpool appliance. Please complete and mail the Owner Registration Card provided with this product.** Then complete the form below. Have this information ready if you need service or call with a question.

- Copy model and serial numbers from plate (behind the microwave oven door on the oven frame) and the purchase date from the sales slip.
- Keep this book and your sales slip together in a handy place.

\_\_\_\_\_

**Model Number**

\_\_\_\_\_

**Serial Number**

\_\_\_\_\_

**Purchase Date**

\_\_\_\_\_

**Service Company Phone Number**

**Fill out and return the Microwave Registration Card included with your oven.** If the card is missing, please send the model number and serial number of your microwave oven with your name and address to...

Whirlpool Corporation  
Microwave Registration Department  
Administrative Center  
2000 M-63  
Benton Harbor, Michigan 49022

This information will help us reach you if there is ever a need to pass along information about your microwave oven.

## Before you install your microwave oven

**Read and carefully follow the "Installation Instructions" found on page 28 of this Use & Care Guide.**

### **⚠ WARNING**

#### **Personal Injury Hazard**

**Failure to follow the Installation Instructions could lead to product malfunction or personal injury.**

## Before you use your microwave oven

Read this Use & Care Guide carefully for important use and safety information. Store in a convenient place for future use.

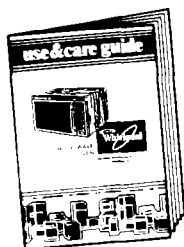

#### **It is your responsibility to be sure your microwave oven:**

- Has been installed where it is protected from the weather. **The microwave oven should be at a temperature above 50°F (10°C) for proper operation.** (See "Installation Instructions" found on page 28.)
- Has been installed on a surface strong enough to support its weight.
- Has been properly connected and grounded to electrical supply. (See "Installation Instructions" found on page 28.)
- Is not used by children or anyone unable to operate it properly.
- Is properly maintained.
- Is used only for jobs expected of a home microwave oven.

## PRECAUTIONS TO AVOID POSSIBLE EXPOSURE TO EXCESSIVE MICROWAVE ENERGY...

**DO NOT** attempt to operate this oven with the door open since open-door operation can result in harmful exposure to microwave energy. It is important not to defeat or tamper with the safety interlocks.

**DO NOT** place any object between the oven front face and the door or allow soil or cleaner residue to accumulate on sealing surfaces.

**DO NOT** operate the oven if it is damaged. It is particularly important that the oven door close properly and that there is no damage to the

- (1) Door (bent),
- (2) Hinges and latches (broken or loosened),
- (3) Door seals and sealing surfaces.

**DO NOT** operate the microwave oven if the door window is broken.

The microwave oven should be checked for microwave leakage by qualified service personnel after a repair is made.

The oven should not be adjusted or repaired by anyone except properly qualified service personnel.

**DO NOT** operate the microwave oven with the outer cabinet removed.

# IMPORTANT SAFETY INSTRUCTIONS

Microwave ovens have been thoroughly tested for safe and efficient operation. However, as with any appliance, there are special installation and safety precautions which must be followed to ensure safe and satisfactory operation and prevent damage to the unit.

## **⚠ WARNING**

To reduce the risk of fire, electrical shock, injury to persons, or damage when using the microwave oven, follow basic precautions, including the following:

- 1.** Read all instructions before using appliance.
- 2.** Read and follow the specific "PRECAUTIONS TO AVOID POSSIBLE EXPOSURE TO EXCESSIVE MICROWAVE ENERGY" found on page 3.
- 3.** This appliance must be grounded. Connect only to properly grounded outlet. See "GROUNDING INSTRUCTIONS" found on page 29.
- 4.** Install or locate this appliance only in accordance with the provided "Installation Instructions" found on page 28.
- 5.** Do not store the metal cooking rack in the oven.
- 6.** Some products such as whole eggs and sealed containers – for example, closed glass jars – may explode and should not be heated in this oven.
- 7.** Use this appliance only for its intended use as described in this manual.
- 8.** As with any appliance, close supervision is necessary when used by children.
- 9.** Do not operate this appliance if it has a damaged cord or plug, if it is not working properly, or if it has been damaged or dropped. Electric shock, fire or other hazards may result.
- 10.** This appliance should be serviced only by qualified service personnel. Call a Whirlpool authorized TECH-CARE<sup>®</sup> Service Company for examination, repair or adjustment.
- 11.** Do not cover or block any opening on the appliance, fire may result.
- 12.** Do not use outdoors, damage to the oven or electric shock may result.
- 13.** Do not immerse cord or plug in water, electric shock may result.
- 14.** Keep cord away from heated surfaces, electric shock may result.
- 15.** Do not let cord hang over edge of table or counter, electric shock may result.
- 16.** Follow door surface and interior cleaning instructions on page 31.
- 17.** To reduce the risk of fire in the oven cavity:
  - a. Do not overcook food. Carefully attend appliance if paper, plastic, or other combustible materials are placed inside the oven to facilitate cooking. Paper can char or burn, and some plastics can melt if used when heating foods.
  - b. Do not deep fry in oven.
  - c. Test dinnerware or cookware before using. See page 34. Some dishes (melamine, Centura,<sup>®</sup> etc.) absorb microwave energy, becoming too hot to handle and slowing cooking times. Remove wire twist-ties from paper or plastic bags before placing bag in oven. Cooking in metal containers can damage the oven. So can containers with hidden metal (twist-ties, foil lining, staples, metallic glaze or trim.)
  - d. If materials inside the oven should ignite, keep oven door closed, turn oven off, and disconnect the power cord, or shut off power at the fuse or circuit breaker panel.
- 18.** Read and follow "OPERATING SAFETY PRECAUTIONS" starting on page 33.

## SAVE THESE INSTRUCTIONS

# Using your microwave oven

## Microwave Oven Controls

- There are three parts in the control section:
- The Digital Display/Clock, and Indicator Lights
  - Command Pads
  - Number Pads

Instructions for each control are covered on the following pages. Read them carefully.

When you first plug in the oven, a tone sounds and the Display will show 88:88. If after you set the Clock (page 6), the Display again shows all 8's; your electricity was off for a while. Reset the Clock.



## Digital Display/Clock and Indicator Lights

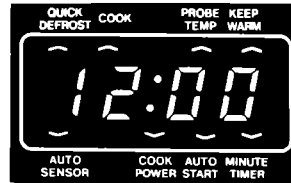

When you are not using the microwave oven, this is an accurate Digital Clock. When you are using the microwave oven, it displays time settings, temperature settings and Indicator Lights.

## Command Pads



Touch Command Pads to tell the microwave oven what to do and in what order. A few examples:

- CLOCK SET tells the oven you are going to set the Clock.
- START tells the oven to start.

See page 6 for information on the tone you hear when touching any pad.

Each Command Pad, (except START, CANCEL and CLOCK SET) lights an Indicator Light on the Digital Display. The Indicator Light comes on when you touch the Command Pad.

While the oven is running, an Indicator Light (or lights) will be on to show what the oven is doing.

## Number Pads

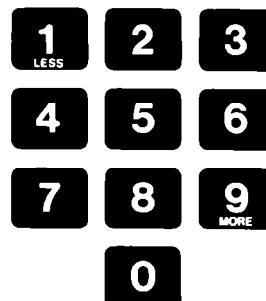

Once you've touched a Command Pad to tell the oven what you want it to do, you'll touch Number Pads to tell it...

- a time,
- a Cook Power,
- a food setting.

## Audible Signals

Audible signals are available to guide you when setting and using your oven. (A programming tone will sound each time you touch a pad. Two beeps will sound between cycles. A reminder tone will sound every 60 seconds after cooking is done to remind you that something has been left in the oven. A 3 second tone signals the end of the Minute Timer function.) If you don't hear a tone, it is because of incorrectly entered instructions or because the tones have been removed. For example, a tone will not sound if you touch a Number Pad before you touch a Command Pad.

### To remove the programming tone and reminder tone:

- Open the door.
- Touch CANCEL **twice**, then touch START.
- Programming and reminder tones will be cancelled.

### To replace the tones:

- Repeat the steps above.

### To remove all tones, except the Minute Timer signal:

- Open the door.
- Touch CANCEL **twice**, touch 0, then touch START.
- All audible tones (except Minute Timer signal) will be cancelled.

### To replace the tones:

- Repeat the steps above.

**NOTE: If your electricity goes off, the tones will be replaced when the electricity comes back on.**

## Setting the Clock

When the oven is first plugged in, a tone sounds and the Display shows "88:88" If the electric power ever goes off, the Display will again show all 8's when the power comes back on.

You can cook or use the Minute Timer without setting the Clock, but the Display will be blank after cooking.

### DO THIS...



1. Touch **CLOCK SET**.

### THIS HAPPENS...

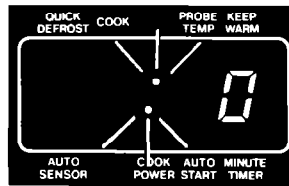

The Display will show a "0" and the colon will start to flash. **The first Number Pad must be touched within 5 seconds or the Display will go blank.** Touch CLOCK SET again and continue.



2. Touch Number Pads for the correct time of day.

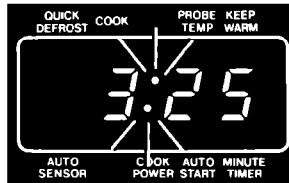

The Display will show what numbers you touched **in the order you touched them**. This example shows 3:25.



3. Touch **START**.



The colon will stop flashing. The Clock is set.



If you have touched in an incorrect time, such as 12:65, "Err" will show on the Display. Touch CLOCK SET and start over.

**NOTE: To reset the clock, touch CLOCK SET. The current time will show on the Display and the colon will flash. Continue to set the clock as shown above.**

## Using the Minute Timer

The Minute Timer does not start or stop cooking. It can be used alone or while the oven is operating. It works like a kitchen timer.

### DO THIS...

### THIS HAPPENS...



1. Touch MINUTE TIMER.

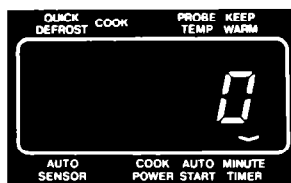

The MINUTE TIMER Indicator Light will come on and the Display will show a "0." **The first Number Pad must be touched within 5 seconds or the Display will again show the time of day.** Touch MINUTE TIMER again and continue.



2. Touch Number Pads for minutes and seconds.



The Display will show what numbers you touched **in the order you touched them**. This example shows 1 minute, 45 seconds.



3. Touch START.



The MINUTE TIMER Indicator Light will stay on to show that the Minute Timer is running.

The Display counts down the seconds to show how much time is left on the Minute Timer.

When the set time is up, a 3 second signal will sound and the Display will show the time of day.

## Changing the Minute Timer

- Touch MINUTE TIMER.
  - Touch numbers to set new time.
  - Touch START.
- New instructions cancel the old ones.**

## Cancelling the Minute Timer

- Touch MINUTE TIMER.
- Touch CANCEL. **Note.** Touch MINUTE TIMER before touching CANCEL to cancel just the Minute Timer. **If CANCEL is touched first, all cooking instructions will be cancelled and the Minute Timer will continue to operate.**

The Minute Timer can be set to time other activities while the oven is operating in any other cycle. The Display will countdown the time of the cycle in operation. The Minute Timer will continue to countdown, but will not show on the Display. When the time is up, a 3 second signal will sound.

Opening the oven door does not stop the Minute Timer countdown; however, it does stop any cooking or defrosting. Close the door and touch START to continue cooking or defrosting.

## Cooking in Your Microwave Oven

Be sure to read the MICRO MENUS<sup>®</sup> Cookbook packed with the microwave oven. It contains information about:

- What microwave energy is.
- How food is cooked by microwave energy.
- What affects cooking speed and cooking evenness.
- Safety tips.
- Utensils to use when cooking in a microwave oven.
- Cooking times for different foods.

### Important things to remember to get the best cooking results.

- ALWAYS cook food for the minimum recommended cooking time. If necessary, add time in one or two minute periods, then check for doneness to avoid overcooking the food.
- Stir, turn or rearrange the food being cooked about halfway through the cooking time for most even doneness with all recipes.
- If a glass cover is not available, use waxpaper, paper towels or microwave approved plastic wrap. Turn back a corner to vent steam during cooking.

## Using AUTO SENSOR

The AUTO SENSOR control allows you to cook food in the oven without computing time or power level. All foods give off moisture, aroma and other vapors as they cook. When the oven senses the right amount of vapor from the food, it will automatically determine the remaining time and power needed to finish cooking the food. You only need to touch COOK/REHEAT or COOK FROZEN and a number pad (for a food setting), then START. For Slow Cook/Simmer, touch SLOW COOK/SIMMER, then START. If you like your food less done than average you may decrease the cooking time by touching the "LESS" (Number 1) Pad after selecting the category (before touching START). If you like your food more done than average, touch the "MORE" (Number 9) Pad after selecting the category (before touching START) to extend the time. You may add ingredients, stir, turn or rotate during the **timed** portion of the Auto Sensor cycles. However, "Err" will show on the Display if the door is opened during the first (automatic) part of either cycle. If this happens, open the door and touch CANCEL. To finish cooking, estimate the remaining time and reset the oven using the Cook cycle. **Do not reset the Auto Sensor.** See the AUTO SENSOR chart included with your oven and the AUTO SENSOR guide on the inner door panel for examples of food to cook at each setting.

## COOK/REHEAT

Use COOK/REHEAT to automatically cook **fresh** food items or **reheat** previously cooked foods. There are 9 cooking categories in COOK/REHEAT.

### DO THIS...

1. Put food in the oven and close the door.



2. Touch COOK/REHEAT.

### THIS HAPPENS...

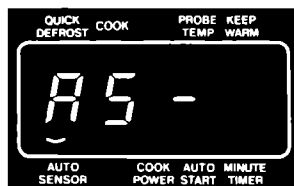

The AUTO SENSOR Indicator Light will come on and the Display will show "AS-".



**2**

**3. Touch a Number Pad (1-9) for the cooking category you want. (See guide on inner door panel and separate AUTO SENSOR chart.)**



The Display will show the AUTO SENSOR setting you touched. This example shows you selected category 2.

**1**  
LESS

**9**  
MORE

**4. Touch LESS (1) or MORE (9) if desired. (Option: Skip to Step 5 if you do not wish to shorten or lengthen cooking time.)**



The Display will not change.

**START**

**5. Touch START.**



The oven automatically cooks at a pre-set Cook Power for that setting. The AUTO SENSOR Indicator Light will stay on to show that the oven is cooking the food. **Do not open the oven door during this part of the cycle.**



When you hear 2 beeps, the Display will show and count down the remaining cooking time (except at setting Number 1). The oven door can now be opened, if needed to stir, turn or rearrange food.



BEEP BEEP BEEP BEEP

When the cooking time ends, "End" will show on the Display and 4 beeps will sound. (You can stop the beeping by opening the door or by touching CANCEL.) "End" will remain on the Display and a reminder tone will sound every 60 seconds until the door is opened or CANCEL is touched. The Display will then show the time of day.

## COOK FROZEN

Use COOK FROZEN to automatically cook **frozen** food items. There are five cooking categories in COOK FROZEN.

### DO THIS...

**1. Put frozen food in the oven and close the door.**

### THIS HAPPENS...

continued on next page

## DO THIS...



2. Touch COOK FROZEN.



3. Touch a Number Pad (1-5) for the frozen food cooking category you want. (See guide on inner door panel and separate AUTO SENSOR chart.)



4. Touch LESS (1) or MORE (9) if desired. (Option: Skip to Step 5 if you do not wish to shorten or lengthen cooking time.)



5. Touch START.

## THIS HAPPENS...

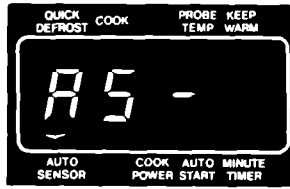

The AUTO SENSOR Indicator Light will come on and the Display will show "AS-".

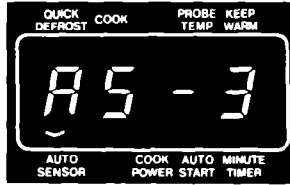

The Display will show the AUTO SENSOR category you touched. This example shows you selected setting 3.

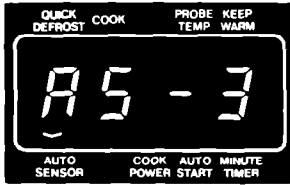

The Display will not change.



The oven automatically thaws and cooks at a pre-set Cook Power for that setting. AS-3 will show on the Display and the AUTO SENSOR Indicator Light will stay on to show that the oven is cooking the food. **Do not open the oven door during this part of the cycle.**



When you hear 2 beeps, the Display will show and count down the remaining cooking time (except at setting Number 1). The oven door can now be opened, if needed to stir, turn or arrange food.



BEEP BEEP BEEP BEEP

When cooking time ends, "End" will show on the Display and 4 beeps will sound. (You can stop the beeping by opening the door or by touching CANCEL.) "End" will remain on the Display and a reminder tone will sound every 60 seconds until the door is opened or CANCEL is touched. The Display will then show the time of day.

## SLOW COOK/SIMMER

Use SLOW COOK/SIMMER as you would a slow cooker to enhance flavor and tenderize less expensive cuts of meat. If you find that food needs a longer cooking time than the setting allows, you may extend future cooking times. To extend cooking time, touch SLOW COOK/SIMMER followed by MORE (Number 9) Pad and START. The LESS (Number 1) Pad cannot be used in this cycle.

KEEP WARM will automatically follow the cooking time in SLOW COOK/SIMMER. (See "Using KEEP WARM" on page 23.) Combined cooking time and KEEP WARM will equal 11 hours, 59 minutes unless cancelled any time after cooking is done.

### DO THIS...

### THIS HAPPENS...

1. Put food in the oven and close the door.



2. Touch SLOW COOK/SIMMER.



The AUTO SENSOR Indicator Light will come on and the Display will show "SL-C".



3. Touch MORE (9) if you wish to extend the cooking time.



The Display will not change.



4. Touch START.



The oven will automatically cook and simmer at different pre-set Cook Powers. The AUTO SENSOR Indicator Light will stay on to show that the oven is cooking the food. **Do not open the oven door during this part of the cycle.**

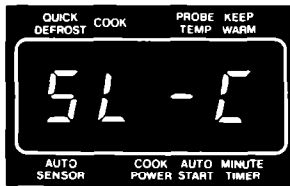

When you hear 2 beeps, the AUTO SENSOR Indicator Light will go off. This tells you the door can be opened to stir or turn food, or add ingredients.



When the food is done, you will hear 4 beeps and the oven will automatically go into KEEP WARM for the remainder of the 11 hours, 59 minutes total time. The KEEP WARM Indicator Light will come on and SL-C will continue to be displayed. Food is ready to serve anytime after KEEP WARM Indicator Light is on.

When SLOW COOK/SIMMER ends, "End" will show on the Display and 4 beeps will sound. (You can stop the beeping by opening the door or by touching CANCEL.) "End" will remain on the Display and a reminder tone will sound every 60 seconds until the door is opened or CANCEL is touched. The Display will then show the time of day.

**NOTE:** If food is removed from oven during KEEP WARM, touch KEEP WARM then CANCEL to cancel remainder of the time.

### AUTO SENSOR operating hints

- ALL AUTO SENSOR cooking categories have pre-set Cook Powers.
- The COOK POWER Indicator Light does not come on during AUTO SENSOR Cycles.
- No Cook or Temperature cycles can be used with AUTO SENSOR Cycles.
- Auto Start may be used with AUTO SENSOR Cycles.
- Quick Defrost and Keep Warm may be selected with Cook/Reheat or Cook Frozen **only**. Keep Warm is automatic at the end of Slow/Cook/Simmer cycle.
- Pause may be used with Cook/Reheat or Cook Frozen **only**. It will stop the oven between the first and second part of the cycle. See "Using PAUSE," page 20.
- In Cook/Reheat and Cook Frozen "AS-#" will show on the Display until the oven calculates and begins counting down the remaining cooking time, except "AS-1" which stops after the first part of the cooking cycle.
- The AUTO SENSOR Indicator Light goes off at the end of the first part of the Slow Cook/Simmer cycle.
- "Err" will show on the Display if the door is opened during the first part of any AUTO SENSOR cycle. "Err" will also show on the Display if AUTO SENSOR malfunctions. Open the door and touch CANCEL to clear the Display. **Do not reset AUTO SENSOR.** The food may over or undercook. To finish cooking food, estimate the remaining cooking time. Reset the oven using the COOK cycle and approximate Cook Power setting.

### Cooking at High Cook Power

#### DO THIS...

#### THIS HAPPENS...

1. Put food in the oven and close the door.



The COOK Indicator Light will come on and the Display will show four 0's.

2. Touch COOK.



The Display will show the numbers you touched **in the order you touched them**. The example shows 1 minute, 30 seconds.

3. Touch Number Pads for the cooking time you want.



**4. Touch START.**



**The oven will automatically cook at high Cook Power.**

The COOK Indicator Light will stay on to show that the oven is cooking.

count  
down

The Display counts down the time to show how much time is left in the first cycle.



BEEP BEEP BEEP BEEP

When the cooking time ends, "End" will show on the Display and 4 beeps will sound. (You can stop the beeping by opening the door or by touching CANCEL.) "End" will remain on the Display and a reminder tone will sound every 60 seconds until the door is opened or CANCEL is touched. The Display will then show the time of day.

**Changing the Cooking Time (In-use Reprogramming)**

Cooking time can be changed any time before touching START or during the cycle:

1. Touch COOK.
2. Touch numbers for the new time.
3. Touch START.

Cook will continue cooking for the new time.

**Cooking at Lower Cook Powers**

For best results, some recipes call for lower Cook Powers. The lower the Cook Power, the slower the cooking. Each Number Pad also stands for a different percentage of Cook Power. Many recipes in your MICRO MENUS<sup>®</sup> Cookbook tell you, by number, which Cook Power to use. Recipes in other books and magazines may tell you by name (HI, MED, LO, etc.) or percentage (10%, 50%, 80%, etc.).

The following chart gives the percentage of Cook Power each Number Pad stands for, and Cook Power name usually used.

automatic 100% of full power HIGH	4 = 40% of full power
9 = 90% of full power	3 = 30% of full power MED-LOW
8 = 80% of full power	2 = 20% of full power
7 = 70% of full power MED-HIGH	1 = 10% of full power LOW
6 = 60% of full power	0 = no power (fan and light will be off)
5 = 50% of full power MED	

**DO THIS...**

**THIS HAPPENS...**

- 1. Put food in the oven and close the door.**



- 2. Touch COOK.**



The COOK Indicator Light will come on and the Display will show four 0's.

continued on next page

7 3 0

3. Touch Number Pads for the cooking time you want.



The Display will show the numbers you touched **in the order you touched them**. This example shows 7 minutes, 30 seconds.

COOK POWER

4. Touch COOK POWER.

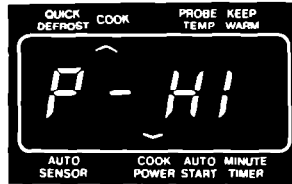

The COOK POWER Indicator Light will come on and the Display will show "P-HI". This shows the oven is preprogrammed to cook at full (HIGH) power.

5

5. Touch a Number Pad for the Cook Power you want.

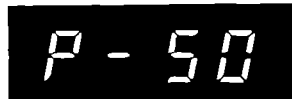

The Display will show what you touched. This example shows you touched Number Pad 5 for 50% of full power.

START

6. Touch START.

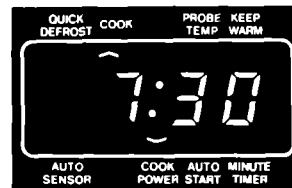

The COOK and COOK POWER Indicator Lights will stay on to show that the oven is cooking at a Cook Power other than HIGH.

count down

The Display counts down the time to show how much cooking time is left in the first cycle.

End

BEEP BEEP BEEP BEEP

When the cooking time ends, "End" will show on the Display and 4 beeps will sound. (You can stop the beeping by opening the door or by touching CANCEL.) "End" will remain on the Display and a reminder tone will sound every 60 seconds until the door is opened or CANCEL is touched. The Display will then show the time of day.

## Changing the Cook Power

The **Cook Power** can be changed any time before touching START or during the cycle.

- Touch COOK POWER.
  - Touch a number for the new Cook Power.
  - Touch START. The cycle will cook at the new Cook Power for the original time.
- OR...**
- Touch COOK POWER **twice** if you want to change a lower Cook Power to HIGH.
  - Touch START.

## Defrosting

Use QUICK DEFROST to thaw frozen food before cooking. For suggested defrost times, see the guide behind the oven door or in your MICRO MENUS<sup>®</sup> cookbook.

### DO THIS...

### THIS HAPPENS...

1. Put frozen food in the oven and close the door.



2. Touch QUICK DEFROST.



The QUICK DEFROST Indicator Light will come on and the Display will show four 0's.



3. Touch Number Pads for the defrosting time you want.



The Display will show the number you touched **in the order you touched them**. This example shows 2 minutes, 30 seconds.



4. Touch START.



The QUICK DEFROST Indicator Light will stay on to show that the oven is in the Quick Defrost Cycle.

The Display counts down the time to show how much defrosting time is left.



**BEEP BEEP BEEP BEEP**

When the defrost time ends, "End" will show on the Display and 4 beeps will sound. (You can stop the beeping by opening the door or by touching CANCEL.) "End" will remain on the Display and a reminder tone will sound every 60 seconds until the door is opened or CANCEL is touched. The Display will then show the time of day.

## Standing Time

For best results, allow the food to stand for a while after defrosting. This helps equalize the temperature of the food to provide more even defrosting.

When COOK follows QUICK DEFROST, the oven automatically provides a standing time equal to the time touched in for QUICK DEFROST. COOK will begin after the automatic standing time.

## About the Quick Defrost Cycle

The microwave oven automatically divides the time set for the Quick Defrost cycle into three equal parts:

First part .....	80% of full Cook Power
Second part .....	50% of full Cook Power
Third part .....	20% of full Cook Power

This automatic step-down in Cook Power helps defrost food quickly and completely.

## Changing or Adding Defrost Time

You can change the defrosting time any time before or after touching START.

- Touch QUICK DEFROST.
- Touch numbers for new time.
- Touch START.

**Any new time setting made while Quick Defrost is operating will continue the defrosting at only 20% of full power.**

The best time to change the setting is near the end of the Quick Defrost cycle.

- Open the door.
- Check the food with long-tined fork; if center area is hard frozen, set additional time.  
**Remember that standing time is necessary to complete defrosting.**
- Close the door and touch START to continue the cycle if no additional time is needed.  
**OR...**
- Touch in new instructions for additional defrosting time.

**NOTE: PAUSE can be set to automatically stop the oven halfway through the Quick Defrost cycle to allow you to turn over or rearrange food for more even defrosting. See page 21 for setting directions.**

## Cooking Automatically After Defrosting

The controls can be set so the microwave oven goes automatically from defrosting to the Cook cycle you have touched in.

### DO THIS...

### THIS HAPPENS...

1. Put food in the oven and close the door.



2. Touch QUICK DEFROST.



The QUICK DEFROST Indicator Light will come on and the Display will show four 0's.



3. Touch Number Pads for the defrosting time you want.



The Display will show the numbers you touched **in the order you touched them**. This example shows 2 minutes, 30 seconds.



4. Touch COOK.



The COOK Indicator Light will come on and the Display will show four 0's.





5. Touch Number Pads for the cooking time you want.



The Display will show the numbers you touched **in the order you touched them**. This example shows 4 minutes, 30 seconds.



6. Touch **COOK POWER**. (Option: Skip to Step 8 if you want to cook at **HIGH** power.)



The **COOK POWER** Indicator Light will come on and the Display will show "P-HI." This shows the oven is preprogrammed to cook at full (HIGH) power.



7. Touch a Number Pad for the Cook Power you want.



The Display will show what you touched. This example shows you touched Number Pad 6 for 60% of full power.



8. Touch **START**.



When you touch **START**, the **QUICK DEFROST** Indicator Light will stay on. All other Indicator Lights will go off. The Display counts down the time to show how much time is left in the Quick Defrost cycle.



When the defrost time ends, the microwave oven automatically lets the food stand for the **same amount of time used for defrosting**. The **QUICK DEFROST** Indicator Light stays on and the Display counts down the standing time. **During the countdown the oven will be dark, and the fan will be off.**

When the standing time is over, you will hear 2 beeps and the Cook cycle will start.

BEEP BEEP



The **COOK** Indicator Light will be on during the Cook cycle. The **COOK POWER** Indicator Light will also be on **if you are using a Cook Power other than HIGH**.

The Display counts down the time to show how much time is left in the second cycle.

continued on next page

End

BEEP BEEP BEEP BEEP

When the Cook cycle ends, "End" will show on the Display and 4 beeps will sound. (You can stop the beeping by opening the door or by touching CANCEL.) "End" will remain on the Display and a reminder tone will sound every 60 seconds until the door is opened or CANCEL is touched. The Display will then show the time of day.

## Cooking with the Temperature Probe

The Temperature Probe helps take guesswork out of cooking roasts and larger casseroles. The probe is designed to turn off the oven when it senses the temperature you choose between 90°F and 200°F. See your MICRO MENUS® Cookbook for helpful information in cooking different types of food.

### DO THIS...

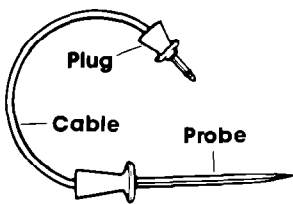

1. Insert at least 1/3 of the Temperature Probe into the food. (See page 20.)

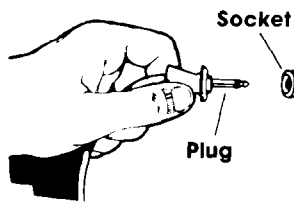

2. Place food in the oven and plug the probe into the socket on the oven wall.

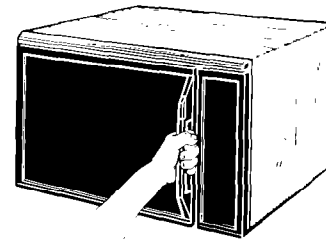

3. Make sure the probe and probe cable do not touch any part of the oven interior. Close the door.

### DO THIS...



4. Touch PROBE TEMP.

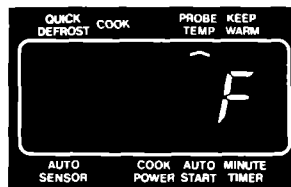

The PROBE TEMP Indicator Light will come on and the Display will show "F."



5. Touch Number Pads for the desired final temperature between 90°F and 200°F.

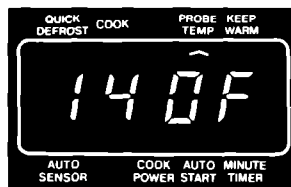

The Display will show the numbers you touched **in the order you touched them**. This example shows a final cooked temperature of about 140°F.



6. Touch COOK POWER. (Option: Skip to Step 8 if you want to use HIGH power.)

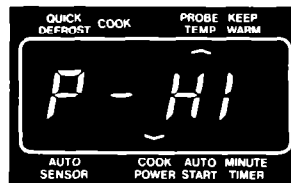

The COOK POWER Indicator Light will come on and the Display will show "P-HI." This shows the oven is pre-programmed to cook at full (HIGH) power.

6

7. Touch the Number Pad for the Cook Power you want.



The Display will show what you touched. This example shows you touched Number Pad 6 for 60% of full power.

START

8. Touch START.



The PROBE TEMP and COOK POWER Indicator Lights will stay on.

The Display will show "COOL" to show the food is less than 90°F. As the food cooks, the Display will show the internal temperature of the food for every 5°F increase.



When the probe senses the temperature you selected, the oven shuts off. "End" will show on the Display and 4 beeps will sound. (You can stop the beeping by opening the door or by touching CANCEL.) "End" will remain on the Display and a reminder tone will sound every 60 seconds until the door is opened or CANCEL is touched. The Display will then show the time of day.

BEEP BEEP BEEP BEEP

**NOTE: ERR will be displayed after START is touched if an incorrect temperature has been set (less than 90°F or more than 200°F).**

**NOTE: Some foods are started using a timed (COOK) cycle and finished by using a temperature (PROBE TEMP) cycle. You can set PROBE TEMP to follow COOK, to avoid the need to reset the oven halfway through cooking. PROBE TEMP can be programmed with the Temperature Probe out. The oven will then pause between COOK and PROBE TEMP. "PROB" will show on the Display to remind you to plug in the probe. Touch START to continue cooking.**

### Changing the Temperature Setting

- When using the Temperature Probe, PROBE TEMP settings can be changed before or during operation:
  - Touch PROBE TEMP.
  - Touch number for new temperature.
  - Touch START. The oven will continue cooking to the new temperature. If the new temperature is lower than the temperature of the food, the oven will shut off.

## Hints for Using the Temperature Probe

### DO...

- stir foods during cooking when recommended.
- stir soups, casseroles and drinks before serving.
- cover roasts with foil after cooking and let stand a few minutes. Remove foil if you decide to cook it longer.
- remove the probe from the oven when not cooking by temperature.

### DON'T...

- let probe or probe cable touch any part of the oven interior.
- let probe touch foil (if used). Foil can be kept away from probe with wooden toothpicks. Remove foil if arcing occurs.
- use paper, plastic wrap or plastic containers. They will be in the oven too long and might distort.
- use probe in regular oven.
- force probe into frozen food.
- use probe for foods that need to simmer.

## Temperature Probe Cooking Tips

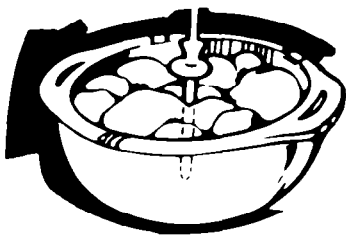

For casseroles, the tip of the probe should be in the center of the food. Stir foods when recommended. Replace the probe.

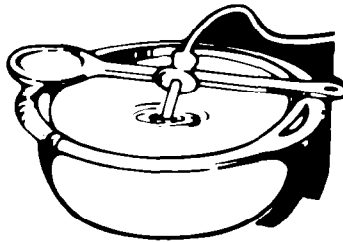

For liquids, balance the probe on a wooden spoon or spatula so the tip of the probe is in the center of the liquid.

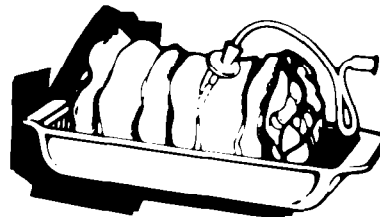

For roasts, the tip of the probe should be in the center of the largest muscle, but not touching fat or bone.

- Casseroles cooked using the Temperature Probe should be made from precooked foods. Do not use raw meats, raw vegetables and cream sauces in casseroles.
- Dry casseroles do not work well.
- Thaw frozen casseroles and meats in the microwave oven before inserting the probe.
- If you are simultaneously cooking individual servings, such as mugs of soup, check the probe setting in several of the items – all the mugs may not heat at the same rate.
- Dry meat loaf mixtures don't work well.
- Remember that roasts may vary in size, shape and composition. Use the Temperature Probe as a guide, as well as the timings for minutes per pound found in the Cooking Guide.

## Removing and Cleaning the Temperature Probe

1. After oven has shut off, unplug the Temperature Probe using hot pads.
2. Wipe probe with a hot sudsy cloth, rinse and dry thoroughly. Use a plastic scouring pad to remove cooked-on foods.
3. Probe may be placed in the silverware basket of the dishwasher.

## Using PAUSE

Your microwave oven can be set to pause halfway through QUICK DEFROST and after the automatic part of AUTO SENSOR to allow you to stir or turn the food or to add ingredients. PAUSE will automatically occur between COOK and PROBE TEMP to allow you to plug in the probe.

### Using PAUSE with QUICK DEFROST

#### DO THIS...

1. Put frozen food in the oven and close the door.



2. Touch QUICK DEFROST.



3. Touch Number Pads for the defrosting time you want.



4. Touch PAUSE.



5. Touch START.

#### THIS HAPPENS...



The QUICK DEFROST Indicator Light will come on and the Display will show four 0's.



The Display will show the number you touched in **the order you touched them**. This example shows 2 minutes, 30 seconds.



The Display will show "PAUS:"



The QUICK DEFROST Indicator Light will stay on to show that the oven is in the Quick Defrost Cycle.

The Display counts down the time to show how much defrosting time is left.

*BEEP BEEP*



Halfway through QUICK DEFROST, two beeps will sound and the oven will shut off.

"PAUS" will show on the Display and the QUICK DEFROST Indicator Light will stay on.

continued on next page.

6. Turn over or rearrange food being defrosted. Close door.

**NOTE:** Oven will remain off until you touch **START**.



7. Touch **START**.

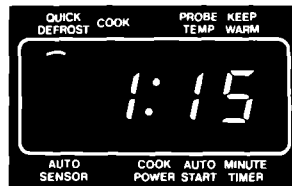

The **QUICK DEFROST** indicator stays on and the Display counts down the remaining time.



BEEP BEEP BEEP BEEP

When the defrost time ends, "End" will show on the Display and 4 beeps will sound. (You can stop the beeping by opening the door or by touching **CANCEL**.) "End" will remain on the Display and a reminder tone will sound every 60 seconds until the door is opened or **CANCEL** is touched. The Display will then show the time of day.

## Using **PAUSE** with **AUTO SENSOR**

Pause may be used in **AUTO SENSOR** with the Cook/Reheat or Cook Frozen cycles **only**.

1. Put food in the oven and close the door.
2. Touch **COOK/REHEAT** or **COOK FROZEN**.
3. Touch a Number Pad for the cooking category you want.
4. Touch **PAUSE**.
5. Touch **START**.

When the first part of the **AUTO SENSOR** cycle is done, you will hear 2 beeps and the oven will shut off.

6. Open the door. Stir or turn the food or add ingredients. Close the door.
7. Touch **START** to continue.

**NOTE:** The oven will remain off until you touch **START**.

## Adding **PAUSE** to Cycle in Operation

Pause can be added to **QUICK DEFROST** or **AUTO SENSOR** after **START** has been touched.

1. Touch **PAUSE**.
2. Touch **START**.

The oven will automatically stop halfway through **QUICK DEFROST** to allow you to turn over or rearrange the food being defrosted. It will stop after the first (AS) part of the **AUTO SENSOR** cycle to allow you to stir, rotate or rearrange food or to add ingredients. **NOTE:** The oven will remain off until you touch **START**.

## Pause is Automatic between **COOK** and **PROBE TEMP**

Your microwave oven will automatically pause between **COOK** and **PROBE TEMP**. "PROB" will show on the Display to remind you to plug in the probe. Touch **START** to continue cooking.

## Using KEEP WARM

Hot, cooked foods can be safely kept warm in your microwave oven for up to 99 minutes, 99 seconds (about 1 hour, 40 minutes). KEEP WARM can be used by itself, or it can automatically follow a cooking cycle or PROBE TEMP cycle.

### DO THIS...

### THIS HAPPENS...

1. Put cooked, hot food in oven and close door.



2. Touch KEEP WARM.



The KEEP WARM Indicator Light will come on. The Display will show the time of day.



3. Touch START.



The KEEP WARM Indicator Light will stay on. The oven light and the fan will come on. The Display will continue to show the time of day.

- KEEP WARM operates for up to 99 minutes, 99 seconds.
- Opening the oven door cancels KEEP WARM. Close the door and touch KEEP WARM, then START if additional KEEP WARM time is desired.
- Foods cooked covered should be covered during KEEP WARM.
- Pastry items (pies, turnovers, etc.) should be uncovered during KEEP WARM.
- Complete meals kept warm on a dinner plate should be covered during KEEP WARM.
- The use of more than one complete KEEP WARM (about 1 hour, 40 minutes) is not recommended. The quality of some foods will suffer with extended time.

## To Automatically Follow Another Cycle

- **While you are touching in cooking instructions**, touch KEEP WARM before touching START.
- **OR...**
- **After the oven starts operating**, touch KEEP WARM and then START.
- When the last cooking cycle is over you will hear 4 beeps. The KEEP WARM Indicator Light will come on and the time of day will be displayed while the oven continues to run.
- KEEP WARM can be programmed to follow AUTO SENSOR, QUICK DEFROST, COOK or PROBE TEMP.

## Using AUTO START

The microwave oven can be set to start automatically at a later time. Use AUTO START to delay the start of cooking for up to 11 hours, 59 minutes.

### DO THIS...

### THIS HAPPENS...

**1. Make sure the Clock is set to correct time of day. See page 6 if any change is needed.**

**2. Put food in oven and close the door. (See WARNING on page 26.)**



**3. Touch AUTO START.**

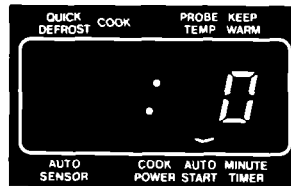

The AUTO START Indicator Light will come on and the Display will show a "0."



**4. Touch Number Pads for the time of day you want cooking to start.**



The Display will show the numbers you touched **in the order you touched them**. This example shows 5 o'clock.



**5. Touch COOK.**

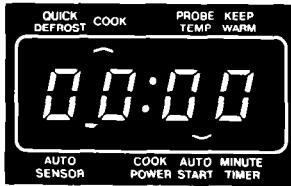

The COOK Indicator Light will come on and the Display will show four 0's.



**6. Touch Number Pads for the cooking time you want.**



The Display will show the numbers you touched **in the order you touched them**. This example shows 8 minutes, 30 seconds.



**COOK  
POWER**

**7. Touch COOK POWER. (Option:  
Skip to Step 9 if you want to  
use HIGH power.)**

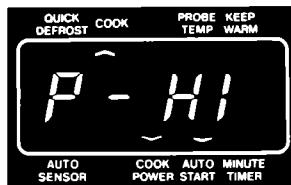

The COOK POWER Indicator Light will come on and the Display will show "P-HI!" This shows the oven is pre-programmed to cook at full (HIGH) power.

**7**

**8. Touch a Number Pad for  
the Cook Power you want.**



The Display will show what you touched. This example shows you touched Number Pad 7 for 70% of full power.

**START**

**9. Touch START.**



The AUTO START Indicator Light will stay on. All other Indicator Lights will go off. The Display will go back to showing the time of day.



When the time of day reaches the time you have set in AUTO START, the AUTO START Indicator Light will go off, the COOK and Cook Power Indicator Lights will come on, the cooking time will show on the Display, and the oven will start cooking.

count  
down

The Display counts down the time to show how much time is left in COOK

**End**

**BEEP BEEP BEEP BEEP**

When the cooking time ends, "End" will show on the Display and 4 beeps will sound. (You can stop the beeping by opening the door or by touching CANCEL.) "End" will remain on the Display and a reminder tone will sound every 60 seconds until the door is opened or CANCEL is touched. The Display will then show the time of day.

**Note: If the oven light and fan come on when you touch START, the Start Time has not been set correctly. Open and close door, reprogram AUTO START time, then touch START.**

## Additional Information

- Additional cycles can be set when using AUTO START. Follow instructions under the proper heading (Using AUTO SENSOR, Defrosting, Using KEEP WARM) either before or after you touch START.
- You can change times, or add cycles at any time during the AUTO START cycle.
  1. Touch COOK.
  2. Touch numbers for new cooking time, if desired.
  3. Touch COOK POWER for new Cook Power, if desired.
  4. Touch number for new Cook Power, if desired. Or touch COOK POWER again if HIGH is desired.
  5. Touch START.
- Opening the door does not stop Auto Start operation.

## **⚠ WARNING**

### **To avoid sickness and food waste when using AUTO START:**

- **Do not use foods that will spoil while waiting for cooking to start, such as dishes with milk or eggs, cream soups, and cooked meats or fish. Any food that has to wait for cooking to start should be very cold or frozen before it is put in the oven. MOST UNFROZEN FOODS SHOULD NEVER STAND MORE THAN TWO HOURS BEFORE COOKING STARTS.**
- **Do not use foods containing baking powder or yeast when using AUTO START. They will not rise properly.**
- **Do not allow food to remain in oven for more than two hours after end of cooking cycle.**

## Other Operating Hints

There are a number of things you can do with your microwave oven. Some will be reminders. Others will be mentioned for the first time.

### **1. To double check settings while the oven is running:**

- Touch the Command Pad for the setting you want to check. The instruction programmed for that pad will show on the Display for 5 seconds. Then the Display returns to showing what the oven is doing.

### **2. To stop the oven while it is running:**

- Open the door. The oven will stop. To restart the oven, close the door and touch START.
- Touch CANCEL. All instructions will be erased. You must touch in new instructions.

### **3. If you touch two instructions into the same cycle, the second set of instructions will cancel the first.**

## Bi-Level Cooking Rack

Use the metal Bi-Level Cooking Rack when cooking in more than one container. The metal rack can be turned upside-down to help fit taller containers on the bottom of the oven. See the MICRO MENUS® Cookbook provided with your oven for examples of menus that can be cooked using the Bi-Level Cooking Rack.

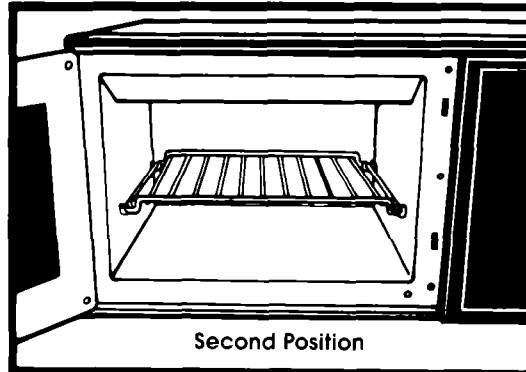
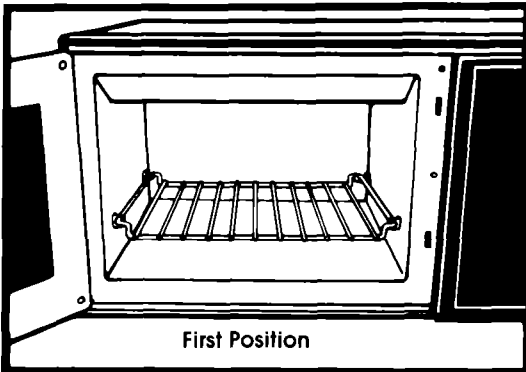

**Note:** Do not store the metal rack in the oven. Arcing and damage to the oven can result if someone accidentally starts the oven.

### Inserting the Rack

- Insert the rack securely into the rack supports on the side walls of the oven (first position).
- Turn rack upside-down when using a taller container on the bottom of the oven (second position).

### Cleaning the Rack

- Wash by hand with a mild detergent and a soft or nylon scrub brush. Dry completely.
- Do not use abrasive scrubbers or cleansers.

### ⚠ WARNING

#### Personal Injury and Product Damage Hazard

- Use hot pads when removing rack from oven after cooking to prevent burns. Rack may be hot.
- Do not store the metal rack in the oven. Arcing and damage to the oven can result if someone accidentally starts the oven.
- Do not operate the oven with the metal rack stored on the floor of the oven. Damage to the interior finish will result.
- Use rack only in the microwave oven.
- Do not use rack with browning dish.
- Do not let food container on rack touch the top or sides of the oven.
- Do not cook foods directly on rack without putting them in containers first.
- Do not place a metal cooking container on rack.

# Installation instructions

BEFORE YOU BEGIN, READ THE FOLLOWING INSTRUCTIONS COMPLETELY AND CAREFULLY.

## Installing Your Microwave Oven

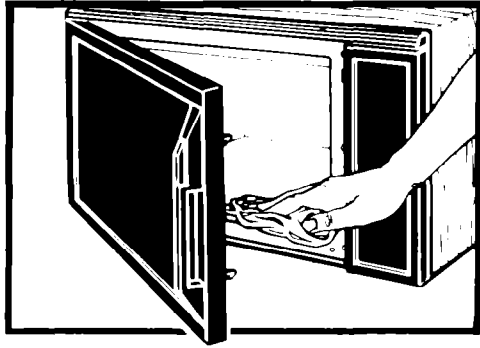

**1.** Empty the microwave oven and clean inside it with a soft, damp cloth. Check for damage such as misaligned door, damage around the door or dents inside the oven or on the exterior. If there is any damage, please do not operate the unit until it has been checked by an authorized Whirlpool service technician and any repairs made.

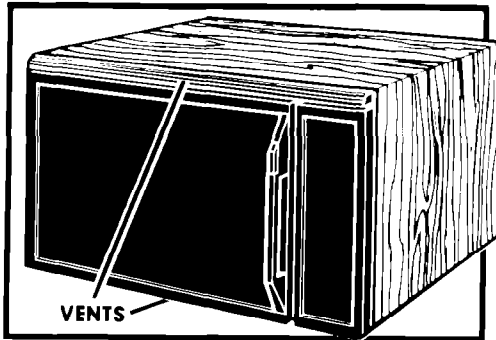

**3.** Do not block the vent opening at the front of the oven or the air intake opening on the bottom of the oven. Blocking vent or air intake openings can cause poor cooking results.

Make sure the microwave oven legs are in place. Do not set the oven on anything that will block the air intake openings.

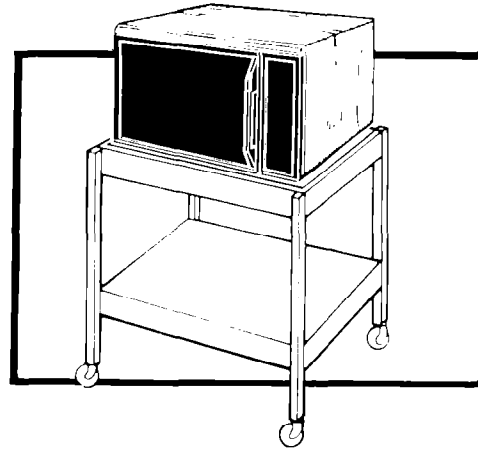

**2.** Put the oven on a cart, counter, table or shelf that is strong enough to hold the oven, the food and the utensils you put in it. **(The control side of the unit is the heavy side. Use care when handling.)** The weight of the oven is approximately 60 lbs. (27 kg).

### **CAUTION**

Do not install the oven next to a conventional surface unit or in any area where excessive heat and steam are generated. This could damage the outside of the cabinet.

## 5. Electrical requirements

**Observe all governing codes and ordinances.**

A 120 Volt, 60 Hz., AC only, 15 or 20 amp fused electrical supply is required. (Time-delay fuse is recommended.) It is recommended that a separate circuit serving only this appliance be provided.

## 6. GROUNDING INSTRUCTIONS

### **⚠ WARNING**

#### **Electrical Shock Hazard**

**Improper use of the grounding plug can result in a risk of electrical shock. DO NOT UNDER ANY CIRCUMSTANCES, REMOVE THE POWER SUPPLY CORD GROUNDING PRONG.**

**7.** For your personal safety, this appliance must be grounded. In the event of an electrical short circuit, grounding reduces the risk of electric shock by providing an escape wire for the electric current. This appliance is equipped with a

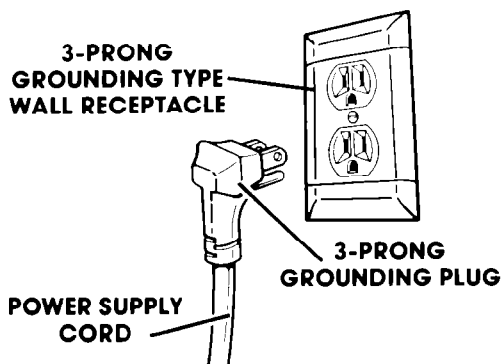

polarized 3-prong grounding plug. It must be plugged into a correct polarized mating 3-prong grounding type wall receptacle, properly installed and grounded in accordance with the National Electrical Code and local codes and ordinances. If a mating wall receptacle is not available or if you are not sure if the

wall receptacle is properly grounded and polarized, have it checked by a qualified electrician.

It is the personal responsibility and obligation of the customer to have a properly grounded and correctly polarized 3-prong wall receptacle installed by a qualified electrician.

Consult a qualified electrician if the grounding instructions are not completely understood, or if doubt exists as to whether the appliance is properly grounded.

**It is NOT recommended to use an extension cord with your microwave oven, but if you find it necessary to do so temporarily (until a properly grounded and polarized 3-prong receptacle is installed), use only a heavy duty UL listed 3-wire grounding type extension cord containing three 16-gauge (minimum) copper wires.** It must not be longer than 10 feet (cords longer than 10 feet may affect the cooking performance of your microwave oven). The plug on the extension cord must fit into a 3-prong grounding type wall receptacle (as shown on this page) and the receptacle end of the extension cord must accept the 3-prong grounding plug of the microwave oven.



**8.** To test the oven, plug it into the proper electrical outlet and put about one cup (250 mL) of cold water in a glass container in the oven. Close the door. Make sure it latches. Follow the directions on page 12 to set the oven to COOK for 1½ minutes. When the time is up, the water should be heated.

**9. This microwave oven is designed for use in the household only and must not be used for commercial purposes.**

**DO NOT** remove the outer case, door, or control panel at any time. The unit is equipped with high voltage and should not be serviced unless by an authorized Whirlpool trained service technician.

## SAVE THESE INSTRUCTIONS

## Building in Your Microwave Oven

Your microwave oven is not limited to carts, counters or tables. Custom installations are made easy with kits available from your dealer.

- 1.** Build the microwave oven into a cabinet or wall by itself or over built-in single ovens in the Whirlpool RDE, REE, RGE, RB and SB model series.
- 2.** Attach the microwave oven to a wall by itself or with cabinets over it.
- 3.** Put the microwave oven on the MICRO SHELF® Hood over a cooktop. The hood is available ducted or as a recirculating hood, and includes cooktop lights.

Ask your dealer for details on...

- 832987 – 30-inch Built-in Kit (Black)
- 815033 – 30-inch Built-in Kit (White)
- 832991 – 27-inch Built-in Kit (Black)
- 832989 – 24-inch Built-in Kit
- 832993 – Wall Mounting Kit
- RH3330XR – MICRO SHELF® Hood

**Use only approved installation kits.  
Obtain these kits from your authorized  
Whirlpool dealer.**

# Caring for your microwave oven

## Cleaning the Microwave Oven

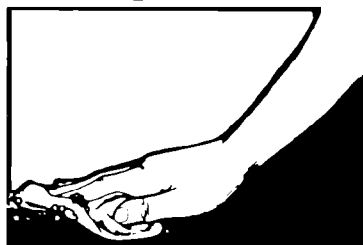

Wipe often with warm sudsy water and a soft cloth or sponge.

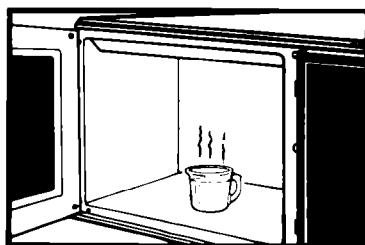

For stubborn soil, boil a cup of water in the oven for 2 or 3 minutes. Steam will soften the soil.

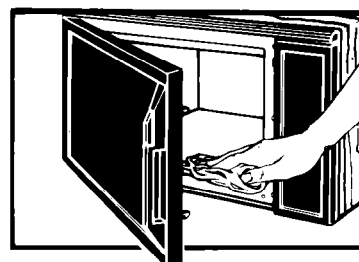

**Be sure to keep the areas clean where the door and oven frame touch when closed.** Use only mild, non-abrasive soaps or detergents applied with a sponge or soft cloth when cleaning surfaces of door and oven that come together. Rinse well.

### CAUTION

**Abrasive cleansers, steel wool pads, gritty wash cloths, etc., can damage the control panel, and the interior and exterior oven surfaces. Use a soft cloth or a sponge with a mild detergent or spray glass cleaner.**

## Replacing the Light Bulb

The microwave oven light should come on whenever the door is opened or the oven is operating.

### WARNING

#### Electrical Shock Hazard

**Disconnect power supply before replacing the light bulb. Failure to do so could result in electrical shock.**

#### To replace:

1. Unplug appliance or disconnect at the main power supply.
2. Open the oven door.
3. Remove the 3 screws from the front of the cover.
4. Pull down the front portion of the cover. (It is creased across its width to form a hinge.)
5. Remove and replace the 25-watt candle-base bulb (Part No. 313969). Obtain bulb from your authorized Whirlpool dealer.
6. Close the cover and replace the screws.
7. Plug in appliance or reconnect at the main power supply.

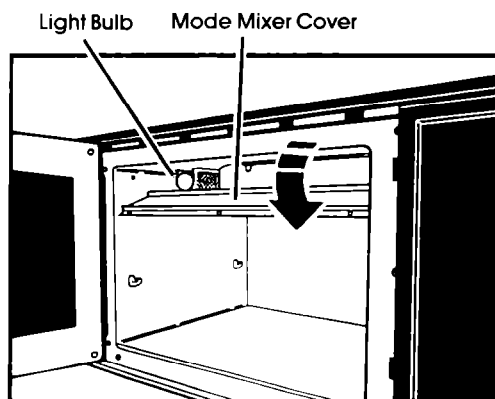

# How your microwave oven works

Microwave ovens are safe. Microwave energy is not hot. It causes food to make its own heat, and it's this heat that cooks the food.

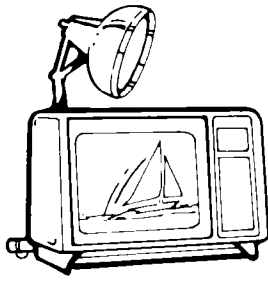

Microwaves are like TV waves or light waves. You can't see them, but you can see what they do.

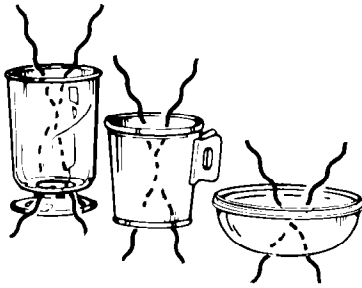

Microwaves pass through glass, paper and most plastics without heating them so food absorbs the energy. Microwaves bounce off metal pans so food does not absorb the energy.

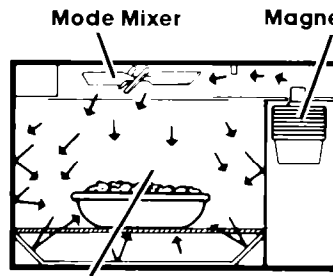

Oven Cavity

A magnetron in the microwave oven produces microwaves. The microwaves move into the oven where they are scattered or stirred by a mode mixer (like a fan). Microwaves bounce off metal oven walls and are absorbed by food.

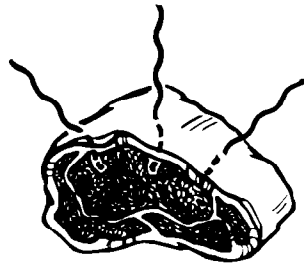

Microwaves may not reach the center of a roast. The heat around the outside is what cooks the roast all the way through. This is one of the reasons for letting some foods (roasts, baked potatoes) stand for a while after cooking, or for stirring some foods during the cooking time.

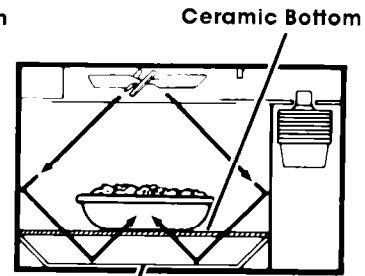

Metal Floor

The ceramic bottom of your microwave oven lets microwaves through. Then they bounce off a metal floor, back through the ceramic bottom and are absorbed by the food.



The microwaves disturb water molecules in the food. As the molecules bounce around bumping into each other, heat is made, like rubbing your hands together. This is the heat that cooks.



# Operating safety precautions

## **⚠ WARNING**

To reduce the risk of fire, electrical shock, injury to persons, or damage when using the microwave oven, follow the precautions on pages 33 and 34.

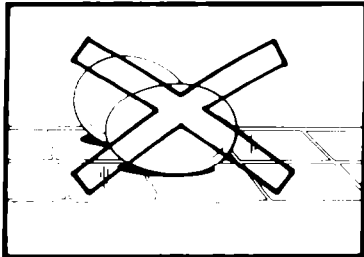

### **NEVER COOK OR REHEAT A WHOLE EGG.**

Steam build-up in whole eggs may cause them to burst and burn you, and possibly damage the oven. Slice hard boiled eggs before heating. In rare instances, poached eggs have been known to explode. Cover poached eggs and allow a standing time of one minute before cutting into them.

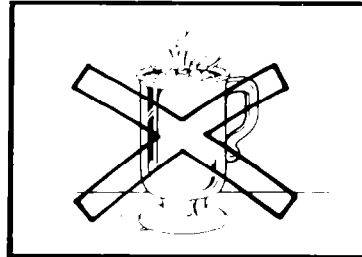

Liquids heated in certain containers (especially cylindrical-shaped containers) may become overheated. The liquid may splash out with a loud noise during or after heating or when adding ingredients (coffee, etc.) resulting in harm to the oven and possible personal injury. For best results stir any liquid several times before heating or reheating.

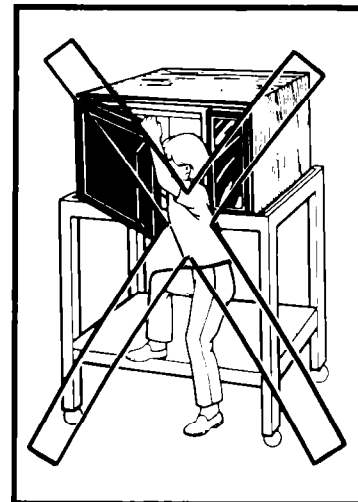

**NEVER** lean on the door or allow a child to swing on it when the door is open. Injury could result.

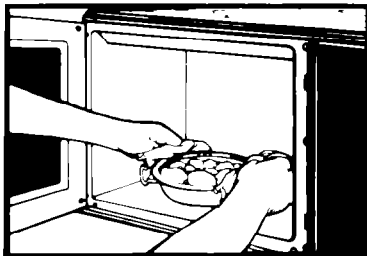

**USE HOT PADS.** Microwave energy does not heat containers, but the hot food does.

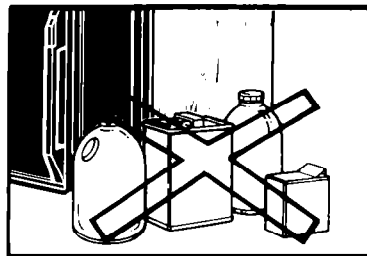

**DO NOT** heat, store or use flammable, inflammable or corrosive materials in or near the oven. Fumes can create a fire hazard or explosion.

**DO NOT** can foods in the oven. Closed glass jars may explode resulting in damage to the oven or possible personal injury.

**DO NOT** use the oven to sterilize objects (baby bottles, etc.). It is difficult to maintain the high temperature required for safe sterilization.

**DO NOT** deep fry in the oven. Microwavable utensils are not suitable and it is difficult to maintain appropriate deep frying temperatures.

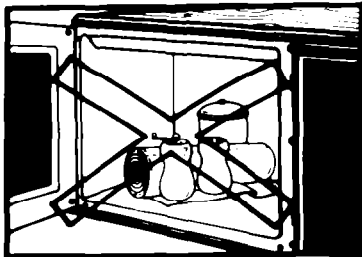

**DO NOT** use the oven for storage. Do not leave paper products, books or cooking utensils in the oven when not in use. Fire may result if someone accidentally starts the oven. Don't let anything touch the top of the oven.

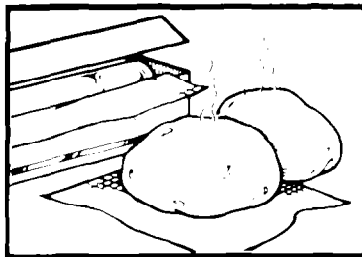

**DO NOT OVERCOOK POTATOES.** Fire could result. At the end of the recommended cooking time they should be slightly firm. Wrap in foil and set aside for 5 minutes. They will finish cooking while standing.

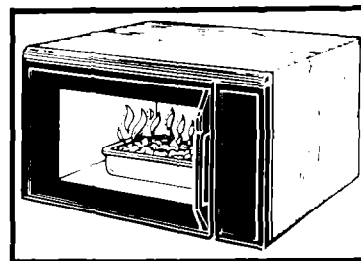

If a fire should start in the oven cavity:

- **keep door closed**
- **turn oven off**
- **disconnect the power supply** at the cord, fuse box or circuit breaker.

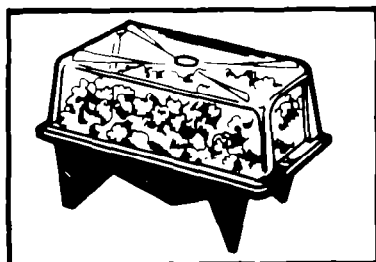

**DO NOT** pop popcorn, except in a microwave approved popcorn popper or commercial package designed especially for microwave ovens.

**NEVER** try to pop popcorn in a paper bag. Overcooking may result in smoke and fire.

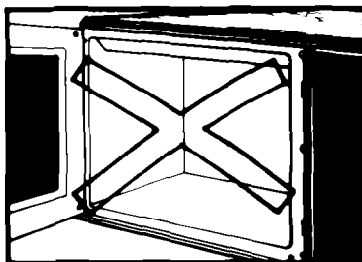

Starting a microwave oven when it's empty is not recommended. If you experiment, put a container of water in the oven.

It is normal for the inside of the oven door to look wavy after the oven has been running for a while.

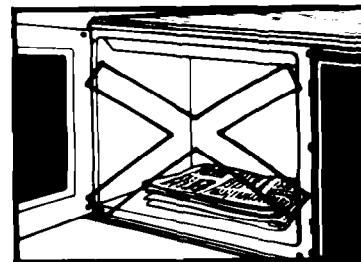

**DO NOT** use newspaper or other printed paper in the oven. Fire could result.

**DO NOT** dry flowers, fruit, herbs, wood, paper, gourds or clothes in the oven. Fire could result.

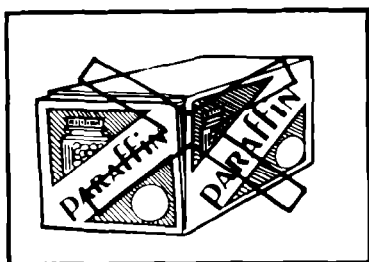

**DO NOT** try to melt paraffin wax in the oven. You may be burned.

### General information

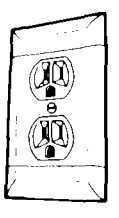

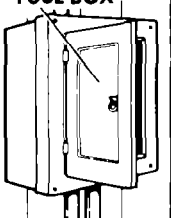

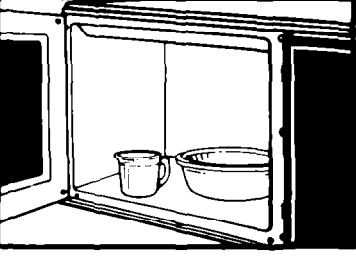

If your electric power line or outlet voltage is less than the normal 120 volts, cooking times may be longer.

To test a dish for safe use, put it into the oven with a cup of water beside it. Cook on HIGH Cook Power for one minute. **If the dish gets hot and water stays cool, do not use it.**

# If you need service or assistance, we suggest you follow these five steps:

## 1. Before calling for assistance...

Performance problems often result from little things you can find and fix yourself without tools of any kind.

### If nothing operates:

- Is the power supply cord plugged into a live circuit with the proper voltage? (See page 29.)
- Have you checked your home's main fuses or circuit breaker box?
- Have you checked the electric company for a power failure?

### If the microwave oven will not run:

- Is the timer set?
- If the Temperature Probe is being used, is it plugged tightly into its socket?
- Is the door firmly closed and latched?
- Did you touch START?
- Did you follow the directions exactly?

### If the microwave cooking times seem too long:

- Is the electric supply to your home low or lower than normal? Your electric company can tell you if the line voltage is low.
- Is the Cook Power at the recommended setting?
- Are you allowing for more time when cooking more food at one time?

### If the Display shows a time counting down but the oven is not cooking:

- Is the Minute Timer in use?
- Is the oven door closed completely?
- Is the oven in standing time between QUICK DEFROST and COOK? (See page 15.)

### If you do not hear a Programming Tone (page 6):

- Is the command correct?
- Has the tone been cancelled?

### If the fan seems to be running slower than usual:

- Has the oven been stored in a cold area? The fan will run slower until the oven warms up to normal room temperature.

### If there has been a power interruption, the Display will show 88:88. Reset the Clock (page 6).

### If the microwave oven turns off too soon or not soon enough when using the probe:

- Is at least  $\frac{1}{3}$  of the probe in the food?
- Is the probe tip in the center of the food?
- Is the probe touching bone or fat?
- Have you allowed roasts to stand for a few minutes after cooking?
- Is the probe plugged tightly into its socket?
- Is the Cook Power set correctly?
- Is the Probe Temperature set correctly?

## 2. If you need assistance\*...

Call Whirlpool COOL-LINE® service assistance telephone number. Dial free from anywhere in the U.S.:  
**1-800-253-1301**

and talk with one of our trained Consultants. The Consultants can instruct you in how to obtain satisfactory operation from your appliance or, if service is necessary, recommend a qualified service company in your area.

## 3. If you need service\*...



Whirlpool has a nationwide network of franchised TECH-CARE® service companies. TECH-CARE service technicians are trained to fulfill the product warranty and provide after-warranty service, anywhere in the United States. To locate TECH-CARE service in your area, call our COOL-LINE service assistance telephone number (see Step 2) or look in your telephone directory Yellow Pages under:

APPLIANCES - HOUSEHOLD -  
MAJOR - SERVICE & REPAIR

ELECTRICAL APPLIANCES -  
MAJOR - REPAIRING & PARTS

OR

WHIRLPOOL APPLIANCES  
FRANCHISED TECH-CARE SERVICE

WHIRLPOOL APPLIANCES  
FRANCHISED TECH-CARE SERVICE

SERVICE COMPANIES

SERVICE COMPANIES

XYZ SERVICE CO  
123 MAPLE

999-9999

XYZ SERVICE CO  
123 MAPLE

999-9999

OR

WASHING MACHINES, DRYERS  
& IRONERS - SERVICING

WHIRLPOOL APPLIANCES  
FRANCHISED TECH-CARE SERVICE

SERVICE COMPANIES

XYZ SERVICE CO  
123 MAPLE

999-9999

## 4. If you have a problem\*...

Call our COOL-LINE service assistance telephone number (see Step 2) and talk with one of our Consultants, or if you prefer, write to:

Mr. Donald Skinner  
Director of Customer Relations  
Whirlpool Corporation  
2000 M-63  
Benton Harbor, MI 49022

Please include a daytime phone number in your correspondence.

## 5. If you need FSP® replacement parts\*...

FSP® is a registered trademark of Whirlpool Corporation for quality parts. Look for this symbol of quality whenever you need a replacement part for your Whirlpool appliance. FSP replacement parts will fit right and work right, because they are made to the same exacting specifications used to build every new Whirlpool appliance.

To locate FSP replacement parts in your area, refer to Step 3 above or call the Whirlpool COOL-LINE service assistance number in Step 2.

\*If you must call or write, please provide: model number, serial number, date of purchase, and a complete description of the problem. This information is needed in order to better respond to your request for assistance.

# WHIRLPOOL® MICROWAVE OVEN WARRANTY

M W001

LENGTH OF WARRANTY	WHIRLPOOL WILL PAY FOR
<b>FULL ONE-YEAR WARRANTY</b> From Date of Purchase	FSP® replacement parts and repair labor to correct defects in materials or workmanship. Service must be provided by a franchised TECH-CARE® service company.
<b>LIMITED FOUR-YEAR WARRANTY</b> Second Through Fifth Year From Date of Purchase	FSP replacement parts for solid-state touch control system if defective in materials or workmanship. (Touch Control models only.) The solid-state touch control parts are shown below.
<b>LIMITED NINE-YEAR WARRANTY</b> Second Through Tenth Year From Date of Purchase	FSP replacement magnetron tube if defective in materials or workmanship. The magnetron is shown below.
<b>WHIRLPOOL WILL NOT PAY FOR</b>	
<p><b>A.</b> Service calls to:</p> <ol style="list-style-type: none"> <li>1. Correct the installation of the microwave product.</li> <li>2. Instruct you how to use the microwave product.</li> <li>3. Replace house fuses or correct house wiring.</li> <li>4. Replace owner accessible light bulbs.</li> </ol> <p><b>B.</b> Repairs when microwave product is used in other than normal, single-family household use.</p> <p><b>C.</b> Pick up and delivery. This product is designed to be repaired in the home.</p> <p><b>D.</b> Damage to microwave product caused by accident, misuse, fire, flood, acts of God or use of products not approved by Whirlpool.</p> <p><b>E.</b> Any labor costs during the limited warranties.</p>	

WHIRLPOOL CORPORATION SHALL NOT BE LIABLE FOR INCIDENTAL OR CONSEQUENTIAL DAMAGES. Some states do not allow the exclusion or limitation of incidental or consequential damages so this limitation or exclusion may not apply to you. This warranty gives you specific legal rights, and you may also have other rights which vary from state to state.

Outside the United States, a different warranty may apply. For details, please contact your franchised Whirlpool distributor or military exchange.

## SOLID-STATE TOUCH CONTROL AND MAGNETRON COVERED BY YOUR WARRANTY

