



# TOP-MOUNT REFRIGERATOR

Use & Care Guide

---

# TABLE OF CONTENTS

<b>REFRIGERATOR SAFETY .....</b>	<b>3</b>
Proper Disposal of Your Old Refrigerator .....	3
<b>INSTALLATION INSTRUCTIONS .....</b>	<b>4</b>
Unpack the Refrigerator .....	4
Location Requirements .....	4
Electrical Requirements .....	5
Water Supply Requirements .....	5
Connect the Water Supply .....	5
Refrigerator Doors .....	6
Adjust the Doors .....	10
Normal Sounds .....	10
<b>REFRIGERATOR USE .....</b>	<b>10</b>
Ensuring Proper Air Circulation .....	10
Using the Controls .....	11
Adjusting Control Settings .....	11
Ice Maker .....	11
<b>REFRIGERATOR FEATURES .....</b>	<b>12</b>
Refrigerator Shelves .....	12
Crispers and Meat Drawers .....	12
Crisper Humidity Control .....	13
Chilled Meat Drawer .....	13
Wine or Can/Bottle Rack .....	13
Utility or Egg Bin .....	13
<b>FREEZER FEATURES .....</b>	<b>14</b>
Freezer Shelf .....	14
Pull-out Freezer Floor .....	14
<b>DOOR FEATURES .....</b>	<b>14</b>
Door Rails .....	14
Can Racks and Door Bins .....	15
Adjustable Utility Compartment & Tray .....	15
Flip-up Door Shelf .....	15
<b>REFRIGERATOR CARE .....</b>	<b>15</b>
Cleaning .....	15
Changing the Light Bulbs .....	16
Power Interruptions .....	16
Holiday and Moving Care .....	16
<b>TROUBLESHOOTING .....</b>	<b>17</b>
<b>ASSISTANCE OR SERVICE .....</b>	<b>18</b>
<b>WARRANTY .....</b>	<b>20</b>

# REFRIGERATOR SAFETY

## Your safety and the safety of others are very important.

We have provided many important safety messages in this manual and on your appliance. Always read and obey all safety messages.



This is the safety alert symbol.

This symbol alerts you to potential hazards that can kill or hurt you and others.

All safety messages will follow the safety alert symbol and either the word "DANGER" or "WARNING."

These words mean:

**⚠ DANGER**

You can be killed or seriously injured if you don't immediately follow instructions.

**⚠ WARNING**

You can be killed or seriously injured if you don't follow instructions.

All safety messages will tell you what the potential hazard is, tell you how to reduce the chance of injury, and tell you what can happen if the instructions are not followed.

## IMPORTANT SAFETY INSTRUCTIONS

**WARNING:** To reduce the risk of fire, electric shock, or injury to persons when using your refrigerator, follow these basic precautions:

- Plug into a grounded (earthed) outlet.
- Do not remove ground prong.
- Do not use an adapter.
- Do not use an extension cord.
- Disconnect power before servicing.
- Replace all panels before operating.
- Remove doors from your old refrigerator.
- Use nonflammable cleaner.
- Keep flammable materials and vapors, such as gasoline, away from refrigerator.
- Use two or more people to move and install refrigerator.
- Disconnect power before installing ice maker (on ice maker kit ready models only).
- Use a sturdy glass when dispensing ice or water (on some models).
- The appliance is not intended for use by young children or infirm persons without supervision.
- Young children should be supervised to ensure that they do not play with the appliance.
- If the supply cord is damaged, it must be replaced by the manufacturer, its service agent or similar qualified persons in order to avoid a hazard.

**SAVE THESE INSTRUCTIONS**

## Proper Disposal of Your Old Refrigerator

**⚠ WARNING**

**Suffocation Hazard**

**Remove doors from your old refrigerator.**

**Failure to do so can result in death or brain damage.**

**IMPORTANT:** Child entrapment and suffocation are not problems of the past. Junked or abandoned refrigerators are still dangerous – even if they will sit for “just a few days.” If you are getting rid of your old refrigerator, please follow these instructions to help prevent accidents.

## Before you throw away your old refrigerator or freezer

- Take off the doors.
- Leave the shelves in place so that children may not easily climb inside.

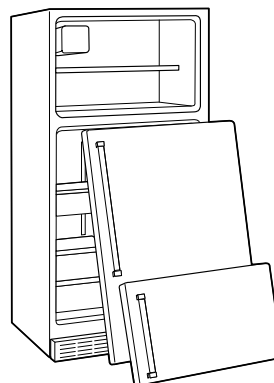

# INSTALLATION INSTRUCTIONS

## Unpack the Refrigerator

### **⚠ WARNING**

#### **Excessive Weight Hazard**

Use two or more people to move and install refrigerator.

Failure to do so can result in back or other injury.

## Removing the Packaging

- Remove tape and glue from your refrigerator before using. To remove any remaining tape or glue, rub the area briskly with your thumb. Tape or glue residue can also be easily removed by rubbing a small amount of liquid dish soap over the adhesive with your fingers. Wipe with warm water and dry.
- Do not use sharp instruments, rubbing alcohol, flammable fluids, or abrasive cleaners to remove tape or glue. These products can damage the surface of your refrigerator. For more information, see “Refrigerator Safety” section.
- On some models, shelves, bins, door shelf rails, and other feature parts may be packaged in the Interior FeaturePak. Follow the instructions contained in the package for proper assembly.

**IMPORTANT:** Do not remove the white foam air return insert that is located behind the control panel on the ceiling of the refrigerator (on some models). The insert is part of the refrigerator and not part of the packing material. If the insert is removed, ice may migrate down from the freezer and cause icicles to form.

### **When Moving Your Refrigerator:**

Your refrigerator is heavy. When moving the refrigerator for cleaning or service, be sure to protect the floor. Always pull the refrigerator straight out when moving it. Do not wiggle or “walk” the refrigerator when trying to move it, as floor damage could occur.

## Clean Before Using

After you remove all of the package materials, clean the inside of your refrigerator before using it. See the cleaning instructions in “Refrigerator Care.”

### **Important information to know about glass shelves and covers:**

Do not clean glass shelves or covers with warm water when they are cold. Shelves and covers may break if exposed to sudden temperature changes or impact, such as bumping. For your protection, tempered glass is designed to shatter into many small, pebble-size pieces. This is normal. Glass shelves and covers are heavy. Use special care when removing them to avoid impact from dropping.

## Location Requirements

### **⚠ WARNING**



#### **Explosion Hazard**

Keep flammable materials and vapors, such as gasoline, away from refrigerator.

Failure to do so can result in death, explosion, or fire.

To ensure proper ventilation for your refrigerator, allow for a 1/2" (1.25 cm) space on each side and at the top. When installing your refrigerator next to a fixed wall, leave 2" (5.08 cm) minimum on each side (depending on your model) to allow for the door to swing open. If your refrigerator has an ice maker, allow extra space at the back for the water line connections.

**NOTE:** Do not install the refrigerator near an oven, radiator, or other heat source, nor in a location where the temperature will fall below 55°F (13°C).

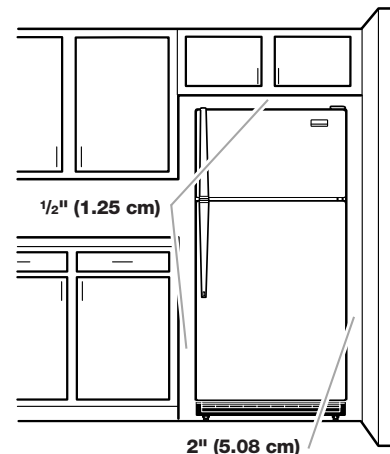

## Electrical Requirements

### **⚠ WARNING**



#### Electrical Shock Hazard

**Plug into a grounded (earthed) outlet.**

**Do not remove ground prong.**

**Do not use an adapter.**

**Do not use an extension cord.**

**Failure to follow these instructions can result in death, fire, or electrical shock.**

Before you move your refrigerator into its final location, it is important to make sure you have the proper electrical connection:

#### Recommended Grounding Method

Plug 1: A 115 Volt, 60 Hz., AC only 15 or 20 ampere fused, grounded (earthed) electrical supply is required.

Plugs 2 and 3: A 220/240 Volt/50 Hz or 220 Volt/60Hz AC only 10 ampere fused and grounded (earthed) electrical supply is required.

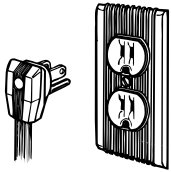

Plug 1

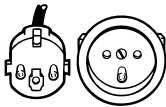

Plug 2

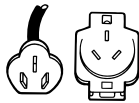

Plug 3

It is recommended that a separate circuit serving only your refrigerator be provided. Use an outlet that cannot be turned off by a switch. Do not use an extension cord.

**NOTE:** Before performing any type of installation, cleaning, or removing a light bulb, turn the control, (Thermostat, Refrigerator or Freezer Control depending on the model) to OFF and then disconnect the refrigerator from the electrical source. When you are finished, reconnect the refrigerator to the electrical source and reset the control (Thermostat, Refrigerator or Freezer Control depending on the model) to the desired setting.

## Water Supply Requirements

Read all directions carefully before you begin.

#### IMPORTANT:

- If you turn the refrigerator on before the water line is connected, turn the ice maker OFF.
- All installations must meet local plumbing code requirements.
- Use copper tubing and check for leaks. Install copper tubing only in areas where the household temperatures will remain above freezing.

**TOOLS NEEDED:** Flat-blade screwdriver, 7/16" and 1/2" open-end wrenches or two adjustable wrenches, 1/4" nut driver and drill bit, hand drill or electric drill (properly grounded).

**NOTE:** Your refrigerator dealer has a kit available with a 1/4" (6.35 mm) saddle-type shutoff valve, a union, and copper tubing. Before purchasing, make sure a saddle-type valve complies with your local plumbing codes. Do not use a piercing-type or 3/16" (4.76 mm) saddle valve which reduces water flow and clogs more easily.

### Water Pressure

A cold water supply with water pressure of between 30 and 120 psi (207 - 827 kPa) is required to operate the water dispenser and ice maker. If you have questions about your water pressure, call a licensed, qualified plumber.

#### Reverse Osmosis Water Supply

**IMPORTANT:** The pressure of the water supply coming out of a reverse osmosis system going to the water inlet valve of the refrigerator needs to be between 30 and 120 psi (207 - 827 kPa). If a reverse osmosis water filtration system is connected to your cold water supply, the water pressure to the reverse osmosis system needs to be a minimum of 40 to 60 psi (276 - 414 kPa).

If the water pressure to the reverse osmosis system is less than 40 to 60 psi (276 - 414 kPa):

- Check to see whether the sediment filter in the reverse osmosis system is blocked. Replace the filter if necessary.
- Allow the storage tank on the reverse osmosis system to refill after heavy usage.
- If your refrigerator has a water filter cartridge, it may further reduce the water pressure when used in conjunction with a reverse osmosis system. Remove the water filter cartridge. See "Water Filtration System."

If you have questions about your water pressure, call a licensed, qualified plumber.

## Connect the Water Supply

(on some models)

Read all directions carefully before you begin.

**IMPORTANT:** If you turn the refrigerator on before the water line is connected, turn the ice maker OFF.

#### Connecting to Water Line:

1. Unplug refrigerator or disconnect power.
2. Turn OFF main water supply. Turn ON nearest faucet long enough to clear line of water.
3. Find a 1/2" (1.27 cm) to 1 1/4" (3.18 cm) vertical COLD water pipe near the refrigerator.

**NOTE:** Horizontal pipe will work, but the following procedure must be followed: Drill on the top side of the pipe, not the bottom. This will help keep water away from the drill. This also keeps normal sediment from collecting in the valve.

4. To determine the length of copper tubing you will need, measure from connection on lower left rear of refrigerator to water pipe. Add 7 ft (2.1 m) to allow for moving refrigerator for cleaning. Use 1/4" (6.35 mm) O.D. (outside diameter) copper tubing. Be sure both ends of copper tubing are cut square.

- Using a grounded drill, drill a 1/4" (6.35 mm) hole in the cold water pipe you have selected.

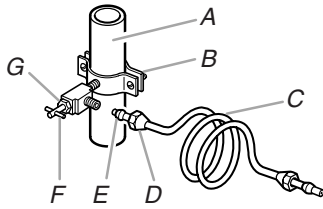

- A. Cold Water Pipe
- B. Pipe Clamp
- C. Copper Tubing
- D. Compression Nut
- E. Compression Sleeve
- F. Shutoff Valve
- G. Packing Nut

- Fasten shutoff valve to cold water pipe with pipe clamp. Be sure outlet end is solidly in the 1/4" (6.35 mm) drilled hole in the water pipe and that washer is under the pipe clamp. Tighten packing nut. Tighten the pipe clamp screws carefully and evenly so washer makes a watertight seal. Do not overtighten or you may crush the copper tubing, especially if soft (coiled) copper tubing is used. Now you are ready to connect the copper tubing.
- Slip compression sleeve and compression nut on copper tubing as shown. Insert end of tubing into outlet end squarely as far as it will go. Screw compression nut onto outlet end with adjustable wrench. Do not overtighten.
- Place the free end of the tubing into a container or sink, and turn ON main water supply and flush out tubing until water is clear. Turn OFF shutoff valve on the water pipe. Coil copper tubing.

### Connecting to Refrigerator:

**NOTE:** The first step for connecting the water line to your refrigerator is different depending on the type of water valve provided with your refrigerator. See the diagrams below to determine the style of valve you have. (On kit models, assemble water valve to refrigerator per kit instructions.)

- For **Style 1**, disconnect the tube clamp on the back of the product and insert the copper tubing through the clamp, as shown. Remove the tape label from the valve inlet and insert copper tubing until it bottoms out (approximately 3/4" [1.9 cm]). Tighten nut by hand as much as possible; then turn the nut an additional 1/2 turn using a wrench. Do not overtighten. Reattach the tube clamp and tube to the back of the cabinet. Skip to Step 2.

For **Style 2**, disconnect the tube clamp on the back of the product and insert copper tubing through the clamp as shown. Attach the copper tube to the valve inlet using a compression nut and sleeve as shown. Tighten the compression nut. Do not overtighten. Reattach the tube clamp and tube to the back of the cabinet. Move to Step 2.

### Style 1

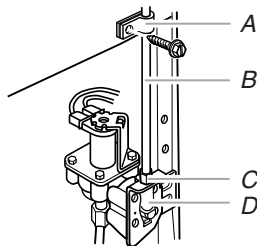

- A. Tube Clamp
- B. Copper Tubing
- C. Compression Nut
- D. Valve Inlet

### Style 2

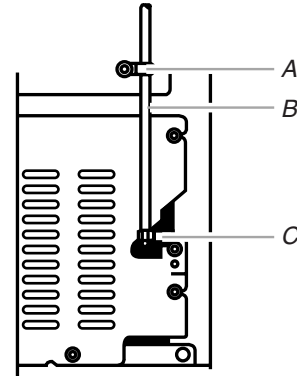

- A. Tube Clamp
- B. Copper Tubing
- C. Compression Nut

- Turn shutoff valve ON. Check for leaks. Tighten any connections (including connections at the valve) or nuts that leak.
- The ice maker is equipped with a built-in water strainer. If local water conditions require periodic cleaning or a well is your source of water supply, a second water strainer should be installed in the 1/4" (6.35 mm) water line. Obtain a water strainer from your nearest appliance dealer. Install at either tube connection.
- Plug in refrigerator or reconnect power.

## Refrigerator Doors

**TOOLS NEEDED:** 5/16" hex-head socket wrench, #2 Phillips screwdriver, flat-blade screwdriver, 5/16" open-end wrench, flat 2" putty knife.

### IMPORTANT:

- Before you begin, turn the refrigerator control OFF, unplug refrigerator or disconnect power. Remove food and any adjustable door or utility bins from doors.
- If you are only removing and replacing the doors, the instructions are the same regardless of door style. See "Remove Doors and Hinges" and "Replace Doors and Hinges" later in this section.
- Depending on your model, you may have standard **Style 1** or contour **Style 2** doors. If you are also going to reverse the door swing, follow the instructions for the appropriate door style.
- All graphics referenced in the following instructions are included later in this section after "Final Steps."

### Remove Doors and Hinges

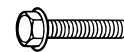

5/16" Hex-Head Hinge Screw

- Unplug refrigerator or disconnect power.
- Open refrigerator door and remove base grille from the bottom front of the refrigerator. See Base Grille graphic.
- Close the refrigerator door and keep both doors closed until you are ready to lift them free from the cabinet.

**NOTE:** Provide additional support for the doors while the hinges are being moved. Do not depend on the door magnets to hold the doors in place while you are working.

- Remove the parts for the top hinge as shown in Top Hinge graphic. Lift the freezer door free from the cabinet.
- Remove the parts for the center hinge as shown in the Center Hinge graphic. Lift the refrigerator door free from the cabinet.
- Remove the parts for the bottom hinge as shown in the Bottom Hinge graphic.

**IMPORTANT:** If you want to reverse your doors so that they open in the opposite direction, continue with the "Reverse Doors (optional)" instructions. If you are not reversing the doors, see "Replace Doors and Hinges."

---

## Reverse Doors (optional)

---

### Style 1—Standard Doors

See complete **Style 1** graphics later in this section.



Door Stop Screw



Door Handle Sealing Screw



Flat-Head Handle Screw



Door Handle Seal Screw Front



Door Hinge Hole Plug



Cabinet Hinge Hole Plug



Door Handle Screw Cover



Round-Head Handle Screw

### Cabinet

- Remove 5/16" hex-head hinge screws from handle side and move them to opposite side. See Graphic 1-1.
- Remove cabinet hinge hole plugs from cabinet top and move them to opposite side hinge holes as shown in Graphic 1-2.

### Freezer Door

- Remove freezer handle assembly as shown. Keep all parts together. See Graphic 2.
- Remove door hinge hole plug. Move to opposite side as shown in Graphic 3.
- Remove door handle sealing screws. Move to opposite side of freezer door as shown in Graphic 4.
- Remove door stop. Move to opposite side of freezer door as shown in Graphic 5.
- Position handle on opposite side of freezer door. Assemble handles on door as shown in Graphic 2.
- Tighten all screws. Set aside door until hinges and refrigerator compartment door are in place.

### Refrigerator Door

- Remove refrigerator handle assembly as shown. Keep all parts together. See Graphic 6-1.
- Remove shoulder handle screw from refrigerator door as shown. Keep all parts together. See Graphic 6-2.
- Remove door hinge hole plug from refrigerator door. Move to opposite side hinge hole as shown in Graphic 3.
- Remove door handle sealing screws. Move to opposite side of refrigerator door as shown in Graphic 4.
- Remove door handle seal screw front. Move to opposite side of refrigerator door as shown in Graphic 7.
- Position shoulder handle screw on opposite side of refrigerator door and drive screw as show in Graphic 6-2.

- Remove door stop. Move to opposite side of refrigerator door as shown in Graphic 5.
- Position refrigerator handle on opposite side of the refrigerator door as shown in Graphic 6-3. Drive top two screws in handle first. Align lower portion of handle and drive bottom screw.
- Tighten all screws. Set aside refrigerator door until bottom hinge is installed on refrigerator.

### Style 2—Contour Doors

See complete **Style 2** graphics later in this section.



Round-Head Handle Screw



Door Handle Screw Hole Plug



Door Hinge Hole Plug

### Cabinet

- Remove 5/16" hex-head hinge screws from handle side and move them to opposite side. See Graphic 1-1.
- Remove cabinet hinge hole plugs from the cabinet top and move them to opposite side hinge holes as shown in Graphic 1-2.

### Doors

- Remove door hinge hole plug from top of freezer door. Move to opposite side as shown in Graphic 2.
- Remove door stop from both the freezer and refrigerator doors and move to the other side. See Graphic 3.

---

## Replace Doors and Hinges

---

**NOTE:** Graphic may be reversed if door swing is reversed.

- Replace the parts for the bottom hinge as shown. Tighten screws. Replace the refrigerator door.
 

**NOTE:** Provide additional support for the doors while the hinges are being moved. Do not depend on the door magnets to hold the doors in place while you are working.
- Assemble the parts for the center hinge as shown and tighten all screws. See Center Hinge graphic. Replace the freezer door.
- Assemble the parts for the top hinge as shown in the Top Hinge graphic. Do not tighten the screws completely.
- Line up the doors so that the bottom of the freezer door aligns evenly with the top of the refrigerator door. Tighten all screws.

---

## Final Steps

---

- Check all holes to make sure that hole plugs and screws are in place. Reinstall top hinge cover. See Top Hinge graphic.
 

**NOTE:** On the left-hand side of the base grille there is a removable tab which is a bottom hinge hole plug. Break off the tab from the base grille and insert the bottom hinge hole plug into the bottom hinge holes. See Base Grille graphic.
- Replace the base grille. See Base Grille graphic.
- Plug in refrigerator or reconnect power.
- Reset the controls. See "Using the Controls."
- Return all removable door parts to doors and food to refrigerator.

**Door Removal & Replacement**

**Base Grille**

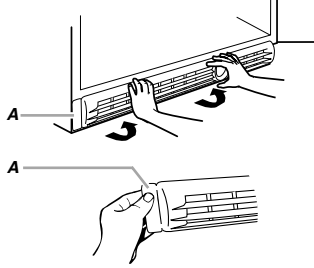

A. Bottom Hinge Hole Plug

**Top Hinge**

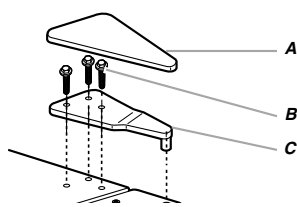

A. Top Hinge Cover  
B. 5/16" Hex-Head Hinge Screws  
C. Top Hinge

**Center Hinge**

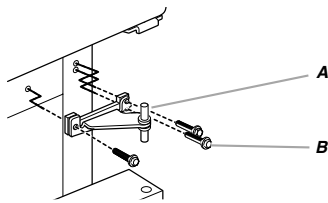

A. Center Hinge  
B. 5/16" Hex-Head Hinge Screws

**Bottom Hinge**

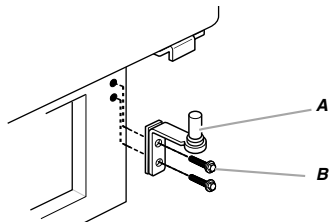

A. Bottom Hinge  
B. 5/16" Hex-Head Hinge Screws

**Door Swing Reversal (optional)**

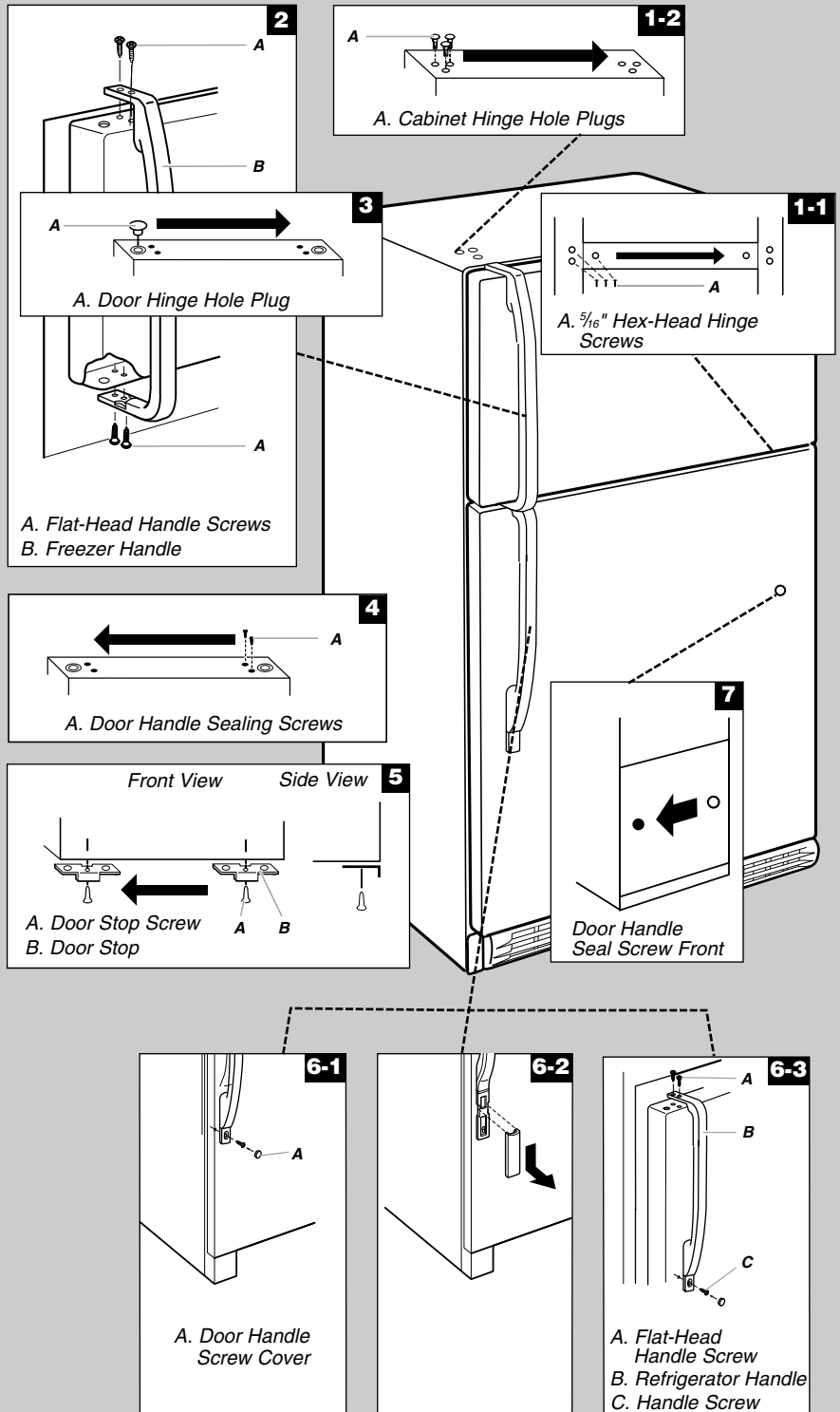



## Style 2—Contour Door

### Door Removal & Replacement

#### Base Grille

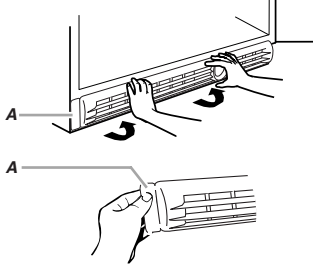

A. Bottom Hinge Hole Plug

#### Top Hinge

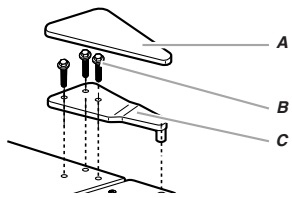

A. Top Hinge Cover  
B.  $\frac{5}{16}$ " Hex-Head Hinge Screws  
C. Top Hinge

#### Center Hinge

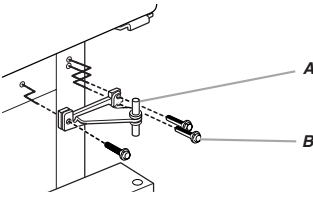

A. Center Hinge  
B.  $\frac{5}{16}$ " Hex-Head Hinge Screws

#### Bottom Hinge

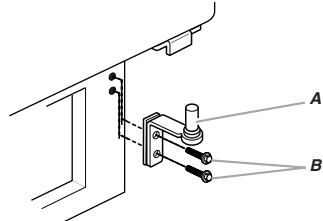

A. Bottom Hinge  
B.  $\frac{5}{16}$ " Hex-Head Hinge Screws

### Door Swing Reversal (optional)

**1-1**

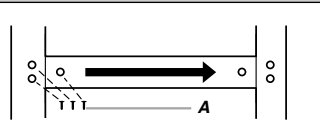

A.  $\frac{5}{16}$ " Hex-Head Hinge Screws

**1-2**

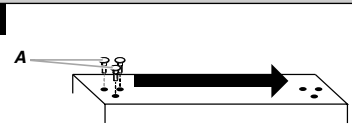

A. Cabinet Hinge Hole Plugs

**2**

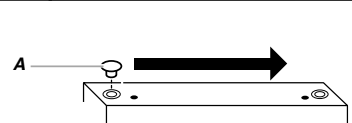

A. Door Hinge Hole Plug

**3**

#### Removal of Door Stops

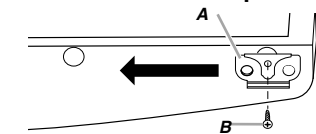

A. Door Stop  
B. Door Stop Screw

**4**

#### Reinstallation of Door Stops

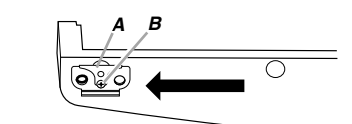

A. Door Stop  
B. Door Stop Screw

---

## Adjust the Doors

---

### Door Closing

---

Your refrigerator has two front adjustable rollers – one on the right and one on the left. If your refrigerator seems unsteady or you want the doors to close easier, adjust the refrigerator's tilt using the instructions below:

1. Plug into a grounded 3 prong outlet.
2. Move the refrigerator into its final location.
3. Remove the base grille. See Base Grille graphic. The two leveling screws are part of the front roller assemblies which are at the base of the refrigerator on either side.
4. Use a screwdriver to adjust the leveling screws. Turn the leveling screw to the right to raise that side of the refrigerator or turn the leveling screw to the left to lower that side. It may take several turns of the leveling screws to adjust the tilt of the refrigerator.

**NOTE:** Having someone push against the top of the refrigerator takes some weight off the leveling screws and rollers. This makes it easier to adjust the screws.

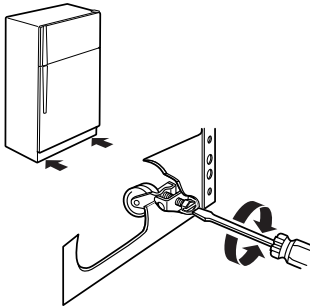

5. Open both doors again and check to make sure that they close as easily as you like. If not, tilt the refrigerator slightly more to the rear by turning both leveling screws to the right. It may take several more turns, and you should turn both leveling screws the same amount.
6. Replace the base grille.

---

### Align Doors

---

If the space between your doors looks uneven, you can adjust it using the instructions below:

1. Pry off the top hinge cover.
2. Loosen the top hinge screws using a  $\frac{5}{16}$ " socket or wrench.
3. Have someone hold the door in place or put a spacer between the doors while you tighten the top hinge screws.
4. Replace the top hinge cover.

---

## Normal Sounds

Your new refrigerator may make sounds that your old one didn't make. Because the sounds are new to you, you might be concerned about them. Most of the new sounds are normal. Hard surfaces, such as the floor, walls, and cabinets, can make the sounds seem louder. The following describes the kinds of sounds and what may be making them.

- If your refrigerator is equipped with an ice maker, you will hear a buzzing sound when the water valve opens to fill the ice maker for each cycle.

- Your refrigerator is designed to run more efficiently to keep your food items at the desired temperatures and to minimize energy usage. The high efficiency compressor and fans may cause your refrigerator to run longer than your old one. You may also hear a pulsating or high-pitched sound from the compressor or fans adjusting to optimize performance.
- You may hear the evaporator fan motor circulating air through the refrigerator and freezer compartments. The fan speed may increase as you open the doors or add warm food.
- Rattling noises may come from the flow of refrigerant, the water line, or items stored on top of the refrigerator.
- Water dripping on the defrost heater during a defrost cycle may cause a sizzling sound.
- As each cycle ends, you may hear a gurgling sound due to the refrigerant flowing in your refrigerator.
- Contraction and expansion of the inside walls may cause a popping noise.
- You may hear air being forced over the condenser by the condenser fan.
- You may hear water running into the drain pan during the defrost cycle.

---

## REFRIGERATOR USE

---

### Ensuring Proper Air Circulation

In order to ensure proper temperatures, you need to permit airflow between the refrigerator and freezer sections. As shown in the illustration, cool air enters through the bottom of the freezer section and moves up. Most of the air then flows through the freezer section vents and recirculates under the freezer floor. The rest of the air enters the refrigerator section through the top vent.

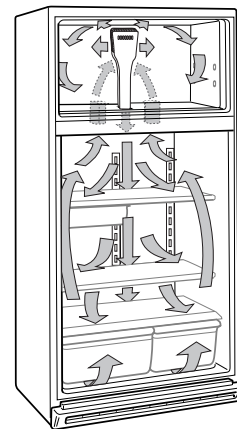

Do not block any of these vents with food packages. If the vents are blocked, airflow will be prevented and temperature and moisture problems may occur.

**IMPORTANT:** Because air circulates between both sections, any odors formed in one section will transfer to the other. You must thoroughly clean both sections to eliminate odors. To prevent odor transfer and drying out of food, wrap or cover foods tightly.

## Using the Controls

For your convenience, your refrigerator controls are preset at the factory. When you first install your refrigerator, make sure that the controls are still preset to the mid-settings as shown.

**NOTE:** To turn your refrigerator off, turn the refrigerator control to the word OFF or until the word OFF appears. Your product will not cool when the refrigerator control is set to OFF.

### Mid-setting "3"

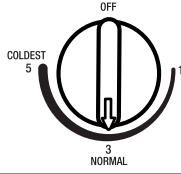

### Mid-setting "3"

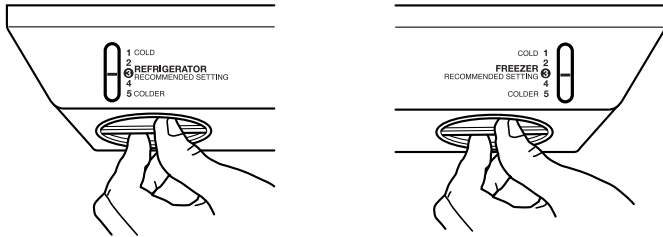

### Mid-setting "4"

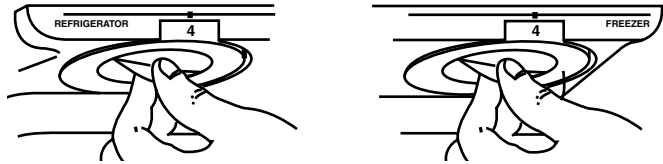

### IMPORTANT:

- Give your refrigerator time to cool down completely before adding food. It is best to wait 24 hours before you put food into the refrigerator.
- If you add food before the refrigerator has cooled completely, your food may spoil. Adjusting the Refrigerator and Freezer Controls to a higher (colder) than recommended setting will not cool the compartments any faster.

## Adjusting Control Settings

The mid-setting(s) indicated in the previous section should be correct for normal household usage. The controls are set correctly when milk or juice is as cold as you like and when ice cream is firm.

If the temperature is too warm or too cold in the refrigerator or freezer, first check the air vents to be sure they are not blocked.

If you need to adjust temperatures, use the settings listed in the chart below as a guide. On models with two controls, adjust the refrigerator temperature first. Wait at least 24 hours between adjustments and then recheck the temperatures.

CONDITION/REASON:	ADJUSTMENT:
<b>REFRIGERATOR section too warm</b> <ul style="list-style-type: none"> <li>■ Door opened often, large amount of food added or room temperature very warm</li> </ul>	Adjust REFRIGERATOR or TEMPERATURE Control one setting higher
<b>FREEZER section too warm/ice not made fast enough</b> <ul style="list-style-type: none"> <li>■ Door opened often, or large amount of food added or very cold room temperature (can't cycle often enough)</li> <li>■ Heavy ice usage</li> </ul>	Adjust FREEZER or TEMPERATURE Control one setting higher
<b>REFRIGERATOR section too cold</b> <ul style="list-style-type: none"> <li>■ Controls not set correctly for your conditions</li> </ul>	Adjust REFRIGERATOR or TEMPERATURE Control one setting lower
<b>FREEZER section too cold</b> <ul style="list-style-type: none"> <li>■ Controls not set correctly for your conditions</li> </ul>	Adjust FREEZER or TEMPERATURE Control one setting lower

## Ice Maker

(on some models - Accessory)

### Turning the Ice Maker On/Off

**NOTE:** Do not force the wire shutoff arm up or down.

- To turn the ice maker on, simply lower the wire shutoff arm.

**NOTE:** Your ice maker has an automatic shutoff. As ice is made, the ice cubes will fill the ice storage bin and the ice cubes will raise the wire shutoff arm to the OFF (arm up) position.

- To manually turn the ice maker off, lift the wire shutoff arm to the OFF (arm up) position and listen for the click to make sure the ice maker will not continue to operate.

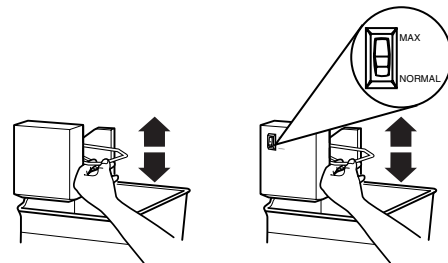

---

## Ice Production Rate

---

- **NORMAL Ice Production:** The ice maker should produce approximately 8 to 12 batches of ice in a 24-hour period. If ice is not being made fast enough, turn the Freezer Control toward a higher (colder) number in half number steps. (For example, if the control is at 3, move it to between 3 and 4.) Wait 24 hours and, if necessary, gradually turn the Freezer Control to the highest setting, waiting 24 hours between each increase.
- **MAXIMUM Ice Production (on some models):** The ice maker should produce approximately 16 to 20 batches of ice in a 24-hour period. If your refrigerator has the maximum ice production feature, push the switch to MAX.

---

## Remember

---

- Allow 24 hours to produce the first batch of ice. Discard the first three batches of ice produced.
- The quality of your ice will be only as good as the quality of the water supplied to your ice maker. Avoid connecting the ice maker to a softened water supply. Water softener chemicals (such as salt) can damage parts of the ice maker and lead to poor quality ice. If a softened water supply cannot be avoided, make sure the water softener is operating properly and is well maintained.
- Do not store anything on top of the ice maker or in the ice storage bin.

---

# REFRIGERATOR FEATURES

Your model may have some or all of these features. Features that can be purchased separately as product accessories are labeled with the word "Accessory." Not all accessories will fit all models. If you are interested in purchasing one of the accessories, please call the toll-free number on the cover or in the "Assistance or Service" section.

### Important information to know about glass shelves and covers:

Do not clean glass shelves or covers with warm water when they are cold. Shelves and covers may break if exposed to sudden temperature changes or impact, such as bumping. For your protection, tempered glass is designed to shatter into many small, pebble-size pieces. This is normal. Glass shelves and covers are heavy. Use special care when removing them to avoid impact from dropping.

---

## Refrigerator Shelves

Your model may have glass or wire shelves. Store similar foods together and adjust the shelves to fit different heights. This reduces the time the refrigerator door is open and saves energy.

---

### Slide-out Shelves (on some models)

---

#### To Remove and Replace a Shelf in a Metal Frame:

1. Pull the shelf forward to the stop. Tilt the front of the shelf up and lift it slightly as you pull the shelf from the frame.
2. Replace the shelf by guiding it back into the slots on the frame and pushing the shelf in past the stop.

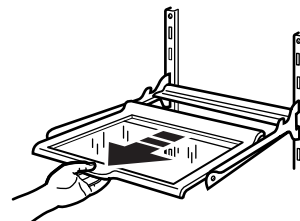

---

### Shelves and Shelf Frames

---

#### To Remove and Replace a Shelf/Frame:

1. Remove the shelf/frame by tilting it up at the front and lifting it out of the shelf supports.
2. Replace the shelf/frame by guiding the rear shelf hooks into the shelf supports. Tilt the front of the shelf up until rear shelf hooks drop into the shelf supports. Check to make sure that the shelf is securely in position.

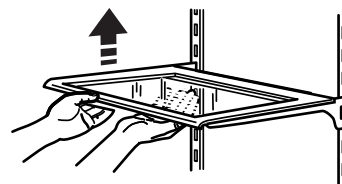

---

## Crispers and Meat Drawers

(on some models)

---

---

### Drawers

---

#### To Remove and Replace a Drawer:

1. Slide drawer straight out to the stop. Lift the front of the drawer and slide it out the rest of the way.
2. Replace a drawer by sliding it back in fully past the stop.

---

### Crisper Cover

---

#### To Remove the Crisper(s) Cover:

1. Remove crisper(s). Hold the glass insert firmly with one hand and press up in the center of the glass insert until it rises above the plastic frame. Carefully slide the glass insert forward to remove.
2. Lift the cover frame and remove it.

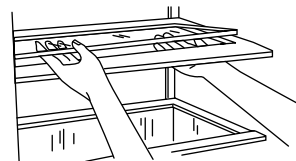

## To Replace the Crisper(s) Cover:

**NOTE:** Before reinstalling the cover, make sure the U-shaped reinforcement bar is reinstalled in the front edge of the crisper cover.

1. Fit back of cover frame into supports on side walls of the refrigerator and lower the front of the cover frame into place.
2. Slide rear of glass insert into cover frame and lower front into place.

## Meat Drawer Cover

### To Remove and Replace the Meat Drawer Cover:

#### Style 1–Glass

1. Remove the meat drawer. Tilt up the front of the cover and lift at the back. Pull the cover straight out.
2. Replace the cover by guiding the rear hooks into the shelf supports. Tilt the cover up at the front until the rear hooks drop into the slots. Lower the front of the cover to a level position and replace the meat drawer.

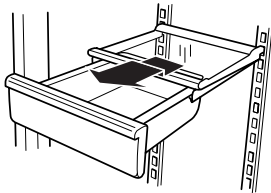

#### Style 2–Plastic

1. Remove the meat drawer. Tilt the cover up at the front and pull it forward and out.
2. Replace the meat drawer cover by fitting the notches and rear edge of the cover over rear and center crossbars on the shelf. Lower cover into place and replace the meat drawer.

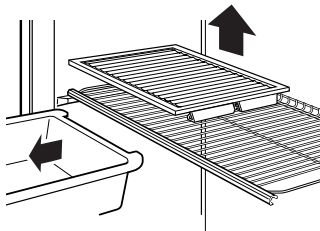

## Crisper Humidity Control

(on some models)

You can adjust the amount of humidity in the moisture-sealed crisper using the settings between HIGH and LOW.

LOW (open) lets moist air out of the crisper for best storage of fruits and vegetables with skins.

- Fruit: Wash, let dry and store in refrigerator in plastic bag in crisper. Do not wash or hull berries until they are ready to use. Sort and keep berries in original container in crisper.
- Vegetables with skins: Place in plastic bag or plastic container and store in crisper.

HIGH (closed) keeps moist air in the crisper for best storage of fresh, leafy vegetables.

- Leafy vegetables: Wash in cold water, drain and trim or tear off bruised and discolored areas. Place in plastic bag or plastic container and store in crisper.

## Humidity Control Location

Humidity Control on crisper drawer

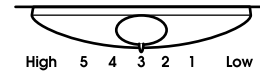

## Chilled Meat Drawer

(on some models)

Slide the meat drawer temperature control forward to make the meat drawer less cold or backward to make the drawer more cold.

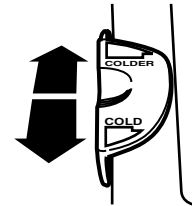

## Meat Storage Guide

Store most meat in original wrapping as long as it is airtight and moisture-proof. Rewrap if necessary. See the following chart for storage times. When storing meat longer than the times given, freeze the meat.

Fresh fish or shellfish..... use same day as purchased  
Chicken, ground beef, variety meats (liver) ..... 1-2 days  
Cold cuts, steaks/roasts ..... 3-5 days  
Cured meats ..... 7-10 days  
Leftovers - Cover leftovers with plastic wrap, aluminum foil, or plastic containers with tight lids.

## Wine or Can/Bottle Rack

(on some models - Accessory)

### To Remove and Replace the Wine Rack (left) or Can/Bottle Rack (right):

1. Remove the rack by pulling it straight out from the shelf.
2. Replace the rack by sliding it in between the shelf and the wall of the refrigerator.

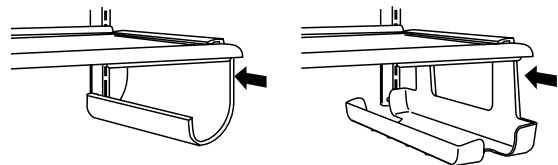

## Utility or Egg Bin

(on some models - Accessory)

Depending on your model, you may have a one-, two- or three-piece bin. Eggs may be stored in the egg tray or loose in the bin.

**NOTE:** Store eggs in a covered container for long-term storage. If your model does not have an egg storage bin, store eggs in their original carton on an interior shelf.

---

## FREEZER FEATURES

Your model may have some or all of these features. Features that can be purchased separately as product accessories are labeled with the word "Accessory." Not all accessories will fit all models. If you are interested in purchasing one of the accessories, please call the toll-free number on the cover or in the "Assistance or Service" section.

---

### Freezer Shelf (on some models)

#### To Remove and Replace the Shelf:

1. Remove the shelf by lifting the entire shelf slightly and move it all the way to one side. Tilt the other side up and out of the shelf supports.
2. Replace the shelf by inserting one end all the way into the center of the shelf supports. Then, lower the other end of the shelf and insert it into the shelf supports.

**NOTE:** The shelf should lower slightly and lock into place. If the shelf does not appear stable, make sure both ends of the shelf are inserted into the shelf supports.

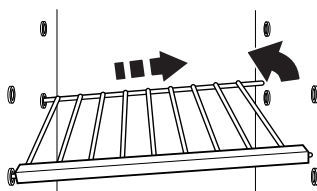

---

### Frozen Food Storage Guide

Storage times will vary according to the quality and type of food, the type of packaging or wrap used (should be airtight and moisture-proof), and the storage temperature. Seal the package or container securely to prevent taste and odor transfer throughout the product. Ice crystals inside a sealed package are normal.

Put no more unfrozen food into the freezer than will freeze within 24 hours (no more than 2 to 3 lbs. of food per cubic foot [907-1,350 g per 28 L] of freezer space). Leave enough space in the freezer for air to circulate around packages. The freezer door must close tightly. For more information on preparing food for freezing, check a freezer guide or reliable cookbook.

---

### Pull-out Freezer Floor (on some models)

#### To Remove and Replace the Freezer Floor:

1. Lift both back "fences" up and out.
2. Remove the freezer floor by pulling it out about 1" (2.5 cm) with one hand around the air tower section (center back) and one hand at center front.
3. Lift up floor at rear until hooks release from cabinet and pull the floor out the rest of the way.
4. Replace the freezer floor by sliding the floor straight in until the hooks drop into place at rear of cabinet.

5. Replace "fences" by aligning pins with socket in the floor, and pushing down until they snap into place.

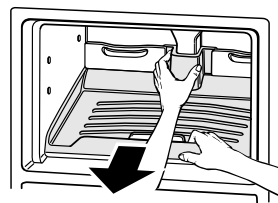

---

## DOOR FEATURES

Your model may have some or all of these features. Features that can be purchased separately as product accessories are labeled with the word "Accessory." Not all accessories will fit all models. If you are interested in purchasing one of the accessories, please call the toll-free number on the cover or in the "Assistance or Service" section.

---

### Door Rails

The door rails may be removed for easier cleaning.

---

#### Snap-on Door Rails

#### To Remove and Replace the Rails:

1. Remove the rails by pushing in slightly on the front of the bracket while pulling out on the inside tab. Repeat these steps for the other end of the rail.
2. Replace the rails by aligning the ends of the brackets with the buttons on the sides of the door liner. Firmly snap bracket and rail assembly onto the tabs above the shelf as shown.

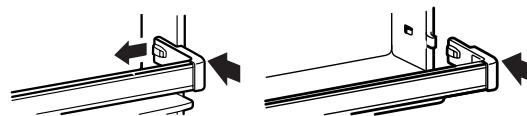

---

#### Drop-in Door Rails

#### To Remove and Replace the Rails:

1. Remove the rails by pulling straight up on each end of the rail.
2. Replace the rails by sliding the shelf rail into the slots on the door and pushing the rail straight down until it stops.

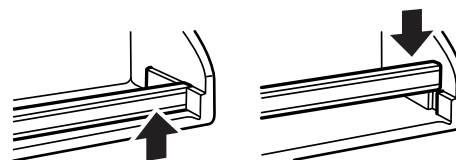

## Can Racks and Door Bins

(on some models)

**NOTE:** Can racks may be purchased as an Accessory for some models.

### To Remove and Replace the Racks/Bins:

1. Remove the rack/bin by lifting it and pulling it straight out.
2. Replace the rack/bin by sliding it in above the desired support and pushing it down until it stops.

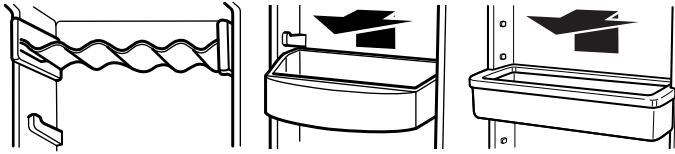

## Adjustable Utility Compartment & Tray

(on some models)

The utility compartment and tray slide from one side to the other for more flexible storage. The tray fits on either side of the utility compartment or partially underneath it. Try moving it to different positions to find the option that works best for you.

### To Install and Adjust the Utility Compartment and Tray:

1. Insert the front of the utility tray into the slot on the back of the shelf rail. Lower the back of the tray into position.
2. Place the front of the utility compartment on top of the shelf rail. Lower the back of the compartment onto the ribs on the refrigerator door.

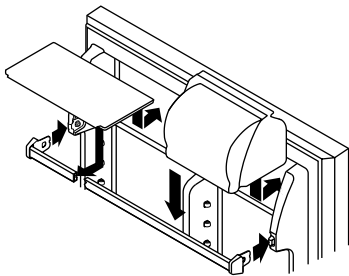

3. Adjust the utility compartment by lifting the front slightly and sliding it to the desired position. Lower the front to lock it into place.

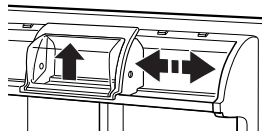

## Flip-up Door Shelf

(on some models)

The shelf bottom flips up so you can store taller items in the door shelf below. When in the down position, the shelf is strong enough to hold up to 10 lbs. (4.5 kg).

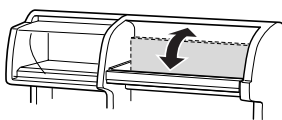

# REFRIGERATOR CARE

## Cleaning

### ⚠ WARNING



#### Explosion Hazard

Use nonflammable cleaner.

Failure to do so can result in death, explosion, or fire.

Both the refrigerator and freezer sections defrost automatically. However, clean both sections about once a month to prevent odors from building up. Wipe up spills immediately.

### To Clean Your Refrigerator:

1. Unplug refrigerator or disconnect power.
2. Remove all removable parts from inside, such as shelves, crispers, etc.
3. Hand wash, rinse, and dry removable parts and interior surfaces thoroughly. Use a clean sponge or soft cloth and a mild detergent in warm water.
  - Do not use abrasive or harsh cleaners such as window sprays, scouring cleansers, flammable fluids, cleaning waxes, concentrated detergents, bleaches or cleansers containing petroleum products on plastic parts, interior and door liners or gaskets. Do not use paper towels, scouring pads, or other harsh cleaning tools. These can scratch or damage materials.
  - To help remove odors, you can wash interior walls with a mixture of warm water and baking soda (2 tbs. to 1 qt. [26 g to 0.95 L] of water).
4. Determine whether your refrigerator exterior is painted metal, brushed aluminum or stainless steel and choose the appropriate cleaning method.

**Painted metal:** Wash exteriors with a clean sponge or soft cloth and a mild detergent in warm water. Do not use abrasive or harsh cleaners, or cleaners designed for stainless steel. Dry thoroughly with a soft cloth. For additional protection against damage to painted metal exteriors, apply appliance wax (or auto paste wax) with a clean, soft cloth. Do not wax plastic parts.

**Brushed aluminum:** Wash with a clean sponge or soft cloth and a mild detergent in warm water. Do not use abrasive or harsh cleaners, or cleaners designed for stainless steel. Dry thoroughly with a soft cloth.

**Stainless steel finish:** Wash with a clean sponge or soft cloth and a mild detergent in warm water. Do not use abrasive or harsh cleaners. Dry thoroughly with a soft cloth.

- To keep your stainless steel refrigerator looking like new and to remove minor scuffs or marks, it is suggested that you use the manufacturer's approved Stainless Steel Cleaner & Polish.

**IMPORTANT:** This cleaner is for stainless steel parts only!

Do not allow the Stainless Steel Cleaner & Polish to come into contact with any plastic parts such as the trim pieces, dispenser covers or door gaskets. If accidental contact does occur, clean plastic part with a sponge and mild detergent in warm water. Dry thoroughly with a soft cloth. To order the cleaner, see the "Accessories" section.

5. There is no need for routine condenser cleaning in normal home operating environments. If the environment is particularly greasy or dusty, or there is significant pet traffic in the home, the condenser should be cleaned every 2 to 3 months to ensure maximum efficiency.

If you need to clean the condenser:

- Remove the base grille. See "Base Grille" graphic or "Base Grille" section.
  - Use a vacuum cleaner with a soft brush to clean the grille, the open areas behind the grille and the front surface area of the condenser.
  - Replace the base grille when finished.
6. Plug in refrigerator or reconnect power.

## Changing the Light Bulbs

**NOTE:** Not all bulbs will fit your refrigerator. Be sure to replace the bulb with one of the same size, shape, and wattage.

1. Unplug refrigerator or disconnect power.
2. Remove the bulb from behind the control panel in the refrigerator or from behind the light shield in the freezer (on some models). Replace it with a bulb of 25W.
3. Plug in refrigerator or reconnect power.

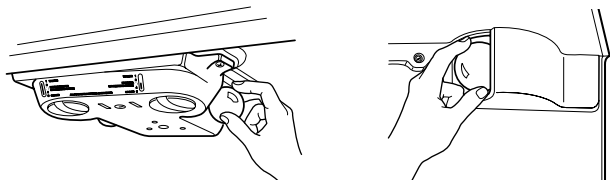

## Power Interruptions

If the power will be out for 24 hours or less, keep the door or doors closed (depending on your model) to help food stay cold and frozen.

If the power will be out for more than 24 hours, do one of the following:

- Remove all frozen food and store it in a frozen food locker.
- Place 2 lbs. (907 g) of dry ice in the freezer for every cubic foot (28 L) of freezer space. This will keep the food frozen for 2 to 4 days.
- If neither a food locker nor dry ice is available, consume or can perishable food at once.

**REMEMBER:** A full freezer stays cold longer than a partially filled one. A freezer full of meat stays cold longer than a freezer full of baked goods. If you see that food contains ice crystals, it may be refrozen, although the quality and flavor may be affected. If the condition of the food is poor, dispose of it.

## Holiday and Moving Care

### Holidays

If you choose to leave the refrigerator on while you're away, use these steps to prepare your refrigerator before you leave.

1. Use up any perishables and freeze other items.
2. If your refrigerator has an automatic ice maker:
  - Raise wire shutoff arm to OFF (up) position.
  - Shut off water supply to the ice maker.
3. Empty the ice bin.

If you choose to turn the refrigerator off before you leave, follow these steps.

1. Remove all food from the refrigerator.
2. If your refrigerator has an automatic ice maker:
  - Turn off the water supply to the ice maker at least one day ahead of time.
  - When the last load of ice drops, raise the wire shutoff arm to the OFF (up) position.
3. Depending on your model, turn the Thermostat Control (or Refrigerator Control, depending on the model) to OFF. See the "Setting or Using the Controls" section.
4. Clean refrigerator, wipe it, and dry well.
5. Tape rubber or wood blocks to the tops of both doors to prop them open far enough for air to get in. This stops odor and mold from building up. Take care not to damage the door seal with the blocks.

### Moving

When you are moving your refrigerator to a new home, follow these steps to prepare it for the move.

1. If your refrigerator has an automatic ice maker:
  - Turn off the water supply to the ice maker at least one day ahead of time.
  - Disconnect the water line from the back of the refrigerator.
  - When the last load of ice drops, raise the wire shutoff arm to the OFF (up) position.
2. Remove all food from the refrigerator and pack all frozen food in dry ice.
3. Depending on your model, turn the Thermostat Control (or Refrigerator Control, depending on the model) to OFF. See the "Setting or Using the Controls" section.
4. Unplug the refrigerator.
5. Empty water from the defrost pan located behind the base grille.
6. Clean, wipe, and dry thoroughly.
7. Take out all removable parts, wrap them well, and tape them together so they don't shift and rattle during the move.
8. Depending on the model, raise the front of the refrigerator so it rolls more easily OR screw in the leveling legs so they don't scrape the floor. See the "Door Closing" section.
9. Tape the doors shut and the power cord to the refrigerator cabinet.

When you get to your new home, put everything back and refer to the "Refrigerator Installation" section for preparation instructions. Also, if your refrigerator has an automatic ice maker, remember to reconnect the water supply to the refrigerator.



---

# TROUBLESHOOTING

Try the solutions suggested here first in order to avoid the cost of an unnecessary service call.

---

## Your refrigerator will not operate

- **Is the power supply cord unplugged?** Plug into a grounded 3 prong outlet.
- **Has a household fuse blown or circuit breaker tripped?** Replace the fuse or reset the circuit.
- **Is the Refrigerator Control turned to the OFF position?** See “Using the Control(s),” depending on the model.
- **Is the refrigerator defrosting?** Recheck to see whether the refrigerator is operating in 30 minutes. Your refrigerator will regularly run an automatic defrost cycle.

---

## The lights do not work

- **Is the power supply cord unplugged?** Plug into a grounded 3 prong outlet.
- **Is a light bulb loose in the socket?** Turn the refrigerator control to OFF. Disconnect the refrigerator from the electrical supply. Gently remove the bulb and reinsert. Then reconnect the refrigerator to the electrical supply and reset the refrigerator control.
- **Has a light bulb burned out?** Replace with an appliance bulb of the same wattage, size, and shape. See “Changing the Light Bulb(s),” depending on the model.

---

## There is water in the defrost drain pan

- **Is the refrigerator defrosting?** The water will evaporate. It is normal for water to drip into the defrost pan.
- **Is it more humid than normal?** Expect that the water in the defrost pan will take longer to evaporate. This is normal when it is hot or humid.

---

## The motor seems to run too much

- **Is the room temperature hotter than normal?** Expect the motor to run longer under warm conditions. At normal room temperatures, expect your motor to run about 40% to 80% of the time. Under warmer conditions, expect it to run even more of the time.
- **Has a large amount of food just been added to the refrigerator?** Adding a large amount of food warms the refrigerator. It is normal for the motor to run longer in order to cool the refrigerator back down. See “Refrigerator Features.”
- **Are the doors opened often?** Expect the motor to run longer when this occurs. In order to conserve energy, try to get everything you need out of the refrigerator at once, keep food organized so it is easy to find, and close the door as soon as the food is removed.
- **Is the control set correctly for the surrounding conditions?** See “Using the Control(s),” depending on the model.

- **Are the doors closed completely?** Push the doors firmly shut. If they will not shut all the way. See “The doors will not close completely” later in this section.
- **Are the condenser coils dirty?** This prevents air transfer and makes the motor work harder. Clean the condenser coils. See “Cleaning.”

**NOTE:** Your new refrigerator will run longer than your old one due to its high-efficiency motor.

---

## The refrigerator seems to make too much noise

- **The sounds may be normal for your refrigerator.** See “Normal Sounds.”

---

## The ice maker is not producing ice (on some models)

- **Is the freezer temperature cold enough to produce ice?** Wait 24 hours after hookup for ice production. See “Using the Control(s),” depending on the model.
- **Is the wire shutoff arm in the OFF (arm up) position?** Lower the wire shutoff arm to the ON (arm down) position. See “Ice Maker.”
- **Is the water line shutoff valve to the refrigerator turned on?** Turn on the water valve. See “Connect the Water Supply.”
- **Is an ice cube jammed in the ejector arm?** Remove the ice from the ejector arm with a plastic utensil. See “Ice Maker.”
- **Does the ice maker mold have water in it or has no ice been produced?** Check to see that your refrigerator has been connected to your home water supply and the supply shutoff valve is turned on. See “Connect the Water Supply.”

**NOTE:** If not due to any of the above, there may be a problem with the water line. Call for service.

---

## The ice maker is producing too little ice (on some models)

- **Has the ice maker just been installed?** Wait 72 hours for full ice production to begin. Once your refrigerator is cooled down, the ice maker should begin producing 70 to 120 cubes every 24 hours.
- **Has a large amount of ice just been removed?** Allow 24 hours for ice maker to produce more ice.
- **Is the control set correctly?** See “Using the Control(s),” depending on the model.
- **Is the water shutoff valve turned completely on?** Turn valve on fully. See “Connect the Water Supply.”
- **Is there a water filter installed on the refrigerator?** This filter may be clogged or installed incorrectly. First, check the filter installation instructions to ensure that the filter was installed correctly and is not clogged. If installation or clogging is not a problem, call a technician or other qualified person.
- **Is a reverse osmosis water filtration system connected to your cold water supply?** See “Water Supply Requirements.”

---

### Off-taste or gray color in the ice (on some models)

---

- **Are the plumbing connections new, causing discolored or off-flavored ice?** Discard the first few batches of ice.
- **Have the ice cubes been stored for too long?** Throw away old ice and make a new supply.
- **Has food in the refrigerator been wrapped properly?** See “Refrigerator Features.”
- **Do the freezer and ice bin need to be cleaned?** See “Cleaning.”
- **Does the water contain minerals (such as sulfur)?** A filter may need to be installed to remove the minerals.

---

### The divider between the two compartments is warm

---

The warmth is probably due to normal operation of the automatic exterior moisture control. If still concerned, call for service.

---

### Temperature is too warm

---

- **Are the air vents blocked in either compartment?** This prevents the movement of cold air from the freezer to the refrigerator. Remove any objects from in front of the air vents. See “Ensuring Proper Air Circulation” for the location of air vents.
- **Are the door(s) opened often?** Be aware that the refrigerator will warm when this occurs. In order to keep the refrigerator cool, try to get everything you need out of the refrigerator at once, keep food organized so it is easy to find, and close the door as soon as the food is removed.
- **Has a large amount of food just been added to the refrigerator or freezer?** Adding a large amount of food warms the refrigerator. It can take several hours for the refrigerator to return to the normal temperature.
- **Are the controls set correctly for the surrounding conditions?** See “Using the Control(s),” depending on the model.

---

### There is interior moisture buildup

---

- **Are the air vents blocked in the refrigerator?** Remove any objects from in front of the air vents. See “Ensuring Proper Air Circulation” for the location of air vents.
- **Are the door(s) opened often?** To avoid humidity buildup, try to get everything you need out of the refrigerator at once, keep food organized so it is easy to find, and close the door as soon as the food is removed. When the door is opened, humidity from the room air enters the refrigerator. The more often the door is opened, the faster humidity builds up, especially when the room itself is very humid.
- **Is the room humid?** It is normal for moisture to build up inside the refrigerator when the room air is humid.

- **Is the food packaged correctly?** Check that all food is securely wrapped. Wipe off damp food containers before placing in the refrigerator.
- **Are the controls set correctly for the surrounding conditions?** See “Using the Control(s),” depending on the model.
- **Was a self-defrost cycle completed?** It is normal for droplets to form on the back wall after the refrigerator self-defrosts.

---

### The doors are difficult to open

---

- **Are the gaskets dirty or sticky?** Clean gaskets and the surface that they touch. Rub a thin coat of paraffin wax on the gaskets following cleaning.

---

### The doors will not close completely

---

- **Are food packages blocking the door open?** Rearrange containers so that they fit more tightly and take up less space.
- **Is the ice bin out of position?** Push the ice bin in all the way.
- **Are the crisper cover, pans, shelves, bins, or baskets out of position?** Put the crisper cover and all pans, shelves, bins, and baskets back into their correct positions. See “Refrigerator Features.”
- **Are the gaskets sticking?** Clean gaskets and the surface that they touch. Rub a thin coat of paraffin wax on the gaskets following cleaning.
- **Does the refrigerator wobble or seem unstable?** Level the refrigerator. See “Door Closing.”
- **Were the doors removed during product installation and not properly replaced?** Remove and replace the doors according to “Refrigerator Doors,” or call a qualified service technician.

---

## ASSISTANCE OR SERVICE

Before calling for assistance or service, please check “Troubleshooting.” It may save you the cost of a service call. If you still need help, follow the instructions below.

Contact the dealer from whom you purchased the unit or a Whirlpool designated service company.

When asking for help or service, please provide a detailed description of the problem, your model’s complete model and serial numbers, and the purchase date. This information will help us to better respond to your request. You can find this information on the model and serial number label located on the inside wall of the refrigerator compartment.

### If you need replacement parts

Look for quality replacement parts whenever you need a replacement part for your Whirlpool appliance.

To locate factory specified replacement parts in your area, contact the dealer from whom you purchased your unit or a Whirlpool designated service center.

---

## Notes

---

# WHIRLPOOL® REFRIGERATOR WARRANTY

---

## FULL ONE-YEAR WARRANTY ON REFRIGERATOR

For one year from the date of purchase, when this refrigerator is operated and maintained according to instructions attached to or furnished with the product, Whirlpool Corporation will pay for Factory Specified Parts and repair labor costs to correct defects in materials or workmanship. Service must be provided by a Whirlpool designated service company.

---

## FIVE-YEAR FULL WARRANTY ON SEALED REFRIGERATION SYSTEM PARTS AS LISTED

For five years from the date of purchase, when this refrigerator is operated and maintained according to instructions attached to or furnished with the product, Whirlpool Corporation will pay for Factory Specified Parts and repair labor to correct defects in materials or workmanship in the sealed refrigeration system. These parts are: compressor, evaporator, condenser, dryer, connecting tubing. Service must be provided by a Whirlpool designated service company.

---

### Whirlpool Corporation will not pay for:

1. Service calls to correct the installation of your refrigerator, to instruct you how to use your refrigerator, to replace house fuses or correct house wiring or plumbing, to replace light bulbs.
  2. Repairs when your refrigerator is used in other than normal, single-family household use.
  3. Pickup and delivery. Your refrigerator is designed to be repaired in the home.
  4. Damage to your refrigerator caused by accident, alteration, misuse, fire, flood, improper installation, acts of God, or use of products not approved by Whirlpool Corporation.
  5. Any food loss due to product failure.
  6. Repairs to parts or systems resulting from unauthorized modifications made to the appliance.
  7. Replacement parts or repair labor costs for units operated outside the United States or Canada.
- 

### WHIRLPOOL CORPORATION SHALL NOT BE LIABLE FOR INCIDENTAL OR CONSEQUENTIAL DAMAGES

Some states do not allow the exclusion or limitation of incidental or consequential damages, so this exclusion or limitation may not apply to you. This warranty gives you specific legal rights, and you may also have other rights which vary from state to state.

**Outside the 50 United States this warranty does not apply. Contact your authorized Whirlpool dealer to determine if another warranty applies.**

If you need service, please consult the "Troubleshooting" section of this book. After checking "Troubleshooting," additional help can be found by checking the "Assistance or Service" section. 7/01

---

**Keep this book and your sales slip together for future reference. You must provide proof of purchase or installation date for in-warranty service.**

Write down the following information about your refrigerator to better help you obtain assistance or service if you ever need it. You will need to know your complete model number and serial number. You can find this information on the model and serial number label, located on your appliance.

Dealer name \_\_\_\_\_  
Address \_\_\_\_\_  
Phone number \_\_\_\_\_  
Model number \_\_\_\_\_  
Serial number \_\_\_\_\_  
Purchase date \_\_\_\_\_