

**Follow
these
easy-step**

**INSTALLATION
INSTRUCTIONS**

 **for your**
Whirlpool
automatic washer

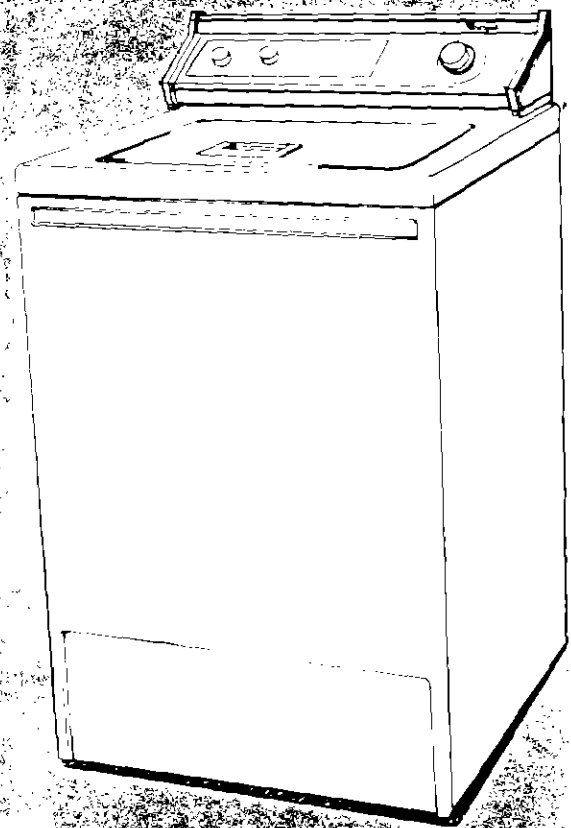

Before you start...

Mark an X across the letter or number as you complete each step.

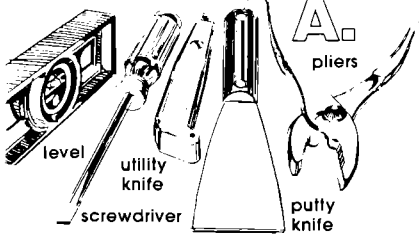

You need these tools to install your Whirlpool washer. Get them all together in one place to keep track of them.

B Untape and open washer lid. Remove parts and literature packages. Close and retape lid.

U-shaped SUDS-MISER[®] hose **L-shaped SUDS-MISER[®] hose**



hairpin SUDS-MISER[®] hose **drain hose extension**

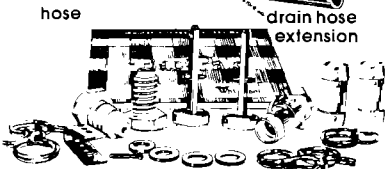

- 1 red hose clamp
- 2 straight hose connectors
- 2 rear leveling legs
- 1 angled hose connector
- 2 front legs
- 2 silver hose clamps
- 4 flat water hose washers
- 2 green hose clamps
- 2 grounding clamp with screw

C Remove all parts from the plastic packages. Line these up next to your tools so each part is there when you need it.

D Hot and cold water faucets Grounded electrical outlet

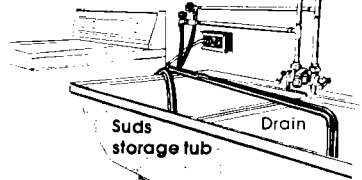

Level floor

Check the spot where you're going to install your washer...proper installation is your responsibility. Make sure you have everything necessary for proper installation. You'll need: **Level floor** (maximum variation allowed 1 inch). **Hot and cold water faucets** within 4 feet of the back of the washer and with enough pressure (5-100 PSI) to give you good washing. Water heater should be set to deliver 140°F water to the washer for best results. **Grounded electrical outlet** required for your personal safety. (See back of instructions.) To drain your Whirlpool washer, you need either a **double 20 gallon laundry tub** or a **tub and two-inch diameter standpipe** having a minimum carry-away capacity of 17 gallons per minute.

(A special standpipe for single tub, Part No. 89121, is available from Whirlpool authorized parts distributors.) The top of the tub or the top of the standpipe cannot be lower than 34 inches or higher than 72 inches from the bottom of the washer. Use a floor drain only if a siphon break (air valve to equalize pressure) is installed. (A siphon break, Part No. 76560, is available from Whirlpool authorized parts distributors.)

Now, start...



1. ...by taping the washer lid closed so it won't be damaged while you're moving the washer.

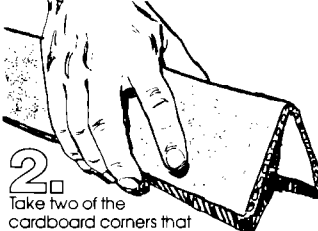

2. Take two of the cardboard corners that fell away from the carton and place them on the floor in back of the washer.

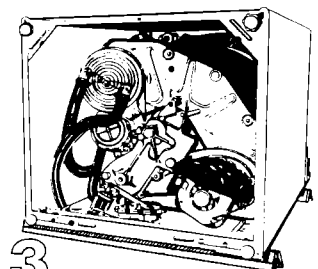

3. Firmly grasp the body of the washer and gently lay it on its back on the cardboard corners.



4. Pick up a rear leveling leg; turn it so the flat side and pegs fit into the hole in the bottom corner. Push the leg in until it snaps into place. Do the same thing with the other leveling leg in the other lower corner.

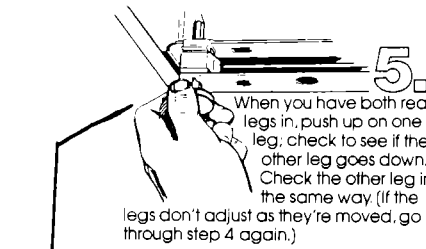

5. When you have both rear legs in, push up on one leg; check to see if the other leg goes down. Check the other leg in the same way. (If the legs don't adjust as they're moved, go through step 4 again.)

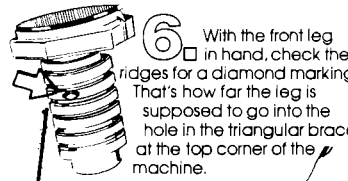

6. With the front leg in hand, check the ridges for a diamond marking. That's how far the leg is supposed to go into the hole in the triangular brace at the top corner of the machine.

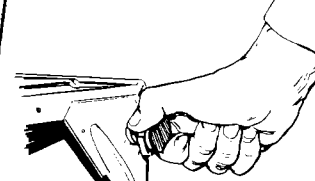

7. Start to screw the front leg into the hole by hand. A little liquid detergent to lubricate the screw will help. (You'll need pliers to turn the leg all the way to the diamond.)

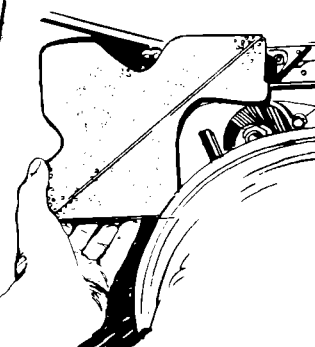

8. As you look at the bottom of the machine, find the white foam piece in the upper left corner. Pull or break this piece out, and place it next to the parts.

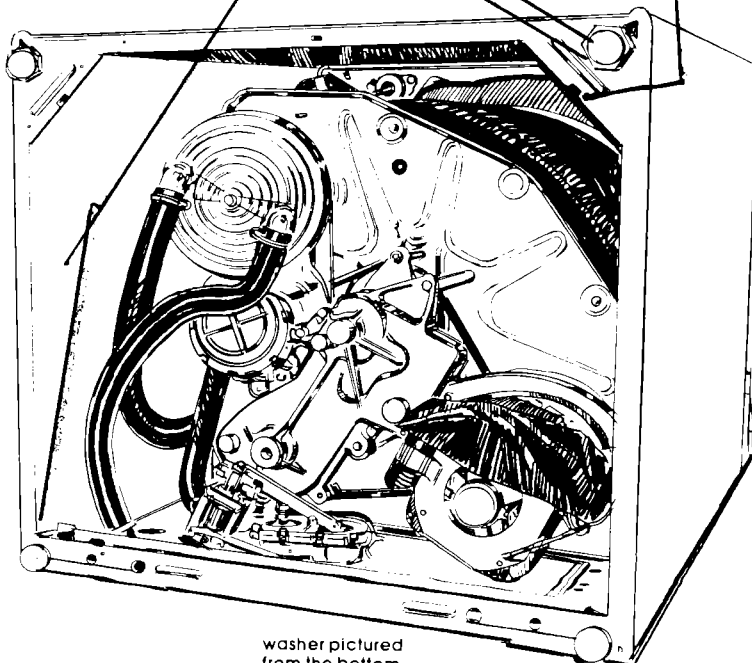

washer pictured from the bottom.

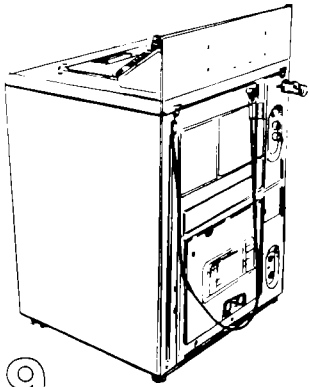

9.
Grasping the body, turn the washer upright.

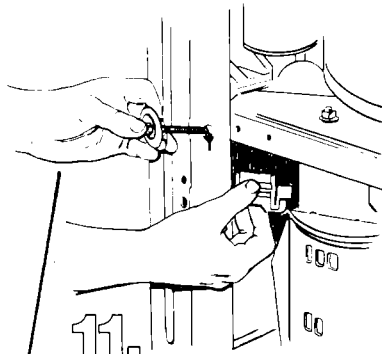

11.
Take out the two shipping bolts on either side of the panel; remove the plastic shipping spools from behind the bolts. Put the bolts and spools aside with the first shipping piece (from step 8).

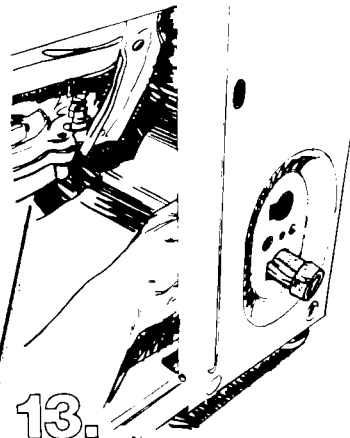

13.
Reach inside the lower right corner of the washer body; grasp the drain hose and connector. Push the connector through the bottom hole.

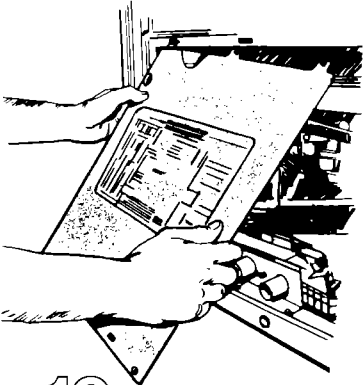

10.
As you look at the back of the washer, remove the brown/gray (service) panel in the lower half portion.

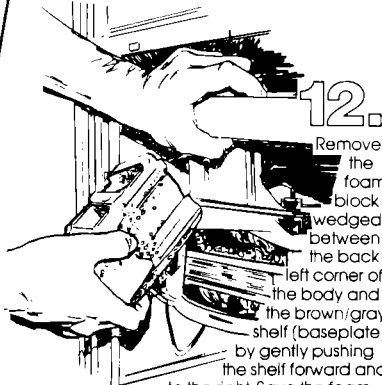

12.
Remove the foam block wedged between the back left corner of the body and the brown/gray shelf (baseplate) by gently pushing the shelf forward and to the right. Save the foam block with the other shipping pieces.

The shelf-like baseplate should move easily after all the shipping pieces have been removed.

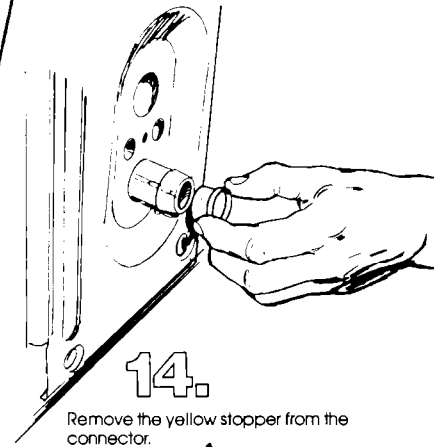

14.
Remove the yellow stopper from the connector.

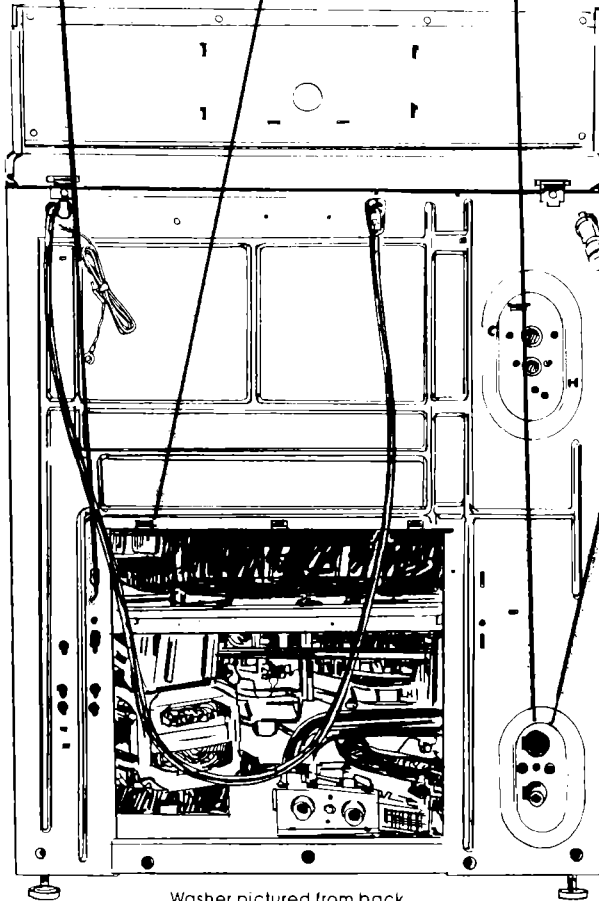

Washer pictured from back.

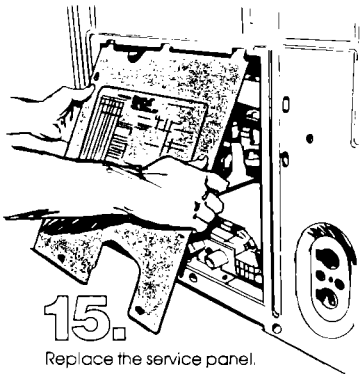

15.

Replace the service panel.

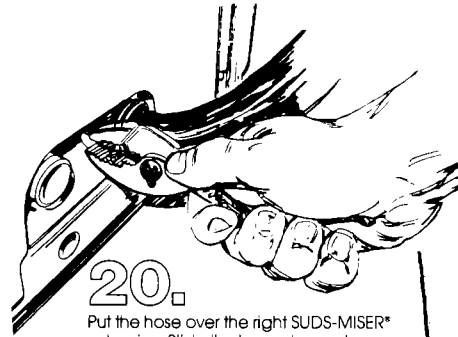

20.

Put the hose over the right SUDS-MISER® extension. Slide the hose clamp down over the hose and extension.



22.

Take the hairpin suds hose that has the strainer in one end of it. Place the strainer end in the laundry tub so that it touches the bottom.

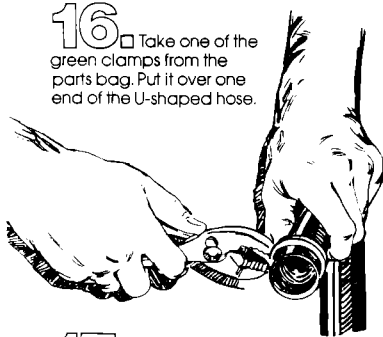

16.

Take one of the green clamps from the parts bag. Put it over one end of the U-shaped hose.

21.

Take the silver hose clamp from the parts bag. Put the clamp over the "hook" end of the L-shaped SUDS-MISER® hose. MAKE SURE THE HOSE IS DIRECTED TOWARDS THE LAUNDRY TUB. Then, push the hose on the left SUDS-MISER® extension; slide the clamp into position covering hose and extension.

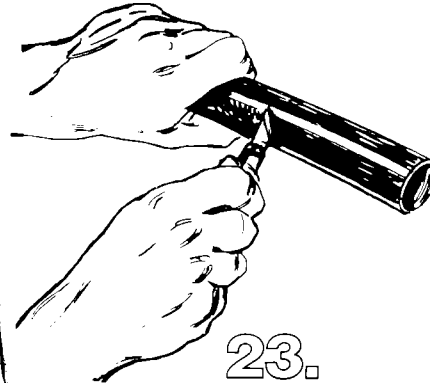

23.

Mark a line where the back of the washer will be when it is in its permanent place. Estimate how long the two suds hoses should be, when joined, and cut to fit.



17.

Put the hose over the plastic connector. Slide the hose clamp down over the hose and connector.

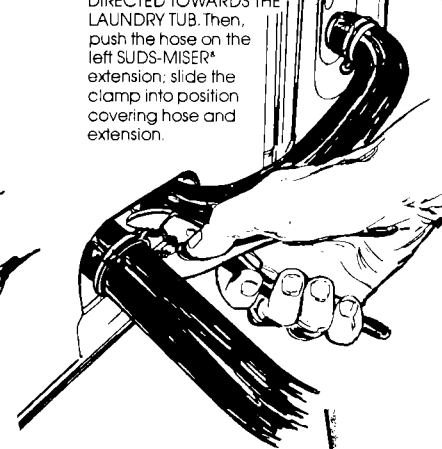

18.

Remove the red stopper from the right SUDS-MISER® extension.

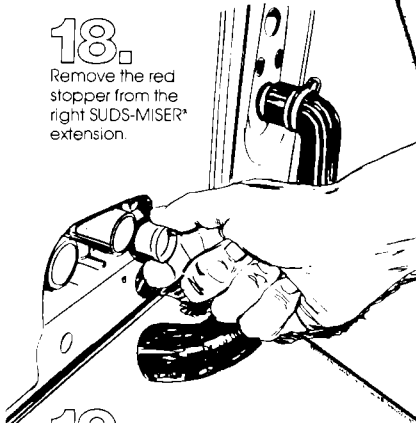

19.

Put the second green clamp over the other end of the U-shaped hose.

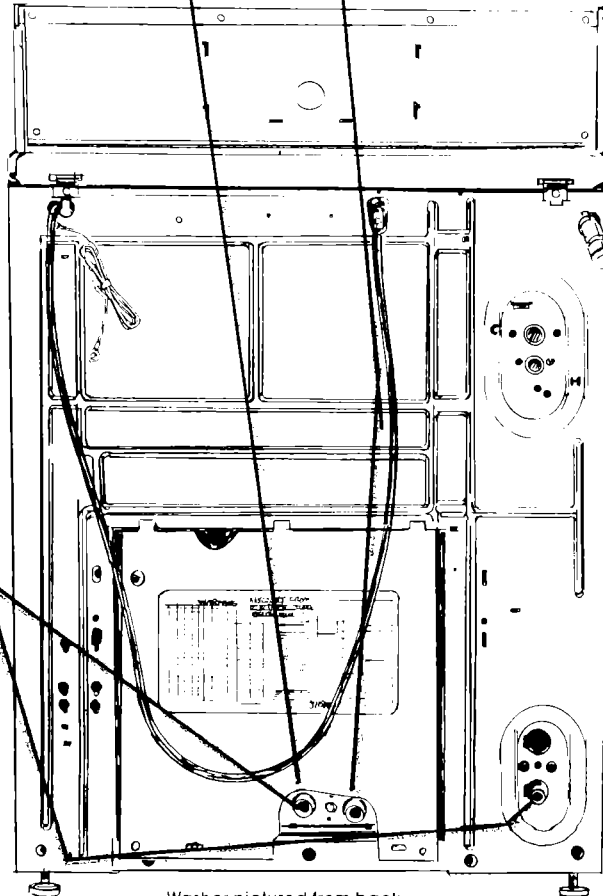
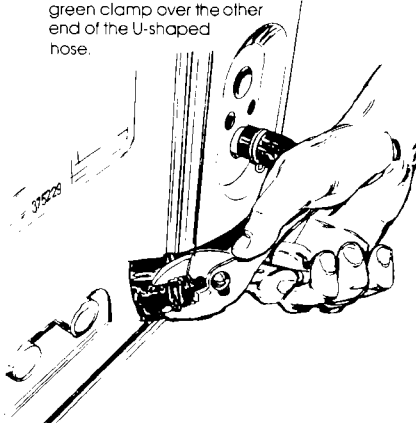

Washer pictured from back



24.

Join the two suds hoses with the straight plastic connector. **MAKE SURE THE HOSES ARE NOT TWISTED OR KINKED.** If the hose is not directed towards the laundry tub, **unclamp it and adjust.**



25.

Before you're ready to attach water supply hoses, run a little water from the faucets. This gets rid of any particles that might clog the hoses.

Use the new hoses and washers that came with your Whirlpool washer.

coupling

washer

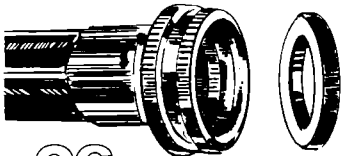

26.

Now place a flat washer into each end of the inlet hoses. (Check to make sure washers are firmly seated in couplings.) Attach hoses to faucets. Tighten couplings by hand, then make a final two-thirds turn with pliers.

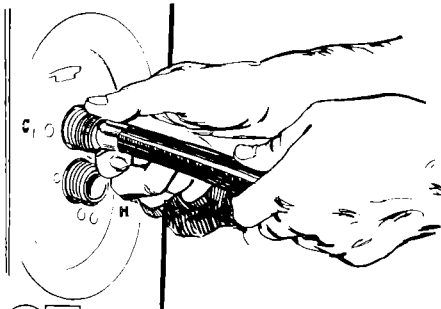

27.

Put the two washers that are left in the opposite ends of the water hoses. Attach the hose from the cold water faucet to the top valve opening (marked "C") on the washer. The hot water hose attaches to the opening (marked "H") underneath. Tighten couplings by hand, then make an additional two-thirds turn with pliers.

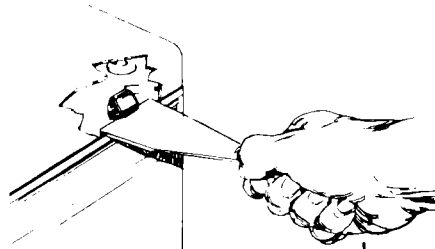

28.

Moving to the front of the washer, doublecheck the tape on the lid to make certain it's secure. Raise the top of the washer by inserting the blade of a putty knife in the slim opening (1/2" down from the top of the washer). Press against latch 2 1/2" in from the side of the washer. Lift the top as you press against the latch.

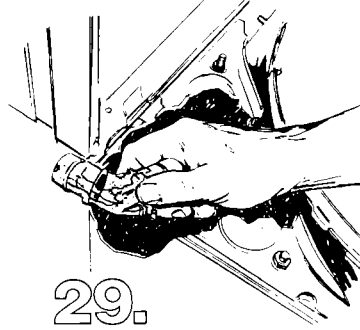

29.

Take the plastic connector from the parts bag. Grasp the tabbed end. Standing in front of the washer, reach inside the upper back left corner of washer body; snap and lock the connector in the hole. Turn the connector in the direction of the standpipe or sink.

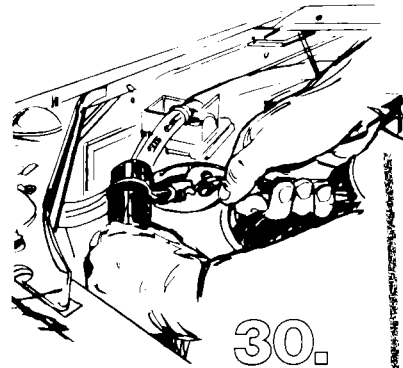

30.

Take the red hose clamp from the parts bag, and put it over the (internal) drain hose located inside that corner.

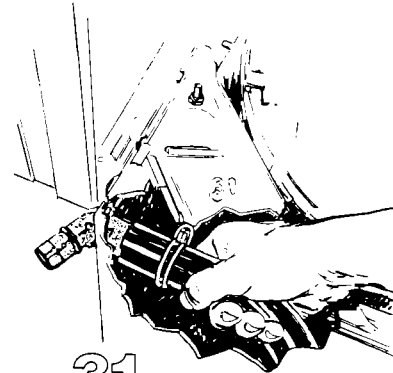

31.

Put the hose over the plastic connector. Slide the hose clamp down over the (internal) drain hose and connector. **MAKE SURE THE HOSE IS NOT TWISTED OR KINKED.**

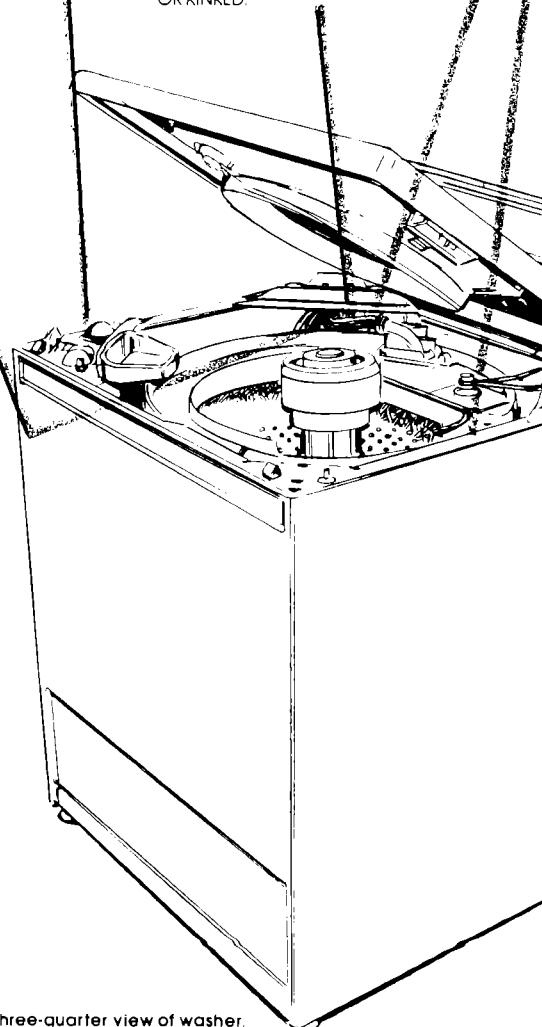

three-quarter view of washer.

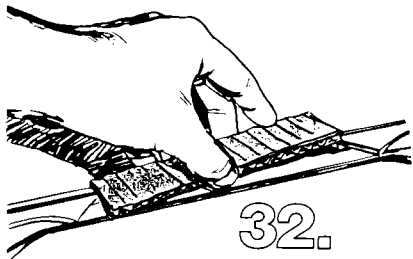

32.

While you are still in front of the washer, take out the chipboard packing pieces and tape from the top right and left sides of the washer body. Close the top of the washer. Remove Consumer Buy Guide from the washer lid.

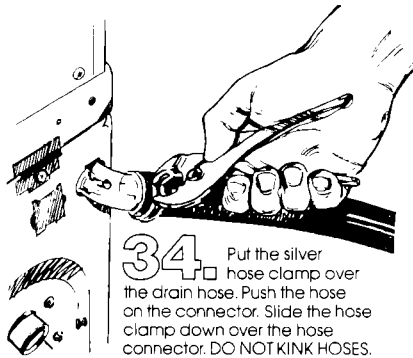

34. Put the silver hose clamp over the drain hose. Push the hose on the connector. Slide the hose clamp down over the hose connector. DO NOT KINK HOSES.

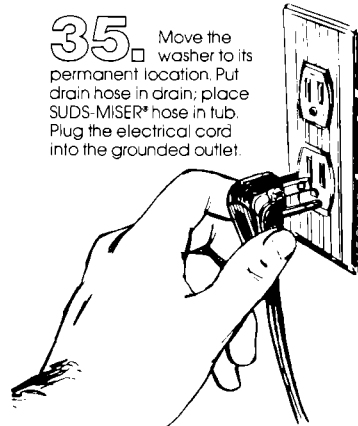

35. Move the washer to its permanent location. Put drain hose in drain; place SUDS-MISER® hose in tub. Plug the electrical cord into the grounded outlet.



33.

Put the "hook" end of the drain hose in the tub drain or standpipe. Estimate how far away the machine will be when it is in its permanent place. Cut the hose to that length. Check to see if the connector is pointed in the right direction for the drain hose. If it is not correct, unclamp the internal hose and adjust the connector.

NOTE: If the drain hose will not reach from the machine to the drain, install the drain hose extension to the machine. Then connect the drain hose to the drain hose extension using the remaining straight hose connector.

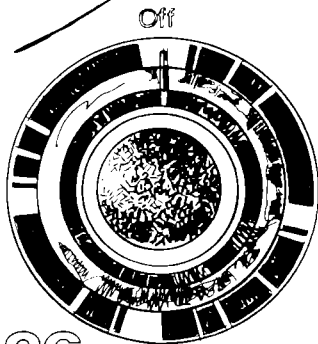

36. With the washer control in the "OFF" position, turn on the water faucets and check for leaks. Tighten couplings if necessary.

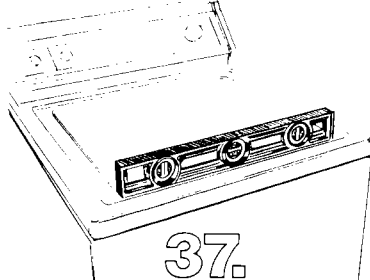
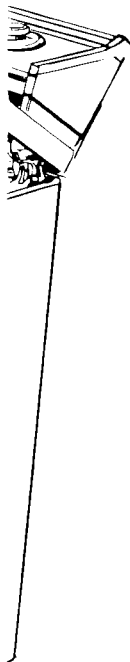

37.

To make sure your new washer is level, take a carpenter's level and place it on the top of the washer, first side to side, then front to back. If you do not have a level, take your Whirlpool Operating instructions; turn to the page where the controls are shown. Following those directions, (remove tape from washer lid) fill the washer basket to any given row of holes, then stop the washer. Check to see if the water meets all the holes all the way around the baskets. If it does not, screw the front feet of the washer up or down to adjust. Then tilt the machine forward and the back legs will self-adjust.

38.

Start the washer again and allow it to complete a cycle. While you have the Operating instructions out, take a few minutes to read it, so your new washer will keep working its best.

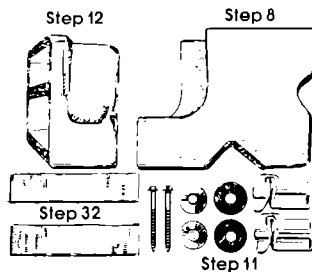

39. Check to see if you have all of these shipping pieces removed from the washer. If you don't remove all the shipping materials, your washer may "walk" away from its location...it's happened!

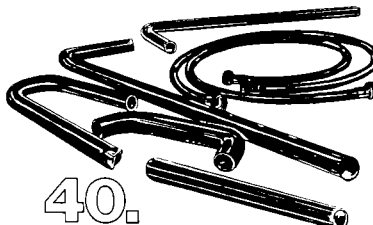

40.

Now check to see that all of the parts you removed from the washer basket in Step B are now installed in the washer. If you are missing a shipping piece or still have an extra part, go back through the steps to see what you skipped.

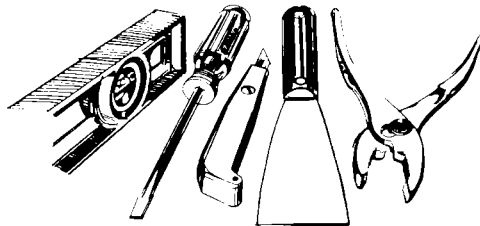

41.

Finally, check to make sure you have all the tools you started with.

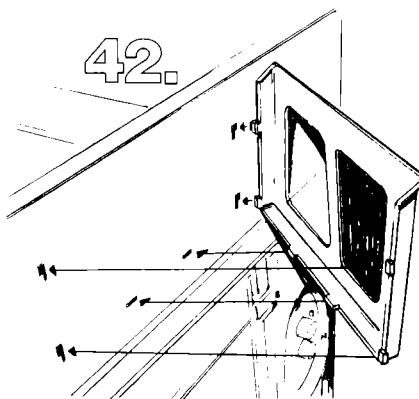

42.

Installing the literature rack. Insert tabs (2 on each side and 2 on the bottom) into the back of the washer console. Gently push in and down until all tabs lock in place.



ELECTRICAL REQUIREMENTS

OBSERVE ALL GOVERNING CODES AND ORDINANCES

RECOMMENDED GROUNDING METHOD.

DO NOT, UNDER ANY CIRCUMSTANCES, REMOVE THE POWER SUPPLY CORD GROUND PRONG.

For your personal safety, this appliance must be grounded. This appliance is equipped with a power supply cord having a 3-prong grounding plug. To minimize possible shock hazard, the cord must be plugged into a mating 3-prong grounding type wall receptacle, grounded in accordance with the National Electrical Code and local codes and ordinances. If a mating wall receptacle is not available, it is the personal responsibility and obligation of the customer to have properly grounded 3-prong wall receptacle installed by a qualified electrician. See Figure 1.

For added personal safety, using the clamp and green colored copper wire furnished, connect this separate ground wire (#18 minimum) from the external ground connector on the back of the appliance to a grounded cold water pipe.* See Figure 2.

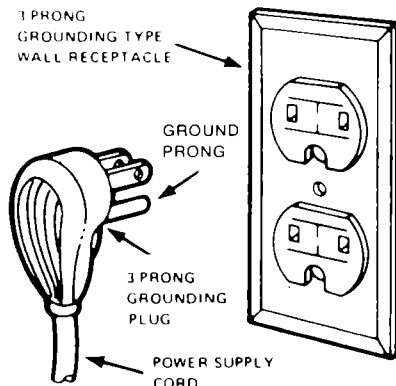

FIGURE 1

ELECTRICAL GROUND IS REQUIRED ON THIS APPLIANCE. A 120 Volt, 60 Hz, AC only 15 Ampere fused electrical supply is required. (Time delay fuse or circuit breaker is recommended.) It is recommended that a separate circuit serving only this appliance be provided. **DO NOT** use an extension cord.

ALTERNATE GROUNDING METHOD

DO NOT, UNDER ANY CIRCUMSTANCES, REMOVE THE POWER SUPPLY CORD GROUND PRONG.

If changing and properly grounding the wall receptacle is impossible and where local codes permit (consult your electrical inspector), a temporary adapter may be plugged into the existing 2-prong wall receptacle to mate with the 3-prong power supply cord. **THIS, HOWEVER, IS NOT RECOMMENDED.**

If this is done, you **must** connect a separate copper ground wire (No. 18 minimum) to a grounded cold water pipe* by means of a clamp and then to the external ground connector screw. See Figure 2. **Do not ground to a gas supply pipe.** Do not connect to electrical supply until appliance is permanently grounded.

*Grounded cold water pipe must have metal continuity to electrical ground and not be interrupted by plastic, rubber or other electrically insulating connectors (including water meter or pump) without adding a jumper wire at these connections.

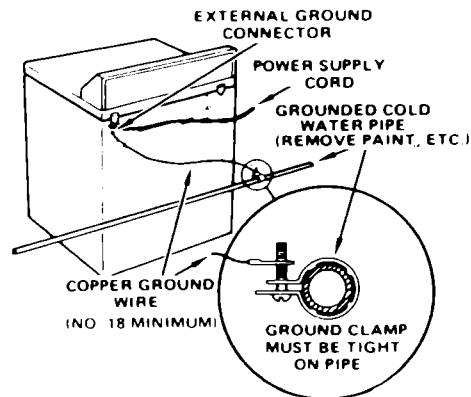

FIGURE 2

RECESSED AREA INSTRUCTIONS

This machine may be installed in a recess or closet.

The following installation spacings and door opening areas for this washer are possible when installed as noted.

(Spacing as noted is in inches and is minimum allowable. For ease of installation and service, additional spacing should be considered.)

Dimensions F, G, and H required when door is installed. (Louvered door with air openings in top & bottom is acceptable.)

NOTE: Companion appliance spacings should be considered.

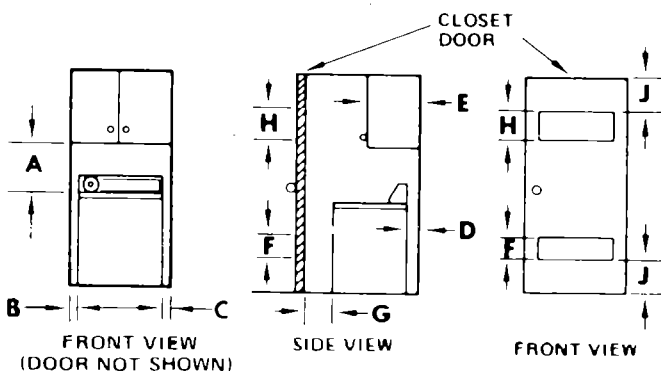

RECESS INSTALLATION	A	B	C	D	E
	15	0	0	4	14 MAX

CLOSET INSTALLATION	A	B	C	D	E	F	G	H	J
	15	0	0	4	14 MAX	24 SQ. IN	1" MIN	48 SQ. IN	3

MINIMUM INSTALLATION SPACING

L. C. SCF Suds