



# Indoor and Outdoor Tankless Water Heaters

**Safety Information** .....2, 3

**Operating Instructions**

Care and Cleaning .....7-8  
Control Features .....4  
Error Codes .....9  
Flushing the Heat Exchanger .....11  
Setting Priority  
for Multiple Controllers .....6  
Setting the Temperature .....6  
Specifications .....12  
Technical Data .....14  
To Set the Water Heater .....5  
To Turn Off Gas to  
the Water Heater .....5  
Water Quality .....10

**Troubleshooting Tips** .....13

**Consumer Support**

Consumer Support .....Back Cover  
Warranty .....15

**Owner's Manual**

GN75DNSRSA  
GN94DNSRSA  
GP94DNSRSA  
GN75ENSRSA  
GN94ENSRSA  
GP94ENSRSA

**Write the model and serial numbers here:**

**Model #** \_\_\_\_\_

**Serial #** \_\_\_\_\_

You can find them on the left side or the bottom of your water heater.

# IMPORTANT SAFETY INFORMATION. READ ALL INSTRUCTIONS BEFORE USING.

**INSTALLER:** Leave this manual with the appliance.

**CONSUMER:** Retain this manual for future reference.

**⚠ WARNING:** If the information in this manual is not followed exactly, a fire or explosion may result causing property damage, personal injury or death.

- Do not store or use gasoline or other flammable vapors and liquids in the vicinity of this or any other appliance.

## – WHAT TO DO IF YOU SMELL GAS

- 1 Do not try to light a match, or cigarette, or turn on any gas or electrical appliance.
  - 2 Do not touch any electrical switch; do not use any phone in your building.
  - 3 Clear the room, building or area of all occupants.
  - 4 Immediately call your gas supplier from a neighbor's phone. Follow the gas supplier's instructions carefully.
  - 5 If you cannot reach your gas supplier, call the fire department.
- Installation and service must be performed by a qualified installer, service agency or the gas supplier.

**⚠ WARNING!** For your safety, the information in this manual must be followed to minimize the risk of fire or explosion, electric shock, or to prevent property damage, personal injury or loss of life.



ANSI Z21.10.3 • CSA 4.3



## SAFETY BEHAVIORS AND PRACTICES

### **⚠ WARNING!**

- Keep the area around the appliance clear and free from combustible materials, gasoline and other flammable vapors and liquids.

**COMBUSTIBLE MATERIAL:** As pertaining to materials adjacent to or in contact with heat-producing appliances, vent connectors, gas vents, chimneys, steam and hot water pipes and warm air ducts, shall mean materials made of or surfaced with wood, compressed paper, plant fibers or other materials that are capable of being ignited and burned. Such material shall be considered combustible even though flame-proofed, fire-retardant treated or plastered.

- Do not use this appliance if any part has been under water. Immediately call a qualified service technician to inspect the appliance and to replace any part of the control system and any gas control which has been under water.
- Indoor models are equipped with a three-prong plug for your protection against shock hazard and should be plugged directly into a properly grounded three-prong receptacle. Do not cut or remove the ground prong from this plug.
- Outdoor models must be hardwired to meet local codes.
- Any alteration to the appliance or its controls can be dangerous and will void the warranty.
- Always check the water temperature before entering a shower or bath.
- This appliance does not have a pilot. It is equipped with an ignition device which automatically lights the burner. Do **not** try to light the burner by hand.

- **BEFORE OPERATING**, smell all around the appliance area for gas. Be sure to smell next to the floor because some gas is heavier than air and will settle on the floor.

- Use only your hand to push in or turn the gas control knob. Never use tools. If the knob will not push in or turn by hand, do not try to repair it; call a qualified service technician. Force or attempted repair may result in a fire or explosion.

- Properly ground the water heater to conform with all governing codes and ordinances. Follow details in the Installation Instructions.

- This appliance must be vented per Installation Instructions.

**⚠ WARNING:** This unit is not intended or qualified for use in manufactured homes, mobile homes or recreational vehicles.

**CAUTION: BURN HAZARD.** Hot exhaust and vent may cause serious burns. Keep back from water heater unit. Keep small children and animals away from unit.

**CAUTION:** Hot Water outlet pipes leaving unit can be hot to touch. Insulation must be used for hot water pipes below 36" due to burn risk to children.



**READ AND FOLLOW THIS SAFETY INFORMATION CAREFULLY.  
SAVE THESE INSTRUCTIONS**

## Operating instructions.

This water heater is one of the most advanced water heaters available. It provides a continuous supply of hot water at a preset temperature. This appliance is direct vent, where air is brought in from the outside and combustion gases are exhausted to the outside.

While electricity, water and gas supplies are connected, this water heater produces hot water whenever a hot water tap is open.

Ignition is electronic. There is no pilot light consuming gas while the water heater is not being used. The gas burner lights automatically when the hot water tap is opened and goes out when the tap is closed.

The temperature of the outgoing hot water is constantly monitored. The water heater may adjust the water flow in order to maintain the temperature setting. The water flow may vary from summer to winter due to the difference in ground water temperature.

**NOTE:** We do not recommend installing a remote control outdoors.

**For outdoor unit only,** installation of the indoor remote control is highly recommended. The remote control can set the temperature within a specific range and can provide error codes to diagnose any problems.

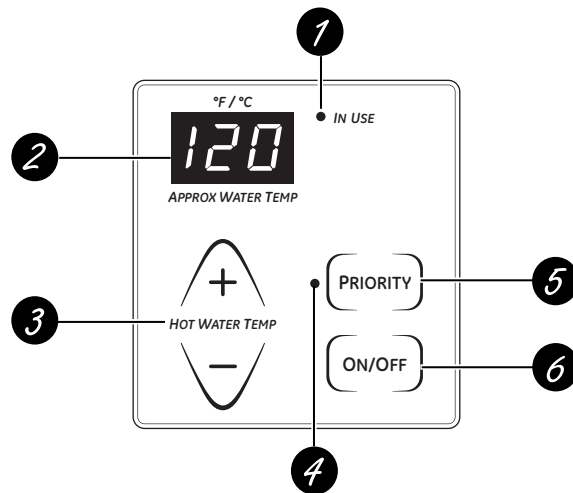

### Control Features

**NOTE:** Indoor models have an integrated control with optional remote controls. Outdoor models have a remote control intended to be mounted indoors.

- 1 **In-Use Indicator**  
Indicates that hot water is being supplied (i.e. a hot water tap is open).
- 2 **Temperature Display**  
Shows the temperature setting. When a fault is detected, a two-digit error code flashes on this display.
- 3 **Thermostat Adjustment**  
Increases or decreases the temperature setting.
- 4 **Priority Indicator**  
When lit, indicates that the control is setting the temperature. (Always ON when only one control is connected.)
- 5 **Priority Button**  
When using an optional remote control(s), the priority can be switched to another control by pressing its **Priority** Button when no hot water is running. This feature is available with multiple remote controls.
- 6 **ON/OFF Button**  
Used to turn the water heater ON or OFF.



## FOR YOUR SAFETY, READ BEFORE OPERATING

**⚠ WARNING:** If you do not follow these instructions exactly, a fire or explosion may result, causing property damage, personal injury or loss of life.

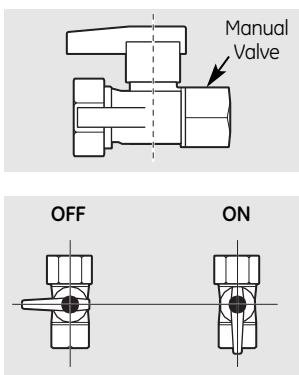
- A.** This appliance does not have a pilot. It is equipped with an ignition device which automatically lights the burner. Do not try to light the burner by hand.
- B.** BEFORE OPERATING, smell all around the appliance area for gas. Be sure to smell next to the floor because some gas is heavier than air and will settle on the floor.
- WHAT TO DO IF YOU SMELL GAS
- Do not try to light any appliance.
  - Do not touch any electrical switch; do not use any phone in your building.
  - Immediately call your gas supplier from a neighbor's phone. Follow the gas supplier's instructions.
  - If you cannot reach your gas supplier, call the fire department.
- C.** Use only your hand to push in or turn the gas control knob. Never use tools. If the knob will not push in or turn by hand, do not try to repair it; call a qualified service technician. Force or attempted repair may result in a fire or explosion.
- D.** DO NOT use this appliance if any part has been under water. Immediately call a qualified service technician to inspect the appliance and to replace any part of the control system and any gas control which has been under water.



### Operating Instructions

- 1 STOP!** Read the safety information above.
- Set the thermostat to the lowest setting.
- Turn off all electrical power to the appliance using the **ON/OFF** button.
- This appliance is equipped with an ignition device which automatically lights the burner. Do not try to light the burner by hand.
- Locate the manual gas valve on the side of the water heater. Turn the manual valve clockwise to the full OFF position .
- Wait five (5) minutes to clear out any gas. Then smell for gas, including near the floor. If you smell gas, STOP! and follow "B" in the safety information above. If you do not smell gas, go to the next step.
- Turn the manual gas valve counterclockwise to the full ON position .
- Turn on all electrical power to the appliance using the **ON/OFF** button.
- Set the thermostat to the desired setting.
- Open a hot water tap. If the appliance will not operate, follow the instructions "To Turn Off Gas to Appliance" and call your service technician or gas supplier. See the Installation Instructions for additional information.

### To Turn Off Gas to Appliance

- Turn off all electrical power to the appliance using the **ON/OFF** button.
- Set the thermostat to the lowest setting.
- Locate the manual gas valve on the side of the water heater. Turn the manual valve clockwise to the full OFF position .

## Setting the temperature.



Hot water can be dangerous, especially for infants or children, the elderly or infirm. There is a potential for scalding by hot water if the thermostat is set too high.

Water temperatures over 125°F (51°C) can cause severe burns or scalding, resulting in death.

Hot water can cause first-degree burns with exposure for as little as:

3 seconds at 140°F (60°C)

20 seconds at 130°F (54°C)

8 minutes at 120°F (48°C)

Test the temperature of the water before placing a child in the bath or shower.

Do not leave a child or an infirm person in the bath unsupervised.

### Temperature Ranges

Suggested temperatures are:

- Kitchen: 120°F (49°C)
- Shower: 98°–110°F (37°–43°C)

These temperatures are suggestions only.

Temperatures lower than 98°F (37°C) can be obtained at the tap by mixing with cold water.

This water heater will attempt to provide hot water at the set temperature even when the water flow is varied or when more than 1 tap is in use. The water heater can deliver water at only one temperature setting at a time. The available temperatures for a given model are provided below.

	AVAILABLE TEMPERATURE SETTINGS												
Temp in Fahrenheit (°F)	98	100	102	104	106	108	110	115	120	125	130	135	140
Temp in Celsius (°C)	37	38	39	40	41	42	43	46	49	52	54	57	60

**NOTE:** The unit can display Celsius or Fahrenheit. Celsius ranges from 37° to 60° and Fahrenheit ranges from 97° to 140°.

**To change the temperature scale from Celsius to Fahrenheit or vice versa, turn off the unit, then press and hold the ON/OFF button for 5 seconds.**

**NOTE:** Very small flows (a trickle) will not turn on the water heater. If you do not turn the hot faucet on enough, the water will not be hot. A typical sink faucet that is fully opened is 1.2 GPM—a faucet must be flowing approximately 0.6 GPM to produce hot water.

### Setting Control to Mute

To eliminate the beeps when keys are pressed or to turn the beeps back on, press and hold both the + and – buttons until a beep is heard (approximately 5 seconds).

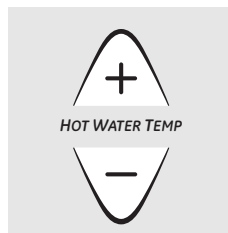

### Setting PRIORITY for Multiple Controllers

**NOTE:** If you have one remote, the priority light is always green.

**1** Press the **Priority** button on the control. The green priority light will glow, indicating that this control is controlling the temperature and that the water heater is ready to supply hot water.

The priority can only be changed while no hot water is running.

**2** Press the + or – buttons to obtain the desired temperature setting.

The water heater provides water at this temperature setting until it is changed again with this or another remote control.

#### NOTES:

- While any hot water is being provided (in-use light is green), the temperature setting can only be adjusted between 98°F and 110°F. If the temperature is over 110°F, no adjustment can be made.
- If a newly installed unit has not been powered for at least 6 hours, the temperature will return to the default setting of 104°F (40°C) if power is interrupted.
- There may be a variation between the temperature displayed on the remote control and the temperature at the tap due to weather conditions or the length of pipe to the water heater.

## **⚠ WARNING:**

Turn off the electrical power supply or unplug the unit, and turn off the manual gas valve and the manual water control valve whenever servicing or cleaning the unit.

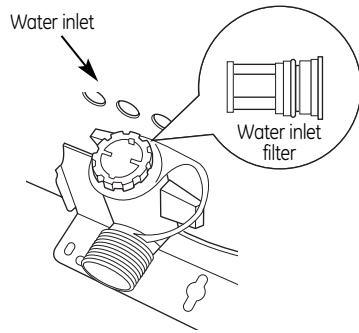

**NOTE:** View shown is from under the unit.

Repairs should be performed by a qualified service technician. The appliance should be inspected annually by a qualified service technician. Verify proper operation after servicing.

### **Cleaning the Inlet Filter**

It is imperative that control compartments, burners and circulating air passageways of the appliance be kept clean.

**CAUTION:** Before performing this action, first remove power to the water heater and be sure to not stand near the discharge line of the pressure relief valve. This will prevent a possible scald injury.

- 1 Turn off and disconnect electrical power. Allow water heater to cool.
- 2 Shut off water inlet.
- 3 Open hot water tap at nearest faucet.
- 4 Close outlet valve on unit.
- 5 Have a small pan or bucket ready to catch spilled water.
- 6 Remove and clean the water inlet filter with a small brush. If scale is present, clean in a white vinegar solution.
- 7 Replace water inlet filter.
- 8 Remove the front panel by removing 4 screws.
- 9 Use pressurized air to remove dust from the main burner, heat exchanger and fan blades. Do not use a wet cloth or spray cleaners on the burner. Do not use volatile substances such as benzene and thinners. They may ignite or fade the paint.
- 10 Use soft dry cloth to wipe cabinet.
- 11 Open water valves.
- 12 Check for leaks.
- 13 Connect electrical power and turn on the unit.

### **Vent System**

The vent system should be inspected at least annually for blockages or damage. See vent manufacturer-recommended maintenance and inspection requirements.

More frequent cleaning may be necessary if the installation is in an area subject to high levels of airborne dust, sand, etc. (such as a desert or near sand dunes, etc.) or in an area with high levels of lint or seed pods (such as cottonwoods).

**INDOOR:** Inspect inside joints, condensate collector, outside intake and exhaust.

**NOTE:** It is recommended that inlet air screen be inspected. See Installation Instructions for details.

### **Motors**

Motors are permanently lubricated and do not need periodic lubrication. Keep fan and motor free of dust and dirt by cleaning annually.

### **Remote Control**

Use a soft damp cloth to clean the remote control. Do not use solvents.

## Care and cleaning of the water heater.

### Lime/Scale Buildup

**⚠ WARNING:** Before performing this action, first remove power to the water heater in order to prevent an accidental scald injury.

If you are in a hard water area or do not have a water softener, the system should

be flushed annually or as necessary for lime scale buildup. See page 11.

If you receive Error Code "LC," refer to the procedure *Flushing the Heat Exchanger*. Refer to the section on *Water Quality* to see if your water needs to be treated or conditioned.

### Snow Accumulation

Keep the area around the air intake and flue terminal free of snow and ice. The appliance will not function properly if the intake air or exhaust is impeded (blocked or partially blocked) by obstructions.

#### SATISFACTORY

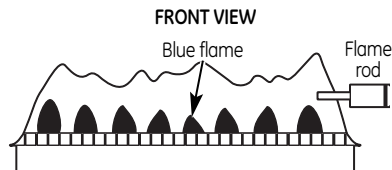

### Visual Inspection of Flame

The burner must flame evenly over the entire surface when operating correctly. The flame must burn with a clear, blue, stable flame. See the parts breakdown of the burner for location of the view ports.

#### UNSATISFACTORY

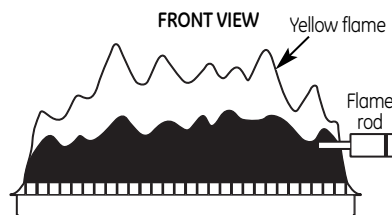

The flame pattern should be as shown in the figures to the left.

**CAUTION:** A qualified service technician should be used to perform this check. A sight glass is located on the burner manifold after the front cover is removed.

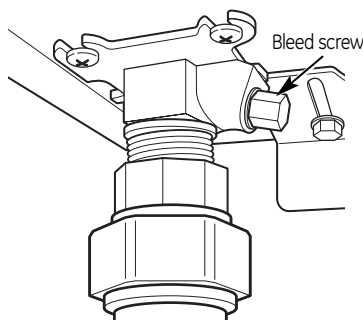

### Winterizing Unit

For cabins, lake homes or any installation where the unit may be unattended for long periods of time, the freeze protection built into the unit will prevent the system from freezing down to  $-30^{\circ}\text{F}$  if electric power and gas are available. However, if the unit is to be left unattended for long periods of time in winter months, it is recommended to unplug and drain the unit. This will prevent damage to the unit from freezing weather and loss of power or gas.

**The system can be drained by the following steps:**

- 1 Turn off and disconnect electrical power. Allow water heater to cool.
- 2 Shut off water inlet.
- 3 Open hot water tap at nearest faucet to relieve system pressure.
- 4 Close outlet valve on unit.

- 5 Have a small pan or bucket ready to catch spilled water.
- 6 Remove the water inlet filter and outlet bleed screw.
- 7 Allow the water to completely drain from the system. Replace the inlet filter and bleed screw.

**To start the system:**

- 1 Open the inlet water valve and check for leaks.
- 2 Open the outlet water valve.
- 3 Plug in or turn on power to the unit.
- 4 Open the faucet and check for proper operation.

When reinstalling the hot water bleed screw, fully secure it with a wrench.



This water heater has the ability to check its own operation continuously. If a fault occurs, an error code will flash on the display of the remote control only when the water is running. This assists with diagnosing the fault, and may enable you to overcome a problem without a service call. Please identify the code displayed when inquiring about service.

**⚠ WARNING:** Some of the checks below may need to be done by a qualified service technician.

## Error Code Table

ERROR	Fault	Remedy
02	No burner operation during freeze protection mode	<ul style="list-style-type: none"> <li>• Check that the gas is turned on at the water heater, gas meter or cylinder. If the system is propane, make sure gas is in the tank.</li> <li>• Call for service.</li> </ul>
10	Air supply or exhaust blockage	<ul style="list-style-type: none"> <li>• Ensure GE-approved venting materials are being used.</li> <li>• Check that nothing is blocking the flue inlet or exhaust.</li> <li>• Check all vent components for proper connections.</li> </ul>
11	No ignition	<ul style="list-style-type: none"> <li>• Check that the gas is turned on at the water heater, gas meter or cylinder. If the system is propane, make sure gas is in the tank.</li> <li>• Ensure appliance is properly grounded.</li> </ul>
12	Flame failure	<ul style="list-style-type: none"> <li>• Check that the gas is turned on at the water heater, gas meter or cylinder. Check for obstructions in the flue outlet. If the system is propane, make sure gas is in the tank.</li> <li>• Ensure appliance is properly grounded.</li> </ul>
14	Thermal fuse	<ul style="list-style-type: none"> <li>• Call for service.</li> </ul>
16	Over temperature warning	<ul style="list-style-type: none"> <li>• Check for restrictions in air flow around unit and vent outlet.</li> <li>• Check for foreign materials in exhaust piping.</li> </ul>
32-72		<ul style="list-style-type: none"> <li>• Call for service.</li> </ul>
LC (00)	Scale buildup in heat exchanger	<ul style="list-style-type: none"> <li>• See page 11 for Flushing Procedures.</li> </ul>
No code	Nothing happens when water flow is activated	<ul style="list-style-type: none"> <li>• Clean inlet water supply filter.</li> <li>• On new installations, ensure hot and cold water lines are not reversed.</li> <li>• Ensure you have at least the minimum flow rate required to fire the unit.</li> </ul>

## Water quality.

Care for your water heater should include evaluation of water quality. If the water exceeds the target levels provided in the table, you should treat or condition the water.

If you are in a hard water area, it is recommended to install a GE water softener prior to the water heater.

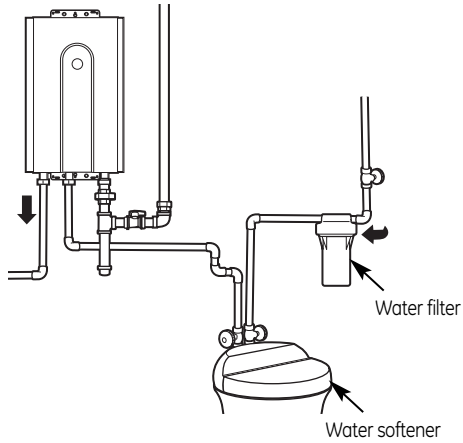

	MAXIMUM LEVEL
Total Hardness	Up to 200 mg/L (12 grains)
Aluminum*	Up to 0.2 mg/L
Chlorides*	Up to 250 mg/L
Copper*	Up to 1.0 mg/L
Iron*	Up to 0.3 mg/L
Manganese*	Up to 0.05 mg/L
pH*	6.5 to 8.5
TDS (Total Dissolved Solids)*	Up to 500 mg/L
Zinc*	Up to 5 mg/L

\* Source: Part 143 National Secondary Drinking Water Regulations

# Flushing the heat exchanger (error code LC or 00).

**⚠ WARNING:** Before performing this action, first remove power to the water heater in order to prevent an accidental scald injury.

**NOTE:** GE recommends that this task be performed by a trained service provider.

An "LC" or "00" error code indicates the unit is beginning to have water hardness coat the heat exchanger and must be flushed. Failure to flush the appliance will cause damage to the heat exchanger. Damage caused by water hardness is not covered by the unit's warranty. After flushing, reset the LC fault code by turning off the power to the unit and turning the power back on.

- 1 Disconnect electrical power to the water heater.
- 2 Close the shut-off valves on both the hot water and cold water lines (V3 and V4).
- 3 Connect pump outlet hose (H1) to the cold water line at service valve V2.
- 4 Connect drain hose (H3) to service valve V1.
- 5 Pour approximately 4 gallons of virgin, food-grade white vinegar or citric acid into pail.
- 6 Place the drain hose (H3) and the hose (H2) to the pump inlet into the cleaning solution.
- 7 Open both service valves (V1 and V2) on the hot water and cold water lines.
- 8 Operate the pump and allow the cleaning solution to circulate through the water heater for 45 minutes.
- 9 Turn off the pump.
- 10 Rinse the cleaning solution from the water heater by:
  - a. removing the free end of the drain hose (H3) from the pail,
  - b. closing service valve V2 and opening shut-off valve V4 (do not open shut-off valve V3),
  - c. allowing water to flow through the water heater for 5 minutes,
  - d. closing service valve V1 and opening shut-off valve V3.
- 11 Disconnect all hoses.
- 12 Remove the in-line filter at the cold water inlet and clean out any residue. Place the filter back into the unit. See page 7.
- 13 Restore electrical power to the water heater.

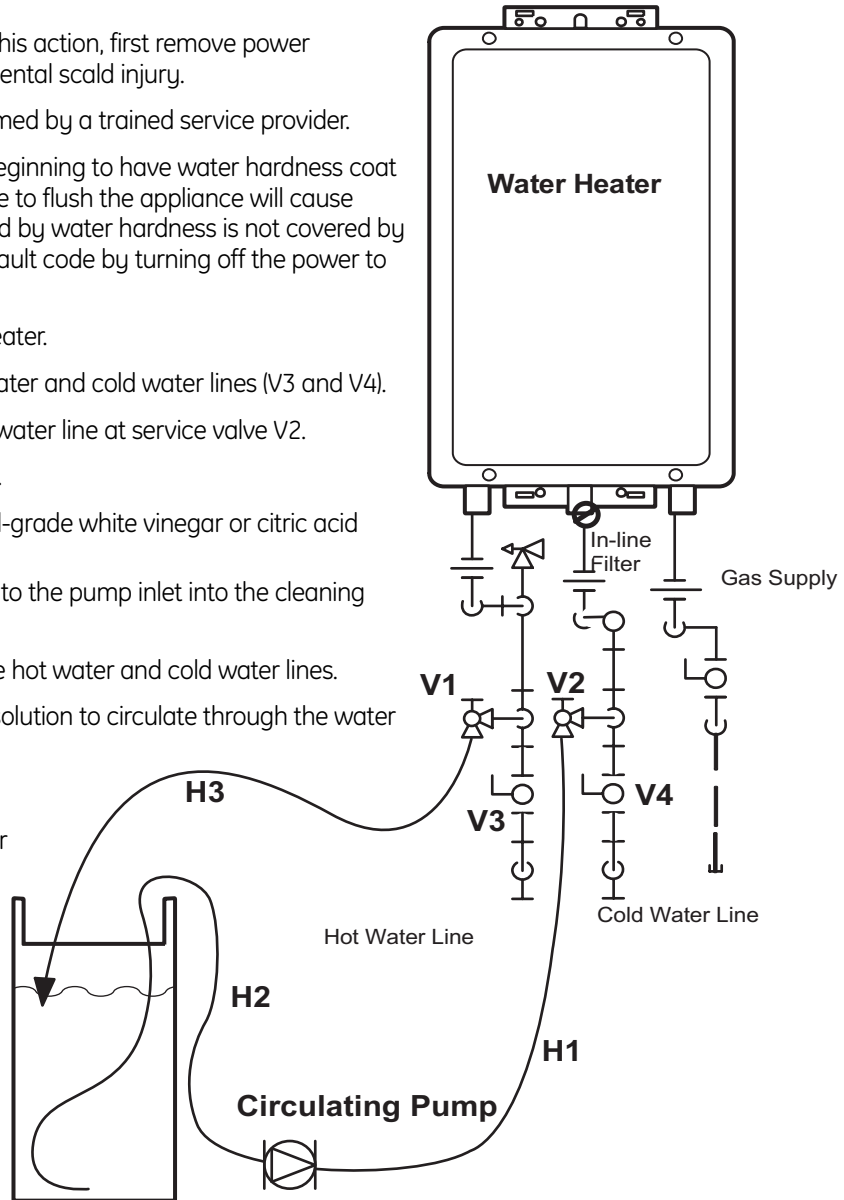

5-gallon pail of virgin, food-grade white vinegar (or virgin, food-grade citric acid)

### KEY

	3/4" Ball Valve		Pressure Regulator
	3/4" Union		Circulating Pump
	Check Valve		Boiler Drain Valve
	Pressure Relief Valve		Solenoid Valve

# Specifications.

Safety Instructions

Operating Instructions

Troubleshooting Tips

Consumer Support

Model		GN75	GN94 and GP94
Minimum Gas Consumption Btu/h		15,000	
Maximum Gas Consumption Btu/h		180,000	199,000 (NG)/190,000 (LP)
Hot water capacity (Min.-Max.)*		0.6–7.5 GPM (2.3–28.5 L/min)	0.6–9.4 GPM (2.3–35.5 L/min)
Hot water capacity (35°F rise)		7.5 GPM (28.5 L/min)	9.4 GPM (35.5 L/min)
Default Temperature Setting (no control)		120°F (49°C)	
Remote Control Default Temperature Setting		104°F (40°C)	
Maximum Temperature Setting		140°F (60°C)	
Minimum Temperature Setting		98°F (37°C)	
Weight		Approximately 49 lbs (22 kg) Indoor Units, 46 lbs (21 kg) Outdoor Units	
Noise Level		55dB (A)	
Electrical Consumption	Normal	79 W	
	Standby	2.8 W	
	Anti-Frost Protection	100 W	
Minimum Gas Supply Pressure	Natural Gas	5" WC	
	Propane	8" WC	
Maximum Gas Supply Pressure	Natural Gas	10.5" WC	
	Propane	13.5" WC	
Approved Gas Type		Natural Gas or Propane – Ensure unit matches gas type it is being installed on.	
Connections		Gas Supply: 3/4" MNPT, Cold Water Inlet: 3/4" MNPT, Hot Water Outlet: 3/4" MNPT	
Ignition System		Direct Electronic Ignition	
Electrical Connections		AC 120 Volts, 60 Hz.	
Water Supply Pressure		Minimum Water Pressure: 20 PSI (Recommended 30–80 PSI for maximum performance; full flow cannot be achieved with 20 psi inlet pressure)	
Maximum Water Supply Pressure		150 PSI	
Remote Control		Non-Polarized Two-Core Cable (Minimum 22 AWG) Remote Control: DC 12 Volts (Digital)	

\* Minimum and maximum water flow may vary slightly, depending on the temperature setting and the inlet water temperature.

The maximum inlet gas pressure must not exceed the value specified by the manufacturer. The minimum value listed is for the purpose of input adjustment.

# Before you call for service...



**Troubleshooting Tips**  
 Save time and money! Review the chart below first and you may not need to call for service.

PERFORMANCE	Possible Causes	What To Do
<i>There is no hot water when tap is opened</i>	There is no gas, water or electricity flowing to unit.	<ul style="list-style-type: none"> <li>• Make sure gas, water and power are turned on.</li> </ul>
	The system requires approximately 0.6 gpm minimum flow to activate the heater.	<ul style="list-style-type: none"> <li>• Ensure faucet aerators are clean and faucet flows at least 0.6 gpm of hot water.</li> <li>• During summer months, increase the temperature setting at the control or increase the water flow.</li> </ul>
<i>Water gets cold when hot water is being used</i>	If the flow from the tap was adjusted to lessen it, the flow may have gone below the minimum required.	<ul style="list-style-type: none"> <li>• During summer months, increase the temperature setting at the control or increase the water flow.</li> <li>• Water flow might be increased by cleaning the aerators on the faucets.</li> </ul>
<i>White smoke comes out of the exhaust</i>	During colder weather, when the exhaust temperature is much hotter than the outside air, the exhaust fumes condense, producing water vapor.	
<i>When a hot tap is opened, hot water does not come out immediately</i>	Hot water must travel through the plumbing from the water heater to the faucet. The time period for hot water to reach the fixture is determined by the amount of water in the plumbing system between the water heater and the fixture, water pressure and the flow rate of the fixture.	
<i>After hot water tap is turned off, fan on water heater continues to run</i>	The fan is designed to continue running for a short time after the flow of water stops. This is to ensure constant water temperatures during rapid starting and stopping, as well as exhausting any residual gas flue products from the unit.	
<i>Display shows temperatures between 37° and 60°.</i>	Control is displaying temperature in Celsius.	<ul style="list-style-type: none"> <li>• Change control to Fahrenheit. See page 6.</li> </ul>

# Technical data.

**PRESSURE DROP CURVE**

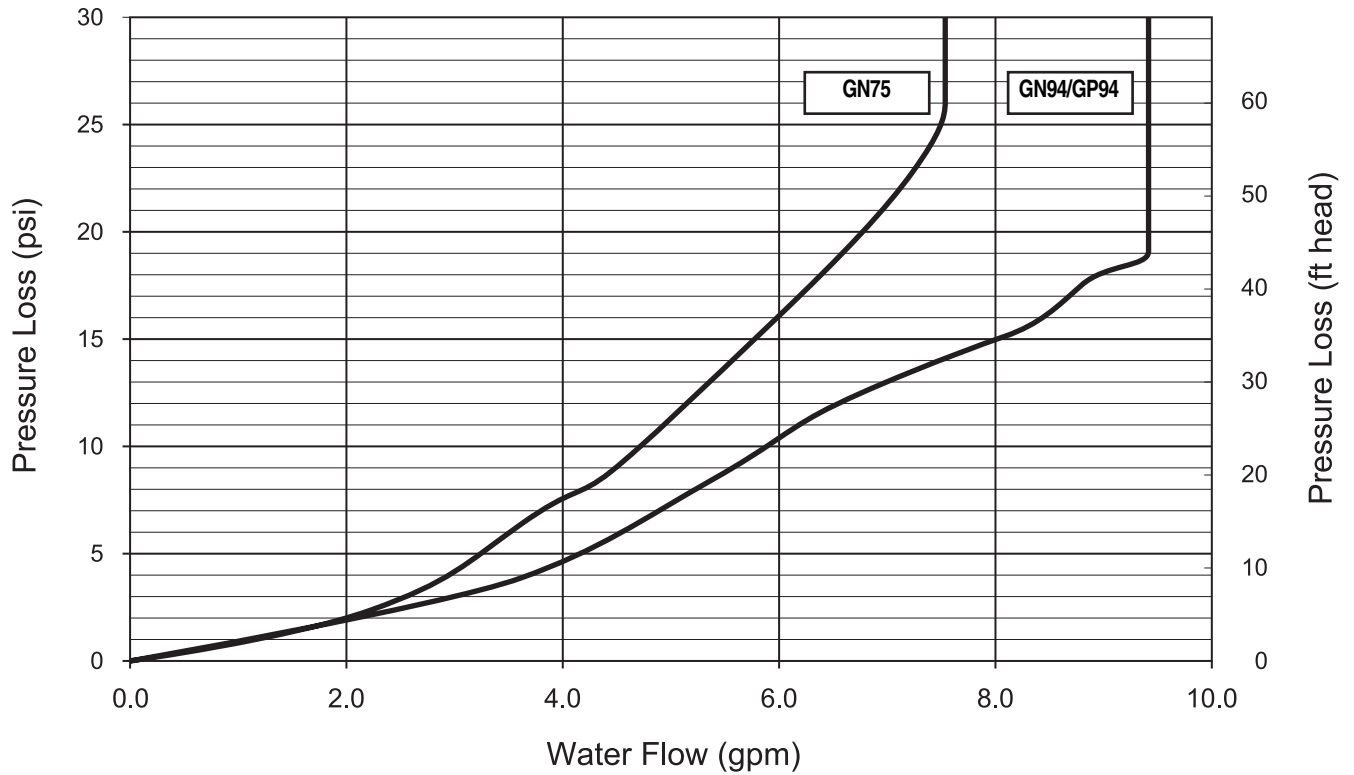

**OUTLET FLOW DATA**

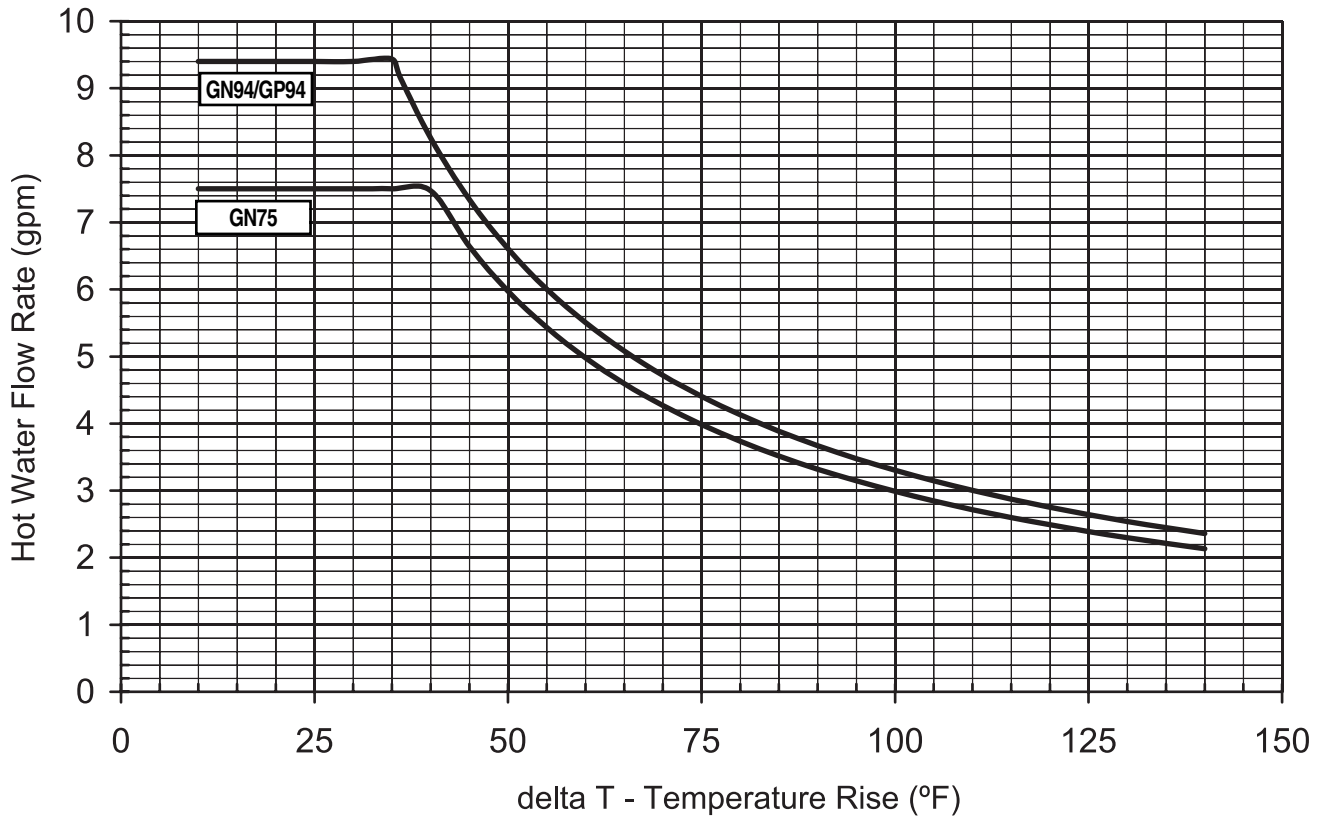

# GE Tankless Water Heater Warranty.



All warranty service provided by our Authorized Servicer Network. To schedule service, call 888.HOT.WATER (888.468.9837). Please have serial number and model number available when calling for service.

Staple your receipt here. Proof of the original purchase date is needed to obtain service under the warranty.

## For The Period Of: We Will Replace:

<b>One Year</b> From the date of the original purchase	<b>Any part</b> of the Tankless Water Heater which fails due to a defect in materials or workmanship. During this <b>limited one-year warranty</b> , GE will also provide, <b>free of charge</b> , all labor and related service to replace the defective part.
<b>Five Years</b> From the date of the original purchase	<b>Any part</b> of the Tankless Water Heater which fails due to a defect in materials or workmanship. During this <b>limited five-year parts warranty</b> , labor is not included.
<b>Ten Years</b> From the date of the original purchase	<b>Any part</b> of the heat exchanger which fails due to a defect in materials or workmanship. During this <b>limited ten-year warranty</b> , labor is not included.

## What Is Not Covered:

- Service trips to your home to teach you how to use the product.
- Improper installation, delivery or maintenance.
- Failure of the product if it is abused, misused, altered, used commercially or used for other than the intended purpose.
- Use of this product where water is microbiologically unsafe or of unknown quality, without adequate disinfection before or after the system.
- Failures due to poor water quality. See page 10 of this Owner's Manual for Water Quality Table.
- Replacement of house fuses or resetting of circuit breakers.
- Damage to the product caused by accident, lightning, fire, flood or acts of God.
- Incidental or consequential damage caused by possible defects with this appliance, its installation or repair.
- Product not accessible to provide required service.
- Failure of the product installed in a continuous recirculation system.
- If product removed from original installation location.
- Damages, malfunctions or failure caused by the use of unapproved parts or components.

**EXCLUSION OF IMPLIED WARRANTIES—Your sole and exclusive remedy is product repair as provided in this Limited Warranty. Any implied warranties, including the implied warranties of merchantability or fitness for a particular purpose, are limited to one year or the shortest period allowed by law.**

This warranty is extended to the original purchaser and any succeeding owner for products purchased for home use within the USA. If the product is located in an area where service by a GE Authorized Servicer is not available, you may be responsible for a trip charge or you may be required to bring the product to an Authorized GE Service location for service. In Alaska, the warranty excludes the cost of shipping or service calls to your home.

Some states do not allow the exclusion or limitation of incidental or consequential damages. This warranty gives you specific legal rights, and you may also have other rights which vary from state to state. To know what your legal rights are, consult your local or state consumer affairs office or your state's Attorney General.

**Warrantor: General Electric Company. Louisville, KY 40225**

# Consumer Support.

---



## GE Appliances Website

[ge.com](http://ge.com)

Have a question or need assistance with your appliance? Try the GE Appliances Website, any day of the year! For greater convenience and faster service, you can now download Owner's Manuals or order parts online.

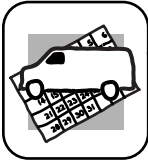

## Schedule Service

[ge.com](http://ge.com)

Expert GE repair service is only one step away from your door. Schedule your service at your convenience by calling 888.HOT.WATER (888.468.9837) during normal business hours.

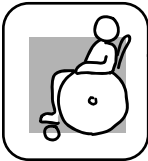

## Real Life Design Studio

[ge.com](http://ge.com)

GE supports the Universal Design concept—products, services and environments that can be used by people of all ages, sizes and capabilities. We recognize the need to design for a wide range of physical and mental abilities and impairments. For details of GE's Universal Design applications, including kitchen design ideas for people with disabilities, check out our Website today. For the hearing impaired, please call 800.TDD.GEAC (800.833.4322).



## Extended Warranties

[ge.com](http://ge.com)

Purchase a GE extended warranty and learn about special discounts that are available while your warranty is still in effect. You can purchase it on-line anytime, or call 800.626.2224 during normal business hours. GE Consumer Home Services will still be there after your warranty expires.

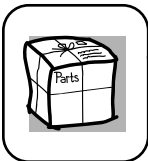

Individuals qualified to service their own appliances can have parts or accessories sent directly to their homes (VISA, MasterCard and Discover cards are accepted). Order on-line today, 24 hours every day or by phone at 800.626.2002 during normal business hours.

**Instructions contained in this manual cover procedures to be performed by any user. Other servicing generally should be referred to qualified service personnel. Caution must be exercised, since improper servicing may cause unsafe operation.**



## Contact Us

[ge.com](http://ge.com)

If you are not satisfied with the service you receive from GE, contact us on our Website with all the details including your phone number, or write to:

General Manager, Customer Relations  
GE Appliances, Appliance Park  
Louisville, KY 40225



## Register Your Appliance

[ge.com](http://ge.com)

**Register your new appliance on-line—at your convenience!** Timely product registration will allow for enhanced communication and prompt service under the terms of your warranty, should the need arise. You may also mail in the pre-printed registration card included in the packing material, or detach and use the form in this Owner's Manual.