



# SELECT CLEAN™ Self-Cleaning Gas Range

Use & Care Guide

# Cocina de gas de auto limpieza SELECT CLEAN™

Guía para el uso y cuidado

Models, Modelos 665.75832  
665.75834  
665.75839

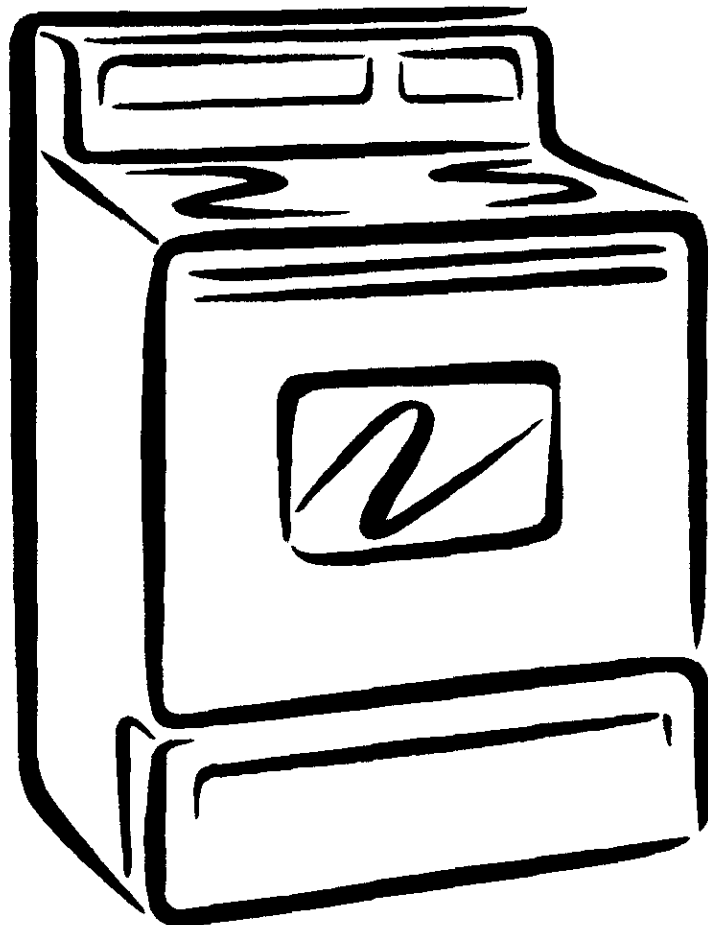

ENGLISH ESPAÑOL

TO THE INSTALLER: PLEASE LEAVE THIS INSTRUCTION BOOK WITH THE UNIT.  
TO THE CONSUMER: PLEASE READ AND KEEP THIS BOOK FOR FUTURE REFERENCE.

PARA EL INSTALADOR: FAVOR DE DEJAR ESTE MANUAL DE INSTRUCCIONES CON LA UNIDAD.

PARA EL CONSUMIDOR: FAVOR DE LEER Y GUARDAR ESTE MANUAL PARA FUTURAS REFERENCIAS.

**Super Capacity with ULTRABAKE™ System**  
**Capacidad extra con el Sistema ULTRABAKE™**

# Table of Contents

<b>A Note to You</b> .....	<b>2</b>
<b>Warranty</b> .....	<b>3</b>
<b>Range Safety</b> .....	<b>4</b>
<b>Parts and Features</b> .....	<b>6</b>
<b>Using Your Range</b> .....	<b>7</b>
Using the Surface Burners.....	7
Characteristics of Cookware Materials .....	8
Using the Oven.....	9
Bakeware Choices .....	10
Using Aluminum Foil .....	10
The Electronic Oven Control.....	11
Setting the Clock.....	12
Using the Oven Lockout.....	12
Using the Cooktop Lockout .....	13
Tones.....	13
Using the 12-Hour Shut-Off .....	13
Using the Electronic Kitchen Timer .....	14
Starting/Canceling a Function.....	15
ULTRABAKE™ Baking/Roasting .....	15
Readjusting the Oven Temperature Control...17	
Broiling .....	18
Using the Timed Oven Control .....	21
Using the Warm & Ready Warming Drawer .....	25
The Oven Vent .....	26
<b>Using the SELECT CLEAN™</b>	
<b>Self-Cleaning Cycle</b> .....	<b>27</b>
Before You Start .....	27
How the Cycle Works .....	28
Setting the Controls .....	28
<b>Caring for Your Range</b> .....	<b>31</b>
Cleaning Chart.....	31
Sealed Surface Burners and Cooktop.....	33
Removing the Oven Door .....	34
The Oven Light .....	36
<b>Troubleshooting</b> .....	<b>37</b>
Range Does Not Work .....	37
Oven/Broiler Burner.....	37
Surface Burners.....	38
When Self-Cleaning Your Oven.....	38
Cooking Results .....	39
Display Messages .....	39
<b>Index</b> .....	<b>40</b>
<b>Service</b> .....	<b>Back Cover</b>

# A Note to You

Thank you for buying a KENMORE appliance.

Your KENMORE gas range takes on a new value when you discover that Sears has service centers around the country. Trained Sears Service Professionals use fully-equipped trucks and Sears-approved methods for expert repairs backing up all Sears guarantees.

Please record your model's information.

Whenever you call to request service for your appliance, you need to know your complete model number and serial number. You can find this information on the model and serial number plate (see diagram in the "Parts and Features," p. 6).

Please also record the purchase date of your appliance and your store's name and telephone number.

**Model Number** 665.\_\_\_\_\_

**Serial Number** R\_\_\_\_\_

**Purchase Date** \_\_\_\_\_

**Keep this book and the sales slip together in a safe place for future reference.**



# Free-Standing Range Warranty

## FULL ONE YEAR WARRANTY ON ALL PARTS

If, within one year from the date of installation, any part fails to function properly due to a defect in material or workmanship, Sears will repair or replace it, at our option, free of charge.

If this product is subjected to other than private family use, the above warranty is effective for only 90 days.

WARRANTY SERVICE IS AVAILABLE BY CONTACTING THE NEAREST SEARS SERVICE CENTER IN THE UNITED STATES.

This warranty gives you specific legal rights and you may also have other rights which vary from state to state.

Sears Roebuck and Co. Dept. 817WA Hoffman Estates, IL 60179

## To Further Add To The Value Of Your Range, Buy a Sears Maintenance Agreement.

Years of Ownership Coverage	1st Year	2nd Year	3rdYear
1. Replacement of Defective Parts	W	MA	MA
2. Annual Preventive Maintenance Check at Your Request	MA	MA	MA

W = Warranty MA = Maintenance Agreement

Your Kenmore appliance is designed, manufactured and tested to provide years of dependable operation. Yet any major appliance may require service from time to time. The Sears Maintenance Agreement offers you an outstanding service program, affordably priced.

The table above shows the additional benefits a Sears Maintenance Agreement provides beyond the Sears Warranty. Contact your Sears Sales Associate or call 1-800-827-6655 to purchase a Sears Maintenance Agreement.

**WARNING: If the information in this manual is not followed exactly, a fire or explosion may result causing property damage, personal injury or death.**

- Do not store or use gasoline or other flammable vapors and liquids in the vicinity of this or any other appliance.
- **WHAT TO DO IF YOU SMELL GAS**
  - Do not try to light any appliance.
  - Do not touch any electrical switch.
  - Do not use any phone in your building.
  - Immediately call your gas supplier from a neighbor's phone. Follow the gas supplier's instructions.
  - If you cannot reach your gas supplier, call the fire department.
- Installation and service must be performed by a qualified installer, service agency or the gas supplier.

ENGLISH

# Range Safety

## Your safety and the safety of others are very important.

We have provided many important safety messages in this manual and on your appliance. Always read and obey all safety messages.



This is the safety alert symbol.

This symbol alerts you to potential hazards that can kill or hurt you and others.

All safety messages will follow the safety alert symbol and either the word "DANGER" or "WARNING." These words mean:

**⚠ DANGER**

You can be killed or seriously injured if you don't immediately follow instructions.

**⚠ WARNING**

You can be killed or seriously injured if you don't follow instructions.

All safety messages will tell you what the potential hazard is, tell you how to reduce the chance of injury, and tell you what can happen if the instructions are not followed.

## THE ANTI-TIP BRACKET

The range will not tip during normal use. However, the range can tip if you apply too much force or weight to the open door without the anti-tip bracket fastened down properly.



**⚠ WARNING**

### Tip Over Hazard

A child or adult can tip the range and be killed.

Connect anti-tip bracket to rear range foot.

Reconnect the anti-tip bracket, if the range is moved.

See the installation instructions for details.

Failure to follow these instructions can result in death or serious burns to children and adults.

### Anti-Tip Bracket

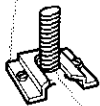

Range Foot

### Making sure the anti-tip bracket is installed:

- Slide range forward.
- Look for the anti-tip bracket securely attached to floor.
- Slide range back so rear range foot is under anti-tip bracket.

### Anti-tip bracket location

The illustration on the right shows the proper placement of the anti-tip floor bracket. To install correctly, see your installation instructions.

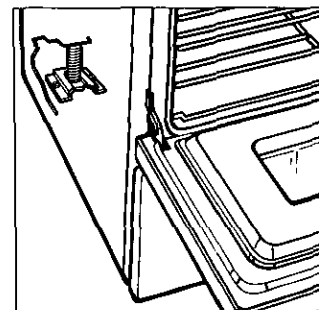

## IMPORTANT SAFETY INSTRUCTIONS

**WARNING:** To reduce the risk of fire, electrical shock, injury to persons, or damage when using the range, follow basic precautions, including the following:

- **WARNING:** To reduce the risk of tipping of the range, the range must be secured by properly installed anti-tip devices. To check if the devices are installed properly, slide range forward, look for anti-tip bracket securely attached to floor, and slide range back so rear range foot is under anti-tip bracket.
- **CAUTION:** Do not store items of interest to children in cabinets above a range or on the backguard of a range – children climbing on the range to reach items could be seriously injured.
- **Proper Installation –** The range, when installed, must be electrically grounded in accordance with local codes or, in the absence of local codes, with the *National Electrical Code, ANSI/NFPA 70*. In Canada, the range must be electrically grounded in accordance with Canadian Electrical Code. Be sure the range is properly installed and grounded by a qualified technician.
- This range is equipped with a three-prong grounding plug for your protection against shock hazard and should be plugged directly into a properly grounded receptacle. Do not cut or remove the grounding prong from this plug.

- Disconnect the electrical supply before servicing the appliance.
- Never Use the Range for Warming or Heating the Room.
- Injuries may result from the misuse of appliance doors or drawers such as stepping, leaning, or sitting on the doors or drawers.
- Maintenance – Keep range area clear and free from combustible materials, gasoline, and other flammable vapors and liquids.
- Storage in or on the Range – Flammable materials should not be stored in an oven or near surface units.
- Top burner flame size should be adjusted so it does not extend beyond the edge of the cooking utensil.

### For self-cleaning ranges –

- Before Self-Cleaning the Oven – Remove broiler pan and other utensils. Wipe off all excessive spillage before initiating the cleaning cycle.

## SAVE THESE INSTRUCTIONS

The California Safe Drinking Water and Toxic Enforcement Act requires the Governor of California to publish a list of substances known to the State of California to cause cancer, birth defects, or other reproductive harm, and requires businesses to warn of potential exposure to such substances.

**WARNING:** This product contains a chemical known to the State of California to cause cancer, birth defects, or other reproductive harm.

This appliance can cause low-level exposure to some of the substances listed, including benzene, formaldehyde, carbon monoxide, toluene, and soot.

# Parts and Features

Oven vent  
(p. 26)

Sealed surface burners  
(pp. 7, 8, 33, 34)

Cooktop  
grates  
(p. 31)

Power Burner  
(p. 7)

Anti-tip bracket  
(p. 4)

Door stop clip  
(pp. 34-36)

Model and  
serial number  
plate  
(behind left side  
of warming drawer)

Warm & Ready  
warming drawer  
(p. 25, 26)

Electronic oven  
control  
(pp. 11-24)

SURESIMMER™  
burner  
(p. 7)

Control panel  
(pp. 6, 31)

Automatic oven  
light switch  
(p. 36)

Gasket  
(p. 27)

STURDIGLIDE™  
HALF-RACK with  
removable insert  
(p. 9)

STURDIGLIDE™  
oven rack with  
integrated  
handle  
(p. 9)

## CONTROL PANEL

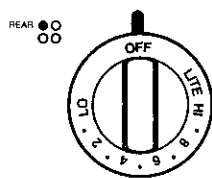

Left rear  
control knob

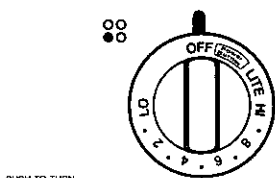

Left front control knob  
(Power Burner)  
(p. 7)

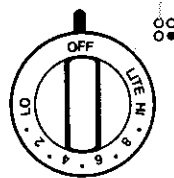

Right front  
control knob



Right rear control knob  
(SURESIMMER setting)  
(p. 7)

WARM & READY  
selector switch  
(p. 25)

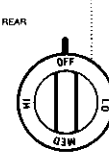

## ELECTRONIC OVEN CONTROL

ULTRABAKE™ electronic display (p. 11)

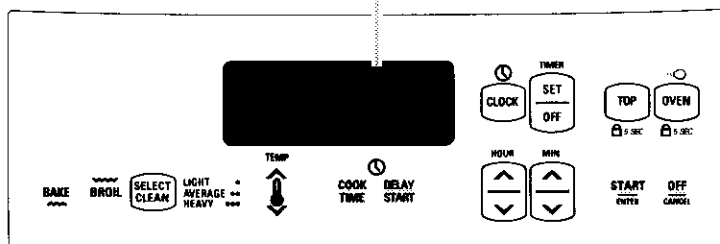

# Using Your Range

## USING THE SURFACE BURNERS

### ⚠ WARNING



#### Fire Hazard

Do not let the burner flame extend beyond the edge of the pan.

Turn off all controls when not cooking.

Failure to follow these instructions can result in death or fire.

**NOTE:** Unit is shipped with the surface burners in the Cooktop Lockout position and must be unlocked before they can be used. See "Using the Cooktop Lockout," p.13.

### Using the control knobs

Your range comes with electric ignitors that light the burners each time you turn the control knobs to LITE.

- Place a filled pan on the burner grate before turning on the surface burner. Do not operate a burner for extended periods of time without having cookware on the grate.
- Push in the control knob and turn it **counter-clockwise** to the LITE position. The clicking sound is the ignitor sparking. Make sure the burner has lit.

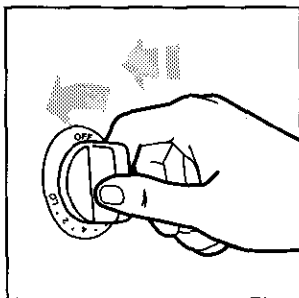

● Stop the clicking sound after the burner lights by turning the control knob anywhere between HI and LO.

**NOTES:**

- Do not try to light the surface burners during a power failure.
- All four electric ignitors will click at the same time. However, the burner with the control knob turned to LITE is the one that will ignite.

**REMEMBER:** When range is in use or during the Self-Cleaning cycle, the entire cooktop area may become hot.

### Burner heat settings

Use the following chart as a guide.

SETTING	RECOMMENDED USE
LITE	<ul style="list-style-type: none"><li>● To light the burner.</li></ul>
Power Burner (left front burner)	<ul style="list-style-type: none"><li>● To provide highest heat setting.</li></ul>
HI	<ul style="list-style-type: none"><li>● To start food cooking.</li><li>● To bring liquid to a boil.</li></ul>
Mid-range (between HI and LO)	<ul style="list-style-type: none"><li>● To hold a boil.</li><li>● To fry chicken or pancakes.</li><li>● To cook gravy, pudding, or icing.</li><li>● To cook large amounts of vegetables.</li></ul>
LO	<ul style="list-style-type: none"><li>● To keep food warm.</li><li>● To simmer.</li></ul>
SURESIMMER™ setting (right rear burner)	<ul style="list-style-type: none"><li>● To provide lowest simmer/heat setting.</li><li>● To melt chocolate or butter.</li></ul>

**NOTE:** Do not leave empty cookware, or cookware which has boiled dry, on a hot surface burner. The cookware could overheat, causing damage to the cookware or cooking product.

### Using Power Burner

The left front burner is designed to give ultra-high power when it is fully on. It can be used to rapidly bring liquid to a boil and to cook large quantities of food.

### Using SURESIMMER

The right rear SURESIMMER burner is designed for low temperature cooking. It allows accurate simmer control at the lowest setting.

### Easy ways to save energy

- To help shorten your cooking time, use the least amount of liquid possible.
- Start your food on a higher heat setting, then turn the control to a lower setting to finish cooking.

## USING THE SURFACE BURNERS (contd.)

### Home canning information

The large diameter of most water-bath or pressure canners combined with high heat settings for long periods of time can cause damage to the cooktop.

#### To protect your range:

- Center the canner over the surface burner. Do not extend more than 1 inch outside the burner area.
- Do not place your canner on two surface burners at the same time.
- Start with hot water, cover with a lid and bring to a boil; then reduce heat to maintain a boil or required pressure levels in a pressure canner.
- Refer to your canner manual for specific instructions.

For up-to-date information on canning, contact your local U.S. Government Agricultural Department Extension Office or companies who manufacture home canning products.

### Using the right cookware makes a big difference

- The pan should have a flat bottom, straight sides, and a well-fitting lid.
- Choose medium to heavy gauge (thickness) cookware.
- The pan material (metal or glass) affects how quickly and evenly the pan heats.
- When using glass or ceramic cookware, check to make sure it is suitable for use on surface burners.
- To avoid tipping, make sure pots and pans are centered on the grates.

## CHARACTERISTICS OF COOKWARE MATERIALS

The pan material affects how fast heat transfers from the surface cooking area through the pan material and how evenly heat spreads over the pan bottom. Choose pans that provide the best cooking results.

Aluminum	<ul style="list-style-type: none"> <li>• Heats quickly and evenly.</li> <li>• Use for all types of cooking.</li> <li>• Medium or heavy thickness is best for most cooking.</li> <li>• Used as a core or base in cookware to provide even heating.</li> </ul>
Cast iron	<ul style="list-style-type: none"> <li>• Heats slowly and evenly.</li> <li>• Good for browning and frying.</li> <li>• Maintains heat for slow cooking.</li> <li>• Can be coated with porcelain enamel.</li> </ul>
Ceramic or ceramic glass	<ul style="list-style-type: none"> <li>• Heats slowly and unevenly.</li> <li>• Use on low to medium settings.</li> <li>• Follow manufacturer's instructions.</li> </ul>
Copper	<ul style="list-style-type: none"> <li>• Heats very quickly and evenly.</li> <li>• Used as a core or base in cookware to provide even heating.</li> </ul>
Earthenware	<ul style="list-style-type: none"> <li>• Can be used for cooktop cooking if recommended by the manufacturer.</li> <li>• Use on low settings.</li> </ul>
Porcelain enamel-on-steel or enamel-on-cast iron	<ul style="list-style-type: none"> <li>• See cast iron and stainless steel.</li> </ul>
Stainless steel	<ul style="list-style-type: none"> <li>• Heats quickly but unevenly.</li> <li>• A core or base of aluminum or copper on the cookware provides even heating.</li> <li>• Can be coated with porcelain enamel.</li> </ul>



# USING THE OVEN

## STURDIGLIDE™ oven rack with integrated handle

The integrated handle area makes pulling out the STURDIGLIDE rack simple. The opening is large enough for a potholder or oven mitt.

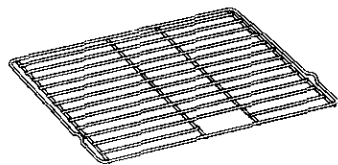

## STURDIGLIDE™ HALF-RACK with removable insert

The STURDIGLIDE™ HALF-RACK with removable insert is a space maximizer. When attached, they make a full rack. The insert can also be used on the counter for a cooling rack.

Position a full rack on guide 1 or 2 and the half-rack on guide 3 or 4. On the full rack place large items on right side and deeper, covered dishes on left side. Place shallow dishes on the half-rack. It may be necessary to increase cooking time. At the end of cooking, carefully remove items from the oven.

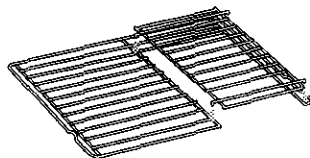
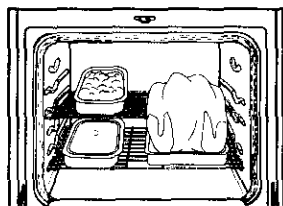

## Positioning racks and pans

Place the STURDIGLIDE racks where you need them before turning on the oven.

- To move a rack, pull it out to the stop position, raise the front edge and lift it out.
- Be sure the rack(s) is level.
- Use pot holders or oven mitts to protect your hands if rack(s) must be moved while the oven is hot.
- For best performance, cook on one rack. Place the rack so the top of the food will be centered in the oven.
- When cooking with two racks, arrange the racks on the 2nd and 4th rack guides. Two sheets of cookies may be baked if sheets are switched at approximately three quarters of the total bake time. Increase baking time, if necessary.

- For best results allow 2 inches of space around each pan and between pans and oven walls. Hot air must circulate around the pans in the oven for even heat to reach all parts of the oven. This results in better baking.

## Extra oven rack position (roasting rack)

Use this rack position when roasting food too large to be placed on the first rack position.

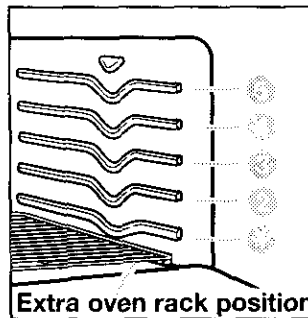

**For proper roasting, follow these guidelines:**

- To avoid spillage, remove food before pulling out the rack.
- Tilt the rack up at the front before pulling it over the door.
- Use an adequate amount of liquid in the pan (meat juices or water) so your food does not get overdone.

## Where to place pans:

WHEN YOU HAVE	PLACE
1 pan	In center of the oven rack.
2 pans	Side by side or slightly staggered.
3 or 4 pans	In opposite corners on each oven rack. Stagger pans so no pan is directly over another.

## Rack placement for specific foods:

FOOD	RACK POSITION
Frozen pies, large roasts, turkeys, angel food cakes	1st or 2nd rack guide from bottom
Bundt cakes, most quick breads, yeast breads, casseroles, meats	2nd rack guide from bottom
Cookies, biscuits, muffins, cakes, nonfrozen pies	2nd or 3rd rack guide from bottom

**NOTE:** For information on where to place your rack when broiling, see "Broiling guidelines," pp. 19, 20.

## BAKEWARE CHOICES

Baking performance is affected by the type of bakeware used. Use the bakeware size recommended in the recipe.

BAKEWARE TYPE	BEST USED FOR	GUIDELINES
Light colored aluminum	<ul style="list-style-type: none"> <li>• Light golden crusts</li> <li>• Even browning</li> </ul>	<ul style="list-style-type: none"> <li>• Use temperature and time recommended in recipe.</li> </ul>
Dark aluminum and other bakeware with dark, dull, and/or non-stick finish	<ul style="list-style-type: none"> <li>• Brown, crisp crusts</li> </ul>	<ul style="list-style-type: none"> <li>• May reduce baking temperature 25°F.</li> <li>• Use suggested baking time.</li> <li>• Use temperature and time recommended in recipe for pies, breads, and casseroles.</li> <li>• Place rack in center of oven.</li> </ul>
Ovenproof glassware, ceramic glass, or ceramic	<ul style="list-style-type: none"> <li>• Brown, crisp crusts</li> </ul>	<ul style="list-style-type: none"> <li>• May reduce baking temperature 25°F.</li> </ul>
Insulated cookie sheets or baking pans	<ul style="list-style-type: none"> <li>• Little or no bottom browning</li> </ul>	<ul style="list-style-type: none"> <li>• Place in the bottom third of oven.</li> <li>• May need to increase baking time.</li> </ul>
Stainless steel	<ul style="list-style-type: none"> <li>• Light, golden crusts</li> <li>• Uneven browning</li> </ul>	<ul style="list-style-type: none"> <li>• May need to increase baking time.</li> </ul>
Stoneware	<ul style="list-style-type: none"> <li>• Crisp crusts</li> </ul>	<ul style="list-style-type: none"> <li>• Follow manufacturer's instructions.</li> </ul>



## USING ALUMINUM FOIL

- **Do not line the oven bottom with any type of foil, liners, or cookware. Permanent damage will occur to the oven bottom finish.**
- **Do not block the oven bottom vents.**
- **Do not cover** the entire rack with aluminum foil. Doing so will reduce air circulation and overall oven performance.
- **To catch spillovers** from pies or casseroles place foil on the oven rack below. Foil should be turned up at edges and be at least 1 inch larger than dish.
- **Place tent-shaped foil** loosely over meat or poultry to slow down surface browning for long term roasting. Remove foil for the last 30 minutes.
- **Use narrow strips** of foil to shield piecrust edges if browning too quickly.

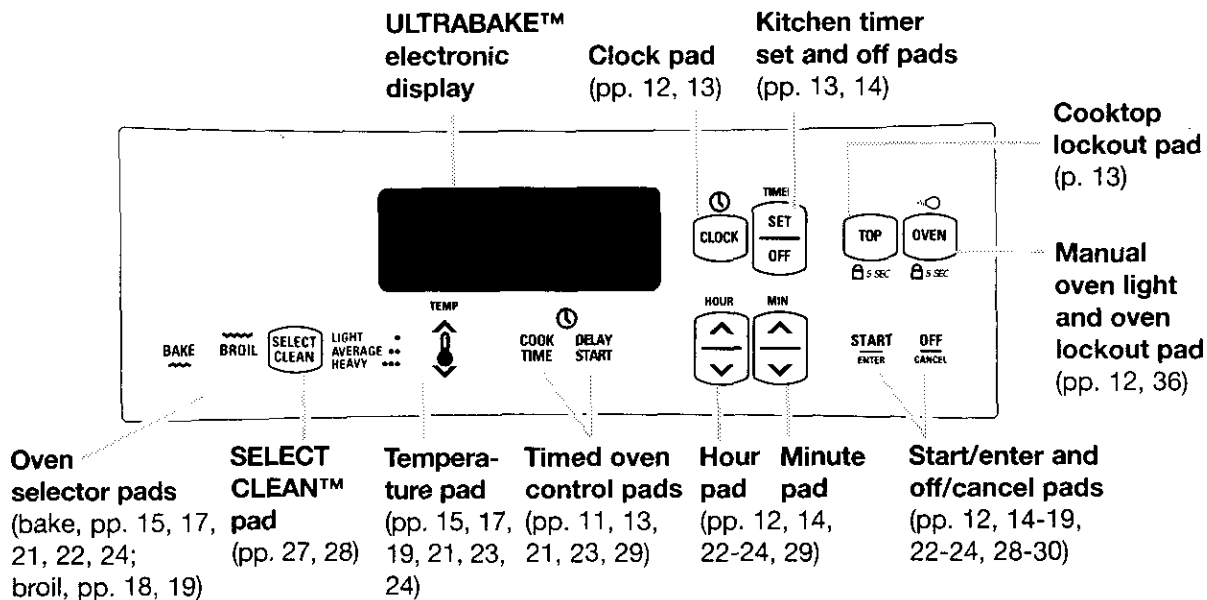
# THE ELECTRONIC OVEN CONTROL



## Display/clock

- After you install the range according to the installation instructions and connect the power supply, make sure surface burners are in the OFF position. Everything on the display will light up for about 5 seconds. The time of day, "PF", and  will appear on the display. Press OFF/CANCEL to clear "PF" from the display. To unlock the surface burners (see "Using the Cooktop Lockout," p.13). If after you set the clock (see "Setting the clock," p.12), "PF" and  again appears on the display, your electricity was off for a while indicating a Power Failure. Reset the clock and enable the surface burners, if needed.
- When you are not using the oven, the display will show the time of day.
- When you are using the oven or kitchen timer, the display will show times, temperature settings, and what command pads have been pressed.
- You can find out what time the oven turned on or is going to turn on when the display is active by pressing DELAY START.
- When showing the time of day, the display will show the hour and minutes.
- When you are using the kitchen timer, the display will show minutes and seconds in the following sequence:
  - For settings from 1 to 59 minutes, the display will count down each second.
  - For settings one hour or over, the display will count down each minute.
- When you are using COOK TIME and DELAY START, the display will show hours and minutes or minutes and seconds.



## SETTING THE CLOCK

1. Press CLOCK.

PRESS



YOU SEE (denotes blinking)



(example for 12:00)

2. Set the time.

Press the HOUR/MIN (▲) or (▼) pad(s) until the correct time of day shows on the display.

PRESS

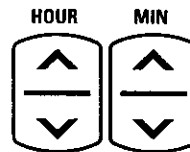

YOU SEE



(example for 5:30)

3. Press START/ENTER or CLOCK.

**NOTE:** This is a 12-hour clock. It does not show a.m. or p.m.

PRESS

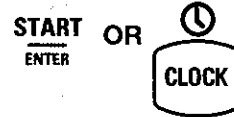

YOU SEE



## USING THE OVEN LOCKOUT

The oven lock lets you prevent use of the control panel command keypads. This feature comes in handy when cleaning the control panel to avoid accidentally turning on the oven.

**NOTE:** You can only lock the oven when the oven is not in use or the control has not been set. The oven will remain locked after a power failure if it was locked before the power failure.

### To lock the oven:

Press and hold the OVEN keypad for 5 seconds.

You will hear a single tone and "Loc" and will appear on the display. Three tones will sound when the oven is locked and you press any command pad other than CLOCK, TIMER, START/ENTER, OFF/CANCEL, TOP or OVEN.

### To unlock the oven:

Press and hold the OVEN keypad for 5 seconds.

You will hear a single tone and "Loc" and will disappear from the temperature display.

## USING THE COOKTOP LOCKOUT

The cooktop lock prevents unintended use of the cooktop burners by shutting off the gas flow to the burners. Unit is shipped with the surface burners in the Cooktop Lockout position, and must be unlocked before they can be used. The Cooktop Lockout will be engaged when appliance is first plugged in.

### NOTES:

- The cooktop will remain locked after a power failure if it was locked before the power failure.
- If the product loses power, appliance will automatically go into the lockout position. You will be unable to activate the burners until power is restored, and the Cooktop Lockout is disengaged.

### To lock the cooktop:

1. Turn all burners to the OFF position.
2. Press and hold the TOP keypad for 5 seconds. You will hear a single tone and "Loc on" will show in the display for 5 seconds. Then  will appear on the display.



### To unlock the cooktop:

1. Turn all burners to the OFF position.
2. Press and hold the TOP keypad for 5 seconds. You will hear a single tone and "Loc OFF" will show in the display for 5 seconds  will disappear from the display.



## TONES

**Keypad tones** let you know a keypad has been pushed.

### To remove keypad tones:

Press and hold the COOK TIME keypad for 5 seconds. You will hear a short tone and see "Snd OFF" when the keypad tones are turned off.

**COOK  
TIME**

### To bring back keypad tones:

Press and hold the COOK TIME keypad for 5 seconds. You will hear a short tone and see "Snd on" when the keypad tones are turned on.

**COOK  
TIME**

**Repeater tones** are four 1-second tones which remind you that the set time has expired for a kitchen timer or a timed oven control function.

### To remove repeater tones:

Press and hold the SET keypad for 5 seconds. You will hear a short tone and see "rEP OFF" when the repeater tones are turned off.



### To bring back repeater tones:

Press and hold the SET keypad for 5 seconds. You will hear a short tone and see "rEP on" when the repeater tones are turned on.



**Error tones** indicate a problem with the electronic oven control. An error code will appear in the display. See "Display Messages" in the "Troubleshooting" section, p. 39.

**Volume** can be adjusted between high and low.

### To adjust:

Press and hold the DELAY START keypad for 5 seconds. You will hear a short tone and see either "Snd HI" or "Snd Lo". Press and hold the DELAY START keypad again for 5 seconds to change to desired setting.

**NOTE:** You can remove "Snd on", "Snd OFF", "rEP on", "rEP OFF", "Snd HI" or "Snd Lo" from the display and bring back the time of day by pressing any key.

## USING THE 12-HOUR SHUT-OFF

The oven control can be set to automatically shut the oven off 12 hours after the oven turns on. This will not interfere with any timed or delayed cook function.

### To override the 12-hour shut-off:

For longer cooking periods and for religious observances that require oven usage longer than 12 hours, press and hold the CLOCK keypad for 5 seconds. You will hear a tone and see "12H OFF" when the feature is off. The oven will remain on until turned off by the user.

**NOTE:** The oven light will come on when the oven door is opened. To keep the light on continuously, turn the light on, by pressing the OVEN keypad. See instructions, p. 36.

### To reset the 12-hour shut-off:

Press and hold the CLOCK keypad for 5 seconds. You will hear a tone and see "12H on" when the feature is on. The oven will automatically turn off after 12 hours.

## USING THE ELECTRONIC KITCHEN TIMER

The kitchen timer allows you to monitor time for cooking and other tasks. It does not start or stop the oven. See the "Using the Timed Oven Control" section (p. 21) to start and stop the oven automatically. It can be set in hours and minutes up to 12 hours, 59 minutes. The kitchen timer will display minutes and seconds for settings under 1 hour. You will hear four 1-second tones when the set time is up.

### To set the kitchen timer:

1. Press **TIMER SET**.

**PRESS**



**YOU SEE**



2. Set the time.

Press the **HOUR/MIN** (▲) or (▼) pad(s) until the correct length of time shows on the display.

**PRESS**

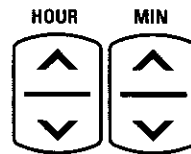

**YOU SEE**



(example for 10 minutes)

3. Press **START/ENTER** or **TIMER SET**.

The kitchen timer will begin counting down immediately after the timer is started. The display will count down in hours and minutes (if remaining time is one hour or more) and in minutes and seconds (if remaining time is less than one hour).

**PRESS**

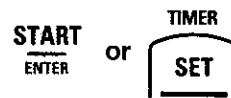

**YOU SEE**



(display counts down)

When the time is up:

You will hear four 1-second tones, then four 1-second repeater tones every minute until you press **TIMER OFF**.

**YOU SEE**



### To turn off or cancel the kitchen timer:

1. Press **TIMER OFF**.

**PRESS**



**YOU SEE**



(time of day)

## STARTING/CANCELING A FUNCTION

After setting a function, you must press **START/ENTER** to start the function. If you do not press **START/ENTER** within 5 seconds of setting, "START?" will show on the display as a reminder. If you do not press **START/ENTER** within 5 minutes of setting, the time of day will appear. You must reset the function and press **START/ENTER**.

**START**  
**ENTER**

**OFF/CANCEL** will cancel any function except the Clock, Timer, or Oven/Cooktop Lockouts. When you press **OFF/CANCEL**, the display will show the time of day or, if the minute timer is also being used, the time remaining.

**OFF**  
**CANCEL**

## ULTRABAKE™ BAKING/ROASTING

Your oven is designed with the ULTRABAKE™ enhanced baking system to constantly monitor oven temperature. The bake burner will cycle, as needed, to maintain the desired temperature. This feature is automatically activated when the oven is in operation.

### IMPORTANT:

- When using the oven for the first time, it is necessary to light the surface burners first to purge air from the gas line.
- Do not try to light the oven burner during a power failure.
- Never place food or cookware directly on the oven door or the oven bottom.

1. Place the STURDIGLIDE™ rack(s) where you need them in the oven. For more information, see the "Positioning racks and pans" section, p. 9.

2. Press **BAKE**.

**PRESS**

**BAKE**  
⌞

**YOU SEE**



3. Set the temperature (optional).

Do this step if you want to set a temperature other than 350°F. Press **TEMP** (▲) or (▼) pad(s) to raise or lower the temperature in 5°F amounts. Use these pads until the desired temperature shows on the small display.

**PRESS**

**TEMP**



**YOU SEE**



(example for bake at 375°F)

continued on next page

# ULTRABAKE™ BAKING/ROASTING (contd.)

4. When roasting, preheating the oven is not necessary unless your recipe recommends it.

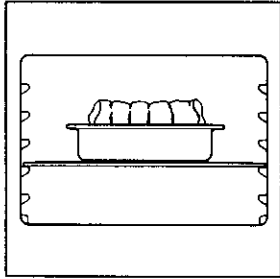

**NOTE:** The oven will heat normally even though "PrE HEAt" is displayed and then maintain the selected cooking temperature.

## Roasting meats and poultry

- For even cooking, place the meat on a rack in a shallow pan. This keeps the meat out of the drippings and allows the heat to circulate better.
- Use a meat thermometer for the most accurate doneness. Insert it so the tip is in the center of the largest muscle or thickest portion of the meat or poultry. Make sure the thermometer is not touching bone, fat, or the bottom of the pan.

5. Press START/ENTER.

A preheat mode is entered after the oven temperature has been set and START has been pressed. Once the preheat conditioning ends, the selected oven temperature replaces "PrE HEAt" on the display. You will hear a 1-second tone, indicating the oven is ready to use.

The ULTRABAKE™ system electronically regulates the preheat and temperature to maintain a precise temperature range for the best cooking results.

### NOTES:

- You can change the temperature setting any time after pressing START/ENTER. You do not have to press START/ENTER again.
- While the oven is in the preheat mode, you can see the set temperature for 5 seconds by pressing BAKE.

PRESS

START  
ENTER

YOU SEE



YOU SEE



(example for set temperature of 350°F)

6. When baking, put your food in the oven after the preheat conditioning ends. During baking/roasting, the oven burner will turn on and off to keep the oven temperature at the setting.

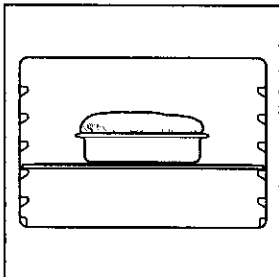

## Saving energy

- To avoid loss of heat, open the oven door as little as possible.
- Use the timer to keep track of cooking time.
- Plan your meals for the most efficient use of the oven by cooking more than one food at a time, or baking while the oven is still hot after cooking a meal.

7. After cooking, turn off the oven.

PRESS

OFF  
CANCEL

YOU SEE



(time of day)



# READJUSTING THE OVEN TEMPERATURE CONTROL (OPTIONAL)

Although your new oven is properly adjusted to provide accurate temperatures, it may cook faster or slower than your old oven.

If you are not satisfied with the baking/roasting results, you can change the temperature calibration by following the steps below.

**NOTE:** DO NOT measure the oven temperature with a thermometer. Opening the oven door will lower the oven temperature and give you an incorrect reading. Also, the thermometer temperature reading will change as your oven cycles.

1. Press and hold BAKE for 5 seconds.

The display will show the current temperature calibration, for example "0," if you have not already adjusted the temperature.

**PRESS**



**YOU SEE**

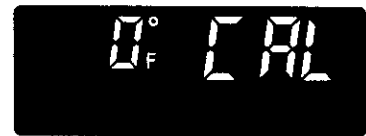

(factory setting of "0")

2. Set the new offset temperature.

Press TEMP (▲) or (▼) pad(s) to raise or lower the temperature in 10°F amounts. You can set the temperature change to as low as -30°F or as high as +30°F. A minus (-) sign will appear before the number when decreasing the temperature setting. The minus sign shows the oven will be cooler by the displayed amount. There is no sign in front of the number when increasing the temperature setting.

**PRESS**

TEMP



**YOU SEE**



(example when making oven 10°F warmer)

3. Enter the adjustment.

**NOTE:** You must press START/ENTER after adjusting the calibration or your changes will not be made.

**PRESS**



**YOU SEE**



(time of day)

## How to determine the amount of adjustment needed

The chart at the right tells you how much to adjust the temperature calibration to get the cooking results you want. You can figure out cooking results by the amount of browning, moistness, and rising times for baked foods.

TO COOK FOOD ...	ADJUST BY THIS NUMBER OF DEGREES (FAHRENHEIT)
A little more	+10
Moderately more	+20
Much more	+30
A little less	-10
Moderately less	-20
Much less	-30

## To display temperatures in °C instead of °F:

Press and hold BROIL for 5 seconds. You will hear a  short tone and the temperatures displayed will switch to °C. To switch back to °F, repeat the instructions above. Whenever you switch, "°C" or "°F" will be displayed until another key is pressed.

ENGLISH

# BROILING

For best results, do not preheat when broiling unless your recipe recommends it.

1. Place the STURDIGLIDE™ rack so that the surface of the food is no less than 3 inches away from the broil burner. See “Broiling guidelines,” pp. 19, 20.

2. Put your food on the broiler pan and place the pan in the center of the oven rack. Close the door.

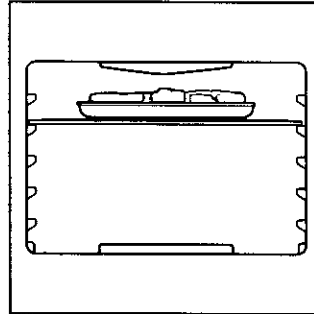

3. Press BROIL.

**PRESS**

  
BROIL

**YOU SEE**

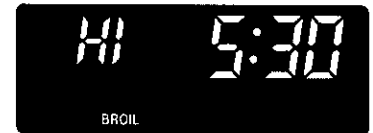

4. Press START/ENTER.

You can change the temperature setting any time before or after pressing START/ENTER. To change the temperature, see “Precision broiling” later in this section.

**PRESS**

  
START  
ENTER

**YOU SEE**



5. After broiling, turn off the oven.

**PRESS**

  
OFF  
CANCEL

**YOU SEE**



(time of day)

## BROILING (contd.)

### Precision broiling

Use precision broiling if your food is cooking too fast or if you want your food to broil slower from the start. The lower the temperature, the slower the cooking. Thicker cuts and unevenly shaped pieces of meat, fish and poultry may cook better if you use lower broiling temperatures.

1. Press BROIL.

PRESS



YOU SEE

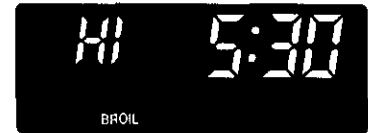

2. Press the TEMP (▼) keypad to lower the temperature in 5°F amounts. The broil range is 170°F - HI (525°F).

PRESS



YOU SEE



(example shows broil at 400°F)

3. Press START/ENTER.

PRESS



### Broiling guidelines

- Use only the broiler pan and grid provided. They are designed to drain extra juices from the cooking surface. This drainage helps prevent spatter and smoke.
- To make sure the juices drain well, do not cover the grid with foil.
- Trim excess fat to reduce spattering. Slit the fat on the edges to prevent curling.
- Use tongs to turn meat to avoid losing juices.
- Pull out oven rack to stop position before turning or removing food.
- After broiling, remove the pan from the oven when removing the food. Drippings will bake on the pan if left in the heated oven, making cleaning more difficult.
- For easier cleaning, line the bottom of the pan with aluminum foil. Clean the pan and grid as soon as possible after each use.

continued on next page

## BROILING (contd.)

### Broiling guidelines (contd)

Recommended rack positions are numbered from the bottom (1) to the top (5). For best results, place food 3 inches or more from the broil burner. Times are guidelines only and may need to be adjusted for individual tastes.

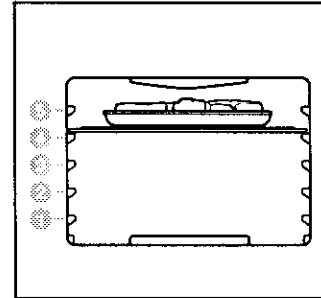

### Conventional/Precision Broil

MEAT	RACK POSITION	BROIL SETTING	APPROXIMATE TIME (MINUTES)	
			SIDE 1	SIDE 2
<b>Steak, 1" thick</b>	4	HI		
medium rare			14-15	7-8
medium			15-16	8-9
well done			18-19	9-10
<b>Ground Meat Patties, ¾" thick, well done</b>	4	HI	13-14	6-7
<b>Pork Chops, 1" thick</b>	4	HI	18-21	8-10
<b>Ham Slice, ½" thick precooked</b>	4	HI	8-10	4-5
<b>Bacon, thick sliced</b>	4	500°F	8-9	1-2
<b>Frankfurters</b>	4	HI	6-7	3-4
<b>Lamb Chops, 1" thick</b>	4	HI	15-17	8-9
<b>Chicken</b>				
bone-in pieces	3	HI	20-24	15-18
boneless breasts	4	HI	12-16	11-16
<b>Fish</b>	4			
fillets ¼-½" thick		HI	8-10	4-5
steaks ¾-1" thick		500°F	13-15	10-13

# USING THE TIMED OVEN CONTROL

## ⚠ WARNING

### Food Poisoning Hazard

Do not let food sit in oven more than one hour before or after cooking.

Doing so can result in food poisoning or sickness.

The Timed Oven control will turn the oven on at a set time of day, cook for a set length of time, then shut off automatically when programmed. You can do this by setting the COOK TIME and DELAY START. **Before using the Timed Oven control, make sure the clock is set to the correct time of day.** (See "Setting the clock," p. 12.)

**To Start now and Stop automatically:**

Set COOK TIME

**To Delay Start and Stop automatically:**

Set COOK TIME and DELAY START

**NOTE:** Delayed time cooking is ideal for foods that do not need a preheated oven, like meats and casseroles. Do not use a delayed time function when baking.

### To start now and stop automatically:

To use this function, it is necessary to program the COOK TIME.

- Place the STURDIGLIDE™ rack(s) where you need them and put your food in the oven. To place your racks correctly, see "Positioning racks and pans" section, p. 9.

- Press BAKE.

PRESS



YOU SEE



- Set the temperature (optional).

Do this step if you want to set a temperature other than 350°F. Press TEMP (▲) or (▼) pad(s) to raise or lower the temperature in 5°F amounts. Use these pads until the desired temperature shows on the small display.

PRESS

TEMP



YOU SEE



(example shows bake at 375°F)

- Press COOK TIME

PRESS



YOU SEE



continued on next page

ENGLISH

## USING THE TIMED OVEN CONTROL (contd.)

### 5. Set the cook time.

Press the HOUR/MIN (▲) or (▼) pad(s) until the correct cook time shows on the display.

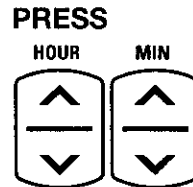

### YOU SEE



(example shows 30-minute baking/roasting time)

### 6. Press START/ENTER.

#### NOTES:

- You can change the temperature or time settings any time after pressing START/ENTER by repeating Steps 3 or 5. You do not have to press START/ENTER again.
- The display will count down the baking/roasting time in hours and minutes (if cook time is more than 1 hour) or in minutes and seconds (if cook time is less than 1 hour).

### PRESS



### YOU SEE



(display counts down cook time)

### 7. When cook time ends the oven will automatically shut off. End and COOK TIME will show in the display. You will hear four tones then four 1-second repeater tones every minute.

### YOU SEE



### 8. Press OFF/CANCEL to stop repeater tones and remove End from display and bring back the time of day.

**NOTE:** You can do this step any time to cancel the Timed Oven control setting.

### PRESS



### YOU SEE



(time of day)

### To program COOK TIME and DELAY START:

**IMPORTANT:** If you program DELAY START without programming COOK TIME, the oven will start at the programmed time, but will **NOT stop** until you press OFF/CANCEL.

1. Place the STURDIGLIDE™ rack(s) where you need them and put your food in the oven. To place your racks correctly, see "Positioning racks and pans" section, p. 9.

### 2. Press BAKE.

### PRESS



### YOU SEE



## USING THE TIMED OVEN CONTROL (contd.)

**3. Set the temperature (optional).**

Do this step if you want to set a temperature other than 350°F. Press TEMP ▲ to raise the temperature or ▼ to lower the temperature in 5°F amounts. Use these pads until the temperature you want shows on the small display.

**PRESS**

TEMP



**YOU SEE**



(example shows bake at 375°F)

**4. Press COOK TIME.**

**PRESS**

COOK  
TIME

**YOU SEE**



**5. Set the cook time.**

Press the HOUR/MIN (▲) or (▼) pad(s) until the correct cook time shows on the display.

**PRESS**

HOUR

MIN

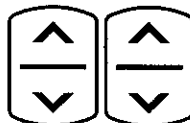

**YOU SEE**



(example shows 30-minute baking/roasting time)

**6. Press DELAY START.**

**PRESS**

DELAY  
START

**YOU SEE**



**7. Set the time of day to start.**

Press the HOUR/MIN (▲) or (▼) pad(s) until the correct time of day to start shows on the display.

The example at the right shows a chosen start time of 1:00. The oven will shut off by itself at 1:30 (the set start time plus the set cook time).

**PRESS**

HOUR

MIN

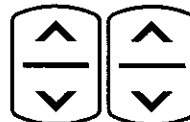

**YOU SEE**



(example shows 1:00 start time)

**8. Press START/ENTER.**

The stop time is calculated automatically.

**NOTE:** You can change the temperature and time settings any time after pressing START/ENTER by repeating Steps 3 through 8 unless the delay start time has been reached.

**PRESS**

START  
ENTER

**YOU SEE**



continued on next page

## USING THE TIMED OVEN CONTROL (contd.)

**9.** When the start time is reached:

The display will count down the baking/roasting time in hours and minutes (if the cook time is more than one hour) or in minutes and seconds (if the cook time is less than one hour).

**YOU SEE**



(display counts down cook time)

**10.** When cook time ends, the oven will automatically turn off. End and COOK TIME will show in the display. You will hear four tones then four 1-second repeater tones every minute.

**YOU SEE**



**11.** Press OFF/CANCEL to stop repeater tones and remove End from display and bring back the time of day.

**PRESS**

OFF  
CANCEL

**YOU SEE**



(time of day)

**NOTE:** You can do this step any time to cancel the Timed Oven control setting.

**To recall the programmed timed settings:**

Press the desired pad. The information will be displayed for 5 seconds.

To recall set:	Press:	You see for 5 seconds
Cook Time	COOK TIME*	set length of cook time
Delay Start	DELAY START	set delay start time
Temperature	BAKE	set temperature

\*If cook time has begun, when DELAY START is pressed, the display will show the time it started. When COOK TIME is pressed, the display will remove the seconds from the remaining countdown time.

**To change the programmed timed settings:**

To change set:	1. Press:	2. While setting is displayed, press:	3. Press:
Cook Time	COOK TIME	HOUR/MIN (▲) or (▼) keypads	START/ENTER
Delay Start*	DELAY START	HOUR/MIN (▲) or (▼) keypads	START/ENTER
Temperature	BAKE	TEMP (▲) or (▼) keypads	START/ENTER

\*You cannot change the set delay start time once it has been reached.



# USING THE WARM & READY WARMING DRAWER

## ⚠ WARNING

### Food Poisoning Hazard

Do not let food sit for more than one hour before or after cooking.

Doing so can result in food poisoning or sickness.

The Warm & Ready warming drawer is ideal for keeping hot cooked foods at serving temperature. It may also be used for warming breads and pastries. This feature, activated by the WARM & READY knob on the control panel, controls warming in the warming drawer, which is located below the oven. The rack can be used in two positions.

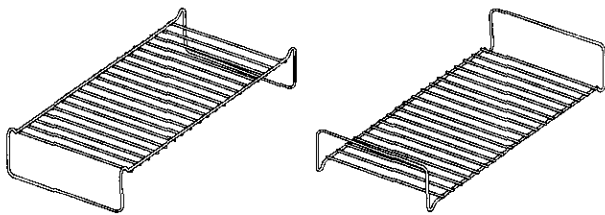

- For best results, hold most foods no longer than one hour. Hold smaller quantities and heat sensitive foods, such as eggs, no longer than 30 minutes.
- Food must be at serving temperature before being placed in the drawer.
- Different types of food can be placed in the warming drawer at the same time.
- Breads, pastries, and fruit pies may be warmed from room temperature on HI setting.
- Remove food from plastic bags and place in an oven-safe container.
- Cover foods with a lid or aluminum foil, not plastic wrap.
- Use only containers approved for oven use and follow manufacturer's instructions.
- Empty serving dishes and dinner plates can be heated while preheating the drawer.

### To use:

1. If using rack, position it where needed.
2. Turn the WARM & READY switch to choose HI, MED or LO settings.
3. Allow the drawer to preheat for ten minutes.

4. Place container with food in warming drawer.
5. When finished, turn knob to OFF.

### Choosing the right temperature

Food should be hot before being placed in the warming drawer. All foods should be covered except those marked with an asterisk (\*).

FOOD	SETTING
Bacon*	HI
Beef, medium and well done	HI
Bread, hard rolls	LO
Bread, soft rolls	LO
Casseroles	HI
Coffee cake, pastries	LO
Cooked Cereal	MED
Eggs	MED
Fish, Seafood (No Breading)	MED
Fish, Seafood (Breaded)*	MED
Fried Foods	HI
Gravy, Cream Sauces	HI
Ham	MED
Hor d'oeuvres (Soft)	HI
Hor d'oeuvres (Crisp)*	HI
Lamb	MED
Pancakes, waffles*	MED
Pies, custard	MED
Pies, single crust	LO
Pies, double crust	LO
Pizza	HI
Pork	MED
Potatoes, baked	HI
Potatoes, mashed	MED
Poultry	HI
Quiche	MED
Vegetables	MED

## USING THE WARM & READY WARMING DRAWER (contd.)

### To remove the warming drawer:

Remove all items from inside the warming drawer and allow the unit to cool completely before attempting to remove the drawer.

1. Pull drawer to its full open position.
2. Locate the black triangle tabs on each side of the drawer.

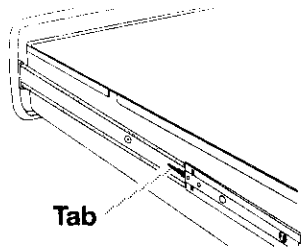

3. Press the tab DOWN on the RIGHT side and lift the tab UP on the LEFT side at the same time. Then pull drawer out another inch.

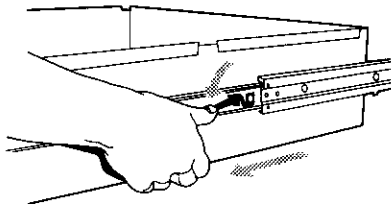

4. Carefully pull the drawer all the way out holding on to the sides, not the drawer front.

### To replace the warming drawer:

1. Align the drawer glides with the receiving guides.

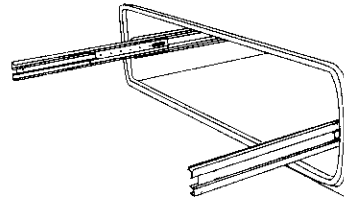

2. Push drawer in completely.
3. Gently open and close drawer to ensure it is seated properly on the slides.

## THE OVEN VENT

Hot air and moisture escape from the oven through a vent that is near the middle of the backguard. The vent lets air circulate properly. Be careful not to block the vent, or you will get poor baking/roasting results.

**NOTE:** Never store plastics, paper, or other items that could melt or burn near the oven vent, or any of the surface burners.

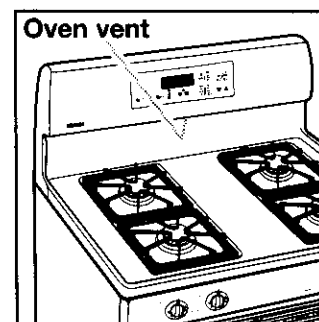

# Using the SELECT CLEAN™ Self-Cleaning Cycle



## ⚠ WARNING

### Burn Hazard

- Do not touch the oven during the Self-Cleaning cycle.
- Keep children away from oven during Self-Cleaning cycle.
- Do not use commercial oven cleaners in your oven.
- Failure to follow these instructions can result in burns, or illness from inhaling dangerous fumes.

## BEFORE YOU START

### NOTES:

- **Heat and odors are normal** during the Self-Cleaning cycle. Keep the kitchen well ventilated by opening a window or by turning on a vent hood or other kitchen vent during the cycle.
- **DO NOT** clean, move, or bend the gasket. You may get poor cleaning, baking, and roasting.
- The oven light will not work during the Self-Cleaning cycle.

### Before you start the Self-Cleaning cycle, make sure you:

- Hand-clean the areas shown. They do not get hot enough during the Self-Cleaning cycle for soil to burn away. Use hot water and detergent or a soapy, steel-wool pad for cleaning.
- Do not let water, cleaner, etc., enter slots on door and frame.
- Remove the broiler pan and grid and any cookware/bakeware being stored in the oven.
- Wipe out any loose soil or grease. This will help reduce smoke during the Self-Cleaning cycle.
- Wipe up food spills containing sugar and/or milk as soon as possible after the oven cools down. When sugar is heated to a high temperature in the Self-Cleaning cycle, the high temperature can cause the sugar to burn and react with the porcelain. This can cause staining and etching or pitting.
- Remove the oven racks from the oven if you want them to remain shiny. You can clean the oven racks in the Self-Cleaning cycle, but they will become harder to slide. (See the "Cleaning chart" in the "Caring for Your Range" section, p. 32.) If you clean the racks in the Self-Cleaning cycle, place them on the 2nd and 4th rack guides. (The guides are counted from bottom to top.)

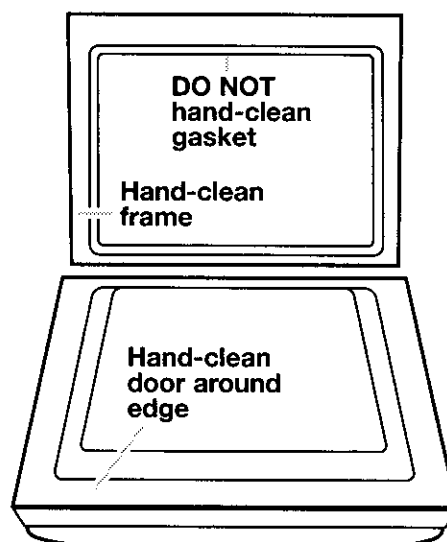

**IMPORTANT:** The health of some birds is extremely sensitive to the fumes given off during the Self-Cleaning cycle. Exposure to the fumes may result in death to certain birds. Always move birds to another closed and well ventilated room.

### TIPS:

- Keep the kitchen well ventilated during the Self-Cleaning cycle to help get rid of heat, odors, and smoke.
- Clean the oven before it gets heavily soiled. Cleaning a very soiled oven takes longer and results in more smoke than usual.
- Do not block the vent during the Self-Cleaning cycle. Air must move freely for best cleaning results.
- Do not leave plastic utensils on the cooktop. They may melt.
- Do not leave any foil in the oven during the Self-Cleaning cycle. Foil could burn or melt and damage the oven surface.

## HOW THE CYCLE WORKS

The SELECT CLEAN™ Self-Cleaning cycle uses temperatures much hotter than normal oven use to break up and burn away soil and grease. SELECT CLEAN will set the clean time automatically, once you choose the soil level. You can choose SoilL (light soil), SoilA (average soil) or SoilH (heavy soil). SoilL will clean for approximately 2-2½ hours, SoilA for 3-3½ hours and SoilH for 4-4½ hours.

The door must be closed completely for it to lock and the cycle to begin. If properly closed, the door will lock approximately 6 seconds after START/ENTER is pressed. The cycle time includes an approximate 30 minute cool down time. To see the time of day during the cycle, press CLOCK for 5 seconds.

## SETTING THE CONTROLS

To start Self-Cleaning immediately:

**1. Press SELECT CLEAN.**

Press pad twice, SoilA (for average soil) will replace SoilL.

Press pad three times, SoilH (for heavy soil) will replace SoilA.

**NOTE:** You can scroll through all 3 settings (SoilL, SoilA and SoilH) continuously by pressing SELECT CLEAN.

PRESS



YOU SEE



(example shows light soil setting)

**2. Press START/ENTER.**

PRESS



YOU SEE



**3. After the SELECT CLEAN Self-Cleaning cycle ends:**  
LOCKED goes off and the door unlocks.

YOU SEE



**4. Press any pad to remove "End" and bring back time of day; or open door, at which time "door" will be displayed. Then close door and time of day will appear in display window.**

YOU SEE



(when pressing any pad)

YOU SEE



(when opening the door)

## SETTING THE CONTROLS (contd.)

5. After the oven is cool, wipe off any residue or ash with a damp cloth or sponge. If needed, touch up spots with a mild abrasive cleanser or cleaning sponge.

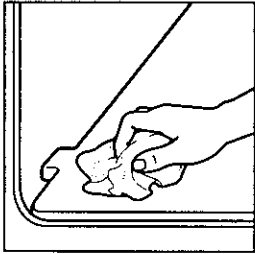

To delay start the Self-Cleaning cycle:

**NOTE:** Make sure the clock is set to the correct time of day. (See "Setting the clock" in the "Using Your Range" section, p. 12.)

1. Press SELECT CLEAN.

Press pad twice, SoilA (for average soil) will replace SoilL.

Press pad three times, SoilH (for heavy soil) will replace SoilA.

**NOTE:** You can scroll through all 3 settings (SoilL, SoilA and SoilH) continuously by pressing SELECT CLEAN.

PRESS



YOU SEE



(example shows light soil setting)

2. Press DELAY START.

PRESS

DELAY  
START

YOU SEE



3. Set the start time.

Press the HOUR/MIN (▲) or (▼) pad(s) until the correct time of day to start the SELECT CLEAN Self-Cleaning cycle shows on the display.

PRESS

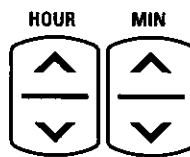

YOU SEE



(example for 12:30 start time)

4. Press START/ENTER.

PRESS

START  
ENTER

YOU SEE



5. Once Delay Start time has been reached, the oven begins the SELECT CLEAN™ Self-Cleaning cycle.

YOU SEE



(example shows light soil setting)

## SETTING THE CONTROLS (contd.)

6. After the SELECT CLEAN Self-Cleaning cycle ends:  
LOCKED goes off and the door unlocks.

YOU SEE



7. Press any pad to remove "End" and bring back time of day; or open door, at which time "door" will be displayed. Then close door and time of day will appear in display window.

YOU SEE



(when pressing any pad)

YOU SEE



(when opening the door)

8. After the oven cools to room temperature, wipe off any residue or ash with a damp cloth or sponge. If needed, touch up spots with a mild abrasive cleanser or cleaning sponge.

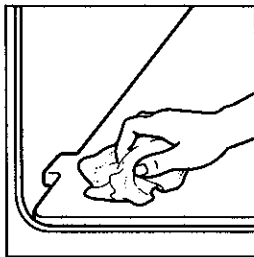

To stop the SELECT CLEAN Self-Cleaning cycle at any time:

Press OFF/CANCEL.

PRESS

OFF  
CANCEL

YOU SEE



If the oven temperature is too high for you to immediately open the door when you press OFF/CANCEL, "cln," ON, "cool," and LOCKED will appear on the display until the oven cools; then "End" will appear and the door will unlock.



# Caring for Your Range

## CLEANING CHART

Before cleaning, always make sure all controls are off and the range is cool. Refer to instructions on all cleaning products before using them to clean your range.

PART	CLEANING METHOD	SPECIAL INSTRUCTIONS
<b>Control knobs</b>	<ul style="list-style-type: none"> <li>• Soap and water</li> <li>• Dishwasher</li> </ul>	<ul style="list-style-type: none"> <li>• DO NOT use steel wool or abrasive cleaners.</li> <li>• Pull knobs straight away from control panel.</li> <li>• Wash, rinse and dry with soft cloth.</li> </ul>
<b>Control panel</b>	<ul style="list-style-type: none"> <li>• Soap and water</li> <li>• Spray glass cleaner</li> </ul>	<ul style="list-style-type: none"> <li>• Wash, rinse and dry with soft cloth.</li> <li>• Apply spray cleaner to paper towel; do not spray directly on panel.</li> </ul>
<b>Exterior surfaces*</b> (excluding control panel and oven door glass)	<ul style="list-style-type: none"> <li>• Soap and water</li> <li>• Mild liquid cleaner</li> <li>• Spray glass cleaner</li> <li>• Non-abrasive plastic scrubbing pad</li> </ul>	<ul style="list-style-type: none"> <li>• DO NOT use abrasive or harsh cleaners like chlorine bleach, ammonia or oven cleaners.</li> <li>• Wash, rinse and dry with soft cloth.</li> <li>• Gently clean around the model and serial plate, too much scrubbing could remove the numbers.</li> <li>• <b>NOTE:</b> To avoid product damage, do not remove the cooktop.</li> </ul>
<b>Porcelain-coated cooktop grates and surface burner caps*</b> <ul style="list-style-type: none"> <li>• Light to moderate soil</li> <li>• Heavy burned-on soils</li> </ul>	<ul style="list-style-type: none"> <li>• Sears Grate Cleaner</li> <li>• Soap and water</li> <li>• Non-abrasive plastic scrubbing pad</li> <li>• Dishwasher (grates only)</li> <li>• Non-abrasive plastic scrubbing pad</li> <li>• Mild abrasive powdered cleanser and water</li> </ul>	<ul style="list-style-type: none"> <li>• Clean as soon as they become dirty.</li> <li>• Wash, rinse and dry well.</li> <li>• Run dishwasher with only grates loaded on the lower rack using the most aggressive cycle.</li> <li>• Repeat steps of cleaning process (with items at left) as needed, until soil is completely removed.</li> <li>• Rinse thoroughly and dry.</li> <li>• <b>NOTE:</b> Do not reassemble caps on burners while wet. Do not wash caps in dishwasher.</li> </ul>

\*When the cooktop is cool, remove all spills and clean. Food spills containing acids, such as vinegar and tomato, may affect the finish. To avoid porcelain grate chipping, do not bang grates and caps against each other or other hard surfaces such as cast iron cookware.

continued on next page

## CLEANING CHART (contd.)

PART	CLEANING METHOD	SPECIAL INSTRUCTIONS
<b>Surface burners</b>		<ul style="list-style-type: none"> <li>• See "Sealed surface burners and cooktop" in the "Caring for Your Range" section, p. 33.</li> </ul>
<b>Oven door glass</b>	<ul style="list-style-type: none"> <li>• Soap and water</li> <li>• Non-abrasive plastic scrubbing pad</li> <li>• Spray glass cleaner</li> </ul>	<ul style="list-style-type: none"> <li>• Wash, rinse and dry with soft cloth.</li> <li>• Wipe with paper towel.</li> </ul>
<b>Oven cavity</b> <ul style="list-style-type: none"> <li>• Food spills containing sugar and/or milk</li> <li>• All other spills</li> </ul>	<ul style="list-style-type: none"> <li>• Soap and water</li> <li>• Self-cleaning cycle</li> </ul>	<ul style="list-style-type: none"> <li>• When oven cools, wash, rinse and dry with soft cloth.</li> <li>• See "Using the SELECT CLEAN™ Self-Cleaning Cycle," p. 27.</li> </ul>
<b>Oven racks</b>	<ul style="list-style-type: none"> <li>• Soap and water</li> <li>• Steel wool pad</li> <li>• Self-cleaning cycle</li> </ul>	<ul style="list-style-type: none"> <li>• Wash, rinse and dry.</li> <li>• Place on 2nd and 4th rack guides. <b>Racks will discolor and become harder to slide.</b> After cleaning, apply vegetable oil to rack guides for easier sliding.</li> </ul>
<b>Broiler pan and grid</b>	<ul style="list-style-type: none"> <li>• Soap and water</li> <li>• Steel wool pad</li> <li>• Dishwasher</li> <li>• Solution of 1/2 cup ammonia to 1 gallon water</li> <li>• Mild abrasive cleanser or commercial oven cleaner</li> </ul>	<ul style="list-style-type: none"> <li>• Wash, rinse and dry.</li> <li>• Soak for 20 minutes, then scrub with plastic scrubbing pad.</li> <li>• <b>DO NOT</b> clean the pan and grid in the self-cleaning cycle.</li> </ul>
<b>Warming drawer cavity</b> <ul style="list-style-type: none"> <li>• Food spills containing sugar and/or milk</li> <li>• All other spills</li> </ul>	<ul style="list-style-type: none"> <li>• Soap and water</li> <li>• Mild detergent</li> </ul>	<ul style="list-style-type: none"> <li>• When drawer cools, wash, rinse and dry with soft cloth.</li> <li>• Wash, rinse and dry with soft cloth.</li> </ul>



# SEALED SURFACE BURNERS AND COOKTOP

## Cleaning the surface burners

- You should routinely remove and clean the burner cap. Always clean the burner cap after a spill-over. Keeping the burner cap clean prevents poor ignition and an uneven flame.
- For the proper flow of gas and ignition of the burner, **do not allow spills, food, cleaning agents, or any other material to enter the gas tube opening or burner ports.**
- Gas must flow freely through the gas tube opening for the burner to light properly. Keep this area free of any soil and protect it from boilovers or spillovers. **Always** keep the burner cap in place whenever a surface burner is in use.
- Let the cooktop cool before cleaning.
- Do not use oven cleaners, bleach, or rust removers.
- Do not obstruct the flow of combustion and ventilation air around the burner grate edges.
- Occasionally check the burner flames for proper size and shape as shown.

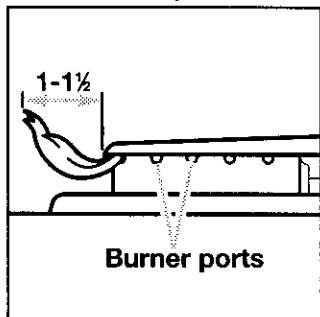

A good flame is blue in color not yellow. If the flames are not burning at all ports, you may need to clean the burner ports.

Cast-iron burner cap

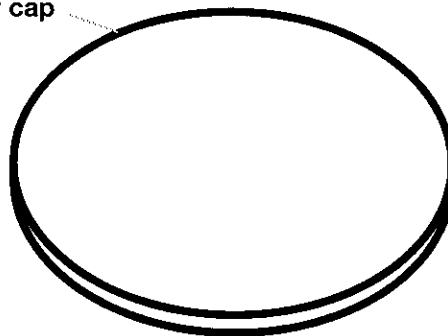

Alignment pins

Ignitor

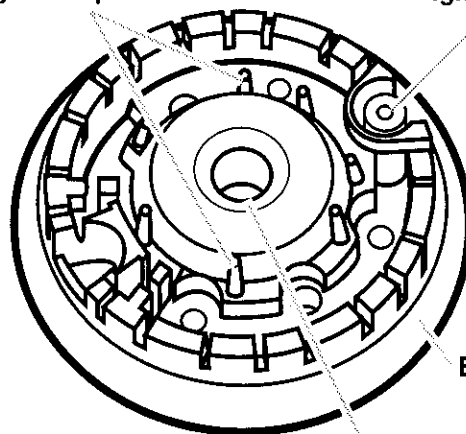

Burner base

Gas tube opening

## SEALED SURFACE BURNERS AND COOKTOP (contd.)

### To clean the burners:

1. Remove the burner cap from the burner base.
2. Clean the burner cap with warm, soapy water and a sponge. You can also clean it with a mildly abrasive scrubbing pad or cleanser. Do not clean the burner cap in a dishwasher or self-cleaning oven.
3. If the gas tube opening has become soiled or clogged, use a damp cloth to clean the area.
4. If the burner ports are clogged, clean them with a straight pin. Do not enlarge or distort the port. Do not use a wooden toothpick. If the burner needs to be adjusted, call a qualified technician for service.

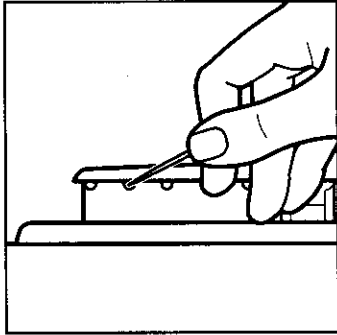

Do not enlarge or distort the port. Do not use a wooden toothpick. If the burner needs to be adjusted, call a qualified technician for service.

5. After cleaning the gas tube opening and ports, replace the burner cap. To replace the burner cap, make sure the alignment pins on the cap are properly aligned with the burner base.

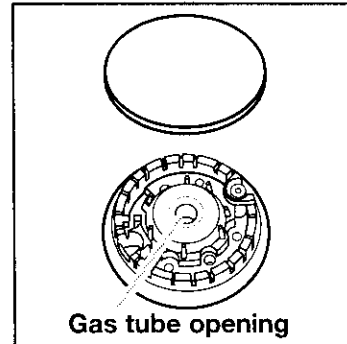

replace the burner cap. To replace the burner cap, make sure the alignment pins on the cap are properly aligned with the burner base.

6. Turn on the burner to see if it will light. If the burner does not light after you have cleaned it, recheck cap alignment or contact a Sears Service Center. Do not service the sealed burner yourself.

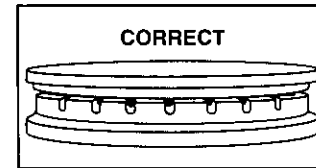
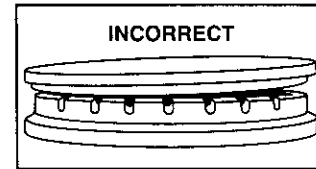

If the burner does not light after you have cleaned it, recheck cap alignment or contact a Sears Service Center. Do not service the sealed burner yourself.

## REMOVING THE OVEN DOOR

For normal use of your range, you do not need to remove the door. However, if you find it necessary to remove the door, follow the instructions in this section.

**NOTE:** The oven door is heavy.

### Before removing the door:

1. Use a putty knife or screwdriver and insert it at the bottom corner of the door stop clip.
2. Pry door stop clip free and remove from front frame hinge slot. Take care not to scratch porcelain.
3. Repeat procedure for other door stop clip.

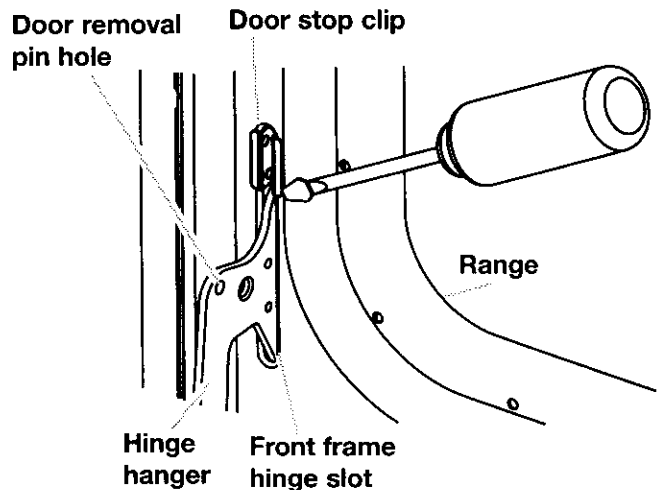

## REMOVING THE OVEN DOOR (contd.)

### To remove:

1. Open the oven door. Insert door removal pins, included with your range, into both hinge hangers. **Do not remove the pins while the door is removed from the range.**

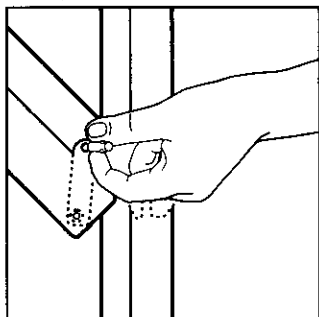

3. Grasp the door on the sides with your fingers on the front of the door and your thumbs on the inside surface.

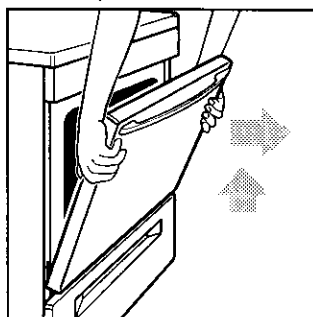

2. Carefully close the door until it rests against the door removal pins.

4. Pull door straight up, then toward you. Hinge hangers will slide out of front frame hinge slot.

### To replace:

**NOTE:** The door removal pins you inserted must still be in both door hinges.

1. Grasp the door on the sides with your fingers on the front of the door and your thumbs on the inside surface.

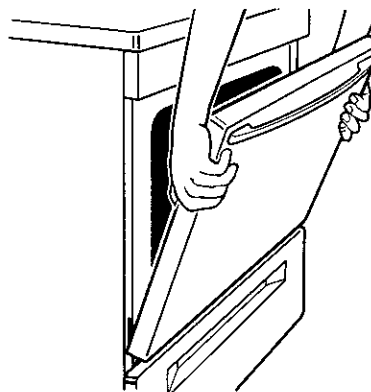

continued on next page

## REMOVING THE OVEN DOOR (contd.)

2. Hold oven door so that the top edge of each hinge hanger is horizontal. Insert hinge hangers into the front frame hinge slots.
3. Tilt top of door toward range. Slide hinge hangers down onto front frame support pins.

**NOTE:** Make sure the hinge hangers are fully seated and engaged on the support pins.

4. Insert the door stop clip with the angular surface at the top of the frame hinge slot, then push in the bottom of the clip until flanges are flush with the front frame.
5. Open the door completely and remove the door removal pins. Save door removal pins for future use.
6. Close the door.
7. Check for alignment to make sure door is installed evenly.

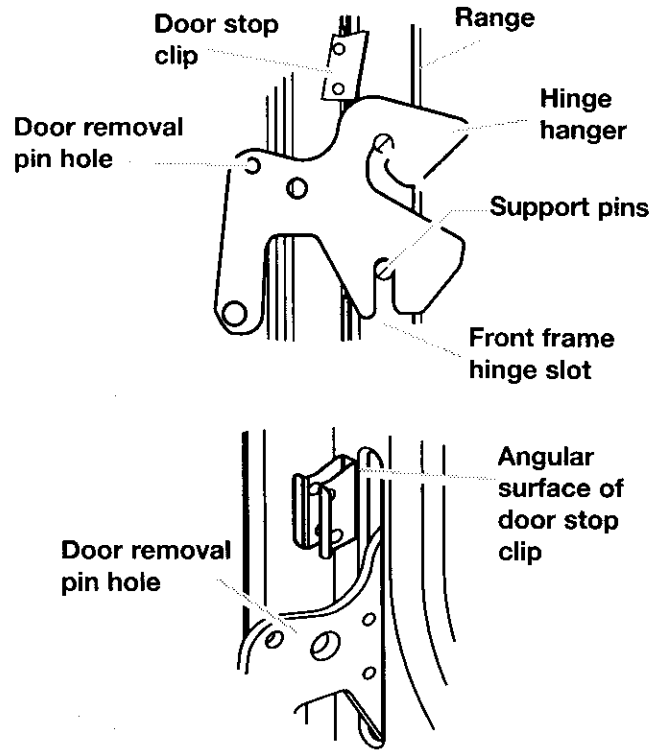

## THE OVEN LIGHT

The oven light will come on when you open the oven door. The oven light will not work during the Self-Cleaning cycle.

To turn the light on or off when the oven door is closed:

- Press the OVEN pad.



To replace the oven light:

1. Unplug range or disconnect power.
2. Remove the glass bulb cover in the back of the oven by turning it counterclockwise.

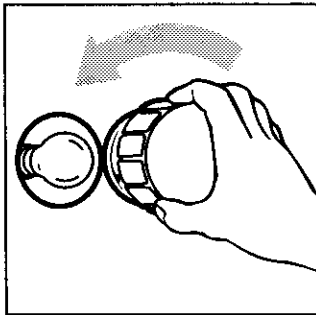

3. Remove the light bulb from its socket by turning it counterclockwise. Replace the bulb with a 40-watt appliance bulb.

4. Replace the light bulb cover by turning it clockwise.

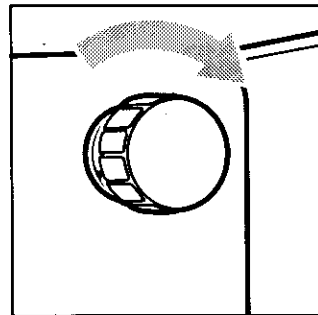

5. Plug in range or reconnect power.

# Troubleshooting

Most cooking problems are caused by little things you can find and fix without tools of any kind. Check the lists below and on the next page before calling for assistance or service.

## RANGE DOES NOT WORK

PROBLEM	CAUSE/SOLUTION
Nothing works	<ul style="list-style-type: none"><li>● The range is not plugged into a properly wired and polarized outlet. Try another outlet to check for proper wiring and polarity.</li><li>● The range is not plugged into a properly grounded 3 prong outlet (120v polarized).</li><li>● The range is not properly connected to the gas supply. Contact a Sears Service Center to reconnect the range to the gas supply. (See the Installation Instructions.)</li><li>● A household fuse has blown or a circuit breaker has been tripped.</li><li>● The Oven and Cooktop Lockouts have been set.</li></ul>

## OVEN/BROILER BURNER

PROBLEM	CAUSE/SOLUTION
The oven does not work	<ul style="list-style-type: none"><li>● The range is not plugged into a properly wired and polarized outlet. Try another outlet to check for proper wiring and polarity.</li><li>● When using the oven for the first time, it is necessary to light the surface burners first, to purge air from the gas lines.</li><li>● The electronic control is not set correctly. Refer to setting the electronic oven control section. (See pp. 11-24.)</li><li>● A delay start has been set. Wait for the start time to be reached or cancel and reset the control.</li><li>● The main or regulator gas shutoff valve is in the off position. (See the Installation Instructions.)</li><li>● The Oven Lockout has been set.</li></ul>
Burner makes muffled ticking noise when in use	<ul style="list-style-type: none"><li>● This is normal. This sound occurs when the oven burner cycles on and off to hold the set oven temperature.</li></ul>
The burner fails to light	<ul style="list-style-type: none"><li>● The ignition system is broken. Contact a Sears Service Center to replace it.</li><li>● A household fuse has blown or a circuit breaker has been tripped.</li></ul>
The burner flames lift away from the ports, are yellow, or are noisy	<ul style="list-style-type: none"><li>● The air/gas mixture is incorrect. Contact a Sears Service Center to check the air/gas mixture or see the Installation Instructions.</li></ul>
Oven burner lights then goes out after 1 minute	<ul style="list-style-type: none"><li>● Press OFF/CANCEL, then wait 1 minute before trying again. The range is not plugged into a properly wired and polarized outlet. Try another outlet to check for proper wiring and polarity.</li></ul>

ENGLEIGH

## SURFACE BURNERS

PROBLEM	CAUSE/SOLUTION
The burner fails to light	<ul style="list-style-type: none"> <li>● The range is not plugged into a properly wired and polarized outlet. Try another outlet to check for proper wiring and polarity.</li> <li>● When using the surface burners for the first time, it is necessary to turn on any one of the surface burner knobs to release air from the gas lines.</li> <li>● The control knob is not set correctly. Push in the control knobs before turning them. Make sure the control knob is turned to the LITE position. (See p. 7.)</li> <li>● A household fuse has blown or a circuit breaker has been tripped.</li> <li>● The burner ports may be clogged. Clean them with a straight pin. (See p. 34.)</li> <li>● Make sure Cooktop Lockout has been cancelled. (See p. 13.)</li> <li>● There is a power outage.</li> </ul>
The burner flames are uneven	<ul style="list-style-type: none"> <li>● The burner ports may be clogged. Clean them with a straight pin. (See p. 34.)</li> <li>● The burner caps may not be positioned properly. (See p. 34.)</li> </ul>
The burner flames lift off the ports, are yellow, or are noisy when turned off	<ul style="list-style-type: none"> <li>● The burner needs cleaning. (See pp. 33, 34.)</li> <li>● The burner may be damaged. Contact a Sears Service Center to check the burner.</li> <li>● If propane gas is being used, the range may have been converted improperly. Contact a Sears Service Center.</li> </ul>
The burner makes a popping noise when on	<ul style="list-style-type: none"> <li>● The burner is wet from washing. Let it dry.</li> </ul>

## WHEN SELF-CLEANING YOUR OVEN

PROBLEM	CAUSE/SOLUTION
The Self-Cleaning cycle will not work	<ul style="list-style-type: none"> <li>● START/ENTER has not been pressed.</li> <li>● A delay start has been set. Wait for the start time to be reached or cancel and reset the control.</li> <li>● The door is not closed all the way.</li> </ul>

## COOKING RESULTS

PROBLEM	CAUSE/SOLUTION
Cookware not level on cooktop (Check to see if liquids are level in cookware)	<ul style="list-style-type: none"> <li>● Level the range. (See the Installation Instructions.)</li> <li>● Use cookware with a flat bottom.</li> </ul>
Excessive heat on cooktop in areas around cookware	<ul style="list-style-type: none"> <li>● Choose cookware the same size or slightly larger than the burner flame.</li> </ul>
The oven temperature seems too low or too high	<ul style="list-style-type: none"> <li>● Adjust the oven temperature control. (See "Readjusting the oven temperature control," p. 17.)</li> </ul>
Slow baking or roasting	<ul style="list-style-type: none"> <li>● Increase baking or roasting time.</li> <li>● Increase temperature 25°F.</li> <li>● Preheat to selected temperature before placing food in oven when preheating is recommended.</li> <li>● Choose bakeware that will allow 2 inches of air space around all sides.</li> <li>● Open oven door to check food when timer signals shortest time suggested in recipe.</li> <li>● Oven peeking can make cooking times longer.</li> </ul>
Baked items too brown on bottom	<ul style="list-style-type: none"> <li>● Preheat oven to selected temperature before placing food in oven.</li> <li>● Choose bakeware that will allow 2 inches of air space around all sides.</li> <li>● Position rack higher in oven.</li> <li>● Decrease oven temperature 15° to 25°F.</li> </ul>
Unevenly baked items	<ul style="list-style-type: none"> <li>● Level the range.</li> <li>● Bake in center of oven with 2 inches of space around each pan.</li> <li>● Check to make sure batter is level in pan.</li> </ul>
Crust edge browns before pie is done	<ul style="list-style-type: none"> <li>● Shield edge with foil.</li> </ul>

## DISPLAY MESSAGES

PROBLEM	CAUSE/SOLUTION
The display is showing "PF" and 	<ul style="list-style-type: none"> <li>● There has been a power failure. Press OFF/CANCEL to clear the display, then reset the clock. (See p. 12.)</li> <li>● The Cooktop Lockout feature is engaged. To unlock the surface burners, see "Using the Cooktop Lockout," p. 13.</li> </ul>
"F" followed by a number shows on the display	<ul style="list-style-type: none"> <li>● Press OFF/CANCEL to clear the display. If an "F" code appears again, call for service.</li> </ul>
"EO F5" appears on the display (The oven door will not close because the self-clean latch mechanism interferes.)	<ul style="list-style-type: none"> <li>● Press OFF/CANCEL to clear display.</li> <li>● Depress and hold the door switch plunger (located on the oven front frame). Latch mechanism will unlock in about 6 seconds.</li> </ul>

# Index

TOPIC	PAGE	TOPIC	PAGE
ANTI-TIP BRACKET .....	4	OVEN VENT .....	26
BROILING		PANS .....	8, 9
Grid .....	19, 20	PARTS .....	6
Guidelines .....	19, 20	ROASTING	
Pan .....	18-20	Pans .....	9
Setting cycle.....	18	Setting cycle.....	15
Oven rack positions .....	20	Oven rack positions .....	9
CLEANING		Tips.....	16
Broiler pan and grid .....	32	SAFETY .....	4, 5
Control knobs.....	31	SELECT CLEAN™ SELF-CLEANING CYCLE	
Control panel .....	31	Before you start .....	27
Exterior surfaces .....	31	Delay start .....	29
Oven cavity .....	32	How the cycle works .....	28
Oven door glass.....	32	Setting the controls .....	28
Oven racks.....	32	Starting immediately .....	28
Self-Cleaning .....	27-30	Stopping the cycle .....	30
Surface burners .....	33, 34	SERVICE .....	Back Cover
Cooktop grates and surface burner caps .....	31	STURDIGLIDE™ HALF-RACK WITH REMOVABLE INSERT....	9
Warming drawer cavity .....	32	STURDIGLIDE™ RACK WITH INTEGRATED HANDLE.....	9
CONTROL PANEL		SURFACE BURNERS	
Burner heat settings.....	7	Control knobs.....	6, 31
Control knobs.....	6, 7	Control setting guide .....	7
Surface burner markers .....	6	Power Burner .....	7
COOKWARE		SURESIMMER™ setting .....	7
Canning .....	8	Surface burner markers .....	6
Materials.....	8	Tips.....	7
ELECTRONIC OVEN CONTROL		TIMED OVEN CONTROL .....	21-24
12-hour shut-off .....	13	TROUBLESHOOTING .....	37-39
Canceling .....	15	ULTRABAKE™ BAKING	
Celsius/Fahrenheit .....	17	Aluminum foil .....	10
Clock .....	12	Bakeware .....	10
Cooktop Lockout .....	13	Pans .....	9
Display/clock .....	11	Preheat conditioning .....	16
Kitchen timer .....	14	Setting cycle.....	15
Oven Lockout.....	12	Oven rack positions .....	9
Starting.....	15	Tips.....	16
Tones .....	13	ULTRABAKE system .....	15, 16
FEATURES .....	6	WARM & READY WARMING DRAWER.....	25, 26
MODEL AND SERIAL NUMBER .....	2	WARRANTY .....	3
OVEN DOOR .....	34-36		
OVEN LIGHT .....	36		
OVEN TEMPERATURE			
Readjusting .....	17		
Setting .....	15, 19		



# Get it fixed, at your home or ours!

For repair of major brand appliances **in your own home...**  
no matter who made it, no matter who sold it!

**1-800-4-MY-HOME<sup>SM</sup>** Anytime, day or night  
(1-800-469-4663)

[www.sears.com](http://www.sears.com)

To bring in products such as vacuums, lawn equipment and electronics  
for repair, call for the location of your nearest **Sears Parts & Repair Center**

**1-800-488-1222** Anytime, day or night

[www.sears.com](http://www.sears.com)

For the replacement parts, accessories and owner's manuals  
that you need to do-it-yourself, call **Sears PartsDirect<sup>SM</sup>**!

**1-800-366-PART** 6 a.m. – 11 p.m. CST,  
(1-800-366-7278) 7 days a week

[www.sears.com/partsdirect](http://www.sears.com/partsdirect)

To purchase or inquire about a Sears Service Agreement:

**1-800-827-6655**

7 a.m. – 5 p.m. CST, Mon. – Sat.

Para pedir servicio de reparación a domicilio,  
y para ordenar piezas con entrega a domicilio:

**1-888-SU-HOGAR<sup>SM</sup>**  
(1-888-784-6427)

Au Canada pour service en français:

**1-877-LE-FOYER<sup>SM</sup>**  
(1-877-533-6937)

