

Installation Instructions

	! WARNING
	<ul style="list-style-type: none">• ALL RANGES CAN TIP• INJURY TO PERSONS COULD RESULT• INSTALL ANTI-TIP DEVICE PACKED WITH RANGE• SEE INSTALLATION INSTRUCTIONS

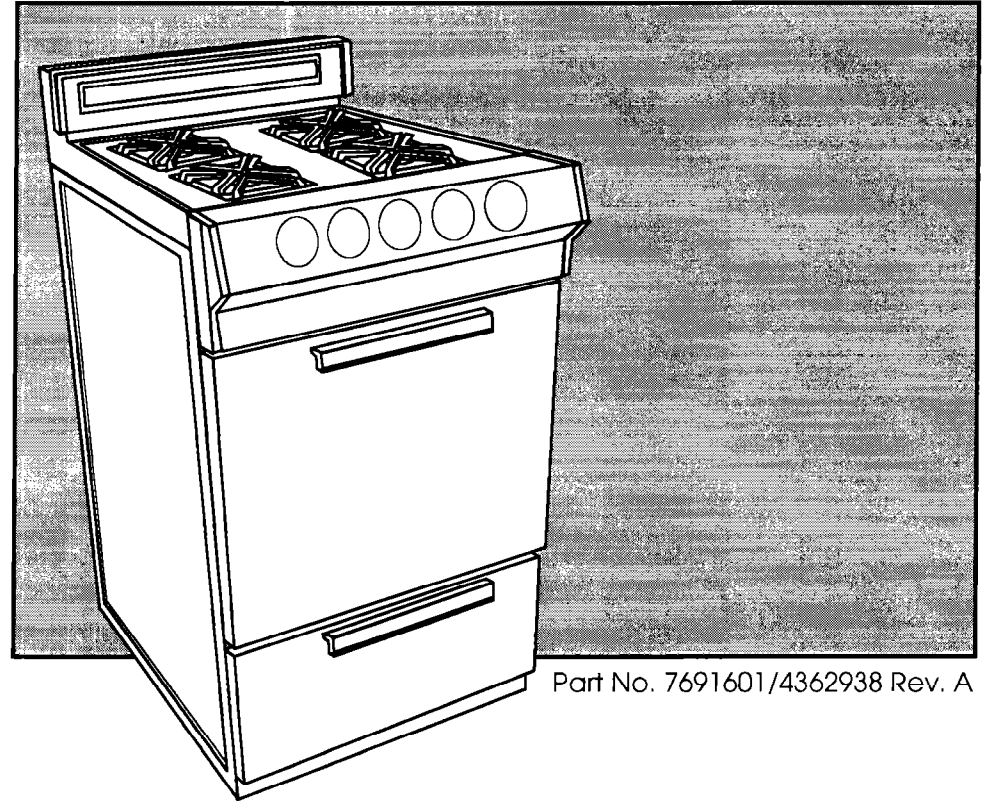

Part No. 7691601/4362938 Rev. A

IMPORTANT:
Read and save
these instructions.

IMPORTANT:

Installer: Leave Installation Instructions with the homeowner.

Homeowner: Keep Installation Instructions for future reference.

Save Installation Instructions for local electrical inspector's use.

**20" Freestanding
Gas Range**

Before you start...

Proper installation is your responsibility. Make sure you have everything necessary for correct installation. It is the responsibility of the installer to comply with the installation clearances specified on the serial/rating plate. The serial/rating plate is located under the maintop.

Check location where range will be installed. The range should be located away from strong draft areas, such as windows, doors and strong heating vents or fans. The range should be located for convenient use in the kitchen. Recessed installation must provide complete enclosure of the sides and rear of range.

Cabinet opening dimensions

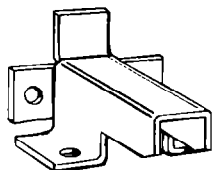
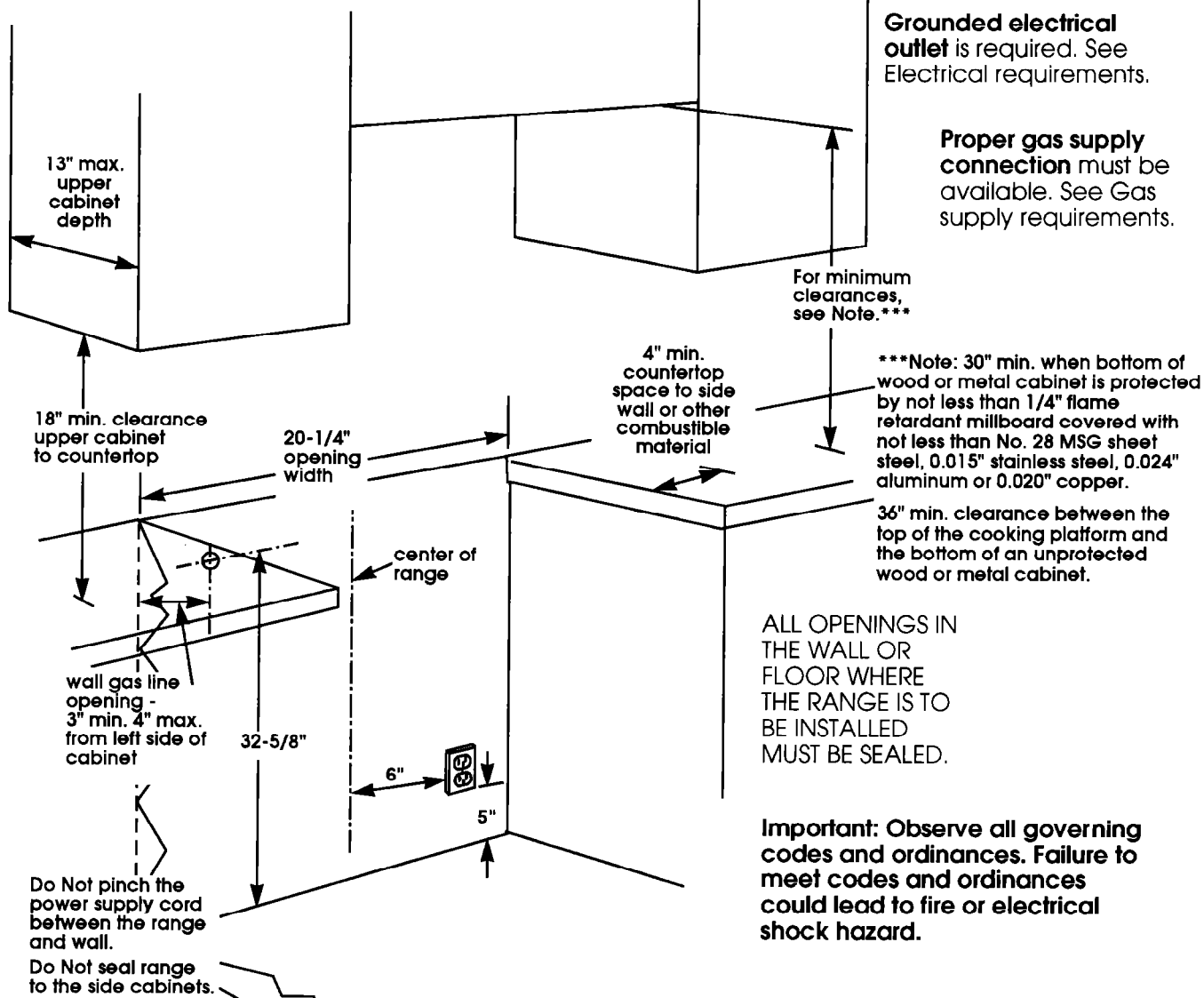

The anti-tip bracket must be installed. For detailed instructions, see Panel C.

Product dimensions

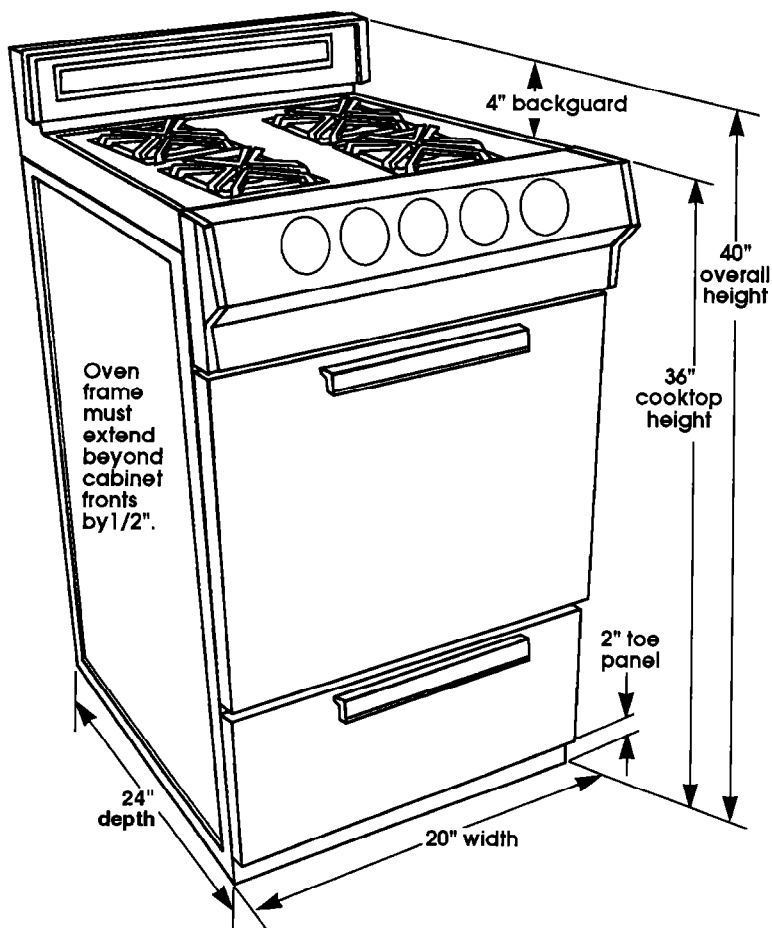

Panel A

WARNING: If the information in this manual is not followed exactly, a fire or explosion may result causing property damage, personal injury or death.

- Do Not store or use gasoline or other flammable vapors and liquids in the vicinity of this or any other appliance.
- **WHAT TO DO IF YOU SMELL GAS**
 - Do Not try to light any appliance.
 - Do Not touch any electrical switch; Do Not use any phone in your building.
 - Immediately call your gas supplier from a neighbor's phone. Follow gas supplier's instructions.
 - If you cannot reach your gas supplier, call the fire department.
- Installation and service must be performed by a qualified installer, service agency or the gas supplier.

WARNING

Fire Hazard

Do Not obstruct the flow of combustion and ventilation air.

Personal Injury Hazard

To eliminate the risk of burns or fire, avoid installing cabinet storage above the cooking surface. If cabinets are already installed, reduce the hazard of reaching over a heated cooking surface by installing a range hood. The range hood should extend a minimum of 5 inches out from the bottom front of the cabinets.

Reaching over a heated cooking surface could result in a serious burn or other personal injury.

Electrical Shock Hazard

It is the customer's responsibility:

- To contact a qualified electrical installer.
- To assure that electrical installation is adequate and in conformance with National Electrical Code, ANSI/NFPA 70 — latest edition,* and all local codes and ordinances.

Failure to do so could result in fire, electrical shock or other personal injury.

WARNING

Electrical Shock Hazard

- Take special care when cutting holes in wall. Electrical wires may be concealed behind the wall covering and contact with them could result in electrical shock.
- Locate any electrical circuits that could be affected by the installation of this product and disconnect power circuit.

Failure to do so could result in fire or electrical shock.

Mobile home installation

The installation of this range must conform to the Manufactured Home Construction and Safety Standards, Title 24 CFR, Part 3280 (formerly the Federal Standard for Mobile Home Construction and Safety, Title 24, HUD Part 280) or when such standard is not applicable, the Standard for Manufactured Home Installation 1982 (Manufactured Home Sites, Communities and Setups), ANSI A225.1/NFPA 501A — 1987 or latest edition, or with local codes.

When this range is installed in a mobile home, it must be secured to the floor during transit. Any method of securing the range is adequate as long as it conforms to the standards listed above. Copies of the standards listed may be obtained from:

*National Fire Protection Association
Batterymarch Park
Quincy, Massachusetts 02269

**American Gas Association
1515 Wilson Boulevard
Arlington, Virginia 22209

CAUTION

Property Damage

- Contact a qualified floor covering installer to check that the floor covering can withstand heat at least 90°F above room temperature.
- Use an insulated pad or 1/4" plywood under range if installing range over carpeting.

Failure to do so may result in damage to floor covering.

Tools and materials needed for installation:

- hand or electric drill
- concrete/ceramic floors: 1/4" masonry drill bit
- wood floors: 1/8" drill bit
- gas line shutoff valve
- L.P.-resistant pipe-joint compound
- A.G.A. design-certified flexible metal connector (4-5 feet)

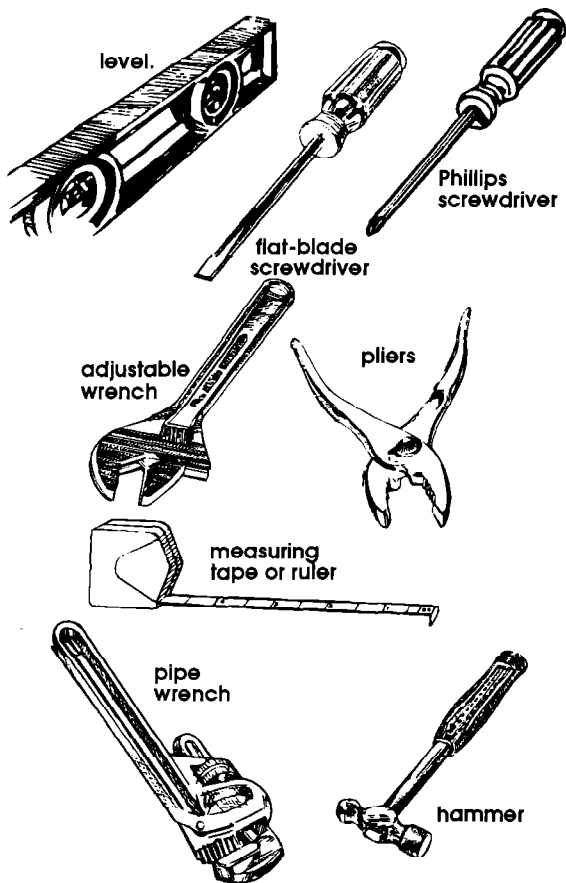

Gas supply requirements

Observe all governing codes and ordinances.

WARNING

Fire Hazard

- Range must be connected to a regulated gas supply.
- L.P. gas supply must Not exceed a pressure of 14" water column. This must be checked by a qualified technician before installing this range.
- Do Not use an open flame to test for leaks from gas connections.
- New, A.G.A. design-certified flexible gas line should be used when local codes permit.

Failure to follow these instructions could result in a fire, explosion or personal injury.

A.

This installation must conform with local codes and ordinances. In the absence of local codes, installations must conform with American National Standard, National Fuel Gas Code ANSI Z223.1 — latest edition**.

B.

Input ratings shown on the serial/rating plate are for elevations up to 2,000 feet. For elevations above 2,000 feet, ratings are reduced at a rate of 4% for each 1,000 feet above sea level.

C.

This range is equipped for use with NATURAL gas. It is design-certified by A.G.A. for NATURAL and L.P. gases with appropriate conversion. The serial/rating plate, located under the maintop, has information on the type of gas that can be used. If this information does not agree with the type of gas available, check with the local gas supplier. See Panel E for L.P. gas conversion instructions.

D.

Provide a gas supply line of 3/4" rigid pipe to the range location. A smaller size pipe on long runs may result in insufficient gas supply. Pipe-joint compounds made for use with L.P. gas must be used. With L.P. gas, piping or tubing size can be 1/2" minimum. L.P. gas suppliers usually determine the size and materials used on the system.



E.

If local codes permit, a new, A.G.A. design-certified, 4-5 foot long, 1/2" or 3/4" I.D., flexible metal appliance connector is recommended for connecting this range to the gas supply line. Do Not kink or damage the flexible connector when moving the range. A 1/2" male pipe thread is needed for connection to pressure regulator female pipe threads.

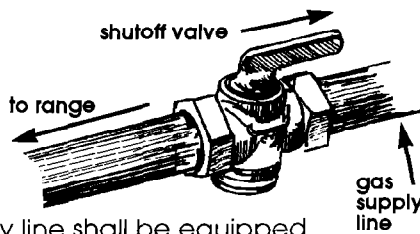

F.

The supply line shall be equipped with an approved shutoff valve. This valve should be located in the same room as the range and should be in a location that allows ease of opening and closing. Do Not block access to shutoff valve.



G.

If rigid pipe is used as a gas supply line, a combination of pipe fittings must be used to obtain an in-line connection to the range. All strains must be removed from the supply and fuel lines so range will be level and in line.

H.

The inlet pressure to the regulator should be as follows for both operation and checking regulator setting:

NATURAL GAS:

Set pressure 6 inches
Maximum inlet pressure 14 inches

L.P. GAS:

Set pressure 11 inches
Maximum inlet pressure 14 inches

I.

Line pressure testing:

Testing above 1/2 psi (gauge)

The range and its individual shutoff valve must be disconnected from the gas supply piping system by closing its individual manual shutoff valve during any pressure testing of the gas supply piping system at test pressures equal to or greater than 1/2 psig (3.5 kPa).

Testing at 1/2 psi (gauge)

The range must be isolated from the gas supply piping system by closing its individual manual shutoff valve during any pressure testing of the gas supply piping system at test pressures equal to or less than 1/2 psig (3.5 kPa).

Electrical requirements

WARNING

Shock Hazard

- Electrical ground is required on this appliance.
- Do Not ground to a gas pipe.
- Do Not modify the power supply cord plug. If it does not fit the outlet, have a proper outlet installed by a qualified electrician.
- Do Not have a fuse in the neutral or grounding circuit. A fuse in the neutral or grounding circuit could result in electrical shock.
- Do Not use an extension cord with this appliance.
- Check with a qualified electrician if you are in doubt as to whether the appliance is properly grounded.

Failure to follow these instructions could result in serious injury or death.

If codes permit and a separate grounding wire is used, it is recommended that a qualified electrician determine that the grounding path is adequate.

A 120-volt, 60-Hz, AC-only, 15-ampere, fused electrical supply is required. A time-delay fuse or circuit breaker is recommended. It is recommended that a separate circuit serving only this appliance be provided.

Electronic ignition systems operate within wide voltage limits, but proper grounding and polarity are necessary. In addition to checking that the outlet provides 120-volt power and is correctly grounded, the outlet must be checked by a qualified electrician to see if it is wired with correct polarity.

A wiring diagram is included in the literature package. The wiring diagram is also located on the back of the range.

Recommended grounding method

For your personal safety, this appliance must be grounded. This appliance is manufactured with a power supply cord having a 3-prong grounding plug. To minimize possible shock hazard, the cord must be plugged into a mating, 3-prong, grounding-type, wall receptacle, grounded in accordance with the National Electrical Code, ANSI/NFPA 70 — latest edition*, and all local codes and ordinances. (See Figure 1.) If a mating wall receptacle is not available, it is the personal responsibility and obligation of the customer to have a properly grounded, 3-prong, wall receptacle installed by a qualified electrician.

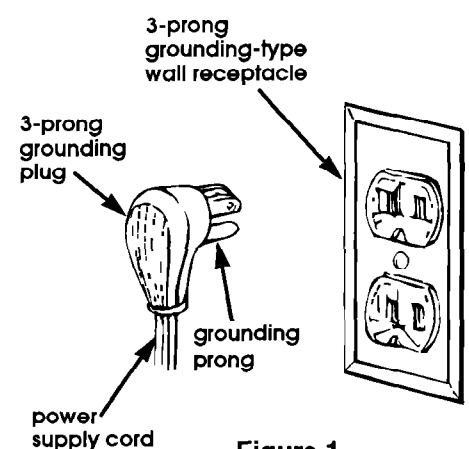
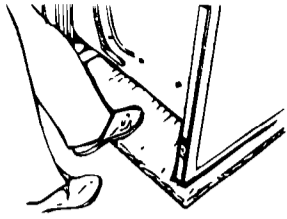

Figure 1

Now start... With range in kitchen.

1. Remove racks and other parts from inside oven.



2. Place one foot on the shipping base. Tilt range forward slightly to free rear legs. Gently lower range to floor. Tilt range backwards until front legs are free.

3. Remove shipping materials, tape and protective film from range. Do Not remove cardboard shipping base at this time.

4. Lower leveling legs approximately 1/4 inch or to a point where the range base does not touch the floor.

WARNING

Personal Injury Hazard

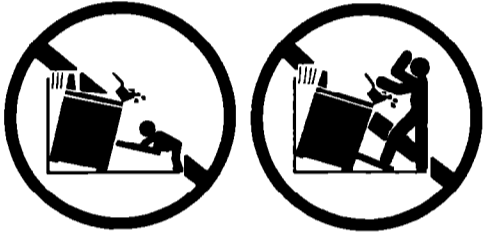

- To reduce the risk of tipping of the appliance, the appliance must be secured by properly installed floor- or wall-mounted anti-tip bracket supplied with the range.
- Save these installation instructions. If range is moved to a new location, the anti-tip bracket must be removed and reinstalled in the new location.

Electrical Shock Hazard

- Take special care when drilling holes into the floor. Electrical wires or plumbing may be located beneath floor.
- Locate the electrical circuits that could be affected by the installation of these brackets and turn off power to these circuits.

Failure to follow these instructions may result in electrical shock or other personal injury.

5. The anti-tip bracket must be installed. Anti-tip bracket may be fastened to the floor under the range or to the wall behind range.

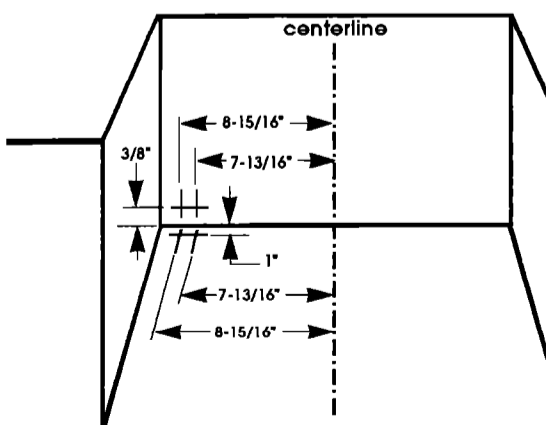

To install anti-tip bracket on wall:

- Measure and mark a line at the center of the cabinet opening on the rear wall. Measure and mark lines 7-13/16" and 8-15/16" from either the left or right side of the centerline on the rear wall. Measure and mark on the rear wall a line 3/8" from the floor.

To install anti-tip bracket on floor:

- Measure and mark a line in the center of the cabinet opening on the floor. Measure and mark lines 7-13/16" and 8-15/16" from either the left or right side of the centerline on the floor. Measure and mark on the floor 1" from the rear wall.

Note: If there is a cabinet on only one side, the anti-tip bracket must be installed against the cabinet, using the measurements given.

CAUTION

Floor Damage

- Contact a qualified floor covering installer for the best procedure to drill mounting holes through your type of floor covering.
- Before moving range across floor, check that range is on shipping base or slide range onto cardboard or hardboard.

Failure to follow these instructions may result in damage to floor covering.

6. To mount anti-tip bracket to wood floor or wall, drill 1/8" holes at two mounting screw locations where the two lines are crossed by the third line.



To mount anti-tip bracket to concrete or ceramic floor or wall, use a masonry drill bit to drill 1/4" holes at each mounting screw location. Tap plastic anchors into mounting holes in floor or wall with hammer.

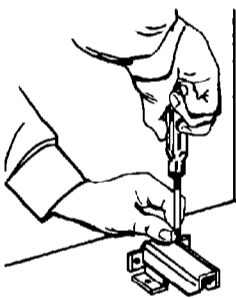
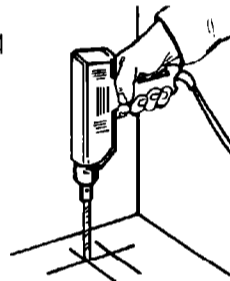

7. Line up holes in anti-tip bracket with holes in floor or wall. Use the screws provided to fasten the anti-tip bracket to floor or wall.

8. Move range close to final position. Remove shipping base, cardboard or hardboard from under the range. Plug power supply cord into grounded outlet.

9. Carefully move range into final position. Look under range. (A flashlight may be needed.) Check that the anti-tip bracket overlaps range base. If anti-tip bracket does not overlap base, remove range and reposition bracket to insure that range base will fit properly under bracket.

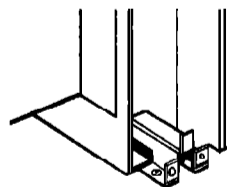

10. If installing the range in a mobile home, you MUST secure the range to the floor. Any method of securing the range is adequate as long as it conforms to the standards listed in the Mobile home installation instructions, Panel A.

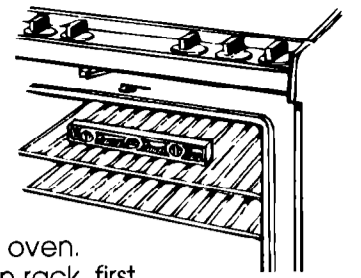

11.

Place rack in oven. Place level on rack, first side to side; then front to back. If the range is not level at the front, adjust the legs. If rear of range needs more than 1/8" adjustment, add shims under anti-tip bracket.

Note: Oven must be level for satisfactory baking conditions.

WARNING

Fire Hazard

Do Not make connection too tight. The regulator is die cast. Overtightening may crack the regulator, resulting in a gas leak and possible fire or explosion.

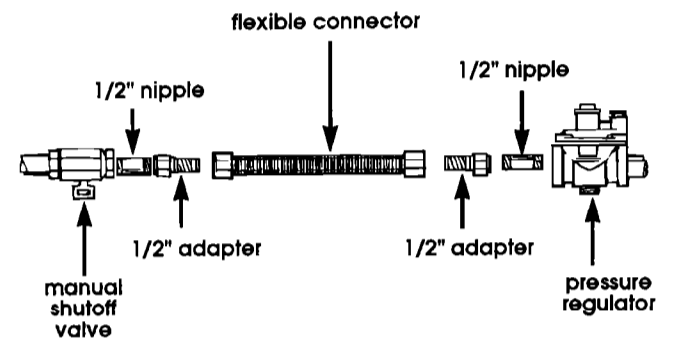

All connections must be wrench-tightened.

12. Remove burner grates. Lift up or remove maintop. Assemble the flexible connector from the gas supply pipe to the pressure regulator supply pipe in this order: manual shutoff valve, 1/2" nipple, 1/2" adapter, flexible connector, 1/2" adapter, and 1/2" nipple.

13. Use pipe-joint compound made for use with L.P. gas to seal all gas connections. If flexible connectors are used, be certain connectors are not kinked.

14. Open the shutoff valve in the gas supply line. Wait a few minutes for gas to move through the gas line.

WARNING

Fire Hazard

Do Not use an open flame to test for leaks from gas connections. Checking for leaks with a flame may result in a fire or explosion.

15.

Use a brush and liquid detergent to test all gas connections for leaks. Bubbles around connections will indicate a leak. If a leak appears, shut off gas valve controls and adjust connections. Then check connections again. **NEVER TEST FOR GAS LEAKS WITH A MATCH OR OTHER FLAME.** Clean all detergent solution from range.

Initial lighting and gas flame adjustments depend on type of system —

electronic ignition or standing pilot. Raise maintop and check which system is available. Continue installation, following steps under the heading for this range's system.

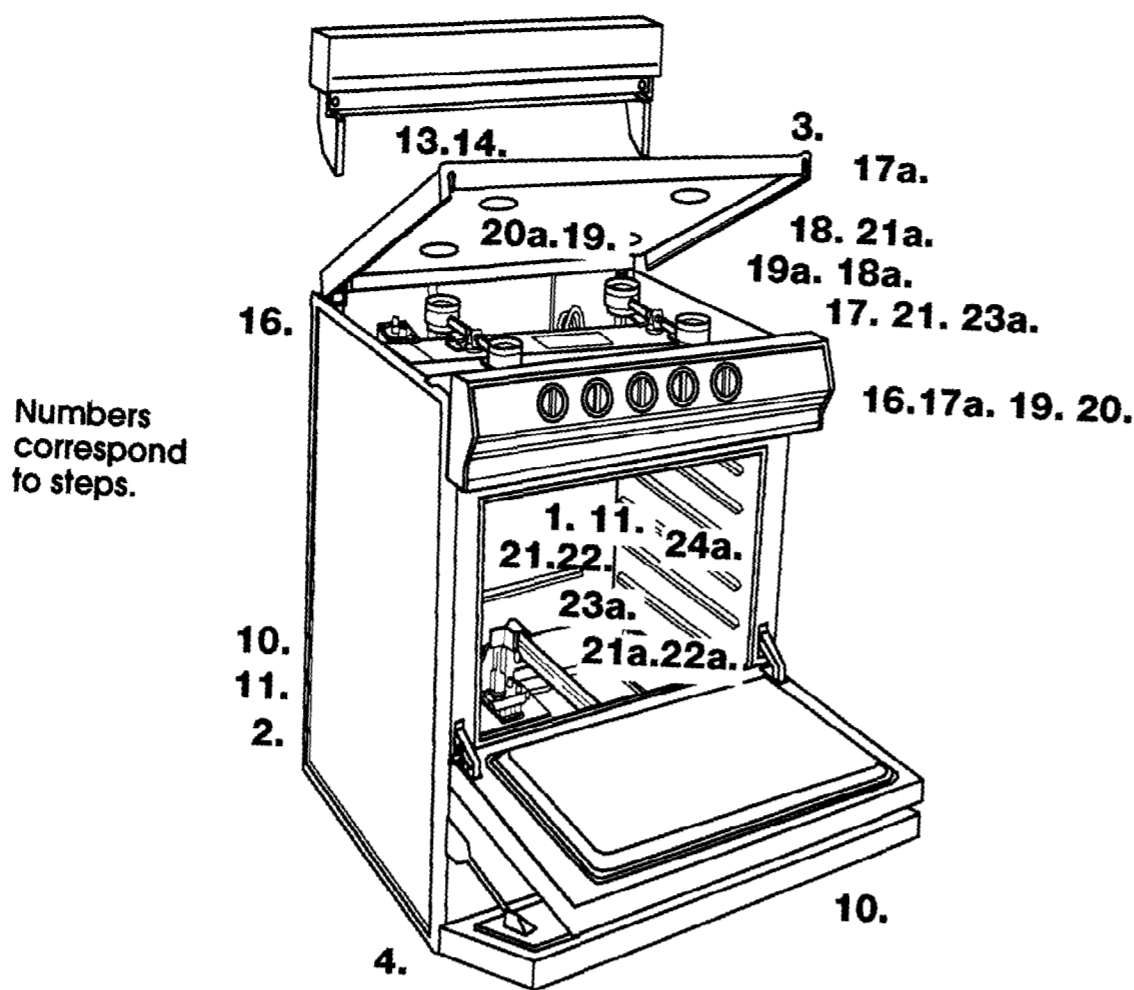

Numbers correspond to steps.

Electronic Ignition System

Cooktop and oven burners use electronic ignitors in place of standing pilots. When the cooktop control knob is turned to the "LITE" position, the system creates a spark to light the burner. This sparking continues until the control knob is turned to the desired setting. When the oven control is turned on, the ignitor will spark until oven burner pilot is lit.

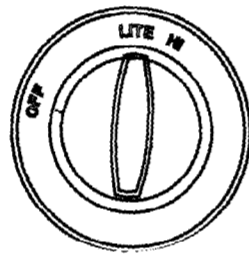

16.

Check the operation of the cooktop burners. Push in and turn each control knob to "LITE" position. The flame should light within 4 seconds. **Do Not leave the knob in the "LITE" position after burner lights.**

17.

After burner lights, turn control knob to "HI" position. Check each cooktop burner for proper flame. The small inner cone should have a very distinct blue flame 1/4" to 1/2" long. The outer cone is not as distinct as the inner cone.

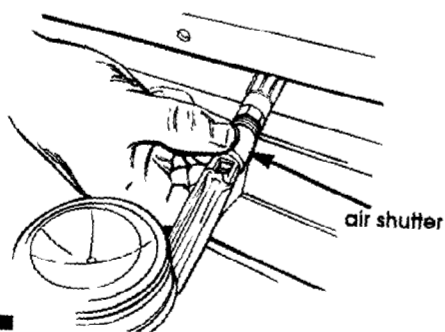

18.

If burners need adjusting for proper flame, adjust the air shutter to the widest opening that will not cause the flame to lift or blow off the burner. Repeat as necessary with each burner.

19.

Push in and turn each control knob to the "LITE" position and then to a low position. The low flame should be a minimum, steady, blue flame. Replace maintop and burner grates.

20.

Check the oven burner for proper flame. Open the oven door and broiler drawer. Remove the lower oven rack and oven bottom. Push in and turn oven control knob to 300°F. **The oven burner should light in 50-60 seconds. This delay is normal.** The oven safety valve requires a certain time before it will open and allow gas to flow.



21.

Check the oven burner for proper flame. This flame should be 1/2" long, with inner cone of bluish-green, an outer mantle of dark blue and should be clean and soft in character. No yellow tips, blowing or lifting of flame should occur.

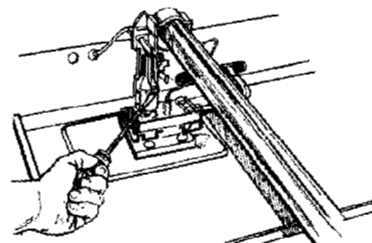

22.

If oven flame needs to be adjusted, turn oven off. Loosen screw and adjust air shutter. Turn oven back on and check flame. Repeat as needed until proper flame appears. Tighten screw. Replace oven bottom and oven racks. Close broiler drawer.

Standing Pilot System

16a.

Be sure all control knobs are in the "OFF" position. Raise, or lift off the maintop.

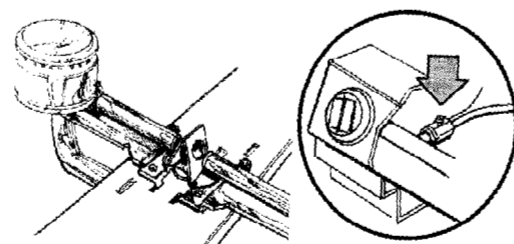

Use a match to light both pilots. Adjust pilot adjustment screw so pilot flame tip is 1/4" to 3/8" high and centered in the hole in the pilot housing. The adjustment control is located on the manifold pipe or pilot flame base, depending on the model. If the flame is too high, carbon (soot) will accumulate under the maintop.

17a.

Check the operation of the cooktop burners. Push in and turn each control knob to "LITE" position. The flame should light within 4 seconds. **Do Not leave the knob in the "LITE" position after burner lights.**

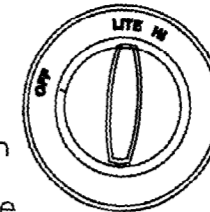

18a.

After burner lights, turn control knob to "HI" position. Check each cooktop burner for proper flame. The small inner cone should have a very distinct blue flame 1/4" to 1/2" long. The outer cone is not as distinct as the inner cone.

19a.

If burners need adjusting for proper flame, adjust the air shutter to the widest opening that will not cause the flame to lift or blow off the burner. Repeat as necessary with each burner.

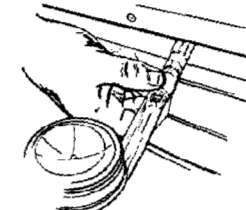

20a.

Push in and turn each control knob to the "LITE" position and then to a low position. The low flame should be a minimum, steady, blue flame. Replace maintop and burner grates.



21a.

Make sure the oven control knob is in the "OFF" position. Open the oven door and broiler drawer. Remove the lower oven rack and oven bottom. Hold a lighted match to the opening in the top of the pilot at the rear of the oven burner. No pilot adjustments are required.

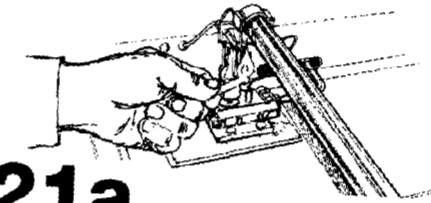

22a.

Check the operation of the oven burner. Push in and turn the oven control knob to 300°F. **The oven burner should light in 50 to 60 seconds. This delay is normal.** The oven safety valve requires a certain time before it will open and allow gas to flow.

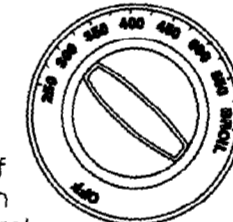

23a.

Check the oven burner for proper flame. This flame should be 1/2" long, with inner cone of bluish-green, and outer mantle of dark blue and should be clean and soft in character. No yellow tips, blowing or lifting of flame should occur.

24a.

If oven flame needs to be adjusted, loosen screw and adjust the air shutter until the proper flame appears. Tighten screw. Replace oven bottom and oven rack. Close broiler drawer.

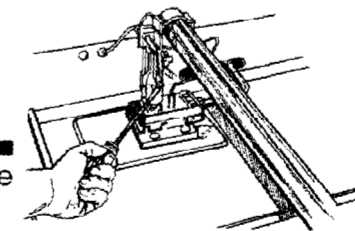

Congratulations!

You have just finished installing your new range. To get the most efficient use from your new range, read your Use & Care Guide. Keep Installation Instructions and guide close to range for easy reference. The instructions will make reinstalling your range in another home as easy as the first installation.

L.P. gas conversion

Converting from Natural gas to L.P. gas should be done by a qualified installer.

WARNING

Fire Hazard

- Locate gas supply valve between pressure regulator and gas valve. Shut off main gas supply line valve.
 - Make all cooktop and oven burner conversions before turning gas supply valve back on.
- Failure to follow these instructions could result in fire, explosion or other personal injury.

A.

Complete installation Steps 1-12 before converting your range to L.P. gas. Open oven drawer and broiler door. Remove oven racks and oven bottom. Remove burner grates and carefully lift up or remove maintop.

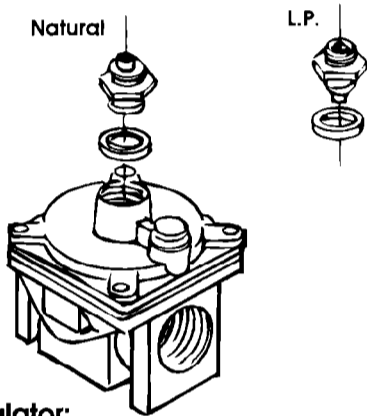

B.

Pressure regulator:

Use a wrench to unscrew the cap from the top by turning counterclockwise. Turn the cap over so the hole end is up. Replace the cap and gasket on the regulator. **DO NOT REMOVE THE PRESSURE REGULATOR.**

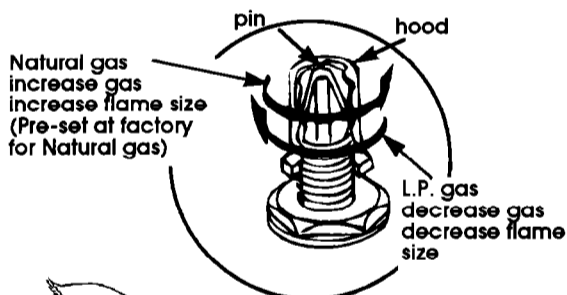

C.

Cooktop burners:

Turn the orifice hoods down snug onto pins (approximately 2 to 2-1/2 turns). **DO NOT OVERTIGHTEN.** The burner flames cannot be properly adjusted if this conversion is not made.

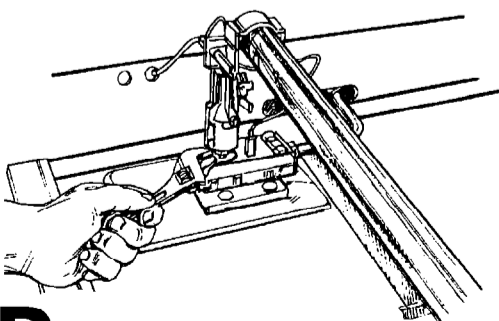

D.

Oven burner:

Turn the orifice hood down snug onto pin (approximately 2 to 2-1/2 turns). **DO NOT OVERTIGHTEN.** The burner flames cannot be properly adjusted if this conversion is not made.

Panel E

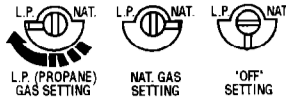
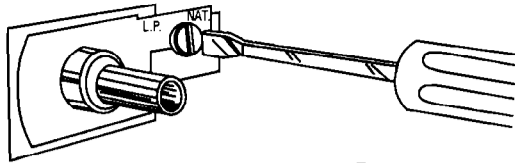

E.

Oven thermostat: Remove thermostat knob, pulling straight off. Use a small screwdriver to rotate the key to "L.P." Replace thermostat knob.

F.

After all the burners have been converted to L.P. gas usage, complete Steps 13-15, Panel C.

Adjusting for proper flame

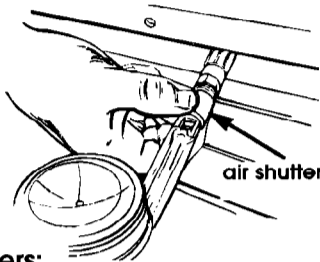

A.

Cooktop burners:

Adjust the air shutters for proper flame by sliding the air shutter to close or open the shutter as needed. See Panel D, Steps 16-19 for electronic ignition system, or 16a-20a for standing pilot system. L.P. gas has a slightly yellow tip on top of burner flames in addition to the other proper characteristics.

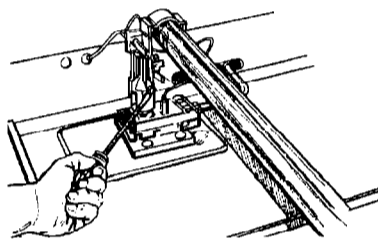

B.

Oven burner:

Loosen screw and adjust the air shutter as needed. See Panel D, Steps 20-22 for electronic ignition system, or 21a-24a for standing pilot system. The flame should be 1/2" long with an inner cone of bluish-green and outer mantle of dark blue. The flame should also be clear and soft in character with no blowing or lifting of flame. Tighten screw.

C.

Close broiler drawer. Replace oven bottom and oven rack. Close oven door. Reinstall maintop and burner grates.

Natural gas conversion

Converting from L.P. gas to Natural gas should be done by a qualified installer.

WARNING

Fire Hazard

- Locate gas supply valve between pressure regulator and gas valve. Shut off main gas supply line valve.
 - Make all cooktop and oven burner conversions before turning gas supply valve back on.
- Failure to follow these instructions could result in fire, explosion or other personal injury.

A.

Open oven door and broiler drawer. Remove oven racks and oven bottom. Remove burner grates and carefully lift up or remove maintop.

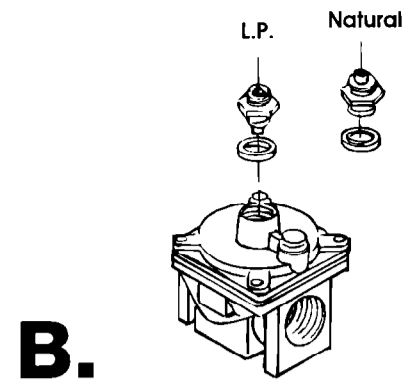

B.

Pressure regulator:

Use a wrench to unscrew the cap from the top by turning counterclockwise. Turn the cap over so the hole end is down. Replace the cap and gasket on the regulator. **DO NOT REMOVE THE PRESSURE REGULATOR.**

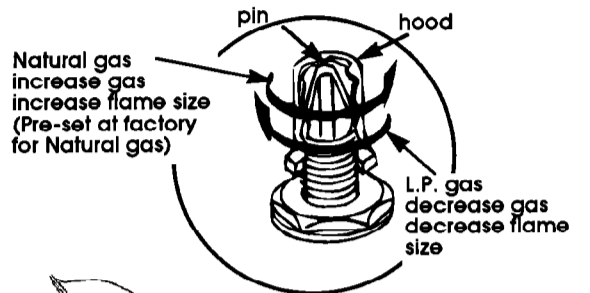

C.

Cooktop burners:

Loosen the orifice hoods away from pins 2 to 2-1/2 turns. The burner flames cannot be properly adjusted if this conversion is not made.

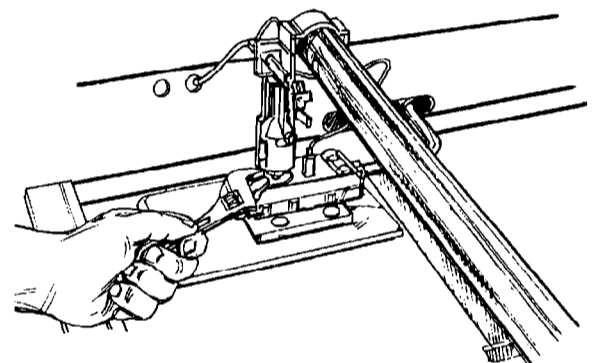

D.

Oven burner:

Loosen the orifice hood away from pin 2 to 2-1/2 turns. The burner flame cannot be properly adjusted if this conversion is not made.

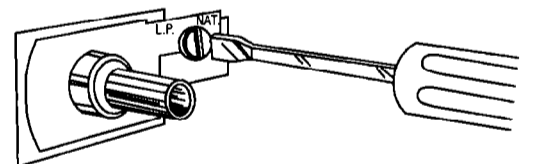

E.

Oven thermostat: Remove thermostat knob, pulling straight off. Use a small screwdriver to rotate the key to "NAT." Replace thermostat knob.

Adjusting for proper flame

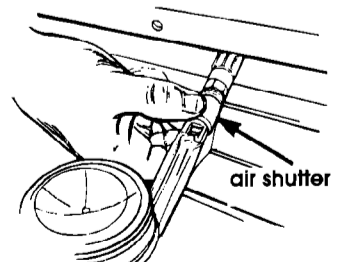

A.

Cooktop burners:

Adjust the air shutters for proper flame by sliding the air shutter to close or open the shutter as needed. See Panel D, Steps 16-19 for electronic ignition or Panel D, Steps 16a-20a for standing pilot system.

B.

Oven burner:

Adjust the air shutter as needed for proper flame. See Panel D, Steps 20-22 for electronic ignition or 21a-24a for standing pilot system.

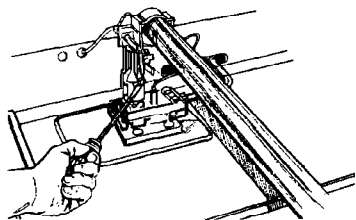

C.

Replace oven racks and oven bottom. Replace oven door and broiler drawer. Reinstall maintop and burner grates.

If range does not operate...

- Check that the circuit breaker is not tripped or the house fuse blown.
- Check that power supply cord is plugged into wall receptacle.
- Check that the gas supply is turned on.

NOTE:

Refer to Use and Care Guide for operating instructions and cleaning instructions.



WARNING

Personal Injury/Product Damage Hazard

Do Not step, lean or sit on the range drawer or door.

Failure to follow these instructions could result in personal injury and/or product damage.

For cleaning and maintenance...

If removing the range is necessary for cleaning and maintenance, shut off gas supply to the range. Disconnect the gas and electrical supply.

If the gas or electrical supply is inaccessible, lift the range slightly at the front and pull the range away from the wall. Pull the range out only as far as necessary to disconnect the gas and electrical supply lines.

Remove the range to complete cleaning or maintenance.

Move range back into operating position. Level the range. Connect the gas line to the range and check for leaks. Plug power supply cord into outlet.

Make sure the anti-tip bracket overlaps range base.

If you need assistance...

Check your Use and Care Guide for a toll-free number to call, or call the dealer from whom you purchased this appliance. The dealer is listed in the Yellow Pages of your phone directory under "Appliances — Household — Major — Service and Repair."

When you call, you will need the range model number and serial number. Both numbers can be found on the serial/rating plate located under the maintop.



Printed on recycled paper,
10% post consumer waste/
50% recovered materials.