



Fresh Clean Water



**Use & Care
Guide and
Installation
Instructions**

**WHIRLPOOL
UNDERCOUNTER
REVERSE OSMOSIS
WATER FILTRATION
SYSTEM IV**

9193

Water Filtration System Parts

Remove parts from packages.
Check that you have all the parts.

- storage tank with base (A)
- filtration assembly cover (B)
- two mounting screws (C)
- 9-volt battery (D)
- filtration assembly (E)
- 3/8" blue tubing (F)
- 1/4" yellow tubing (G)
- 1/4" orange tubing (H)
- RO membrane cartridge (I)
- 3/8" black tubing (J)
- 1/4" red tubing with push-in connector attached (K)
- 1/4" green tubing (L)
- drain saddle elbow (M)
- drain saddle valve assembly (N)
- air-gap faucet assembly:
 - faucet spout (O)
 - faucet base (P)
 - chrome base plate (Q)
 - LED indicator disk (R)
 - rubber washer (S)
 - slotted washer (T)
 - spacer (U)
 - flat washer (V)
 - 1/4" hex nut (W)
 - 3/8" grey connector with push-in end (X)
- packet of extra o-rings (Y)
- saddle valve assembly (Z)
- insert (AA)
- plastic sleeve (BB)
- brass compression nut (CC)
- nitrate test kit (DD)
- literature package

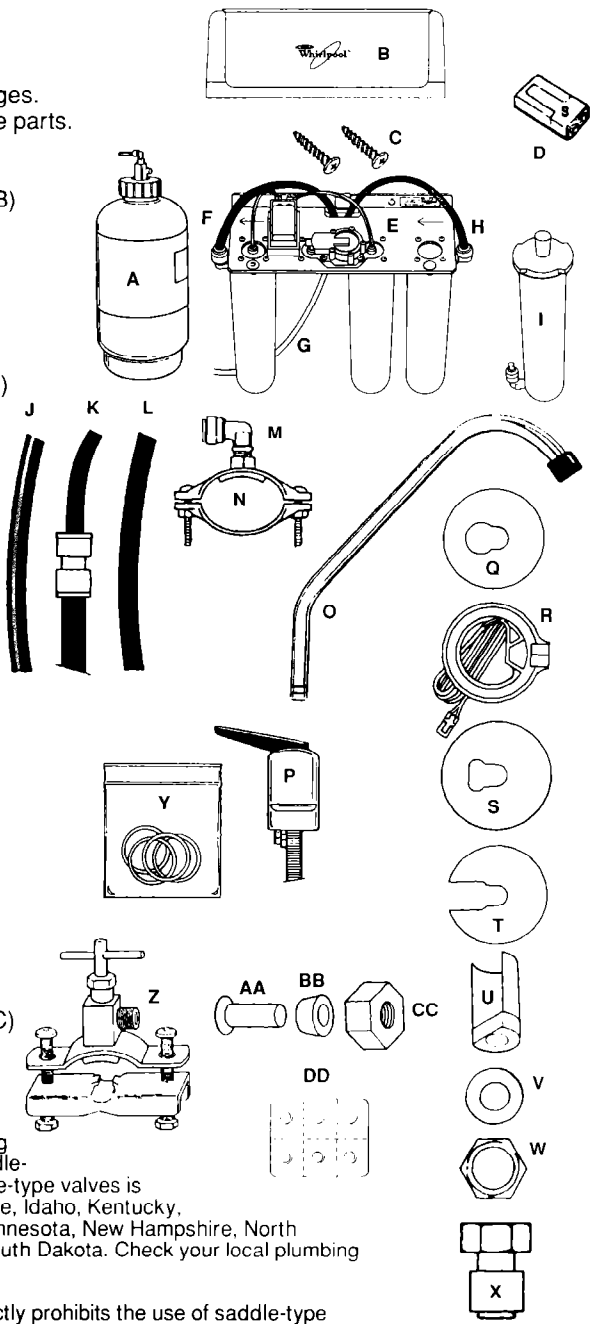

NOTE:
Some state and local plumbing codes prohibit the use of saddle-type valves. The use of saddle-type valves is prohibited in: Alaska, Delaware, Idaho, Kentucky, Massachusetts, Michigan, Minnesota, New Hampshire, North Dakota, Ohio, Oregon and South Dakota. Check your local plumbing codes for details.

Massachusetts CMR 248 strictly prohibits the use of saddle-type valves. The feed-water connection must conform to applicable plumbing codes.

Tools Needed for Installation

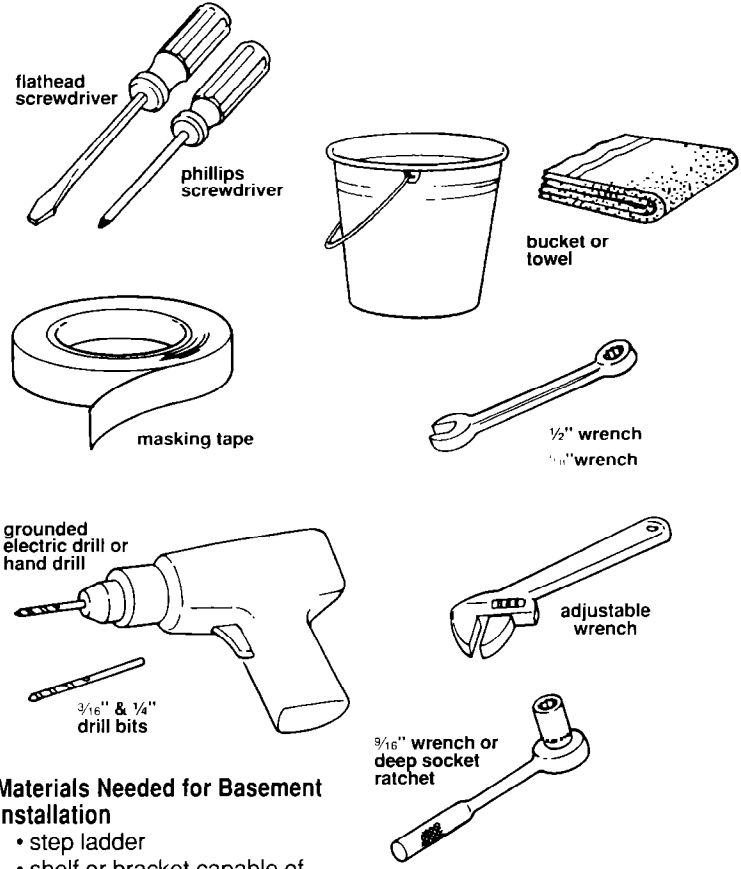

- Materials Needed for Basement Installation**
- step ladder
 - shelf or bracket capable of supporting 16 pounds
 - 1/4" drill bit
 - safety glasses
 - Basement Installation Kit, Part No. 4373517 available from your Whirlpool dealer.

Open This Flap For Installation Overview

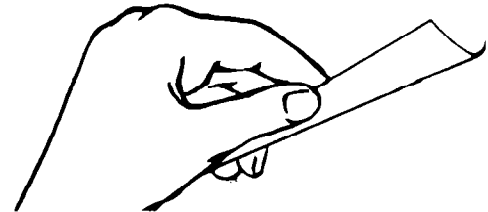

Installation Overview

Before You Start ...

IMPORTANT: Read and save these instructions.

It is recommended that this system be installed by a licensed plumber. It is the responsibility of the installer to comply with the installation specifications provided and with state and local plumbing codes.

If you decided to install the system yourself, see "General Information" on page 13 before continuing.

Water Filtration System IV can be installed in the basement if there is not adequate room for under-sink installation, however, no more than 14 additional feet of tubing should be used. Order Basement Installation Kit, Part No. 4373517 from your Whirlpool dealer and follow the kit instructions. DO NOT use filtration system if water is microbiologically unsafe or water quality is unknown. Pretreat water that exceeds limits for hardness, iron, manganese, and hydrogen sulfide.

If you need assistance ...

Refer to the Use & Care information at the end of this booklet. If you need more help, the Whirlpool Consumer Assistance Center will answer any questions you may have about operating or maintaining your RO water filtration system. The Whirlpool Consumer Assistance Center is open 24 hours a day, 7 days a week. Just dial 1-800-253-1301—the call is free. When you call, you will need the RO water filtration system model number and serial number. Both numbers can be found labeled on the top right side of filtration assembly.

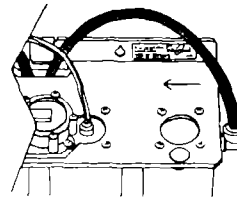

Reverse Osmosis Water Filtration System

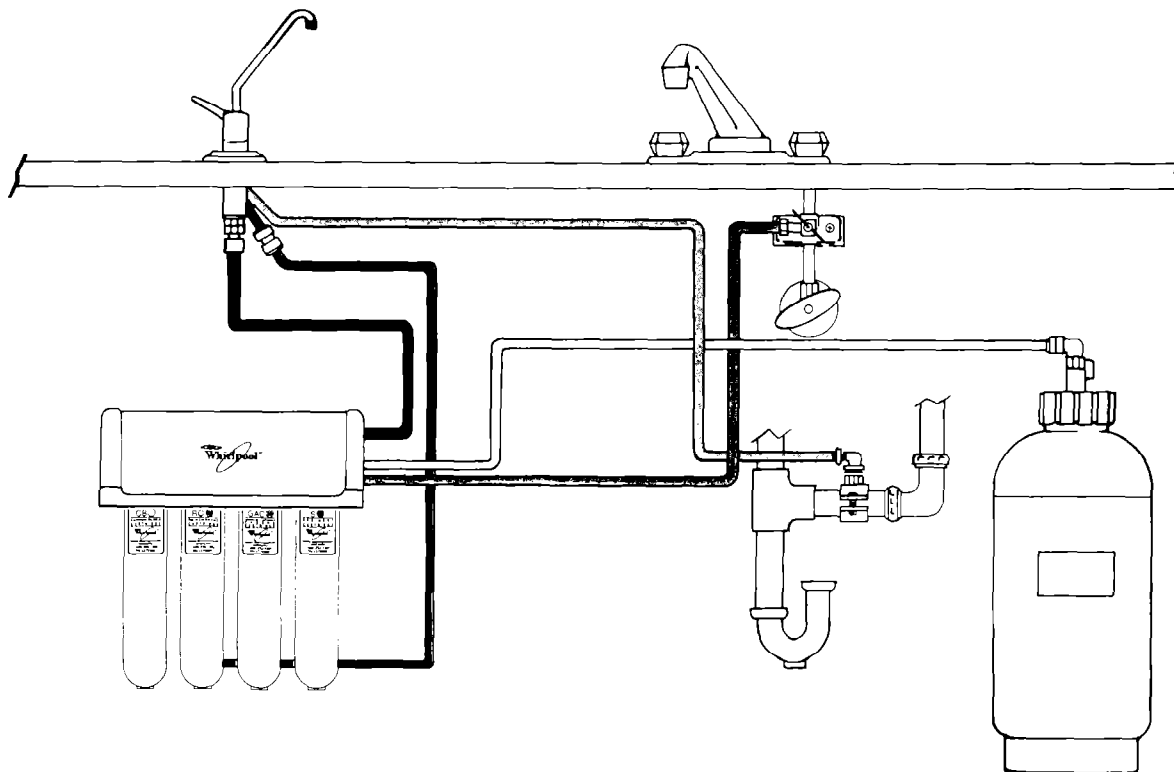

HOOK UP WATER

- Turn off cold water supply.
- Turn on faucet to drain water from line.
- Connect saddle valve to cold water supply.
- Turn saddle valve handle clockwise until piercing lance enters pipe and stops.

CONNECT FAUCET

- Connect faucet spout, chrome base plate, indicator light disk and rubber washer to faucet base.
- Connect green tubing and black tubing to faucet.
- Place faucet in sink opening. Secure faucet to sink with slotted washer, spacer, flat washer, hex nut and grey connector. Connect blue tubing to bottom of faucet assembly.
- Connect faucet indicator wire to wire harness on filtration assembly. Insert battery.

CONNECT TUBING

- Install RO cartridge into filtration assembly. Connect one end of red tubing to bottom of RO cartridge. Connect other end to green tubing from faucet.
- Connect orange tubing to saddle valve.
- Use orange tubing from filtration assembly to fill storage tank with water.
- Connect yellow tubing to storage tank.

CONNECT DRAIN

- Decide where drain saddle will be mounted. The best place is on a horizontal drain tailpiece above (before) the trap.
- Connect drain saddle to drain pipe.
- Drill hole in drain using opening in drain saddle as a guide.
- Thread elbow into drain saddle. Connect black tubing to elbow.

FLUSH SYSTEM

- Slide filtration assembly onto mounting screws.
- Turn on faucet and drain tank to flush disinfectant from tank.
- Turn on cold water supply and saddle valve.
- Allow tank to fill - approximately 4 hours. Lift faucet handle to drain tank. Fill and drain tank again - another 4 hours. Wait for tank to fill again. When faucet is turned on, green indicator light will indicate water is ready for use.

Hook Up Water

Instructions At A Glance • For detailed instructions see following page.

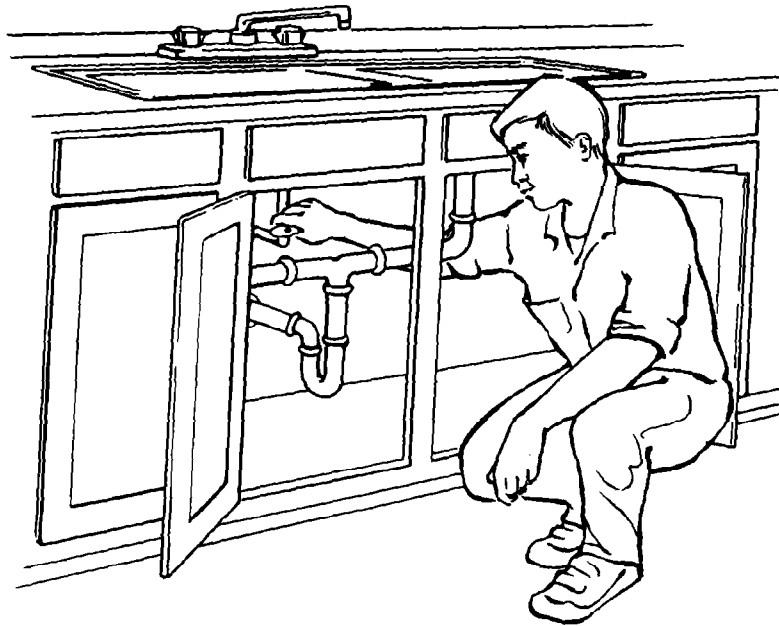

1. Turn off cold water supply. (Steps 1a-1b)

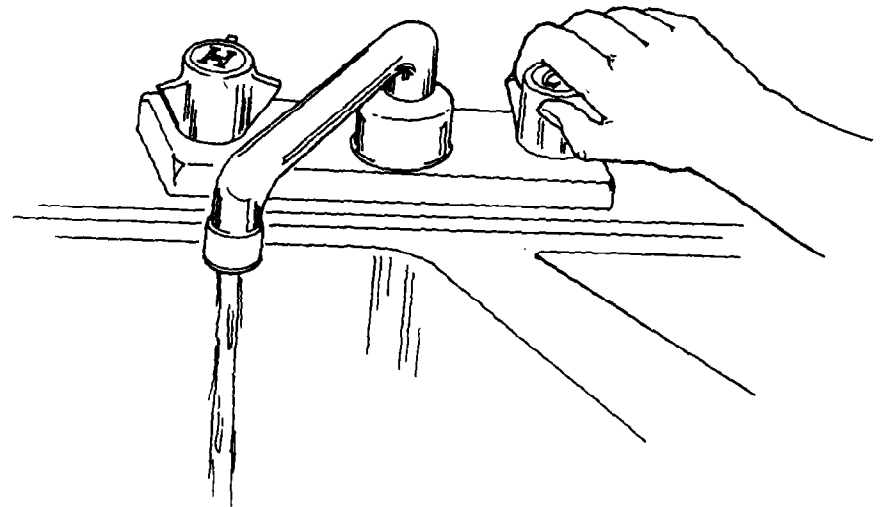

2. Turn on faucet to drain water from line. (Step 1b)

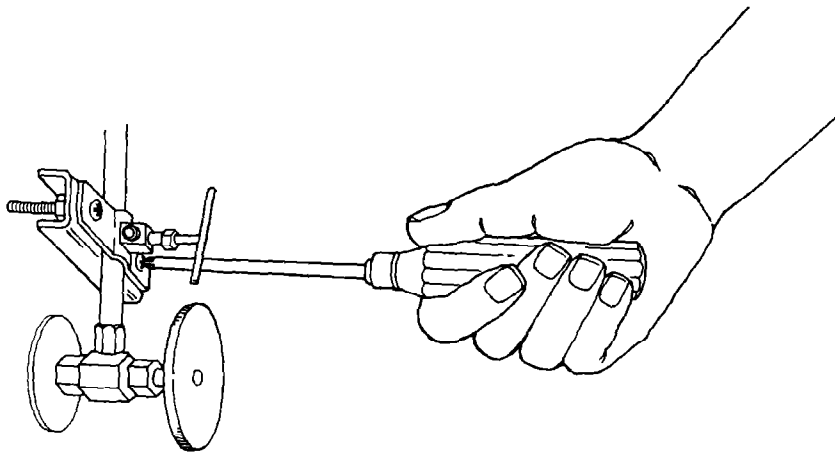

3. Connect saddle valve to cold water supply.
(Steps 1c-1e or 1h-1j)

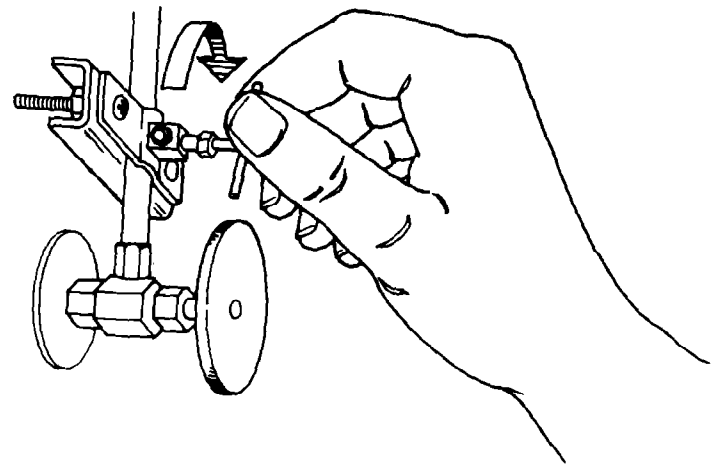

4. Turn saddle valve handle clockwise until piercing lance enters pipe and stops. (Steps 1f-1g or 1k-1l)

Hook Up Water

! CAUTION

Product Damage

DO NOT connect to a hot water supply line. Failure to follow this instruction could result in product damage.

1a. Take note of water requirements listed under the Use & Care section of this booklet. The filtration system's feed line (orange tubing) connects to your cold water supply line using the saddle valve.

Do not use saddle valve if it is prohibited by your state or local plumbing codes.

The saddle valve is for use with $\frac{3}{8}$ " to $\frac{1}{2}$ " outer diameter (O.D.), soft copper pipe (plain or chrome plated) or rigid metal or plastic pipe. **Important: DO NOT use the saddle valve on flexible ribbed tubing.** The wall thickness of flexible ribbed tubing is thin and will not support the saddle valve supplied.

If your cold water supply is connected to the cold water faucet with flexible ribbed tubing, contact your local plumbing supply distributor to obtain special connecting hardware.

Important: If local codes do not permit the use of saddle valves, special feed valves can be obtained from your local plumbing supply distributor. Use only $\frac{1}{4}$ " polyethylene tubing for water line connection. DO NOT USE COPPER TUBING.

! CAUTION

Property/Product Damage

- **DO NOT** install tubing in an area where temperatures drop below 32°F.
- **DO NOT** overtighten saddle valve to copper pipe. This will crush pipe.
- **Keep a bucket or towel** under area where saddle valve connection is made.

Failure to follow these instructions may result in water damage to property or product damage.

1b. **Turn off cold water supply.** Turn on cold water faucet and allow all water to drain from line. Turn off faucet. Determine if your cold water supply line is soft copper pipe or rigid metal or plastic pipe. If your cold water supply line is soft copper pipe proceed to step 1c. If your cold water supply line is rigid metal or plastic pipe, skip ahead to step 1h.

1c. **Connect saddle valve to cold water supply soft copper pipe.** Check that saddle valve piercing lance does not protrude beyond rubber gasket. If it is protruding, carefully push it in flush with the rubber gasket, using a hard object like the end of a screwdriver handle.

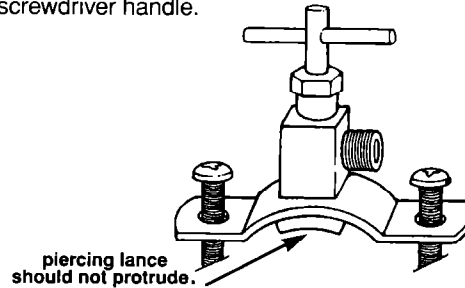

1d. Assemble both halves of saddle valve to cold water pipe. Saddle valve must be on top side of horizontal pipe or side of vertical pipe to keep sediment from collecting in its valve.

If you are connecting the saddle valve to $\frac{3}{8}$ " O.D. copper pipe, assemble bracket with projections against tubing to prevent distortion of tubing. If you are connecting the saddle valve to $\frac{7}{16}$ " or $\frac{1}{2}$ " O.D. pipe, assemble bracket with "v" side against pipe.

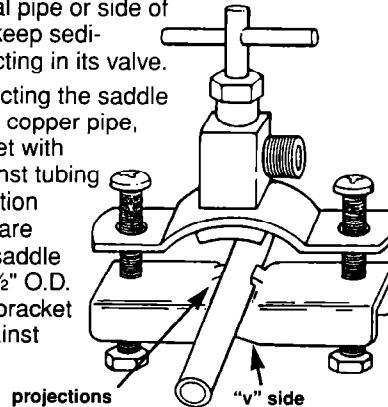

1e. Tighten screws evenly and firmly, keeping both halves parallel. **DO NOT** overtighten; copper pipe could be crushed.

1f. Have a towel ready in case of leakage. Turn saddle valve handle clockwise until the lance pierces soft copper pipe and then stops. Do not continue to turn the saddle valve handle after it has stopped because you may pierce through the opposite side of pipe. The saddle valve is now in the closed position.

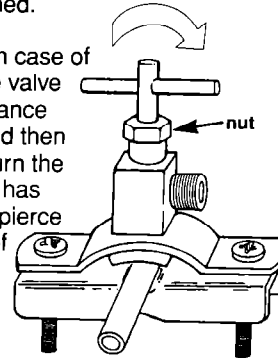

1g. Turn on cold water supply to check for leaks. In case of leaks, use an adjustable wrench to tighten nut below valve's handle. Turn cold water back off and proceed to step 2.

! WARNING

Electrical Shock Hazard

Special care must be taken when drilling into water pipes. Some water may remain in water supply pipe.

- If an electric drill is used, it must be properly grounded to prevent severe or lethal shock if water should enter drill.
- Use only an electric drill that is double insulated or properly grounded.
- Check with qualified electrician if you are in doubt as to whether your electric drill is properly grounded.
- Only drill at top or side of horizontal water supply pipe. **DO NOT** drill at bottom of horizontal pipe where water may remain.

Failure to follow these instructions could result in personal injury or death.

1h. **Connect saddle valve to cold water supply rigid metal or plastic pipe.** Use a grounded electric drill or hand drill to drill $\frac{3}{16}$ " hole in top side of horizontal pipe or side of vertical pipe. This will keep sediment from collecting in valve.

1i. Turn saddle valve handle clockwise to expose piercing lance a maximum of $\frac{3}{16}$ " beyond the rubber gasket.

1j. Align piercing lance over hole you drilled in pipe. Then assemble both halves of saddle valve on pipe with "v" side of bracket against pipe. Tighten screws evenly and firmly, keeping both halves parallel.

1k. Turn saddle valve handle clockwise until piercing lance enters hole in pipe and then stops. The saddle valve is now in the closed position.

1l. Have a towel ready in case of leaks. Turn on cold water supply to check for leaks. In case of leaks, use an adjustable wrench to tighten nut below valve. Turn cold water back off and proceed to step 2.

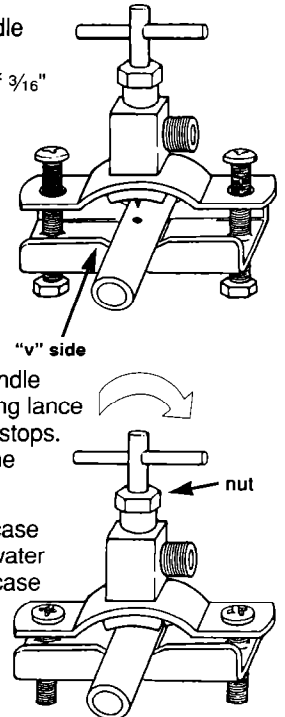

Connect Faucet

Instructions At A Glance • For detailed instructions see following page.

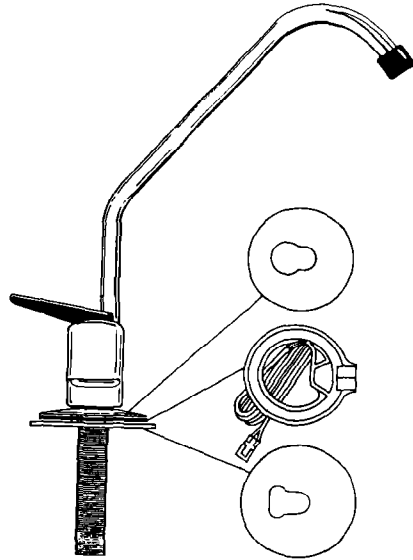

1. Connect faucet spout, chrome base plate, indicator light disk and rubber washer to faucet base. (Steps 2a-2b)

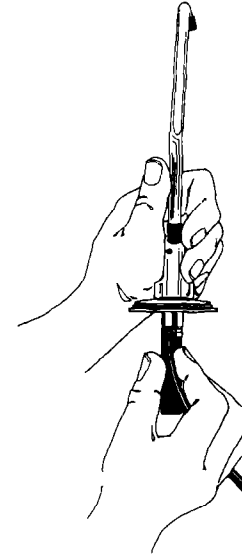

2. Connect green tubing and black tubing to faucet. (Steps 2c-2d)

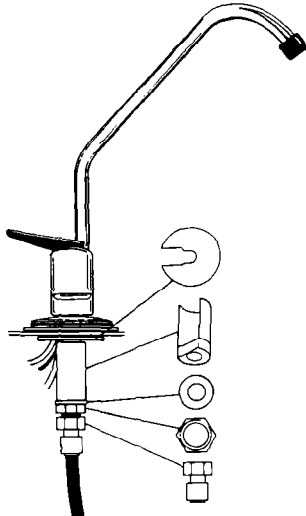

3. Place faucet in sink opening. Secure faucet to sink with slotted washer, spacer, flat washer, hex nut and grey connector. Connect blue tubing to bottom of faucet assembly. (Steps 2e-2j)

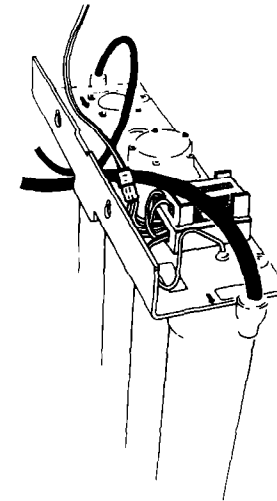

4. Connect faucet indicator wire to wire harness on filtration assembly. Insert battery. (Step 2k)

Connect Faucet

Front view of air gap faucet

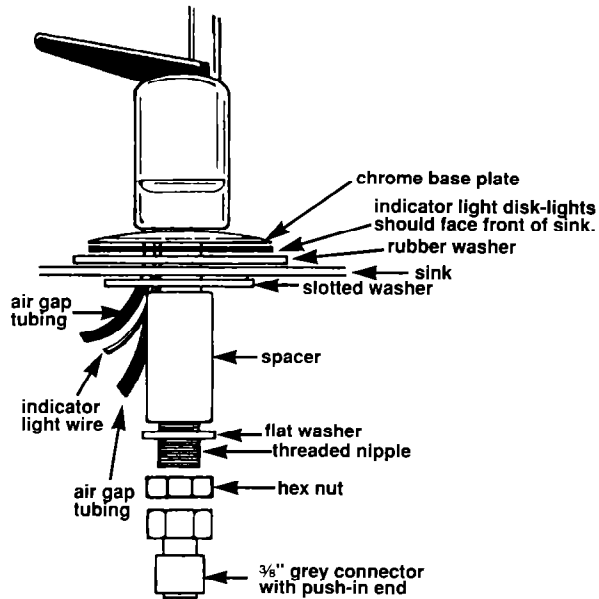

Side view of air gap faucet

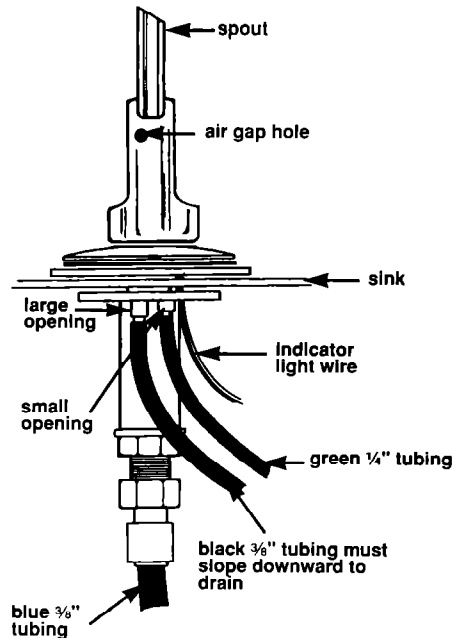

! CAUTION

Property Damage

- Contact a qualified installer or licensed plumber for cutting a faucet opening in your type of sink.
- Failure to do so may result in damage to the sink.

2a. A 7/8" to 1 1/8" diameter opening in the sink is required to install the faucet provided.

Important: If you do not have an existing sink opening, contact a qualified installer or licensed plumber to cut an opening in your sink.

2b. Air gap faucet installation - remove base of faucet from parts bag. Remove and discard small clear piece of tubing from opening on the top of the faucet's base. Push faucet spout into this opening on the top of the faucet's base. Assemble hardware onto faucet base in this order: chrome base plate, indicator light disk (lights should face front of sink), rubber washer (slip cord of indicator light disk through opening in rubber washer). Note: Rubber washer may be removed and replaced with a bead of plumber's putty for neater appearance. Determine which way handle should go.

! CAUTION

Property Damage

DO NOT cut or replace red tubing with white label. The full length is needed for proper operation of filtration system.

Failure to follow this instruction could result in product damage.

2c. Firmly push green tubing as far as it will go onto small opening of the air gap faucet.

2d. Firmly push black tubing as far as it will go onto large opening of the faucet.

2e. If your faucet hole is 1"-1 1/8", you can assemble spacer (open end up toward air gap tubing), flat washer, hex nut and 3/8" grey connector onto faucet's threaded nipple before inserting faucet in the faucet hole. Then secure faucet by inserting slotted washer between spacer and underside of faucet hole with open side of slotted washer toward air gap tubing. For smaller faucet hole openings follow steps 2f and 2g.



2f. Feed green and black tubing, indicator wire and threaded nipple through faucet hole in sink. Position faucet spout over sink and indicator light toward sink.

2g. Working below sink, assemble slotted washer, spacer (open end up toward air gap tubing), flat washer and hex nut onto faucet's threaded nipple. Make sure faucet is in proper position and tighten hex nut with a 9/16" wrench or deep socket ratchet until faucet is secure. Thread the 3/8" grey connector with push-in end onto faucet's threaded nipple. Tighten using 5/8" wrench.

2h. Recheck faucet position. Make sure indicator lights are facing the sink. If faucet position needs minor adjusting, wrap the flat chrome sides of faucet and the crescent portion of the crescent wrench with masking tape to protect the chrome from scratches. Use the wrench on flat sides of faucet to reposition faucet. Remove masking tape.

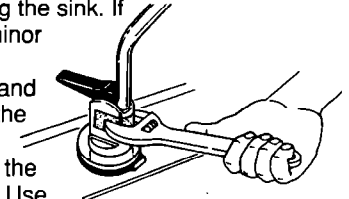

2i. Move filtration assembly near area where it will be mounted - either under sink or in the basement. For best results, locate filtration assembly so tubing can be cut to shortest length possible.

2j. Blue tubing from filtration assembly attaches to bottom of faucet's threaded nipple. The blue tubing should be cut to the shortest possible length. Use a plastic tubing cutter or sharp razor knife to cut blue tubing to shortest possible length. Make sure cut end is clean and blunt and tubing is round. Firmly push blue tubing from filtration assembly into push-in connector on the bottom of the faucet's threaded nipple.



2k. Remove filtration assembly cover by lifting it straight up. Connect the indicator disk's wire to the electronic harness on the top of the filtration assembly. Insert 9-volt battery in battery receptacle on top of the filtration assembly. Do not replace cover yet.



Connect Tubing

Instructions At A Glance • For detailed instructions see following page.

1. Install RO cartridge into filtration assembly. Connect one end of red tubing to bottom of RO cartridge. Connect other end to green tubing from faucet. (Steps 3a-3e)

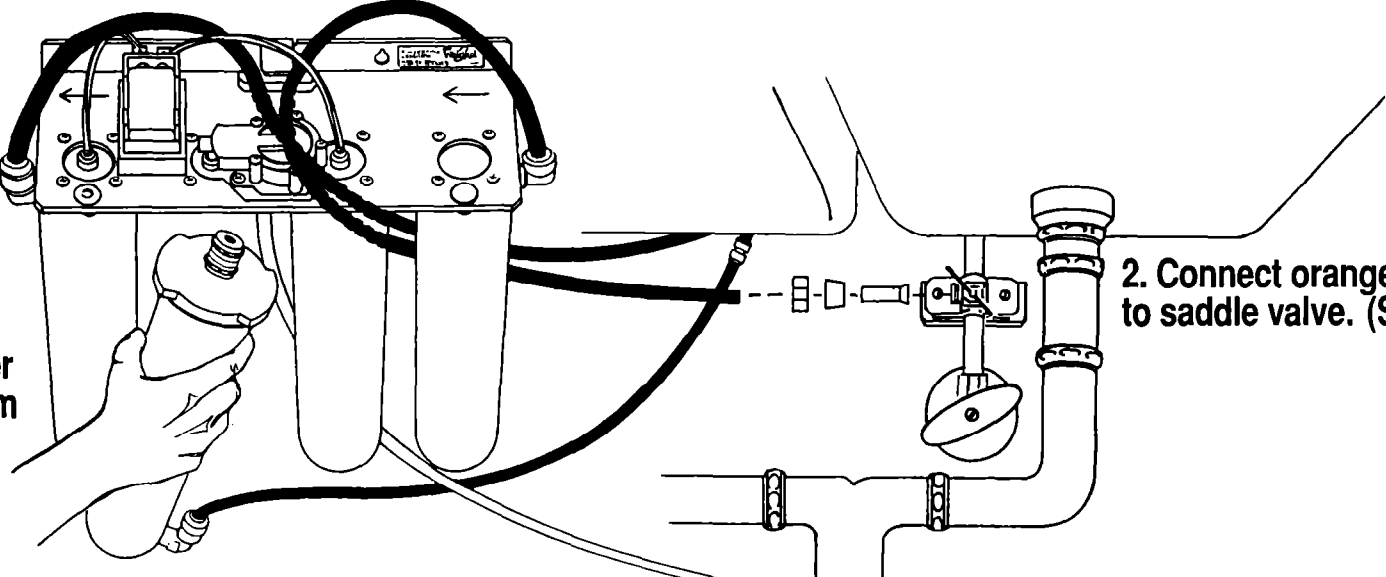

2. Connect orange tubing to saddle valve. (Step 3f)

4. Connect yellow tubing to storage tank. (Step 3i)

3. Use orange tubing from filtration assembly to fill storage tank with water. (Steps 3g-3h)

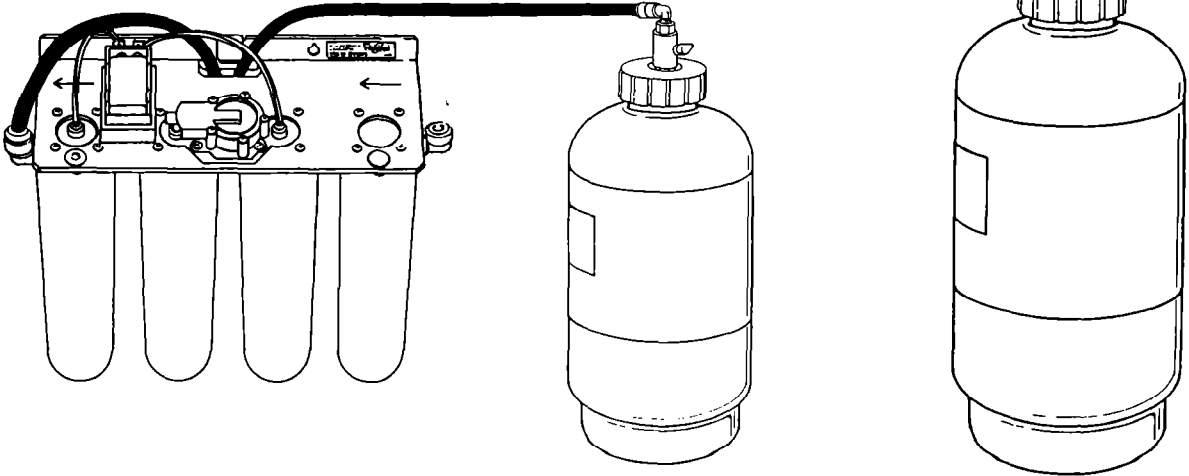

Connect Tubing

3a. The filtration assembly should already be placed close to its final location. Move storage tank near its final location, which should be within four feet of filtration assembly. The filtration assembly may be installed under a sink or in the basement (mounted to wood floor supports or to the basement wall). For basement installation order Basement Installation Kit, Part No. 4373517 available from your Whirlpool dealer.

! CAUTION

Property/Product Damage

DO NOT store or operate the RO water filtration system below 32°F.

Failure to follow above may result in water damage to property or product damage.

! WARNING

Electrical Shock Hazard

Special care must be taken when drilling into walls. Electrical wires may be concealed behind the wall covering.

- Use only an electric drill with a 3-wire power supply cord connected to a grounded receptacle.
- Check with qualified electrician if you are in doubt as to whether your electric drill is properly grounded.

Failure to follow these instructions could result in personal injury or death.

3b. If cabinet walls are not solid, place filtration assembly on cabinet floor against cabinet wall. If cabinet walls are solidly constructed, position filtration assembly on right or left cabinet wall 2 inches (minimum) above cabinet floor. Mark the location of mounting bracket holes. Then set water filtration assembly aside. Drill pilot holes for mounting bracket at locations marked on cabinet wall. Insert mounting screws in holes and tighten, leaving a slight gap between screw head and cabinet wall.

3c. Remove RO membrane cartridge from plastic bag. Hold the RO cartridge over the sink. Push in the grey push-in connector and hold; then pull short white plug out of connector and discard.

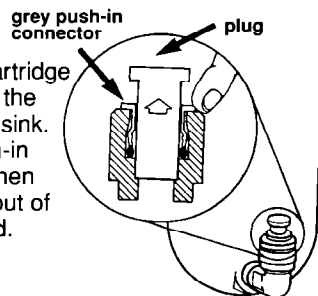

3d. Remove red cap from top of RO cartridge. Allow preservative from cartridge to drain into sink. Rinse off the cartridge with tap water and dry with a paper towel. Wet O-ring seals with a little water. Line up the tabs at the top of the RO cartridge with the slots in the filtration assembly's receptacle. Push cartridge up and turn it ¼ turn to the right to lock it in place. Cartridge label must face front. Pull down on RO cartridge to make sure it's firmly in place.

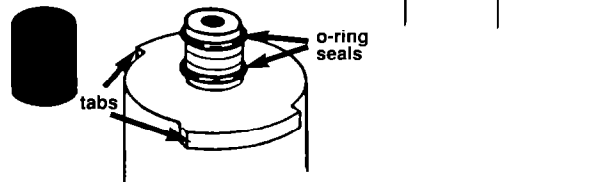

! CAUTION

Product Damage

DO NOT cut or replace red tubing with white label. The full length is needed for proper operation of the filtration system.

Failure to follow this instruction could result in product damage.

3e. Push the free end of red tubing into the grey push-in connector at the bottom of the RO cartridge as far as it will go. Red tubing from RO cartridge attaches to green tubing from faucet. Remove and discard short

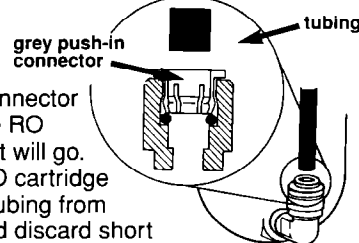

piece of blue tubing from push-in connector on other end of red tubing. The green tubing should be cut to the shortest length possible. Do not cut red tubing.

Push green tubing into grey push-in connector on the red tubing as far as it will go.



3f. To connect free end of orange tubing to saddle valve, place the brass compression nut on the orange tubing (threaded side out), place the plastic sleeve onto the tubing (discard brass sleeve), push the insert into the tubing and thread this assembly onto the opening of the saddle valve. Tighten brass compression nut with ½" wrench.

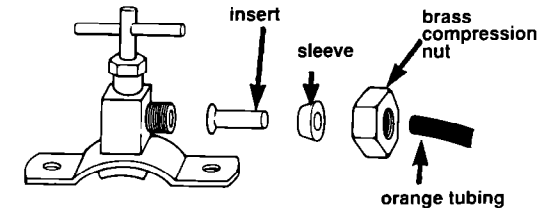

3g. The storage tank may sit vertically or horizontally within four feet of filtration assembly. If storage tank is to be mounted horizontally on the cabinet floor, use tank base as a cradle. To set tank vertically, attach base by inserting tabs on the tank bottom into notches on tank base and twist to the right as far as it will go.

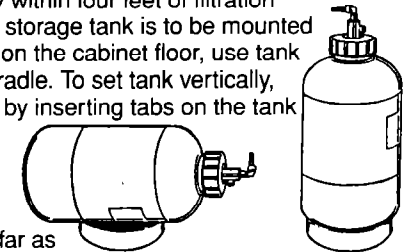

3h. Push in grey push-in connector on top of storage tank to remove small piece of tubing. Discard this tubing. The storage tank contains a special disinfectant and must be filled with water now. To do this, remove orange tubing from filtration assembly and push it into the storage tank's push-in connector as far as it will go. Turn storage tank's blue valve on (up). Turn on cold water supply. Turn saddle valve handle to the left to open. Allow tank to fill (approximately 3 minutes). Turn off cold water supply, saddle valve and tank's valve. Push in tank's push-in connector and remove orange tubing. Allow water from orange tubing to drain into a bucket. Reattach orange tubing to filtration assembly.

3i. To connect yellow tubing from filtration assembly to storage tank, cut yellow tubing to shortest length possible – no longer than 4 feet. Make sure end of tubing is clean and blunt and tubing is round. Push yellow tubing from the filtration assembly as far as it will go into storage tank's push-in connector.

Connect Drain

Instructions At A Glance • For detailed instructions see following page.

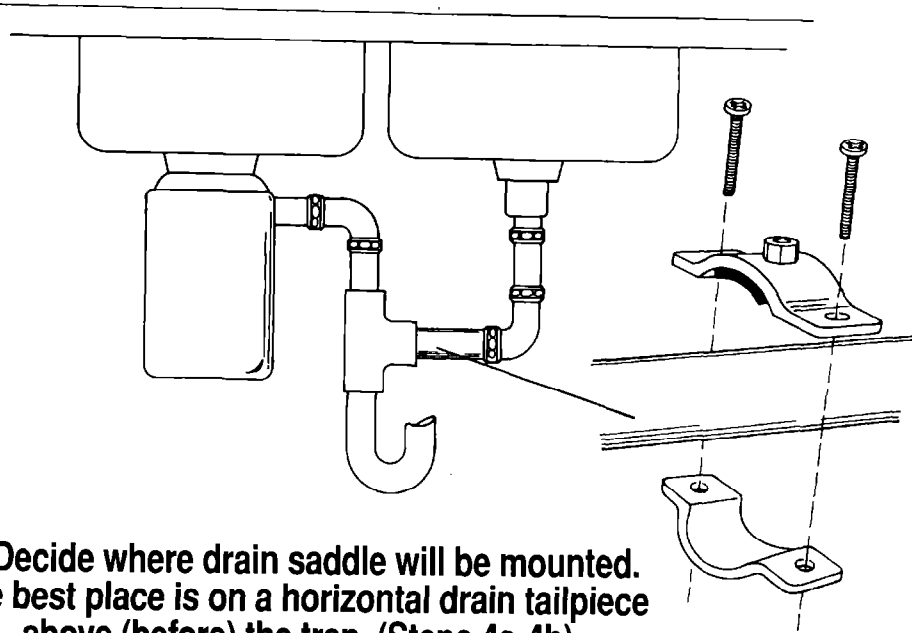

1. Decide where drain saddle will be mounted. The best place is on a horizontal drain tailpiece above (before) the trap. (Steps 4a-4b)

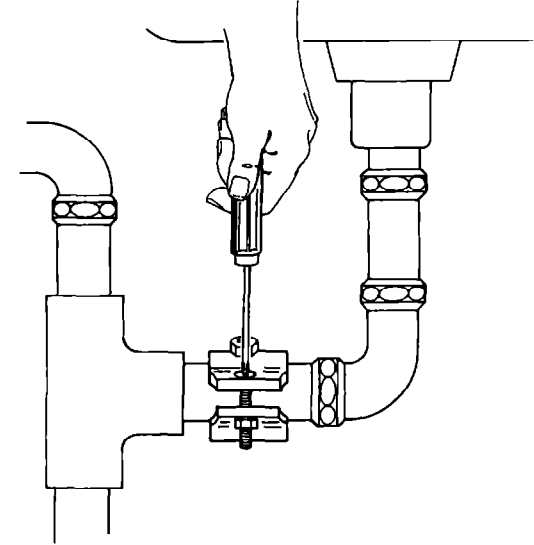

2. Connect drain saddle to drain pipe. (Step 4c)

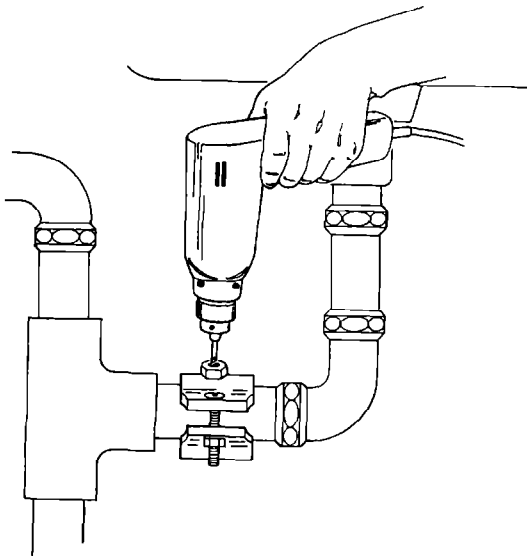

3. Drill hole in drain using opening in drain saddle as a guide. (Step 4d)

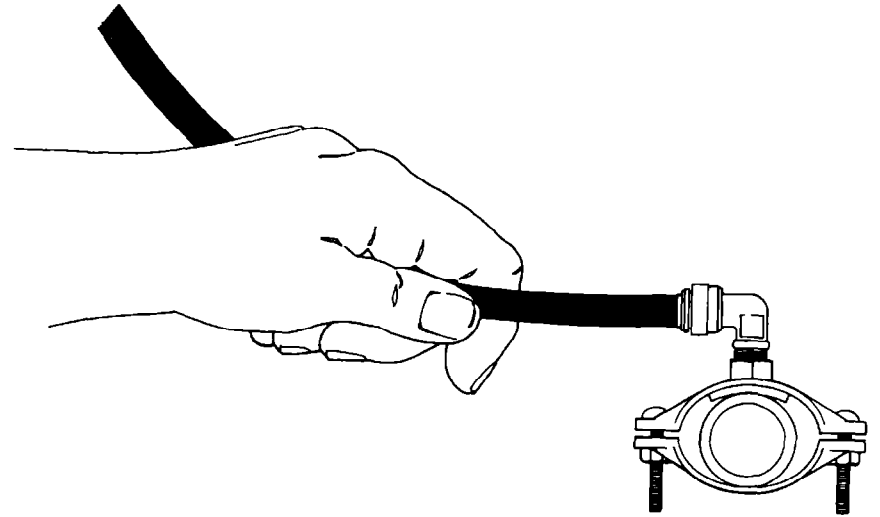

4. Thread elbow into drain saddle. Connect black tubing to elbow. (Steps 4e-4f)

Connect Drain

! WARNING

Electrical Shock Hazard

Special care must be taken when drilling into water pipes. Some water may remain in pipe.

- If an electric drill is used, it must be properly grounded to prevent severe or lethal shock if water should enter drill. Use only an electric drill with a 3-wire power supply cord connected to a grounded receptacle.
- Check with a qualified electrician if you are in doubt as to whether your electric drill is properly grounded.
- Only drill at top or side of horizontal drain pipe. DO NOT drill at bottom of horizontal pipe where water may remain.

Failure to follow these instructions could result in personal injury or death.

4a. Make sure sink faucet is turned off and allow all water to drain from tailpiece. The drain saddle valve must be installed above (before) the trap. It should be mounted with the opening on the top of horizontal drain pipe to avoid drain gurgling noise. If this is not possible, it can be installed on a vertical section of the drain pipe before the trap. For basement installations, route drain line through an air gap to laundry sink, floor drain or stand pipe.

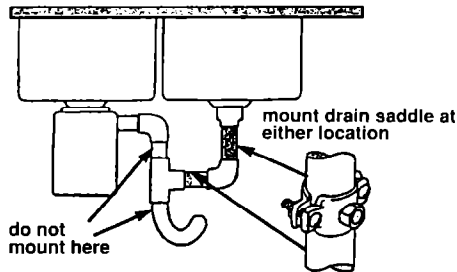

4b. Inspect the condition of the sink drain pipe. Replace any trap or tailpiece that is in poor condition. Water from the RO system drain line must flow into a suitable drain. The black tubing from the faucet must flow downward to the drain.

! CAUTION

Property/Product Damage

DO NOT install drain saddle assembly to:

- a tailpiece used as a garbage disposal outlet.
- the bottom of a horizontal section of tailpiece.

Failure to follow these instructions could result in plugging of filtration system drain line.

4c. The drain saddle assembly is designed to fit a standard 1½" O.D. tailpiece. Smaller or larger tailpiece piping will require a special drain saddle assembly available from your local plumbing supply distributor. Position both halves of the drain saddle on the tailpiece. Insert bolts in drain saddle and tighten evenly and firmly. Check that both halves of drain saddle are parallel and equally spaced.

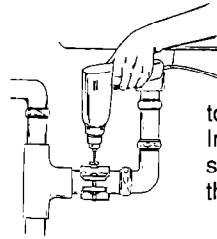
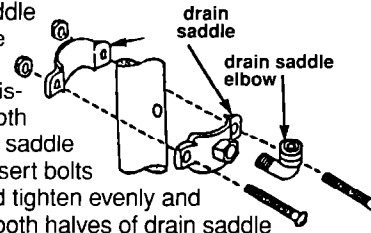

4d. You will need a grounded electric drill or hand drill and a ¼" drill bit to drill a hole in the drain pipe. Insert drill bit into opening of drain saddle. Operate drill slowly to drill through one side of drain pipe.

4e. Thread elbow into drain saddle. Tighten elbow as far as it will go.

! CAUTION

Product Damage

The black tubing from the faucet must slope downward without loops or low spots to the drain saddle.

Failure to follow this instruction could result in excessive drain noise.

4f. Run black tubing to drain saddle. Check that tubing slopes continuously downward from faucet without loops or low spots. Cut black tubing to shortest length possible, make sure end of tubing is clean and blunt and tubing is round. Push black tubing into push-in connector on drain saddle elbow as far as it will go.

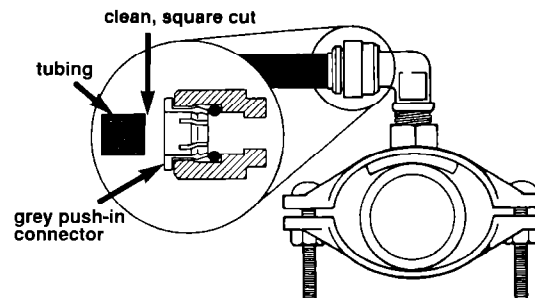

Flush System

Instructions At A Glance • For detailed instructions see following page.

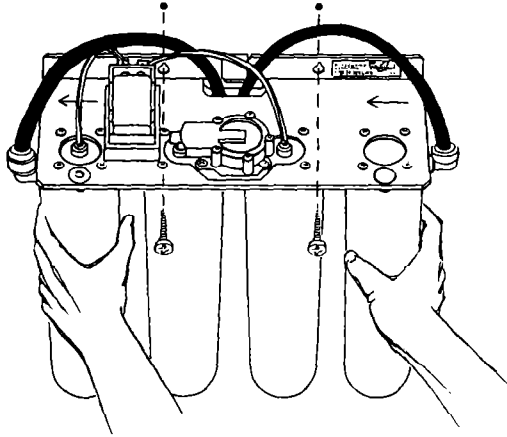

1. Slide filtration assembly onto mounting screws. (Step 5a)

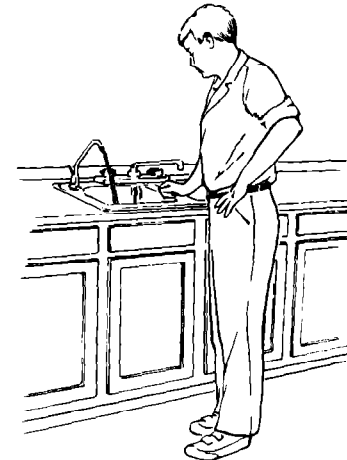

2. Turn on faucet and drain tank to flush disinfectant from tank. (Step 5b)

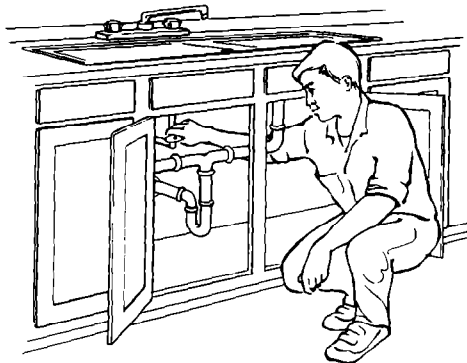

3. Turn on cold water supply and saddle valve. (Step 5c)

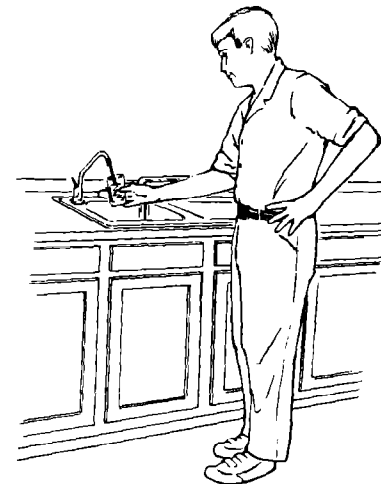

4. Allow tank to fill – approximately 4 hours. Lift faucet handle to drain tank. Fill and drain tank again – another 4 hours. Wait for tank to fill again. When faucet is turned on, green indicator light will indicate water is ready for use. (Steps 5d-5e)

Flush System

5a. Slide filtration assembly mounting holes onto mounting screws that were installed in step 3b. DO NOT kink or bend tubing. Insulated staples may be used to secure tubing to cabinet walls. Tighten mounting screws to secure filtration assembly to wall. Replace filtration assembly cover.

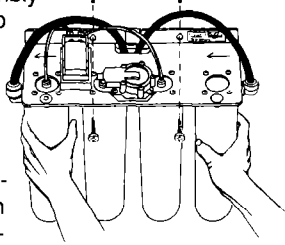

5b. In step 3h you filled the storage tank with water to activate the special disinfectant. If that water has set in the tank for at least 15 minutes, you can now drain the tank. To do this, turn the storage tank's blue valve on (up). Lift the faucet handle and allow tank to completely drain. Close faucet. **Important:** The storage tank must be filled and drained two more times before the water is suitable for use.

5c. Turn on cold water supply and saddle valve. Check for leaks. (If the saddle valve leaks, refer to "General Tips" on page 14 to make necessary corrections.) Lift faucet handle until a short but steady stream of water flows – this can take about 15-20 minutes. Water may intermittently spurt out from faucet opening if air is trapped in the system. This is not a problem.

5d. Close faucet handle and allow tank to fill. Since the tank is now connected to the filtration system it will take about 4 hours to fill. DO NOT use this water. Turn on faucet and drain tank. Close faucet and refill tank, wait at least 4 hours and drain system again. DO NOT use this water. It may contain some disinfectant solution. Disregard indicator lights at this time. When storage tank is emptied for the third time, the sanitizing agent is completely flushed from tank. The faucet will steadily drip when faucet is on. Check that there is a steady drip from faucet.

5e. The system should be ready to use as soon as the tank refills (about 4 hours), and the indicator disk's light turns green when the faucet is turned on. If any objectionable taste is present after the third draining, or if the light is yellow, wait four more hours and drain the tank again. As soon as the tank refills, taste the water. If it has a taste you may want to drain and fill the tank again. If water tastes okay, the system is ready for use. When the faucet is turned on, the indicator light should now be green.

5f. Congratulations!

General Information

- Water will not flow immediately from the faucet after installation. The Reverse Osmosis process is not immediate and it may take up to four hours to fill the storage tank.
- After installation, completely drain the system twice to remove sanitizing agent used during manufacturing. The green light on the indicator disk will light up when the sanitizing agent has been flushed out of the system.
- The flow rate from this system's water faucet is dependent upon the amount of tubing used in installation and the water pressure in your home.
- DO NOT install this water filtration system outside of the home.
- **Maintenance of this water filtration system is very important.** Replace the Sediment (S), GAC Carbon (GAC) and Carbon Block (CB) cartridges annually. Replace the TFCM Membrane (RO) Cartridge when the indicator disk light turns yellow. Failure to maintain this water filtration system over an extended period of time could present health risks.

Use & Care Information

Water Requirements

The filtration system must be connected to a cold water supply line providing 40-100 psi water pressure. If psi is less than 40, a booster pump, (Part Number 4373525) will be needed.

Review the water application guideline chart below to determine if your water meets the standards necessary to use this water filtration system.

! WARNING

DO NOT use filtration system if water is microbiologically unsafe or water quality is unknown. Pretreat water that exceeds limits for hardness, iron, manganese, and hydrogen sulfide.

Failure to follow these instructions could result in personal injury.

Application Guideline Chart

Water Supply Parameters

Water Supply- community or private well	Potable (suitable for drinking)	Chemical	Limit
		hardness	< 350 mg/L
Water Pressure	40-100 psi	iron	< 0.1 mg/L
Water Temperature	40°-100°F	manganese	< 0.05 mg/L
pH Range	4-11	hydrogen sulfide	0
Maximum TDS Level	2000 ppm	turbidity	<1 NTU

General Tips

- For best performance of system, drain tank completely once a week.
- To correct a leaky saddle valve, turn off cold water supply and make sure saddle clamp screws are tightened evenly and firmly. DO NOT overtighten, you could crush the pipe. Then make sure the nut below the saddle valve's handle is tight. If not, tighten it with a $\frac{7}{8}$ " wrench.
- If the drain saddle leaks, it may not be tightly clamped. Tighten the bolts on both sides evenly and firmly.
- If the drain saddle elbow leaks, the connection may be loose. Remove the elbow, wrap Teflon tape around the threaded portion 2-4 times. Reinsert the elbow into the drain saddle opening and tighten. DO NOT overtighten.

- If the threaded portion of the brass compression nut that is attached to the saddle valve leaks, turn off saddle valve and remove the nut, wrap Teflon tape around the threaded portion 2-4 times. Reconnect the nut.
- If a leak should occur at a push-in connector, the cause is usually defective tubing. To correct the problem turn off water supply to the RO system either at the saddle valve or other existing water valve. Push in the grey push-in connector and hold; then pull the tubing out of the connector. Cut at least $\frac{1}{4}$ " from the end of the tubing using a plastic tubing cutter or a sharp razor knife. Make sure the cut end is clean and blunt and that tubing is round. Reinsert tubing as far as it will go. Turn on water supply at valve.
- If a cartridge head leaks, it may have a misaligned, pinched or damaged O-ring. Shut off the saddle valve and tank valve. Open the faucet until dripping stops (5 minutes minimum). Turn filter cartridge $\frac{1}{4}$ turn to the left and remove. Replace the O-ring if it is misaligned, pinched or damaged.
- If the spout leaks when faucet is closed, it is either because of an obstructed or defective valve seat in the faucet or because the tee-bar under the handle is not adjusted correctly. To check for obstruction, turn and lift valve spout to remove. Slide faucet handle forward over spout hole. Unscrew tee-bar and slotted bushing from faucet valve. Remove faucet valve and check for obstruction. Replace valve, Part No. 4373522, if necessary. To adjust the tee-bar, complete steps to check obstruction and then raise the tee-bar.
- If there is no steady drip from the open faucet when tank is drained, confirm that your cold water valve is fully open. Confirm that the water saddle valve needle pierced pipe and is fully open. Correct any leaks. Wait for any trapped air to leave system. If the system was connected to a refrigerator ice maker, the ice maker valve may have been opened before installation was completed. Turn the ice maker off and wait until faucet drips.
- There are four things to check if the air gap opening is leaking:
 1. Blocked or improperly drilled drain line – clear drain line, remove drain saddle and check for hole.
 2. Air lock in gap outlet – blow air into air gap using a short tube.
 3. Excessive drain flow – disconnect red tubing from faucet air gap inlet tube. Check that drain flow is less than 175 ml ($\frac{3}{4}$ cup) per minute. If not, replace red tubing with tubing of proper length available from your Whirlpool dealer.
 4. Black drain tubing plugged – remove blockage in black drain tubing. Replace tubing if necessary.

- If you experience too little or no drain flow, the red tubing may be plugged or defective – replace red tubing with tubing of proper length available from your Whirlpool dealer. Confirm that the water saddle valve is fully open. Check for obstructions in the faucet air gap by removing the air gap and inspecting the flow path – replace faucet if necessary. The Sediment or GAC cartridges may be clogged – replace if necessary.
- If you detect chlorine or unpleasant tastes or odors at startup, there may still be some sanitizing agent in the tank. Drain and fill tank two to three times.
- If you hear gurgling or dribbling sounds in the drain, check that $\frac{3}{8}$ " black drain tubing from faucet slopes downward to drain saddle. Angle drain piping so drain water runs down side of pipe. Or, change location of drain saddle to horizontal drain pipe or alternate vertical drain pipe farther from trap. Important: Make sure drain saddle is installed before (above) trap. If a garbage disposal is present, the water may be dripping off the edge of the baffle. Rotate the vertical drain pipe above the baffle so the filtration system drain hole enters the pipe on the opposite side.
- If the water has a bad taste after filter cartridges are changed, the storage tank needs to be sanitized. Order Tank Sanitizing Kit Part No. 4373527 and follow "How to sanitize RO system" instructions.

How your RO water filtration system works

Your RO water filtration system uses reverse osmosis to help purify your water. When you use the system, water is first filtered through a 5-micron filter to remove particles 10 times smaller than your eye can see. The water moves to the next cartridge and is forced through granular activated carbon to remove chlorine and taste-or-odor-causing compounds. The third cartridge filters water through a reverse osmosis membrane to reduce metals, salts and large organic molecules when the faucet is turned on. Then the water flows into the storage tank where it is ready to use. The last (fourth) cartridge filters water from the tank again through an activated carbon filter to remove any small organic molecules and tastes that may still remain in the water.

RO system production rate is 10.3 gallons per day at 50 PSI, 77°F and 715 mg/L NaCl.

Use this system only with water that has nitrate levels limited to influent concentration of 30 mg/L or less. Use the nitrate test kit provided with system to test nitrate level of your water.

Using your RO water filtration system

To get purified water from the storage tank – Hold the faucet handle down for momentary flow, hold the faucet up for continuous flow.

To stop water flow from the faucet – Return the faucet to the center or horizontal position.

When faucet flow slows or drips – The storage tank is empty. Wait 1 hour before dispensing any additional water.

Ways purified water can be used – Your water filtration system has many uses, including:

- Drinking water
- Cooking water
- Ice cubes
- Mixing baby formula
- Watering plants
- Pet drinking water
- Steam irons
- Aquarium
- Hand washing dishes

Maintaining your RO water system

How often RO Membrane, Sediment and Carbon cartridges need to be replaced will depend on local water conditions including dirt, iron and chlorine levels. Private wells may require more frequent cartridge replacement while softened water systems may only require cartridge replacement once a year. The maximum length of time a filter cartridge should be used is one year. Special water conditions where contaminants are known should be regularly monitored by a public health agency.

The RO membrane filter cartridge should be replaced when indicator light changes from green to yellow. The maximum length of time a RO membrane filter cartridge should be used is three years.

Cartridge	Replace at least	Or replace if or when...
Sediment (1st on right)	Once/year	<ul style="list-style-type: none"> • Water supply is cloudy has high dirt and rust content (change every six months) • Water amount or flow from faucet is noticeably reduced
Carbon (2nd from right)	Once/year	<ul style="list-style-type: none"> • Water supply smells of chlorine or water has high dirt and rust content (change every six months)
RO membrane (3rd from right)	Once every 2 years	<ul style="list-style-type: none"> • Indicator light changes from green to yellow, even after draining tank twice
Carbon Block (4th from right)	Once/year	<ul style="list-style-type: none"> • Water has "off" taste or odor

Maintenance of this water filtration system is very important.

Replace the Sediment (S), GAC Carbon (GAC) and Carbon Block (CB) cartridges annually. Replace the TFCM Membrane (RO) cartridge when the indicator disk light turns yellow. Failure to maintain this water filtration system over an extended period of time could present health risks.

Replacing filter cartridges—Sediment and Carbon cartridges

1. Turn off water supply to RO system either at the saddle valve or cold water valve. Open faucet to drain tank. Wait five minutes for filtration assembly to depressurize.

2. Lift cover off of filtration assembly. Rotate cartridge ¼ turn to the left to remove connector tabs from receptacle. Gently pull down to remove cartridge.

3. Check that label on new cartridge matches label above cartridge receptacle. Remove red cap from cartridge. Wet O-ring seals of new cartridge with a little water. Line up the tabs at the top of the new cartridge with the slots in the filtration assembly's receptacle. Push cartridge up and turn it ¼ turn to the right to lock it into place. Cartridge label must face front. Pull down on cartridge to make sure it's firmly in place. Repeat step if cartridge disconnects.

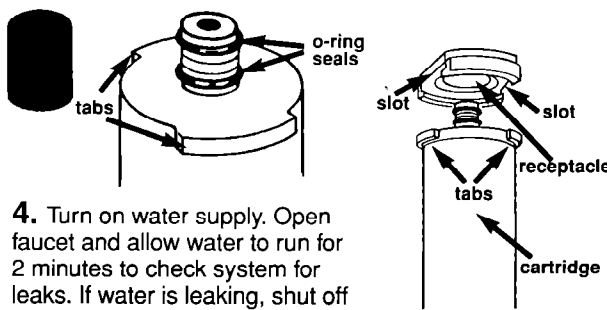
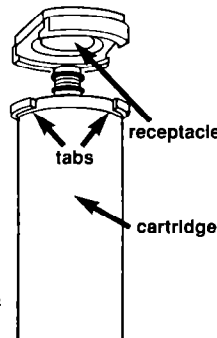

4. Turn on water supply. Open faucet and allow water to run for 2 minutes to check system for leaks. If water is leaking, shut off water and recheck connections. Replace cover.

Replacing RO membrane cartridge

1. When indicator light changes from green to yellow, turn off water supply, open faucet to drain tank and turn off saddle valve. Wait five minutes for filtration assembly to depressurize.

2. Lift cover off of filtration assembly. Push in the grey push-in connector near bottom of RO cartridge and remove tubing.

3. Rotate bad RO cartridge ¼ turn to the left to remove connector tabs from receptacle. Gently pull down to remove cartridge.

4. Remove RO membrane cartridge from plastic bag. Hold the RO cartridge over the sink. Push in the grey push-in connector and hold; then pull short white plug out of connector and discard.

5. Remove red cap from top of new RO cartridge. Allow preservative from cartridge to drain into sink. Rinse off the cartridge with tap water and dry with a paper towel. Wet O-ring seals with a little water. Reinsert red tubing into push-in connector of new RO cartridge.

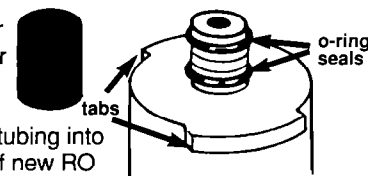

6. Line up the tabs at the top of the RO cartridge with the slots in the filtration assembly's receptacle. Push cartridge up and turn it ¼ turn to the right to lock it into place. Cartridge label must face front. Pull down on cartridge to make sure it's firmly in place. Repeat step if filter disconnects.

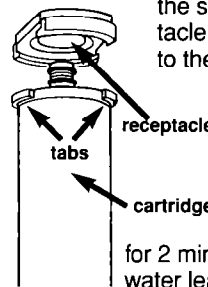

7. Turn on water supply. Open faucet and allow water to run for 2 minutes to check system for leaks. If water leaks, shut off water and recheck connections. Replace cover.

How to sanitize RO system

You will need new Sediment and Granular Activated Carbon cartridges, household bleach and eyedropper.

1. Turn off saddle valve in water line. Open faucet and drain tank. There will be no water dripping when tank is completely empty.

2. Remove Sediment and Granular Activated Carbon cartridges.

3. Remove caps from new cartridges. Insert new Sediment cartridge into receptacle with symbol that matches the one on label.

4. Use eyedropper to inject 1 teaspoon (5ml) of bleach into hole in top of new Granular Activated Carbon cartridge. Insert cartridge into receptacle with symbol that matches the one on label.

5. Turn on saddle valve in water line. Wait 6 hours before using system. Open faucet and drain tank. There will be water dripping when tank is empty. Allow tank to refill. If water has a taste, drain tank and allow it to refill again.

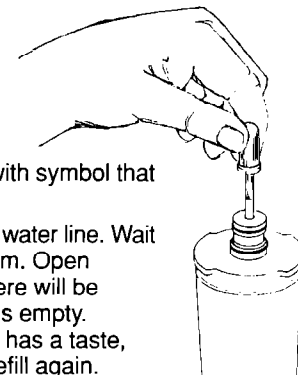

How to sanitize the storage tank

You will need to order Tank Sanitizing Kit, Part No. 4373527. You will also need household bleach and a measuring spoon.

1. Turn off saddle valve in water line. Open faucet and drain storage tank. There will be no water dripping when tank is empty.
2. Turn off faucet. Push in grey connector to disconnect yellow tubing from system. Connect yellow tubing to push in connector on side of sanitizing kit.

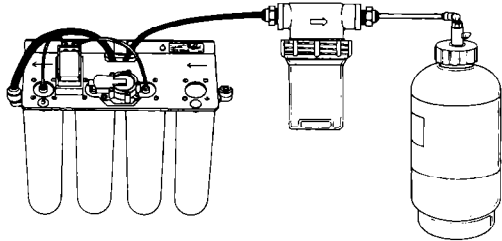

3. Disconnect orange tubing from filtration assembly. Connect orange tubing to tank sanitizing kit's other push-in connector.
4. Put ½ teaspoon of bleach into tank sanitizing kit.
5. Turn on saddle valve in water line. Allow storage tank to fill for about 3 minutes. Turn off saddle valve in water line and the valve at the top of storage tank.
6. Wait 15 minutes. Disconnect tank sanitizing kit from storage tank. Disconnect the orange tubing from the tank sanitizing kit.
7. Reconnect orange tubing to filtration assembly. Reconnect yellow tubing to filtration system.
8. Turn on saddle valve in water line and the valve at top of storage tank. Open faucet and drain tank. There will be water dripping when the tank is empty.
9. Allow tank to refill. Wait about 6 hours. Drain tank again and allow it to refill. If water has a taste, drain tank and allow it to refill again.

Preparation for long periods of non-use

Follow these instructions if RO system will not be used for more than 30 days.

1. Turn off saddle valve in water line. Open faucet to drain tank. There will be no water dripping when tank is completely empty. Wait five minutes for filtration assembly to depressurize.
2. Remove all cartridges. Place cartridges upside-down in sink or bucket to drain water from cartridges. Place cartridges in a plastic bag and seal tightly. Place bag with cartridges in refrigerator. **DO NOT allow cartridges to freeze.**

Using RO system after long periods of non-use

1. Follow instructions for replacing cartridges.
2. Sanitize storage tank.
3. Sanitize RO System.
4. Follow "Flush System" instructions.

If You Need Assistance...

The Whirlpool Consumer Assistance Center will answer any questions about operating or maintaining your RO water filtration system not covered in the Installation Instructions/Use and Care Guide. The Whirlpool Consumer Assistance Center is open 24 hours a day, 7 days a week. Just dial **1-800-253-1301** – the call is free.

When you call, you will need the RO water filtration system model number and serial number. Both numbers can be found labeled on the top right side of the filtration assembly.

How To Arrange For Service...

In the event that your Whirlpool appliance should ever need service, call the dealer from whom you purchased the appliance or a Whirlpool-authorized service company. A Whirlpool-authorized service company is listed in the Yellow Pages of your telephone directory under "Appliances—Major—Service or Repair." You can also obtain the service company's name and telephone number by dialing, free within the continental United States, the Whirlpool Consumer Assistance Center telephone number, **1-800-253-1301**. A special operator will tell you the name and number of your nearest Whirlpool-authorized service company.

Maintain the quality built into your Whirlpool appliance – call a Whirlpool-authorized service company.

Call 1-800-253-1301 to order.

Replacement Parts & Accessories

Replacement Cartridge Kit Kit includes Sediment (S), GAC Carbon (GAC) and Carbon Block (CB) Cartridges. Cartridges can also be ordered individually. TFCM Membrane Cartridge (RO) needs replacing only once every two years, when indicator disk light turns yellow.	4373575
TFCM Membrane Cartridge (RO)	4373501
Sediment Cartridge (S)	4373502
GAC Carbon Cartridge (GAC)	4373503
Carbon Block Cartridge (CB)	4373504
SFC Flow Control (Red Tubing)	4373508
Filtration Assembly Cover	4373509
Storage Tank	4373511
Air Gap Faucet	4373522
Refrigerator Hook-up Kit	4373505
Additional Parts Needed For Multiple Connections:	¾" Tubing 4319151 "T" Connector with Push-in Ends 4319152
% Rejection Monitor	4373512
Flow Sensor	4373513
LED Faucet Base Assembly	4373514
Installation Instructions	4373500B
Installation Kit	4373518
Tubing Kit	4373519
¼" Green Tubing 4'	4373516
Spare "O" Ring Kit	4374515
Drain Saddle Assembly	4373520
Saddle Valve, Self-tapping	4373521
Basement Installation Kit	4373517
Booster Pump	4373525
Tank Sanitizing Kit	4373527
¾ Connector with Push-in Ends	4373546
¾ "T" Connector with Push-in Ends	4373547
¾-¼ Male Connector with Push-in Ends	4373548
¾-¼ Reducing Connector with Push-in Ends	4373549
¼ Elbow Connector with Push-in Ends	4373556
¾ Elbow Connector with Push-in Ends	4373557



MODEL IV REVERSE OSMOSIS DRINKING WATER TREATMENT UNIT
MODEL NO. WSR413YW

REPLACEMENT CARTRIDGE: WHIRLPOOL RO FSP# 4373501 WHIRLPOOL S FSP# 4373502
WHIRLPOOL GAC FSP# 4373503 WHIRLPOOL CB FSP# 4373504

SERVICE FLOW RATE – 0.6 gpm (2.28 lpm)
MAX. OPERATING PRESSURE – 100 psig (862 kPa)
MIN. OPERATING PRESSURE – 40 psig (345 kPa)
MAX. OPERATING TEMPERATURE 100°F (38°C)

NOTICE: DO NOT USE WHERE WATER IS MICROBIOLOGICALLY UNSAFE OR WITH WATER OF UNKNOWN QUALITY. THIS PRODUCT HAS BEEN TESTED AND LISTED UNDER NSF STANDARD 58 FOR TOTAL DISSOLVED SOLIDS, ARSENIC, BARIUM, CADMIUM, CHROMIUM, NITRATE, LEAD, MERCURY, RADIUM, AND SELENIUM REDUCTION. SEE PERFORMANCE DATA SHEET FOR PERMISSIBLE CLAIMS.

NITRATE REDUCTION MODELS ("NITRATE") ARE ACCEPTABLE FOR TREATMENT OF INFLUENT CONCENTRATIONS UP TO 30 mg/L; ADDITIONAL TREATMENT SHALL BE REQUIRED FOR HIGHER INFLUENT LEVELS.

THIS SYSTEM IS NOT CERTIFIED FOR NITRATE REDUCTION IN WATER SUPPLIES WITH A PRESSURE OF LESS THAN 40 PSI.

WHIRLPOOL CORPORATION, BENTON HARBOR, MI, USA.

IT IS ESSENTIAL THAT OPERATIONAL, MAINTENANCE AND FILTER REPLACEMENT REQUIREMENTS BE CARRIED OUT FOR THE PRODUCT TO PERFORM AS ADVERTISED.-

NSF®

Performance Data Sheet



This Reverse Osmosis System has been tested and listed by NSF International under Standard 58 for the water treatment claims listed below under "Contaminant Reduction Performance".

Whirlpool Reverse Osmosis Water Filtration System IV Model No. WSR413YW

Contaminant Reduction Performance ⁴	Influent (ave. mg/L)	Effluent (ave. mg/L)	Effluent (max. mg/L)	Min. % Rej.	EPA ¹ MCL
Arsenic	0.28	0.029	0.05	90%	0.05
Barium ²	10.0	0.01	0.03	99%	2.0
Cadmium ²	0.032	0.0001	0.0004	99%	0.005
Chromium (Hexavalent) ²	0.16	0.006	0.02	96%	0.1
Chromium (Trivalent) ²	0.14	0.002	0.002	99%	0.1
Fluoride	8.8	0.26	0.37	97%	4.0
Lead	0.22	0.002	0.008	99%	0.015
Mercury	0.0054	0.0005	0.0016	91%	0.002
Nitrate	29.0	1.69	4.6	94%	10
Radium 226/228 ³	25 pCi/L	5 pCi/L	5 pCi/L	80%	5 pCi/L
Selenium	0.098	0.001	0.007	99%	0.05

Test Parameters

TDS = 200-500 mg/L² pH = 7.5 Turbidity = 1 NTU Temperature = 77°F Pressure = 50 psig

¹USEPA Maximum Contaminant Level or Action Level (mg/L).

²Barium, Cadmium and Chromium were tested at 750 mg/L TDS.

³The reduction of Radium was verified by using Barium as a surrogate under NSF protocol.

⁴These contaminants are not necessarily in your water supply. Performance may vary based on local water conditions.

In addition to the contaminants listed above, these systems also have the ability to effectively reduce non health-related chemicals like Chlorides, Phosphate, Sodium and Sulfates.

APPLICATION GUIDELINES/SPECIFICATIONS AND FEATURES

Membrane Type	TFCM	Water Supply Parameters	
Water Supply—Community or Private Well	Chlorinated Only	Chemical Hardness	Limit <350 mg/L
Water Pressure	40-100 psi (3-7 Kg/cm ²)	Iron	<0.1 mg/L
Water Temperature	40°-100°F (4.4 - 38°C)	Manganese	<0.05 mg/L
pH Range	4-11	Hydrogen Sulfide	0
Maximum TDS Level	2000 ppm	Turbidity	<1 NTU

CAUTION: Do Not use where water is microbiologically unsafe or with water of unknown quality. Water supplies that exceed limits for Hardness, Iron, Manganese, Hydrogen Sulfide require pretreatment.

Important Quality Assurance Requirements

This Reverse Osmosis Drinking Water system contains treatment components that are critical for effective reduction of Total Dissolved Solids as well as inorganic contaminants. A water quality monitor (indicator light disk) is built into the system to provide the user with a means to test the water at any time. Refer to "Use and Care Information" for operation of the water quality monitor (indicator light disk).

Routine Maintenance

Sediment Prefilter, Carbon Prefilter and Carbon Postfilter: Change once per year*

Membrane: Change as required based on the built-in water quality monitor.

*Refer to "Use and Care Information" for additional conditions.

Purification Assembly Components	General Performance
Sediment Prefilter: 5 micron Nominal Depth Cartridge Carbon Prefilter: Activated Carbon Membrane Type: Thin Film Composite (TFCM) Carbon Postfilter: Activated Carbon	Testing Laboratory* System Production: 10.3 gal/day (39 liters/day) Minimum TDS Reduction: 96% *Rated at 50 psi, 77°F, 750 mg/L NaCl, product to storage tank.
Standard Tank Capacity: 2.6 Gallons maximum. Factory sanitized and ready to install. Reject Water: This drinking water appliance has a self cleaning feature that requires approximately 3 gallons of rinse water for every gallon of high quality water used.	Factory Specifications** Membrane Production: 14-20 gal/day High-Flow Membrane Membrane TDS Reduction: 96% Minimum **Rated at 60 psi, 77°F, 350+ mg/L TDS, product to atmosphere. Note: Actual production rate and TDS reduction will depend upon temperature, water pressure, TDS level, membrane variation and usage pattern.
All Drinking Water Appliances are factory tested, sanitized and prepared for installation.	

WARRANTY

Length of Warranty:

Whirlpool will pay for:

One Year Full Warranty (from date of purchase)

Replacement parts and repair labor to correct defects in materials or workmanship for the entire product except for the filter cartridge(s). Servicing must be provided by an authorized Whirlpool servicing outlet.

Five Year Limited Warranty (second through fifth year from date of purchase)

Replacement parts to correct defects in materials or workmanship for the entire product except for the filter cartridge(s).

Whirlpool will not pay for:

A. Service calls to:

- 1.) Correct the installation of the product. System must be installed and operated in accordance with Whirlpool procedures and guidelines.
- 2.) Instruct you how to use the product.
- 3.) Correct house plumbing.

B. Repairs when product is used in other than normal, single-family household use.

C. Repairs when product is damaged from neglect, misuse, abuse, freezing or hot water, fouling with sediment or scale, bacterial attack, alterations, improper installation, or installation not in accordance with local plumbing codes.

D. Any labor costs during the limited warranty.

E. Replacement parts or repair labor costs for units operated outside the U.S.

F. Pickup and delivery. This product is designed to be repaired in the home.

G. Repairs to parts or systems caused by unauthorized modifications made to the product.

The performance and functioning of your water filtration system is directly related to the quality of the water being treated and the particular application in which it is used. Please consult "Water Requirements" and "Use & Care".

Whirlpool shall not be liable for incidental or consequential damages. Some states do not allow the exclusion or limitation of incidental or consequential damages, so this limitation or exclusion may not apply to you.

This warranty gives you specific legal rights, and you may also have other rights which vary from state to state.

Part No. 4373500 Rev B
©1993 Whirlpool Corporation



Whirlpool Corporation
Benton Harbor, MI 49022



Printed on Recycled Paper in U.S.A.