

use & care guide

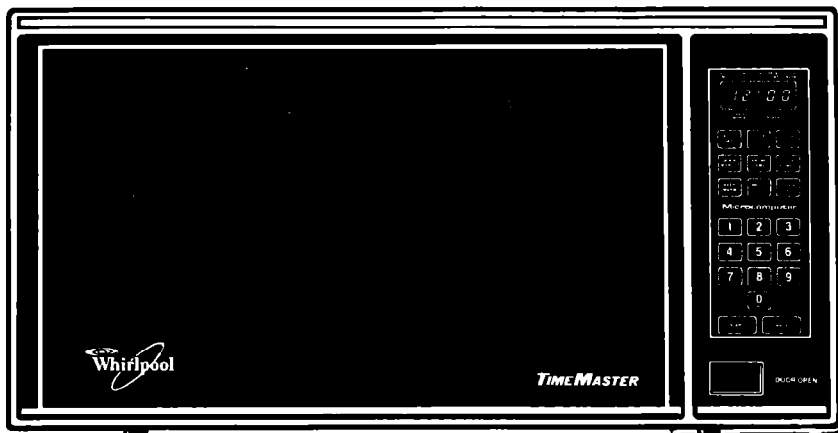

**MICROWAVE
OVEN**

The Whirlpool logo, consisting of a stylized swirl above the word "Whirlpool" in a serif font, all set against a black rectangular background.

Model MW3600XS

Freezers, Refrigerator-Freezers, Ice Makers, Dishwashers, Built-In Ovens and Surface Units, Ranges, Microwave Ovens, Trash Compactors, Room Air Conditioners, Dehumidifiers

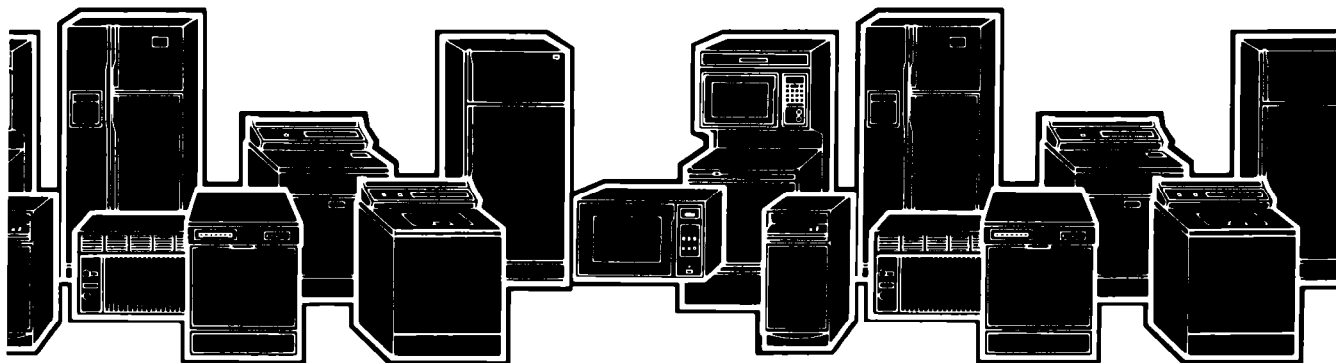

Contents

	Page		Page
Parts and Features	2	Cooking in More Than One Cycle	13
Before You Install Your Microwave Oven		Cooking with the Temperature Probe ..	15
Before You Use Your Microwave Oven	3	Using PAUSE	18
Precautions to Avoid Possible Exposure to Excessive Microwave Energy	3	Using KEEP WARM	19
Important Safety Instructions	4	Minute Timer	20
Using Your Microwave Oven	5	Delayed Start	21
Microwave Oven Controls	5	Other Operating Hints	22
Programming Tone	6	Bi-Level Cooking Rack	23
Setting the Clock	6	Installation Instructions	24
Cooking in Your Microwave Oven	6	Grounding Instructions	25
Cook in One Cycle	7	Custom Mounting the Microwave Oven	26
High Cook Power	7	Caring for Your Microwave Oven	26
Lower Cook Powers	8	Cleaning the Microwave Oven	26
Using AUTO SET	9	How Your Microwave Oven Works	27
Defrosting	11	Operating Safety Precautions	28
		If You Need Service or Assistance	28

©1986 Whirlpool Corporation

Parts and features

Model MW3600XS

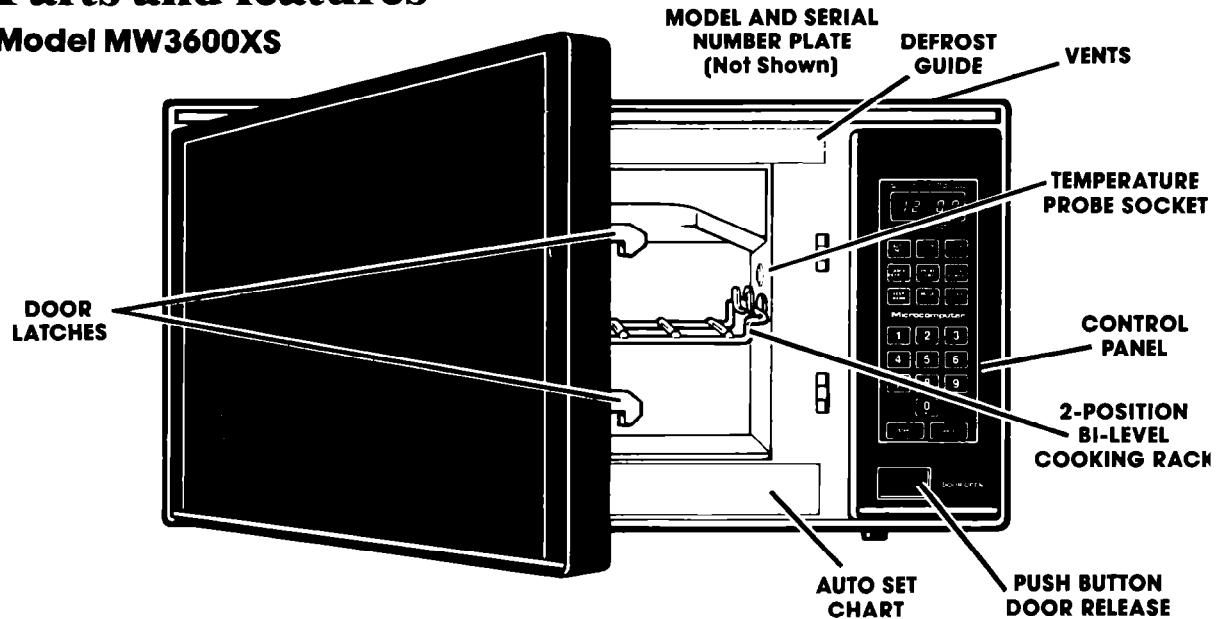

Copy your Model and Serial Numbers here...

If you need service or call with a question, have this information ready:

- 1. Complete Model and Serial Numbers** (from the plate just behind the microwave oven door on the oven frame).
- 2. Purchase date** from sales slip.

Copy this information in these spaces. Keep this book, your warranty and sales slip together in a handy place. **Please complete and mail the Owner Registration Card** furnished with this product.

Model Number

Serial Number

Purchase Date

Service Company Phone Number

Fill out and return the "Microwave Registration Card" Included with your oven. If the card is missing, please send the model number of your microwave oven with your name and address to...

Whirlpool Corporation
Microwave Registration Department
Administrative Center
2000 U.S. 33 North
Benton Harbor, Michigan 49022

This information will help us reach you if there is ever a need to pass along information about your microwave oven.

Before you install your microwave oven

Read and carefully follow the "INSTALLATION INSTRUCTIONS" found on page 24 of this "Use & Care Guide."

Before you use your microwave oven

Read this "Use & Care Guide" carefully for important use and safety information. Store in a convenient place for future use.



It is your personal responsibility and obligation to be sure your microwave oven:

- Has been installed where it is protected from the elements. **The microwave oven should be at a temperature above 50°F (10°C) for proper operation.**
- Has been installed on a surface strong enough to support its weight.
- Has been properly connected to electrical supply and grounded. (See "Installation Instructions.")
- Is not used by anyone unable to operate it properly.
- Is properly maintained.
- Is used only for jobs expected of a home microwave oven.

PRECAUTIONS TO AVOID POSSIBLE EXPOSURE TO EXCESSIVE MICROWAVE ENERGY.

DO NOT attempt to operate this oven with the door open since open-door operation can result in harmful exposure to microwave energy. It is important not to defeat or tamper with the safety interlocks.

DO NOT place any object between the oven front face and the door or allow soil or cleaner residue to accumulate on the sealing surfaces.

DO NOT operate the oven if it is damaged. It is particularly important that the oven door close properly and that there is no damage to the

- (1) Door (bent),
- (2) Hinges and latches (broken or loosened),
- (3) Door seals and sealing surfaces.

DO NOT operate the microwave oven if the door window is broken.

The microwave oven should be checked for microwave leakage by qualified service personnel after a repair is made.

The oven should not be adjusted or repaired by anyone except properly qualified service personnel.

DO NOT operate the microwave oven with the outer cabinet removed.

IMPORTANT SAFETY INSTRUCTION

Microwave ovens have been used successfully in homes for a number of years. They are thoroughly tested for safe and efficient operation. However, as with any appliance, there are special installation and safety precautions which must be followed to ensure safe and satisfactory operation and prevent damage to the unit.



WARNING – To reduce the risk of burns, electric shock, fire, injury to persons or exposure to excessive microwave energy:

1. Read all instructions before using appliance.
2. Read and follow the specific **“PRECAUTIONS TO AVOID POSSIBLE EXPOSURE TO EXCESSIVE MICROWAVE ENERGY”** found on page 3.
3. This appliance must be grounded. Connect only to properly grounded outlet. See **“GROUNDING INSTRUCTIONS”** found on page 25.
4. Install or locate this appliance only in accordance with the provided **“INSTALLATION INSTRUCTIONS”** found on page 24.
5. Some products such as whole eggs and sealed containers – for example, closed glass jars – may explode and should not be heated in this oven.
6. Use this appliance only for its intended use as described in this manual.
7. As with any appliance, close supervision is necessary when used by children.
8. Do not operate this appliance if it has a damaged cord or plug, if it is not working properly, or if it has been damaged or dropped. Electric shock, fire or other hazards may result.
9. This appliance should be serviced only by qualified service personnel. Call a Whirlpool authorized TECH-CARE® Service Company for examination, repair or adjustment.
10. Do not cover or block any opening on the appliance, for fire may result.
11. Do not use outdoors for damage to the oven or electric shock may result.
12. Do not immerse cord or plug in water for electric shock may result.
13. Keep cord away from heated surfaces for electric shock may result.
14. Do not let cord hang over edge of table or counter for electric shock may result.
15. See door surface cleaning instructions on page 26.
16. To reduce the risk of fire or fire in the oven cavity:
 - a. Do not overcook food. Carefully attend appliance if paper, plastic, or other combustible materials are placed inside the oven to facilitate cooking. Paper can char or burn, and some plastics can melt if used when heating foods.
 - b. Test dinnerware or cookware before using. See page 30. Some dishes (melamine, Centura,® etc.) absorb microwave energy, becoming too hot to handle and slowing cooking times. Remove wire twist-ties from paper or plastic bags before placing bag in oven. Cooking in metal containers can damage the oven. So can containers with hidden metal (twist-ties, foil lining, staples, metallic glaze or trim.)
 - c. If materials inside the oven should ignite, keep oven door closed, turn oven off, and disconnect the power cord, or shut off power at the fuse or circuit breaker panel.
17. Read and follow **“OPERATING SAFETY PRECAUTIONS”** starting on page 28.

SAVE THESE INSTRUCTIONS

Using your microwave oven

Microwave oven controls

- There are three parts in the control section:
- Digital Display/Clock, and Indicator Lights
 - Command Pads
 - Number Pads

Instructions for each control are covered on the following pages. Read them carefully.

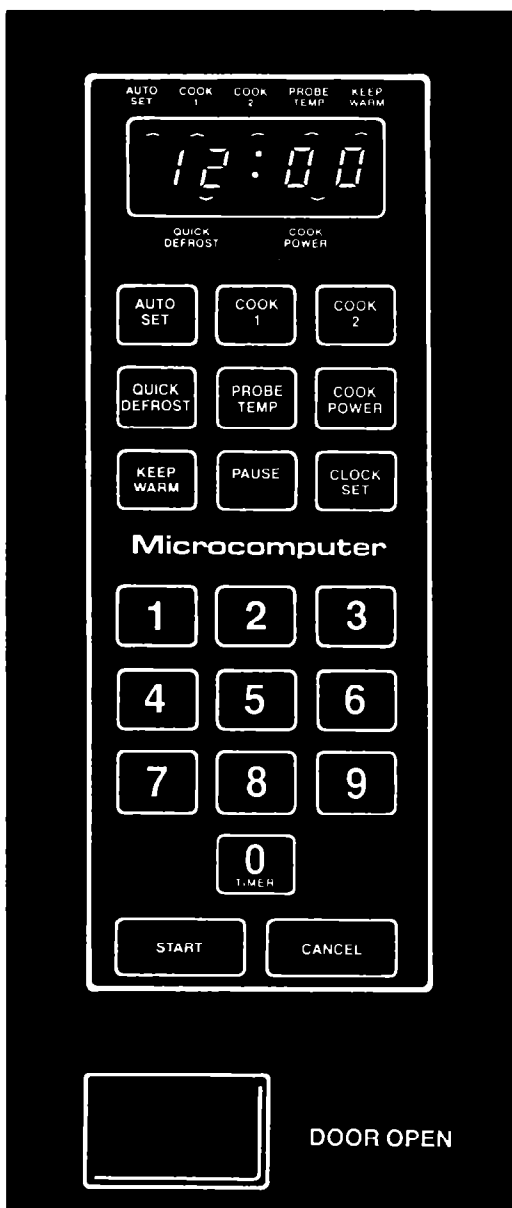

When you first plug in the oven, a tone sounds and the Display will show **88:88**. If after you set the Clock (page 6), the Display again shows all 8's, it means your electricity was off for a while. Reset the Clock.

Digital display/clock and indicator lights



When you are not using the microwave oven, this is an accurate digital clock. When you are using the microwave oven, it displays time settings, indicator lights and shows what number pads you touched.

Command pads



Touch Command Pads to tell the microwave oven what to do and in what order. A few examples:

- **CLOCK SET** tells the oven you are going to set the clock.
- **START** tells the oven to start.

See page 6 for information on the tone you hear when touching any pad.

Each Command Pad (except **START**, **CANCEL**, and **CLOCK SET**) lights an Indicator Light when you touch the Command Pad.

While the oven is running, an Indicator Light (or lights) will be on to show what the oven is doing.

Number pads

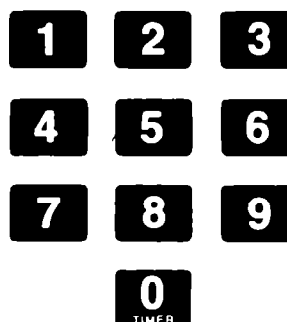

Once you've touched a Command Pad to tell the oven what you want it to do, you'll touch Number Pads to tell it...

- a time,
- a Cook Power,
- a food temperature.

Programming tone

Each time you touch a pad you will hear a tone. If you don't hear a tone, it is because the instruction is not correct, or because the tones have been removed.

EXAMPLE: If you touch a Number Pad before you touch a Command Pad, you will not hear a tone. The instruction is not correct.

If you want to remove the programming tone:

- Open the door.
- Touch CANCEL **twice**, then touch START.
- The tone will not sound for any touch.

If you want to replace the programming tone:

- Open the door.
- Touch CANCEL **twice**, then touch START.
- The tone will sound for any correct touch.

If you want to remove all tones, except the minute timer signal:

- Open the door.
- Touch CANCEL **twice**, touch 0, then touch START.
- All audible tones will be cancelled.
- **To replace the tones**, repeat the above steps.

Setting the clock

When the oven is first plugged in, one beep will sound and the Display shows **88:88**. If the electric power ever goes off, the Display will again show all 8's when the power comes back on.

You can cook without setting the clock, but the Display will be blank after cooking.

DO THIS...

THIS HAPPENS...



1. Touch **CLOCK SET**.



The Display will show a "0" and the colon will start to flash. **The first Number Pad must be touched within 5 seconds or the Display will go blank.** Touch **CLOCK SET** again and continue.



2. Touch Number Pads for the correct time of day.



The Display will show what numbers you touched **in the order you touched them**. This example shows 3:25.



3. Touch **START**.



The colon will stop flashing. The Clock is set.

If you have touched in an incorrect time, such as 12:65, "Err" will show on the Display. Touch **CLOCK SET** and start over.

NOTE: To reset the clock, touch **CLOCK SET**. The current time will show on the Display and the colon will flash. Set the clock as shown above.

Cooking in your microwave oven

Be sure to read the **MICRO MENUS® Cookbook** packed with the microwave oven. It contains information about:

- What microwave energy is.
- How food is cooked by microwave energy.
- What affects cooking speed and cooking evenness.
- Safety tips.
- Utensils to use when cooking in a microwave oven.
- Cooking times for different foods.

Important things to remember to get the best cooking results.

- ALWAYS cook food for the minimum recommended cooking time. If necessary, add time in one or two minute periods, then check for doneness to avoid overcooking the food.
- Stir, turn or rearrange the food being cooked about halfway through the cooking time for most even doneness with all recipes.
- If a glass cover is not available, use waxpaper, paper towels or microwave approved plastic wrap. Turn back a corner to vent steam during cooking.

Cooking in one cycle

Follow these steps to cook at **high power**.

DO THIS...

THIS HAPPENS...

- 1. Put food in the oven and close the door.**



- 2. Touch COOK 1.**



The COOK 1 Indicator Light will come on and the Display will show four 0's



- 3. Touch Number Pads for the cooking time you want.**

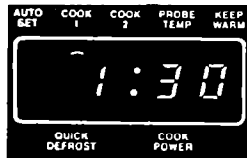

The Display will show the numbers you touched **in the order you touched them**. The example shows 1 minute, 30 seconds.



- 4. Touch START.**

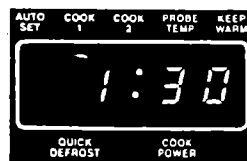

The oven will automatically cook at high Cook Power.

The COOK 1 Indicator Light will stay on to show that the oven is cooking in the first cycle.

count
down



BEEP BEEP BEEP BEEP

The Display counts down the time to show how much time is left in the first cycle.

When the cooking time ends, "End" will show on the Display and 4 beeps will sound. (You can stop the beeping by opening the door or by touching CANCEL.) "End" will remain on the Display and a beep will sound every 30 seconds (to remind you that food is left in the oven) until door is opened or CANCEL is touched. The Display will then show the time of day.

Changing the cooking time

Cooking time can be changed any time before touching START or during the cycle:

1. Touch COOK 1.
2. Touch numbers for the new time.
3. Touch START.

Cook 1 will continue cooking for the new time.

Lower cook powers

For best results, some recipes call for lower Cook Powers. The lower the Cook Power, the slower the cooking. Each Number Pad also stands for a different percentage of Cook Power. Many recipes in your MICRO MENU[®] Cookbook tell you, by number, which Cook Power to use. Recipes in other books and magazines may tell you by name (HI, MED, LO, etc.) or percentage (10%, 50%, 80%, etc.).

The following chart gives the percentage of Cook Power each Number Pad stands for, and Cook Power name usually used.

automatic	100% of full power	HIGH	4	= 40% of full power
9	= 90% of full power		3	= 30% of full power MED-LOW
8	= 80% of full power		2	= 20% of full power
7	= 70% of full power	MED-HIGH	1	= 10% of full power LOW
6	= 60% of full power		0	= TIMER (fan and light will be off)
5	= 50% of full power	MED		

DO THIS...

THIS HAPPENS...

1. Put food in the oven and close the door.



2. Touch COOK 1.



The COOK 1 Indicator Light will come on and the Display will show four 0's.



3. Touch Number Pads for the cooking time you want.



The Display will show the numbers you touched **in the order you touched them**. This example shows 7 minutes, 30 seconds.



4. Touch COOK POWER.

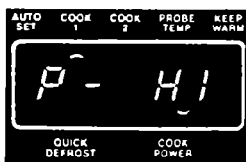

The COOK POWER Indicator Light will come on and the Display will show "P-HI". This shows the oven is pre-programmed to cook at full (HIGH) power.



5. Touch a Number Pad for the Cook Power you want.



The Display will show what you touched. This example shows you touched Number Pad 5 for 50% of full power.

START

6. Touch START.



The COOK 1 and COOK POWER Indicator Lights will stay on to show that the oven is cooking in the first cycle at a Cook Power other than high.

count
down

The Display counts down the time to show how much cooking time is left in the first cycle.



For 2 of every 10 seconds, the Display will show the Cook Power you selected.



BEEP BEEP BEEP BEEP

When the cooking time ends, "End" will show on the Display and 4 beeps will sound. (You can stop the beeping by opening the door or by touching CANCEL.) "End" will remain on the Display and a beep will sound every 30 seconds (to remind you that food is left in the oven) until door is opened or CANCEL is touched. The Display will then show the time of day.

Changing cook power

The **Cook Power** can be changed any time before touching START or during the cycle.

- Touch COOK POWER.
- Touch a number for the new Cook Power.
- Touch START. The cycle will cook at the new Cook Power for the original time.

OR..

- Touch COOK POWER **twice** if you want to change a lower Cook Power to HIGH.
- Touch START.

Using AUTO SET

Auto Set provides ten preset times. One to nine minutes at HIGH cook power can be set by touching AUTO SET and the corresponding number pad 1-9. This provides a short-cut method for setting commonly used cooking times.

The AUTO SET chart included with your microwave oven and the AUTO SET guide on the inner door panel helps you cook various food items without having to look up the cooking times.

A preset time of 2 minutes, 30 seconds at HIGH cook power is available by touching just the AUTO SET pad. The time may be changed to any time from 0-99 minutes, 0-99 seconds allowing you to store your favorite cooking time and Cook Power. See page 11 for instructions.

DO THIS...

THIS HAPPENS...

- 1. Put food in the oven and close the door.**

continued on next page

AUTO SET

2. Touch **AUTO SET**.
(Option: Skip to step 6 if you want to use the preset cooking time and Cook Power.)

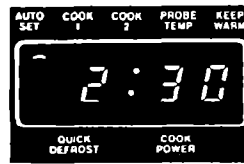

The **AUTO SET** Indicator Light will come on and the Display will show 2 minutes, 30 seconds (or the time you have set as your favorite cycle).

4

3. Touch a **Number Pad** for the new cooking time you want from 1 to 9 minutes.

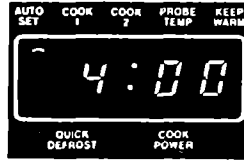

The Display will show what you touched in even minutes. This example shows 4 minutes.

COOK POWER

4. Touch **COOK POWER**.
(Option: Skip to Step 6 if you want to cook at high power.)

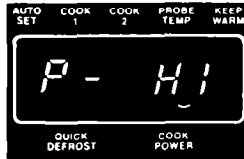

The **COOK POWER** Indicator Light will come on and the Display will show "P-HI."

5

5. Touch a **Number Pad** for the Cook Power you want.



The Display will show what you touched. This example shows you touched Number Pad 5 for 50% of full power.

START

6. Touch **START**.



The **AUTO SET** Indicator Light will stay on while the oven is cooking in the pre-programmed cycle. If you selected a Cook Power other than high, the Cook Power Indicator Light will also come on.

The Display counts down the time to show how much cooking time is left.

For 2 of every 10 seconds, the Display will show the Cook Power you selected, if you are using a Cook Power other than high.

When Auto Set ends, "End" will show on the Display and 4 beeps will sound. (You can stop the beeping by opening the door or by touching CANCEL.) "End" will remain on the Display and a beep will sound every 30 seconds (to remind you that food is left in the oven) until the door is opened or CANCEL is touched. The Display will then show the time of day.

count
down



End

BEEP BEEP BEEP BEEP

NOTE: You can set **COOK 1** or **COOK 2** to follow Auto Set, (See page 13, 14 and 15 for instructions).

Changing the pre-programmed setting

You can change the pre-programmed cooking time and Cook Power in AUTO SET to the time and power you most often use. To change the AUTO SET setting, follow these steps.

1. Place food in the oven and close the door.
2. Touch AUTO SET twice.
3. Touch the Number Pads for the new desired cooking time. If high Cook Power is desired, skip to Step 6.
4. Touch COOK POWER.
5. Touch the Number Pad for the desired Cook Power.
6. Touch START. The oven will cook at the new cooking time and Cook Power you selected. After the cooking is complete, the oven will remember that time and Cook Power for future use. **NOTE: If the electric power ever goes off, the oven will go back to the pre-programmed 2 minutes, 30 seconds at high Cook Power setting.**

Defrosting

Use QUICK DEFROST to thaw frozen food before cooking. For suggested defrost times, see the guide behind the oven door or the chart in your MICRO MENUS® Cookbook.

DO THIS...

THIS HAPPENS...

1. Put frozen food in the oven and close the door.

QUICK DEFROST

2. Touch QUICK DEFROST.



The QUICK DEFROST Indicator Light will come on and the Display will show four 0's.

2 3 0
TIMER

3. Touch Number Pads for the defrosting time you want.



The Display will show the number you touched **in the order you touched them**. This example shows 2 minutes, 30 seconds.

START

4. Touch START.



The QUICK DEFROST Indicator Light will stay on to show that the oven is in the Quick Defrost Cycle.

The Display counts down the time to show how much defrosting time is left.

End
BEEP BEEP BEEP BEEP

When the defrost time ends, "End" will show on the Display and 4 beeps will sound. (You can stop the beeping by opening the door or by touching CANCEL.) "End" will remain on the Display and a beep will sound every 30 seconds (to remind you that food is in the oven) until door is opened or CANCEL is touched. The Display will then show the time of day.

Using PAUSE with QUICK DEFROST

If the defrosting instructions call for stirring or turning of the food in the middle of defrost cycle, program PAUSE after QUICK DEFROST. Half way through the defrost cycle a beep will sound, "PAUS" will show on the Display and the oven will stop defrosting. After stirring or turning the food, touch START to continue the defrost cycle.

Standing time or cooking automatically after defrosting

For best results, allow the food to stand for a while after defrosting. This helps equalize the temperature of the food to provide more even defrosting.

When COOK 1 follows QUICK DEFROST, the oven automatically provides a standing time equal to the time touched in for QUICK DEFROST. COOK 1 will begin after the automatic standing time. There is no standing time between QUICK DEFROST and COOK 2 or QUICK DEFROST and KEEP WARM.

For cooking automatically after defrosting:

1. Touch QUICK DEFROST and desired time.
2. Touch COOK 1.
3. Touch numbers for desired cooking time.
4. Touch COOK POWER. (If you want to cook at high power, skip to step 6.)
5. Touch a number for desired Cook Power.
6. Touch START.

For a different standing time:

1. Touch QUICK DEFROST and desired time.
2. Touch COOK 2.
3. Touch numbers for desired standing time.
4. Touch COOK POWER.
5. Touch "0" for zero Cook Power.
6. Touch START

When QUICK DEFROST is over, the oven will shut off. If Cook 1 has not been programmed, 2 beeps will sound and the Display will count down the time for Cook 2 at zero Cook Power. If Cook 1 has been programmed, the Display will count down and sound 2 beeps before Cook 1 will start. "End" will show on the Display and 4 beeps will sound when the standing time and cooking time is over.

About the "QUICK DEFROST" Cycle

The microwave oven automatically divides the time set for the QUICK DEFROST Cycle into three equal parts:

First part	80% of full Cook Power
Second part	50% of full Cook Power
Third part	20% of full Cook Power

This automatic step-down in Cook Power helps defrost food quickly and completely.

Changing or adding defrost time

You can change the defrosting time any time before or after touching START.

- Touch QUICK DEFROST.
- Touch numbers for new time.
- Touch START.

Any new time setting made while QUICK DEFROST is operating will continue the defrosting at only 20% of full power.

The best time to change the setting is near the end of the QUICK DEFROST Cycle.

- Open the door.
- Check the food with long-tined fork; if center area is hard frozen, set additional time.
Remember that standing time is necessary to complete defrosting.
- Close the door and touch START To continue the cycle if no additional time is needed.
OR...
- Touch in new instructions for additional defrosting time.

Cooking in more than one cycle at one or more cook powers

For best results, some recipes call for one Cook Power for certain length of time, and another Cook Power for another length of time. Your oven can be set to change from one to another automatically.

DO THIS... THIS HAPPENS...

- Put food in the oven and close the door.



- Touch COOK 1.



The COOK 1 Indicator Light will come on and the Display will show four 0's.



- Touch Number Pads for the cooking time you want in the first cycle.



The Display will show the numbers you touched **in the order you touched them**. This example shows 3 minutes, 25 seconds.



- Touch COOK POWER. (If you want the high Cook Power, skip to step 6.)

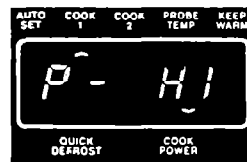

The COOK POWER Indicator Light will come on and the Display will show "P-HI". This shows the oven is pre-programmed to cook at full (HIGH) power.



- Touch a Number Pad for the Cook Power you want in the first cycle.



The Display will show what you touched. This example shows you touched Number Pad 6 for 60% of full power.



- Touch COOK 2.



The COOK 2 Indicator Light will come on and the Display will show four 0's.



- Touch Number Pads for the cooking time you want in the second cycle.



The Display will show the numbers you touched **in the order you touched them**. This example shows 4 minutes, 30 seconds.



- Touch COOK POWER. (If you want the high Cook Power, skip to step 10).

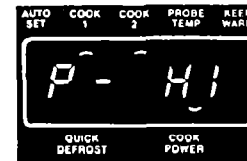

The COOK POWER Indicator Light will come on and the Display will show "P-HI". This shows the oven is pre-programmed to cook at full (HIGH) power.

continued on next page

4

9. Touch a Number Pad for the Cook Power you want in the second cycle.



The Display will show what you touched. This example shows you touched Number Pad 4 for 40% of full power.

START

10. Touch START.



When you touch START, the COOK 1 Indicator Light will stay on while the oven is cooking in the first cycle. The COOK POWER Indicator Light will be on if you are using a Cook Power other than high. All other Indicator Lights will go off.

count
down

The Display counts down the cooking time to show how much time is left in the first cycle.



For 2 of every 10 seconds, the Display will show the Cook Power you selected, if you are using a Cook Power other than high.

BEEP BEEP

You will hear 2 beeps at the end of Cook 1. You can either open the door to check, stir or turn the food, etc., or you can let the oven start the next cycle. If you do open the door, touch START after closing the door to restart the oven.



The COOK 2 Indicator Light will be on during the second cycle. The COOK POWER Indicator Light will also be on if you are using a Cook Power other than high.

count
down

The Display counts down the time the time to show how much time is left in the second cycle.



For 2 of every 10 seconds, the Display will show the Cook Power you selected, if you are using a Cook Power other than high.



BEEP BEEP BEEP BEEP

When Cook 2 ends, "End" will show on the Display and 4 beeps will sound. (You can stop the beeping by opening the door or by touching CANCEL.) "End" will remain on the Display and a beep will sound every 30 seconds (to remind you that food is left in the oven) until door is opened or CANCEL is touched. The Display will then show the time of day.

Hints for cooking with more than one cycle.

You can program the cooking cycles in any order. However, when the microwave oven is started, it will automatically go through the cycles in order – AUTO SET – COOK 1 – COOK 2 – PROBE TEMP – KEEP WARM or (QUICK DEFROST – STANDING TIME – COOK 1 – COOK 2 – PROBE TEMP – KEEP WARM)

If you want the oven to stop between cycles so that you can check food, add ingredients or additional food items, stir, turn, etc., you can program PAUSE between each Cook cycle. (See page 18).

Changing or adding instructions

You can change times, Cook Powers, or add cycles any time before touching START or during oven operation.

- Touch the Cook cycle you wish to change or add (COOK 1 or 2).
- Touch numbers for new time, if desired.
- Touch COOK POWER, if change is desired.
- Touch number for new Cook Power, or touch COOK POWER again if high is desired.
- Touch in new cycle and time, if desired.
- Touch START.

Cooking with the TEMPERATURE PROBE

The Temperature Probe helps take guesswork out of cooking roasts and larger casseroles. The probe is designed to turn off the oven when it senses the temperature you chose. See your MICRO MENUS® Cookbook for helpful information in cooking different types of food.

DO THIS...

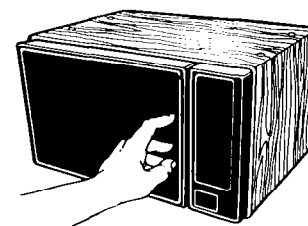
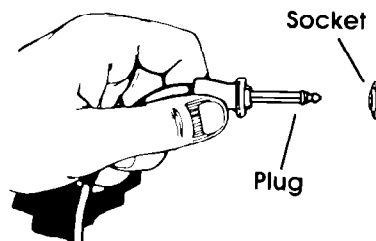
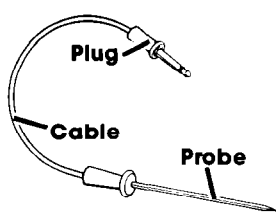

1. Insert at least 1/3 of the temperature probe into the food.

2. Place food in the oven and plug the probe into the socket on the oven wall.

3. Make sure the probe does not touch any part of the oven interior. Close the door.

DO THIS...

**PROBE
TEMP**

4. Touch PROBE TEMP.

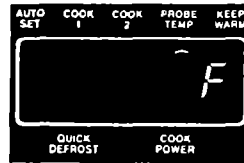

The PROBE TEMP Indicator Light will come on and the Display will show "F."



5. Touch Number Pads for the desired final temperatures between 90°F and 200°F.



The Display will show the numbers you touched **in the order you touched them**. This example shows a final cooked temperature of about 140°F.

**COOK
POWER**

6. Touch COOK POWER.
(Option: Touch START if you want to use high power.)



The COOK POWER Indicator Light will come on and the Display will show "P-HI." This shows the oven is pre-programmed to cook at full (HIGH) power.

6

7. Touch the Number Pad for the Cook Power you want.

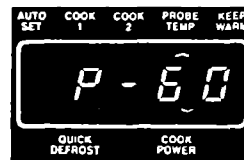

The Display will show what you touched. This example shows you touched Number Pad 6 for 60% of full power.

START

8. Touch START.



The PROBE TEMP and COOK POWER Indicator Lights will stay on. The Display will show "COOL" to show the food is less than 90°F. As the food cooks the Display will show the internal temperature of the food for every 5°F increase.



For 2 of every 10 seconds, the Display will show the Cook Power you selected, if you are using a Cook Power other than high.



When the probe senses the temperature you selected, the oven shuts off. "End" will show on the Display and 4 beeps will sound. (You can stop the beeping by opening the door or by touching CANCEL.) "End" will remain on the Display and a beep will sound every 30 seconds (to remind you that food is left in the oven) until door is opened or CANCEL is touched. The Display will then show the time of day.

BEEP BEEP BEEP BEEP

NOTE: "ERR" will be displayed after START is touched, if an incorrect temperature has been selected (under 90°F and over 200°F).

Hints for using the temperature probe

DO...

- use hot pads when removing probe from food or food from oven.
- stir foods during cooking when recommended.
- stir soups, casseroles and drinks before serving.
- cover roasts with foil and let stand a few minutes after cooking. Remove foil if you decide to cook it longer.
- remove the probe from the oven when not cooking by temperature.

DON'T...

- let probe or probe cable touch any part of the oven interior.
- let probe touch foil (if used). Foil can be kept away from probe with wooden toothpicks. Remove foil if arcing occurs.
- use paper, plastic wrap or plastic containers.
- use probe in regular oven.
- force probe into frozen food.
- use probe for foods that need to simmer.

NOTE: Some foods are started using a timed (COOK) cycle and finished by using the temperature (PROBE TEMP) cycle. You can set PROBE TEMP to follow COOK to avoid the need to reset the oven halfway through the cycle. PROBE TEMP can be programmed with the temperature probe out. The oven will pause between COOK and PROBE TEMP. "PROB" will show on the Display to remind you to plug in the probe.

Changing the temperature setting

When using the Temperature Probe, PROBE TEMP setting can be changed any time before touching START or during oven operation.

- Touch PROBE TEMP.
- Touch Number Pads for new temperature.
- Touch START. The oven will continue cooking to the new temperature. If the new temperature is lower than the temperature of the food, the oven will shut off.

Temperature probe cooking tips

For casseroles, the tip of the probe should be in the center of the food. Stir foods when recommended. Replace the probe.

For liquids, balance the probe on a wooden spoon or spatula so the tip of the probe is in the center of the liquid.

For roasts, the top of the probe should be in the center of the largest muscle, but not touching fat or bone.

- Casseroles cooked using the Temperature Probe should be made from precooked foods. Do not use raw meats, raw vegetables and cream sauces in casseroles.
- Dry casseroles do not work well.
- Thaw frozen casseroles and meats in the microwave oven before inserting the probe.
- If you are cooking individual servings such as mugs of soup, check the probe setting in several of the items – all mugs may not heat at the same rate.
- Dry meat loaf mixtures do not work well.
- Remember that roasts may vary in size, shape and composition. Use the timings for minutes per pound as a guide as well as the Temperature Probe.

Cleaning the probe

1. Remove probe from microwave oven using hot pads.
2. Wipe probe with a hot sudsy cloth. Use plastic scouring pad to remove stubborn foods.
3. Probe may be placed in the silverware basket of the dishwasher.

Using PAUSE

For best results, some recipes call for stirring, turning, or adding ingredients during cooking. Your microwave oven can be set to pause between COOK 1 and COOK 2, between any Cook cycle and PROB TEMP, between AUTO SET and a following cycle, between QUICK DEFROST and a following cycle (except COOK 1), or during QUICK DEFROST to give you time to stir or turn the food, or to add ingredients. PAUSE is not available between any cycle and KEEP WARM or after QUICK DEFROST.

DO THIS...

THIS HAPPENS...

1. Put food in the oven and close the oven door.

2. Touch in the desired cooking instructions for COOK 1, (page 13).



3. Touch PAUSE.



The COOK 1 Indicator Light will be on and the Display will show "PAUS"

4. Touch in the desired cooking instructions for COOK 2, (see page 14).



5. Touch START.



The Display will show the time you selected for Cook 1.

When Cook 1 is over, 2 beeps will sound and the oven will shut off. The Display will show "PAUS."



The COOK 2 Indicator Light will come on. The Display will show the time set for Cook 2.

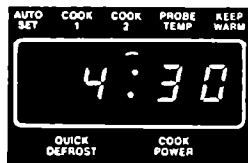

Open the door. Stir, turn or add ingredients. Close the door.

Touch START to continue with Cook 2. **The oven will remain off until you touch START.**

Using PAUSE with QUICK DEFROST

Your microwave oven can be set to pause halfway through QUICK DEFROST or to allow you to turn or rotate the food for more even defrosting.

1. Put frozen food in the oven and close the door.
2. Touch QUICK DEFROST.
3. Touch Number Pads for the defrosting time you want.
4. Touch PAUSE.
5. Touch START.

When half of the QUICK DEFROST time is remaining, you will hear 2 beeps and the oven will shut off.

6. Open the door. Turn or rotate the food being defrosted. Close the door.
7. Touch START to continue QUICK DEFROST.

NOTE: The oven will remain off until you touch START.

Adding "PAUSE"

PAUSE can be added to the cycle in operation, if there is to be another cycle.

- Touch PAUSE.
- Touch START.

The microwave oven will stop automatically. You will hear 2 beeps. START must be touched to continue.

Using KEEP WARM

Hot, cooked foods can be safely kept warm in your microwave oven for up to 99 minutes, 99 seconds (about 1 hour, 40 minutes). KEEP WARM can be used by itself, or it can automatically follow a cooking cycle.

DO THIS...

THIS HAPPENS...

1. Put cooked, hot food in oven and close door.



2. Touch KEEP WARM.



The KEEP WARM Indicator Light will come on. The Display will show the time of day.



3. Touch START.



The KEEP WARM Indicator Light will stay on. The oven light and the fan will come on. The Display will continue to show the time of day.

- KEEP WARM operates for up to 99 minutes, 99 seconds.
- Opening the oven door cancels KEEP WARM. Close the door and touch KEEP WARM, then START if additional KEEP WARM time is desired.
- Foods cooked covered should be covered during KEEP WARM.
- Pastry items (pies, turnovers, etc.) should be uncovered during KEEP WARM.
- Complete meals kept warm on a dinner plate should be covered during KEEP WARM.
- The use of more than one complete KEEP WARM (about 1 hour, 40 minutes) is not recommended. The quality of some foods will suffer with extended time.

To automatically follow another cycle

- **While you are touching in cooking instructions**, touch KEEP WARM before touching start, **OR...**
- **After the oven starts operating**, touch KEEP WARM and then START.
- When the last cooking cycle is over, you will hear 4 beeps. The KEEP WARM Indicator Light will come on and the time of day will be displayed while the oven continues to run.
- KEEP WARM will follow QUICK DEFROST, COOK 1, COOK 2, AUTO SET or PROBE TEMP.

Minute timer

The microwave oven controls can be used as a kitchen timer. Use COOK 1 at "0" Cook Power for timing up to 99 minutes, 99 seconds.

DO THIS...

THIS HAPPENS...



1. Touch COOK 1



The COOK 1 Indicator Light will come on and the Display will show four "0"s.



2. Touch Number Pads for the minutes and seconds you want.



The Display will show the numbers you touched **in the order you touched them**. This example shows 1 minute, 45 seconds.



3. Touch COOK POWER.



The COOK POWER Indicator Light will come on and the Display will show "P-HI".



4. Touch "0" Number Pad.

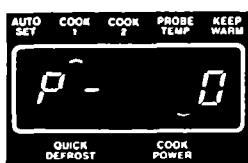

The Display will show "P-0". This tells you that the oven will be operating at 0% power.



5. Touch START.



The Cook 1 and Cook Power Indicator Lights will stay on to show you that the timer is running.

The Display counts down to show you how much time is left. During the countdown the oven will be dark and the fan will be off.

When the set time ends, "End" will show on the Display and 4 beeps will sound. (You can stop the beeping by opening the door or by touching CANCEL.) "End" will remain on the Display and a beep will sound every 30 seconds until door is opened or CANCEL is touched. The Display will then show the time of day.

If you hear the fan start when you touch START, you have not set the time properly. Touch CANCEL and start over.

End

BEEP BEEP BEEP BEEP

Opening the oven door stops the countdown. Close the door and touch START to continue the timing countdown.

Delayed start

The microwave oven can be set to start automatically at a later time. Use COOK 1 Cycle at "0" Cook Power to delay the start of COOK 2 for up to 99 minutes, 99 seconds.

DO THIS...

THIS HAPPENS...

1. Put in food and close the door. See CAUTION.



2. Touch COOK 1.



The COOK 1 Indicator Light will come on and the Display will show four "0"s.



3. Touch Number Pads for the length of delay you want.



The Display will show the numbers you touched **in the order you touched them**. This example shows 60 minutes (1 hour).



4. Touch COOK POWER.



The COOK POWER Indicator Light will come on and the Display will show "P-HI".



5. Touch "0" Number Pad.

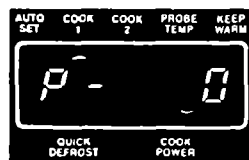

The Display will show "P-0". This tells you that the oven will be operating at 0% power.



6. Touch COOK 2.



The Cook 2 Indicator Light will come on and the Display will show four "0"s.

continued on next page

7. Touch in the cooking time and Cook Power.



8. Touch START.



The Indicator Lights and Display will show the same information as "Defrosting and cooking in two cycles" during operation. During the Cook 1 Cycle the oven will be off, but the Display will count down the set time.

Note: If you hear the fan start when you touch START; you have not set the oven properly. Touch CANCEL Pad and start over.

Extra Information:

- You can't touch in more than 99 minutes, 99 seconds of delay in the COOK 1 Cycle.
- If you open the door before the oven begins to cook, be sure to retouch START.

CAUTION:

Use foods that will not go bad or spoil while waiting for cooking to start. Avoid using with milk or eggs, cream soups, cooked meats, poultry or fish, or any item with baking powder or yeast.

Smoked or frozen meats may be used; so can vegetables, fruits and casserole-type foods.

Any food that has to wait for cooking to start should be very cold or frozen before it is put in the oven. MOST UNFROZEN FOODS SHOULD NEVER STAND AT ROOM TEMPERATURE MORE THAN TWO HOURS BEFORE COOKING STARTS.

Other operating hints

1. To double check settings while the oven is running:

- Touch the Command Pad for the setting you want to check. The instruction programmed for that pad will show on the display for 5 seconds. Then the display returns to showing what the oven is doing.

2. To stop the oven while it is running:

- Open the door. The oven will stop. Restart the oven by closing the door and touching START.
- Touch CANCEL. All instructions will be erased. You must touch in new instructions.

3. If you touch two instructions into the same cycle, the second set of instructions will cancel the first.

Bi-level cooking rack

Use the metal Bi-Level Cooking Rack when cooking in more than one container. The metal rack can be turned upside-down to help fit taller containers on the bottom of the oven.

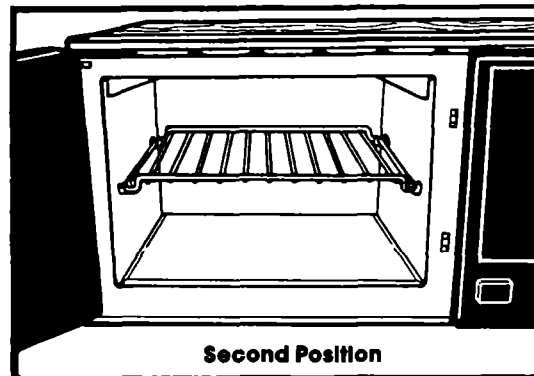
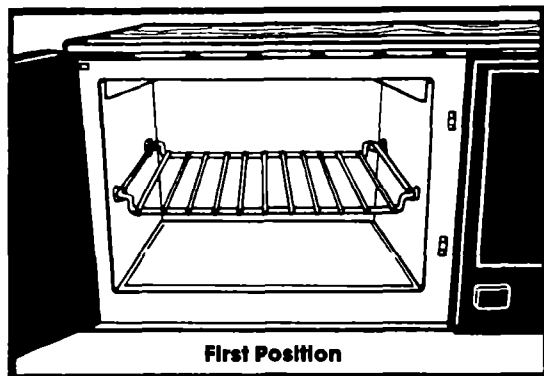

NOTE: Do not store the metal rack in the oven. Arcing and damage to the oven can result if someone accidentally starts the oven.

inserting the rack

- Insert the rack securely into the rack supports on the side wall of the oven. (First position)
- Turn rack upside-down when using a taller container on the bottom of the oven. (Second position)
- **Do not** operate the oven with the metal rack stored on the floor of the oven. Damage to the interior finish will result.

Cleaning the rack

- Wash by hand with a mild detergent and a soft nylon scrub brush. Dry completely.
- **Do not** use abrasive scrubbers or cleansers.

Special cautions

- **Do** use hot pads when removing rack from oven after cooking. It may be hot.
- **Do** put food in containers, then place containers on rack.
- **Do** use only when cooking foods in more than one container.
- **Do** use only in the microwave oven.
- **Do not use with browning dish.**
- **Do not** let food container touch top or side of the oven.
- **Do not store rack in oven.**
- **Do not** cook foods directly on rack without putting them in containers first.

Installation instructions

BEFORE YOU BEGIN, READ THE FOLLOWING INSTRUCTIONS COMPLETELY AND CAREFULLY.

Installing your microwave oven

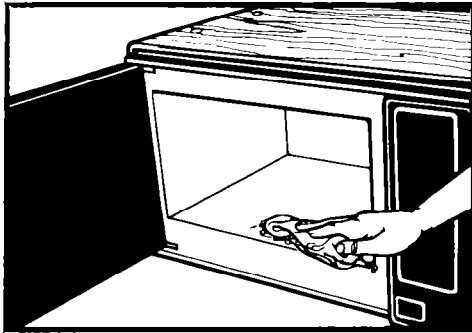

1. Empty the microwave oven and clean inside it with a soft, damp cloth. Check for damage such as misaligned door, damage around the door or dents inside the oven or on the exterior. If there is any damage, please do not operate the unit until it has been checked by an authorized Whirlpool service technician and any repairs made.

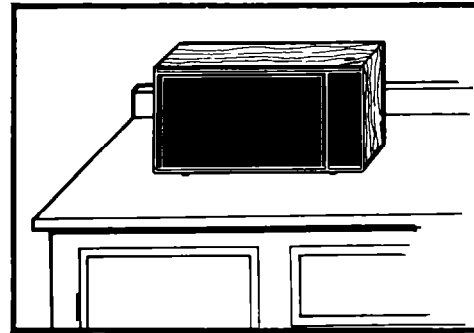

2. Put the oven on a cart, counter, table or shelf that is strong enough to hold the oven and the food and utensils you put in it. **(The control side of the unit is the heavy side. Use care when handling.)** The weight of the oven is approximately 43.5 lbs. (19.57 kg.).

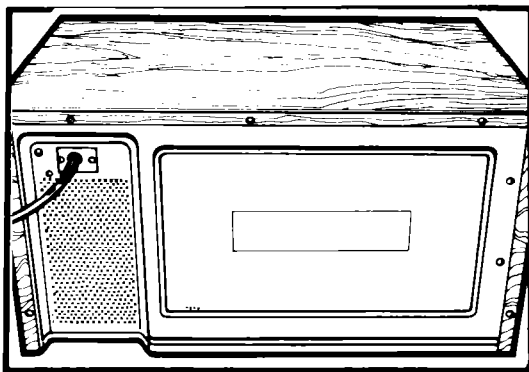

3. Do not block the front vent or rear air intake openings. Blocking vent or air intake openings can cause damage to the oven and poor cooking results. Make sure the microwave oven legs are in place to ensure proper air flow.

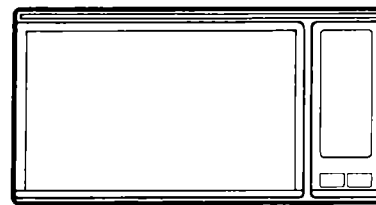

4. Do not install the oven next to a conventional surface unit or in any area where excessive heat and steam are generated. This could damage the outside of the cabinet.

5. Electrical requirements

Observe all governing codes and ordinances.

A 120 Volt, 60 Hz, AC only, 15 or 20 amp fused electrical supply is required (Time-delay fuse is recommended.) It is recommended that a separate circuit serving only this appliance be provided.

6. GROUNDING INSTRUCTIONS

WARNING: Improper use of the grounding plug can result in a risk of electrical shock.

DO NOT, UNDER ANY CIRCUMSTANCES, REMOVE THE POWER SUPPLY CORD GROUNDING PRONG.

7. For your personal safety, this appliance must be grounded. In the event of an electrical short circuit, grounding reduces the risk of electric shock by providing an escape wire for the electric current. This appliance is equipped with a

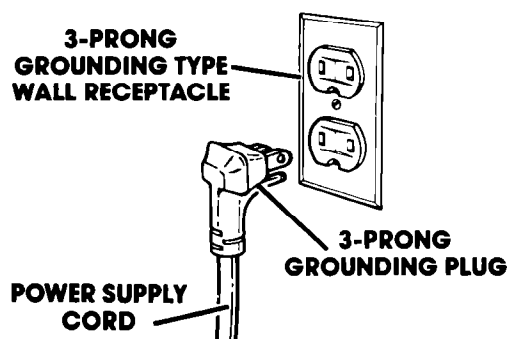

polarized 3-prong grounding plug. It must be plugged into a correctly polarized mating 3-prong grounding type wall receptacle, properly installed and grounded in accordance with the National Electrical Code and local codes and ordinances. If a mating wall receptacle is not available or if you are not sure if the

wall receptacle is properly grounded and polarized, have it checked by a qualified electrician.

It is the personal responsibility and obligation of the customer to have a properly grounded and correctly polarized 3-prong wall receptacle installed by a qualified electrician.

Consult a qualified electrician if the grounding instructions are not completely understood, or if doubt exists as to whether the appliance is properly grounded.

It is NOT recommended to use an extension cord with your microwave oven, but if you find it necessary to do so temporarily (until a properly grounded and polarized 3-prong receptacle is installed), use only a heavy duty UL listed 3 wire grounding type extension cord containing three 16 gauge (minimum) copper wires. It must not be longer than 10 feet (cords longer than 10 feet may affect the cooking performance of your microwave oven). The plug on the extension cord must fit into a 3-prong grounding type wall receptacle (as shown on this page) and the receptacle end of the extension cord must accept the 3-prong grounding plug of the microwave oven.



8. Plug the oven into the proper electrical outlet and put about one cup (250 mL) of cold water in a glass container in the oven. Close the door. Make sure it latches. Follow the directions on page 7 to set the oven to COOK for 2 minutes. When the time is up, the water should be heated.

9. This microwave oven is designed for use in the household only and must not be used for commercial purposes.

DO NOT remove the door, control panel, or cabinet at any time. The unit is equipped with high voltage and should not be serviced unless by an authorized Whirlpool trained service technician.

SAVE THESE INSTRUCTIONS

Custom mounting your microwave oven

Your microwave oven is not limited to carts, counters or tables. Custom installations are made easy with kits available from your dealer.

1. Attach the microwave oven to the wall.

4158015
Wall Mounting Kit

2. Attach the microwave oven directly to the underside of a cabinet.

4158000
Under-the-Cabinet Mounting Kit

3. Build the microwave oven directly into a wall or cabinet.

4158017
Built-In Kit

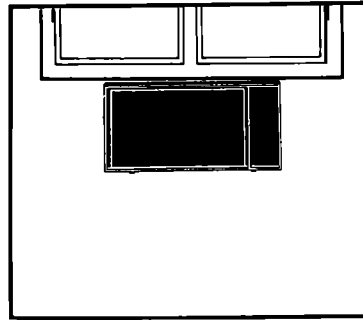

Do not install the oven next to or over a conventional surface unit or in any area where excessive heat and steam are generated. This could damage the microwave oven.

Caring for your microwave oven

Cleaning the microwave oven

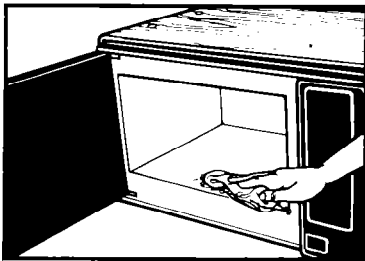

Wipe often with warm sudsy water and a soft cloth or sponge.

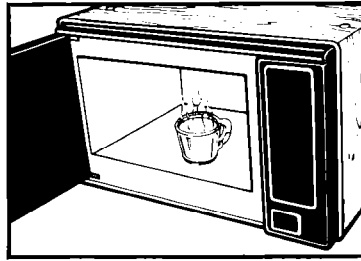

For stubborn soil, boil a cup of water in the oven for 2 or 3 minutes. Steam will soften the soil.

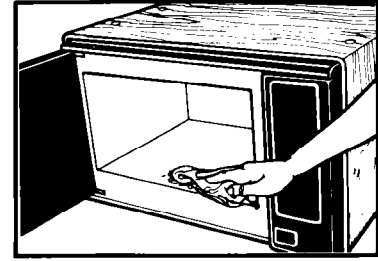

Be sure to clean the areas where the door and oven frame touch when closed. When cleaning surfaces of door and oven that come together on closing the door, use only mild, non-abrasive soaps or detergents applied with a sponge or soft cloth. Rinse well.

CAUTION:

Abrasive cleansers, steel wool pads, gritty wash cloths, etc., can damage the control panel, and the interior and exterior oven surfaces. Use a soft cloth or a sponge with a mild detergent or spray glass cleaner.

How your microwave oven works

Microwave ovens are safe. Microwave energy is not hot. It causes food to make its own heat, and it's this heat that cooks the food.

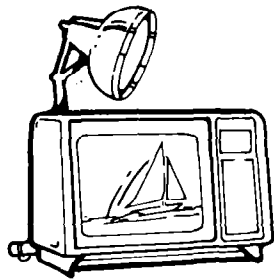

Microwaves are like TV waves or light waves. You can't see them, but you can see what they do.

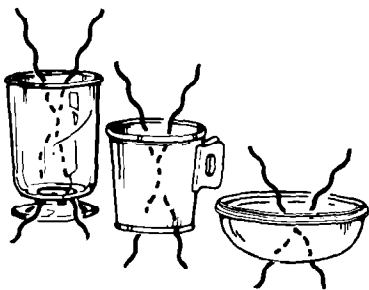

Microwaves pass through glass, paper and plastic without heating them so food absorbs the energy. Microwaves bounce off metal pans so food does not absorb the energy.

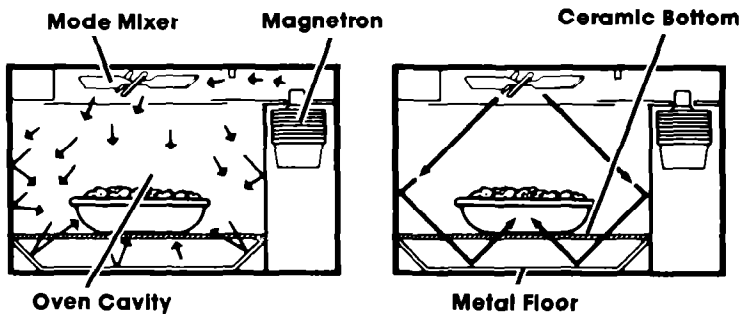

A magnetron in the microwave oven produces microwaves. The microwaves move into the oven where they are scattered or stirred by a mode mixer (like a fan). Microwaves bounce off metal oven walls and are absorbed by food.

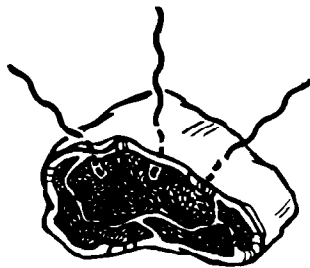

Microwaves may not reach the center of a roast. The heat around the outside is what cooks the roast all the way through. This is one of the reasons for letting some foods (roasts, baked potatoes) stand for a while after cooking, or for stirring some foods during the cooking time.



The microwaves disturb water molecules in the food. As the molecules bounce around bumping into each other, heat is made, like rubbing your hands together. This is the heat that cooks.

Operating safety precautions



WARNING: DO NOT use the oven until you have read and understand **ALL** the information on safe use.

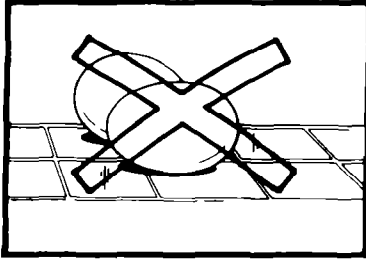

NEVER COOK OR REHEAT A WHOLE EGG.

Steam build-up in whole eggs may cause them to burst and burn you, and possibly damage the oven. Slice hard boiled eggs before heating. In rare instances, poached eggs have been known to explode. Cover poached eggs and allow a standing time of one minute before cutting into them.

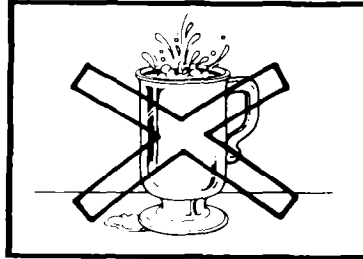

Liquids heated in certain containers (especially cylindrical-shaped containers) may become overheated. The liquid may splash out with a loud noise during or after heating or when adding ingredients (coffee, etc.) resulting in harm to the oven and possible personal injury. For best results stir any liquid several times before heating or reheating.

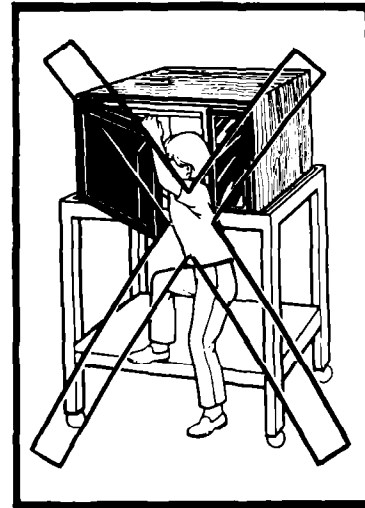

NEVER lean on the door or allow a child to swing on it when the door is open. Injury could result.

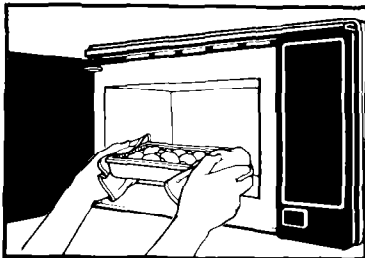

USE HOT PADS.

Microwave energy does not heat containers, but the hot food does. You could get burned.

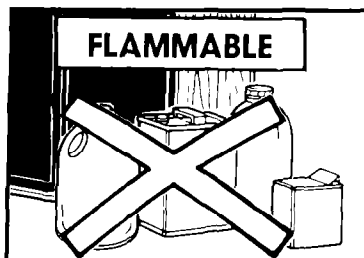

DO NOT heat, store or use flammable or inflammable materials in or near the oven.

DO NOT can foods in the oven. Closed glass jars may explode resulting in damage to the oven or possible personal injury.

DO NOT use the oven to sterilize objects (baby bottles, etc.). It is difficult to maintain the high temperature required for safe sterilization.

CAUTION: DO NOT use the oven until you have read and understood ALL precautions to prevent damage to the oven.

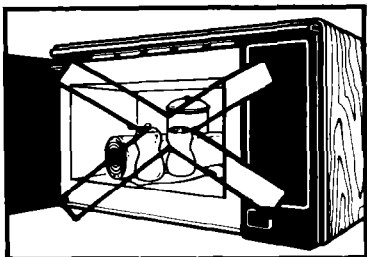

DO NOT use the oven for storage. Do not leave paper products, book or cooking utensils in the oven when not in use. Fire may result if someone accidentally starts the oven.

Don't let anything touch the top of the oven.

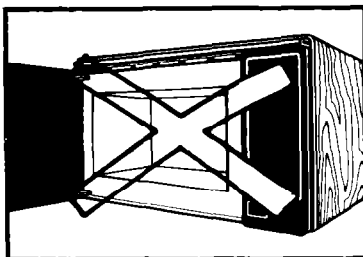

Starting a microwave oven when it's empty is not recommended. If you experiment, put a container of water in the oven.

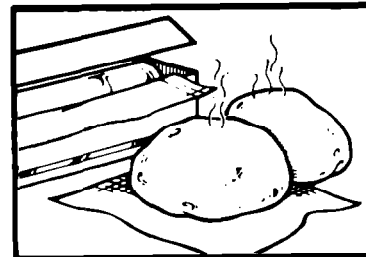

DO NOT OVERCOOK POTATOES. Fire could result. At the end of the recommended cooking time they should be slightly firm. Wrap in foil and set aside for 5 minutes. They will finish cooking while standing.

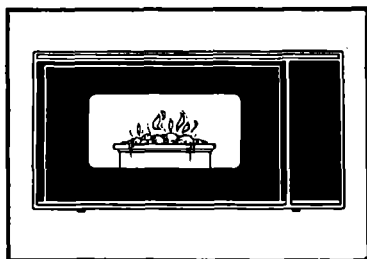

If a fire should start in the oven cavity:

- **keep door closed**
- **turn oven off**
- **disconnect the power supply** at the cord, fuse or circuit breaker.

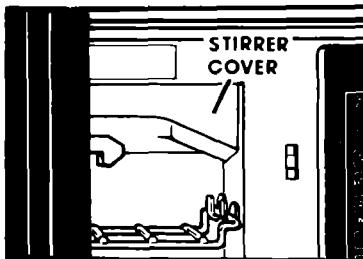

NEVER remove the stirrer cover. The plastic cover protects the microwave stirrer blade from soil or bending.

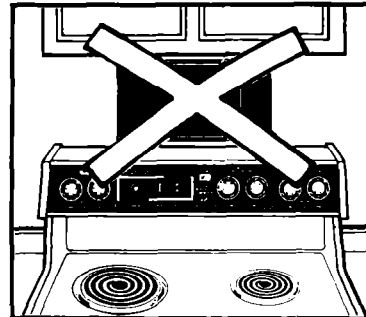

DO NOT mount this oven over a cooktop or range. Damage to the oven may result.

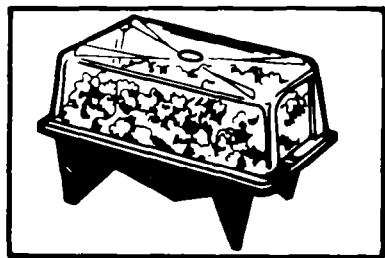

DO NOT pop popcorn, except in a microwave-approved popcorn popper or commercial package designed especially for microwave ovens. Results are the manufacturers responsibility.

NEVER try to pop corn in a paper bag. Overcooking may result in smoke and fire.

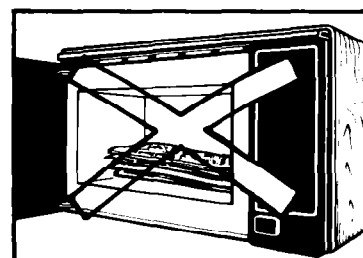

DO NOT use newspaper or other printed paper in the oven. Fire could result.

DO NOT dry flowers, fruit, herbs, wood, paper, gourds or clothes in the oven. Fire or other hazards may result.

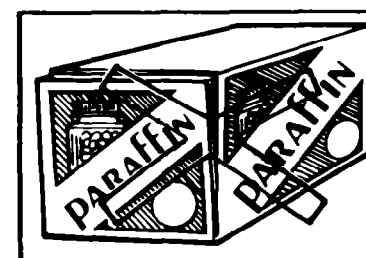

DO NOT try to melt paraffin wax in the oven. Fire or other hazards may result.

General Information

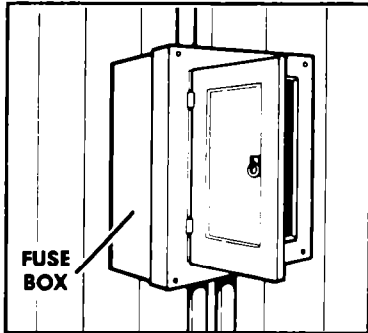

If your electric power line voltage is less than the normal 120 volts, cooking times may be longer.

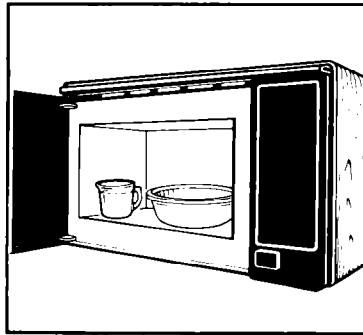

To test a dish for safe use, put it into the oven with a cup of water **beside it**. Cook on high Cook Power for one minute. **If the dish gets hot and water stays cool, do not use it.**

If you need service or assistance, we suggest you follow these five steps:

1. Before calling for assistance...

Performance problems often result from little things you can find and fix yourself without tools of any kind.

If nothing operates:

- Is the oven correctly plugged into a live circuit with the proper voltage? (See page 25.)
- Have you checked your home's main fuses or circuit breaker box?
- Have you checked the electric company for a power failure?

If the microwave oven will not run:

- Is the oven being used as a timer?
- If the Temperature Probe is being used, is it plugged tightly into its socket?
- Is the door firmly closed and latched?
- Did you touch START?
- Did you follow the directions exactly?

If microwave cooking times seem too long:

- Is the electric supply to your home low or lower than normal? Your electric company can tell you if the line voltage is low.
- Is the Cook Power at the recommended setting?
- Are you allowing more time when cooking more food at one time?

If the display shows a time counting down but the oven is not cooking:

- Is the oven door closed completely?
- Have you set the controls as a kitchen timer?
- Is the oven in standing time between QUICK DEFROST and COOK 1? (See page 12.)

If you do not hear the Programming Tone:

- Is the command correct?
- Has the tone been cancelled? (See page 6.)

If the fan seems to be running slower than usual:

- Has the oven been stored in a cold area? The fan will run slower until the oven warms up to normal room temperature.

If there has been a power interruption, the Display will show 88:88. Reset the clock, (page 6).

If the microwave oven turns off too soon or not soon enough when using the probe:

- Is at least $\frac{1}{3}$ of the probe in the food?
- Is the probe tip in the center of the food?
- Is the probe touching bone or fat?
- Have you allowed roasts to stand for a few minutes after cooking?
- Is the probe plugged tightly into its socket?
- Is Cook Power set correctly?
- Is the Probe Temperature set correctly?

2. If you need assistance*...

Call Whirlpool COOL-LINE® service assistance telephone number. Dial free from anywhere in the U.S.:

1-800-253-1301

and talk with one of our trained Consultants. The Consultants can instruct you in how to obtain satisfactory operation from your appliance or, if service is necessary, recommend a qualified service company in your area.

3. If you need service*...



Whirlpool has a nationwide network of franchised TECH-CARE® service Companies. TECH-CARE service technicians are trained to fulfill the product warranty and provide after-

warranty service, anywhere in the United States. To locate TECH-CARE service in your area, call our COOL-LINE service assistance telephone number (see Step 2) or look in your telephone directory Yellow Pages under:

APPLIANCES - HOUSEHOLD -
MAJOR - SERVICE & REPAIR

WHIRLPOOL APPLIANCES
FRANCHISED TECH-CARE SERVICE

SERVICE COMPANIES

XYZ SERVICE CO
123 MAPLE

999-9999

ELECTRICAL APPLIANCES -
MAJOR - REPAIRING & PARTS

WHIRLPOOL APPLIANCES
FRANCHISED TECH-CARE SERVICE

SERVICE COMPANIES

XYZ SERVICE CO
123 MAPLE

999-9999

OR

WASHING MACHINES, DRYERS
& IRONERS - SERVICING

WHIRLPOOL APPLIANCES
FRANCHISED TECH-CARE SERVICE

SERVICE COMPANIES

XYZ SERVICE CO
123 MAPLE

999-9999

4. If you have a problem*...

Call our COOL-LINE service assistance telephone number (see Step 2) and talk with one of our Consultants, or if you prefer, write to:

Mr. Robert Stanley
Division Vice President
Whirlpool Corporation
2000 US-33, North
Benton Harbor, MI 49022

5. If you need FSP® replacement parts*...

FSP is a registered trademark of Whirlpool Corporation for quality parts. Look for this symbol of quality whenever you need a replacement part for your Whirlpool appliance. FSP replacement parts will fit right and work right, because they are made to the same exacting specifications used to build every new Whirlpool appliance.

To locate FSP replacement parts in your area, refer to Step 2 above or call the Whirlpool COOL-LINE service assistance number in Step 3.

*If you must call or write, please provide: model number, serial number, date of purchase, and a complete description of the problem. This information is needed in order to better respond to your request for assistance.



Making your world a little easier.

Part No. 4B72006A/4158023
©1986 Whirlpool Corporation

Washers, Dishwashers, Built-In Ovens and Surface Units, Ranges, Microwave Ovens, Trash Compactors, Room Air Conditioners, Dehumidifiers, Automatic Washers, Clothes Dryers

