TAPPAN

**Gas Over/Under Range
with a Porcelain Enamel Upper Oven &
Self-Cleaning Lower Oven**

GAS RANGE



Product Registration

Register Your Product

The self-addressed **PRODUCT REGISTRATION CARD** should be filled in completely, signed and returned to Frigidaire Company.

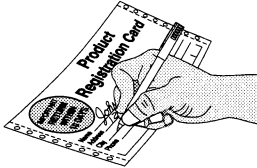

Thank you for choosing this appliance. The information contained within this **Owner's Guide** will instruct you on how to properly operate and care for your range. Please read through the information contained in your literature pack to learn more about your new appliance.

Record Your Model and Serial Numbers

Record in the space provided below the model and serial numbers found on the serial plate located under the lift-up cooktop.

Model Number: _____

Serial Number: _____

Date of Purchase: _____

Contents

This Owner's Guide contains general operating instructions for your range and feature information for several models. Your range **may not** have all the described features.

Versión en español

Si desea obtener una copia en español de este Manual del Usuario, sírvase escribir a la dirección que se incluye a continuación. Solicite la P/N316080254 (9706).

Spanish Owner's Guides (please specify)
Frigidaire Company
P. O. Box 9061
Dublin, Ohio 43017-0961

2	Product Registration
3-4	Important Safety Instructions
5-6	Range Features
7	Grounding Instructions (electric ignition models only)
7	Setting the Clock and Minute Timer (some models)
8	Flame Size
8	Proper Burner Adjustments
8	Setting Surface Controls
8	Before Setting Oven Controls
9	Setting Oven Controls
10-12	Oven Cleaning
13-15	General Cleaning
16	Changing Cooktop and/or Oven Lights (some models)
17	Adjusting Oven Temperature
18-19	Avoid Service Checklist
20	Warranty

Note: The instructions appearing in this Owner's Guide are not meant to cover every possible condition and situation that may occur. Common sense and caution must be practiced when installing, operating and maintaining any appliance.

⚠ WARNING If the information in this manual is not followed exactly, a fire or explosion may result causing property damage, personal injury or death.

FOR YOUR SAFETY:

- Do not store or use gasoline or other flammable vapors and liquids in the vicinity of this or any other appliance.
- **WHAT TO DO IF YOU SMELL GAS:**
 - Do not try to light any appliance.
 - Do not touch any electrical switch; do not use any phone in your building.
 - Immediately call your gas supplier from a neighbor's phone. Follow the gas supplier's instructions.
 - If you cannot reach your gas supplier, call the fire department.
- Installation and service must be performed by a qualified installer, servicer or the gas supplier.



IMPORTANT SAFETY INSTRUCTIONS

Read all instructions before using this appliance.
Save these instructions for future reference.

This guide contains important safety symbols and instructions. Please pay special attention to these symbols and follow all instructions given. Here is a brief explanation of the use of these symbols.

⚠ WARNING This symbol will help alert you to situations that may cause serious bodily harm, death or property damage.

⚠ CAUTION This symbol will help alert you to situations that may cause bodily injury or property damage.

- **Remove all tape and packaging wrap before using the range. Destroy the carton and plastic bags after unpacking the range.** Never allow children to play with packaging material.
- **Proper Installation—Be sure your appliance is properly installed and grounded by a qualified technician in accordance with the National Gas Code ANSI Z223.1—latest edition, the National Electrical Code ANSI/NFPA No. 70—latest edition, and local code requirements.** Install only per installation instructions provided in the literature package for this range.

Ask your dealer to recommend a qualified technician and an authorized repair service. Know how to disconnect the electrical power to the range at the circuit breaker or fuse box in case of an emergency.

- **User Servicing—Do not repair or replace any part of the appliance unless specifically recommended in the manuals.** All other servicing should be done only by a qualified technician to reduce the risk of personal injury and damage to the range.
- **Never modify or alter the construction of a range by removing leveling legs, panels, wire covers, anti-tip brackets/screws, or any other part of the product.**



⚠ WARNING

- ALL RANGES CAN TIP.
- INJURY TO PERSONS COULD RESULT.
- INSTALL ANTI-TIP DEVICE PACKED WITH RANGE.
- SEE INSTALLATION INSTRUCTIONS.

⚠ WARNING

TO REDUCE THE RISK OF TIPPING OF THE RANGE, THE RANGE MUST BE SECURED BY PROPERLY INSTALLED ANTI-TIP BRACKET(S) PROVIDED WITH THE RANGE. TO CHECK IF THE BRACKET(S) IS INSTALLED PROPERLY, REMOVE THE LOWER PANEL OR STORAGE DRAWER AND VERIFY THAT THE ANTI-TIP BRACKET(S) IS ENGAGED. REFER TO THE INSTALLATION INSTRUCTIONS FOR PROPER ANTI-TIP BRACKET(S) INSTALLATION.

⚠ WARNING Stepping, leaning or sitting on the doors or drawers of this range can result in serious injuries and may also cause damage to the range. Do not allow children to climb or play around the range. The weight of a child on an open door may cause the range to tip, resulting in serious burns or other injury.

⚠ WARNING Do not use the oven for storage.

- **Storage in or on Appliance—Flammable materials should not be stored in an oven, near surface burners or in the storage drawer (if equipped).** This includes paper, plastic and cloth items, such as cookbooks, plasticware and towels, as well as flammable liquids. Do not store explosives, such as aerosol cans on or near the range. Flammable materials may explode and result in fire or property damage.

⚠ CAUTION Do not store items of interest to children in the cabinets above a range or on the backguard of a range. Children climbing on the range to reach items could be seriously injured.

- **Do not leave children alone. Children should not be left alone or unattended in the area where an appliance is in use.** They should never be allowed to sit or stand on any part of the appliance.
- **DO NOT TOUCH SURFACE BURNERS, AREAS NEAR THESE BURNERS, OVEN BURNER OR INTERIOR SURFACES OF THE OVEN.** Areas near surface burners may become hot enough to cause burns. During and after use, do not touch, or let clothing or other flammable materials touch these areas until they have had sufficient time to cool. Among these areas are the cooktop, surfaces facing the cooktop, the oven vent openings and surfaces near these openings, oven door and window.
- **Wear Proper Apparel—Loose-fitting or hanging garments should never be worn while using the appliance.** Do not let clothing or other flammable materials contact hot surfaces.

⚠ WARNING Never use your appliance for warming or heating the room.

- **Do Not Use Water or Flour on Grease Fires—Smother the fire with a pan lid, or use baking soda, a dry chemical or foam-type extinguisher.**
- **When heating fat or grease, watch it closely.** Fat or grease may catch fire if allowed to become too hot.
- **Use Only Dry Potholders—Moist or damp potholders on hot surfaces may result in burns from steam.** Do not let the potholders touch the flame or burners. Do not use a towel or other bulky cloth instead of a potholder.
- **Do Not Heat Unopened Food Containers—Build-up of pressure may cause the container to burst and result in injury.**
- **Remove the oven door from any unused range if it is to be stored or discarded.**
- **IMPORTANT—Do not attempt to operate the oven during a power failure. If the power fails, always turn the oven off.** If the oven is not turned off and the power resumes, the oven will begin to operate again. Food left unattended could catch fire or spoil.

IMPORTANT SAFETY INSTRUCTIONS^(continued)

IMPORTANT INSTRUCTIONS FOR USING YOUR COOKTOP

- **Know which knob controls each surface heating unit.**

⚠ WARNING Use Proper Flame Size—Adjust flame size so it does not extend beyond the edge of the utensil. The use of undersized utensils will expose a portion of the burner flame to direct contact and may result in ignition of clothing. Proper relationship of utensil to flame will also improve efficiency.

- **Utensil Handles Should Be Turned Inward and Not Extend Over Adjacent Surface Burners**—To reduce the risk of burns, ignition of flammable materials, and spillage due to unintentional contact with the utensil, the handle of the utensil should be positioned so that it is turned inward, and does not extend over adjacent surface burners.
- **Never Leave Surface Burners Unattended at High Settings**—Boilovers cause smoking and greasy spillovers that may ignite, or a pan that has boiled dry may melt.
- **Protective Liners**—Do not use aluminum foil to line surface burner pans, the oven bottom or any other part of the range. Only use aluminum foil as recommended for baking if used as a cover placed on the food. Any other use of protective liners or aluminum foil may interfere with heat and air distribution, and combustion. Damage to the range or personal injury may result.
- **Glazed Cooking Utensils**—Only certain types of glass, glass/ceramic, ceramic, earthenware, or other glazed utensils are suitable for rangetop service without breaking due to the sudden change in temperature. Check the manufacturer's recommendations for rangetop use.
- **Do Not Use Decorative Surface Burner Covers.** If a burner is accidentally turned on, the decorative cover will become hot and possibly melt. You will not be able to see that the burner is on. Burns will occur if the hot covers are touched. Damage may also be done to the cooktop or burners because the covers may cause overheating. Air will be blocked from the burner and cause combustion problems.

IMPORTANT INSTRUCTIONS FOR USING YOUR OVEN

- **Use Care When Opening Door**—Stand to the side of the range when opening the door of a hot oven. Let hot air or steam escape before you remove or replace food in the oven.
- **Keep Oven Vent Ducts Unobstructed.** The upper oven vents through the top of the oven. The lower oven vents behind the cooktop. Touching the surfaces in this area when the oven is operating may cause severe burns. Also, do not place plastic or heat-sensitive items on or near the oven vent. These items could melt or ignite.

IMPORTANT INSTRUCTIONS FOR USING YOUR OVEN (continued)

- **Placement of Oven Racks.** Always place oven racks in desired location while oven is cool. If rack must be moved while oven is hot, use extreme caution. Use potholders and grasp the rack with both hands to reposition. Do not let potholders contact the oven burner flame or interior of the oven. Remove all utensils from the rack before removing rack.
- **Do not use the broiler pan without its insert.** The broiler pan and grid allow dripping fat to drain and be kept away from the high heat of the broiler.
- **Do not cover the broiler grid with aluminum foil. Exposed fat and grease could ignite.**
- **Do not touch a hot light bulb (some models) with a damp cloth.** Doing so could cause the bulb to break. Disconnect the range or turn off the power to the range before removing and replacing light bulb.

IMPORTANT INSTRUCTIONS FOR CLEANING YOUR RANGE

- **Clean the range regularly to keep all parts free of grease that could catch fire.** Pay particular attention to the area underneath each surface burner. Exhaust fan ventilation hoods and grease filters should be kept clean. Do not allow grease to accumulate. Greasy deposits in the fan could catch fire. Refer to the hood manufacturer's instructions for cleaning.
- **Kitchen cleaners/aerosols**—Always follow the manufacturer's recommended directions for use. Be aware that excess residue from cleaners and aerosols may ignite causing damage and/or injury.

SELF-CLEANING OVEN (Lower Oven):

- **Clean in the self-cleaning cycle only the parts of the oven listed in this owner's guide.** Before self-cleaning the oven, remove the broiler pan and any utensils stored in the oven.
- **Do not clean the oven door gasket.** The door gasket is essential for a good seal. Care should be taken not to rub, damage or move the gasket.
- **Do not use oven cleaners.** No oven cleaner or oven liner protective coating of any kind should be used in or around any part of the oven.

SAVE THESE INSTRUCTIONS

Range Features

Here is a quick guide to the features of your range and a handy index to the important information in the following pages.

Note: This guide is used for several models so the illustration may not be identical to your model. However, operating instructions for each of the features and functions of your range will be found in this guide.

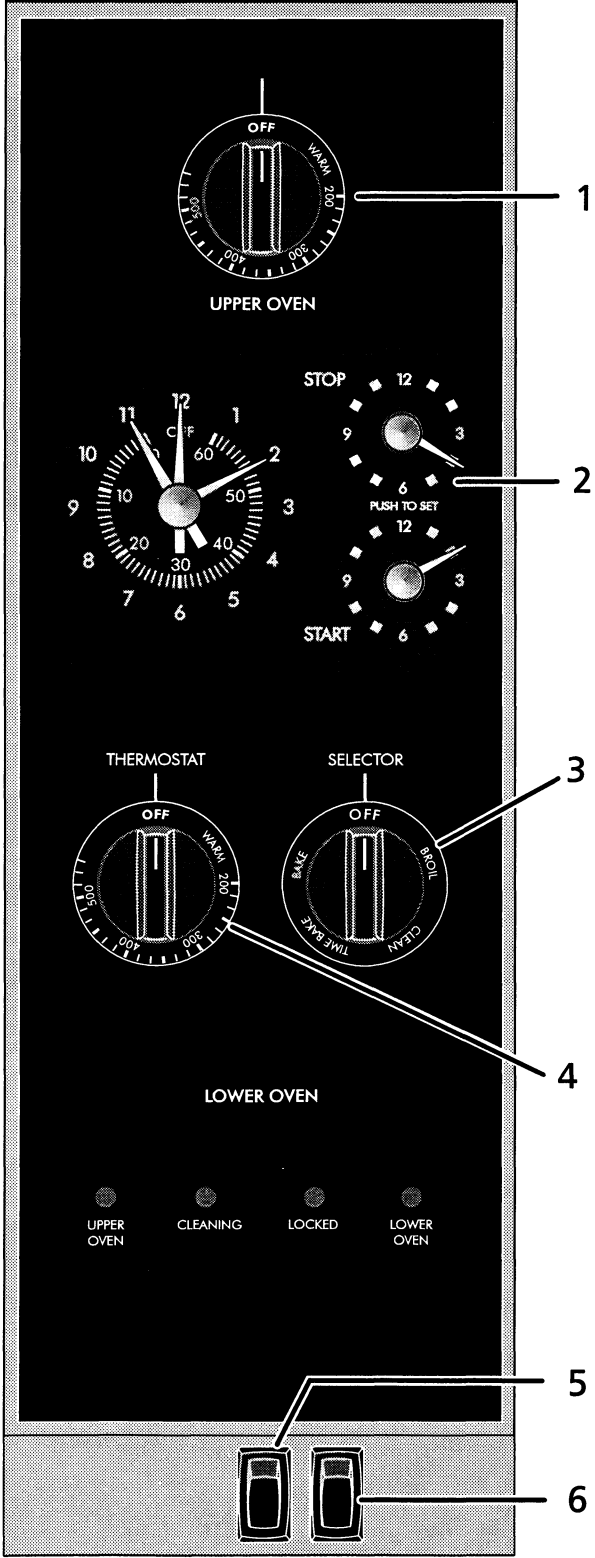
	Oven Controls
 <p>The diagram shows a control panel for an oven with the following features:</p> <ul style="list-style-type: none">1. Upper Oven Temperature Control: A large knob at the top with a temperature scale from 400 to 500 and positions for OFF and WARM.2. Clock and Minute Timer: Two smaller dials. The left one is a clock face with numbers 1-12 and 'C' for Celsius. The right one is a minute timer with numbers 3, 6, 9, 12 and 'PUSH TO SET' and 'START' labels.3. Lower Oven Selector Control: A knob with positions for OFF, BAKE, BROIL, and CLEAN.4. Lower Oven Temperature Control: A knob with a temperature scale from 300 to 500 and positions for OFF and WARM.5. Rocker Switch for the Fluorescent Cooktop Light: A switch at the bottom left.6. Oven Light Rocker Switch: A switch at the bottom right. <p>Other labels on the panel include 'UPPER OVEN', 'THERMOSTAT', 'SELECTOR', 'UPPER OVEN', 'CLEANING', 'LOCKED', and 'LOWER OVEN'.</p>	<p>Oven Controls</p> <ol style="list-style-type: none">1. Upper Oven Temperature Control—This is the on/off control for all upper oven cooking functions. Push in and turn knob to the temperature you want.2. Clock and Minute Timer—Serves as a time of day and minute timer. The minute timer does not start or stop cooking. It simply serves as a handy kitchen timer that buzzes when the set time has run out. The clock and minute timer are also used to program the timed bake and self-clean cycles in the lower oven.3. Lower Oven Selector Control—This is the on/off control for all lower oven cooking functions.4. Lower Oven Temperature Control—This control is used to select the desired cooking temperature.5. Rocker Switch for the Fluorescent Cooktop Light—Push to turn the fluorescent cooktop light on and off.6. Oven Light Rocker Switch—Push to turn oven lights on and off.

Range Features

Here is a quick guide to the features of your range and a handy index to the important information in the following pages.

Note: This guide is used for several models so the illustration may not be identical to your model. However, operating instructions for each of the features and functions of your range will be found in this guide.

Features

Upper Oven

The upper oven has a porcelain enamel oven interior.

1. **Eye-level Control Panel**
2. **Upper Oven Temperature Control**
3. **Clock and Minute Timer**—Serves as a time of day and minute timer. The minute timer does not start or stop cooking. It simply serves as a handy kitchen timer that buzzes when the set time has run out. The clock and minute timer are also used to program the timed bake and self-clean cycles in the lower oven.
4. **Oven Light Rocker Switch**—Push to turn the oven lights on and off.
5. **Rocker Switch for the Fluorescent Cooktop Light**—Push to turn the cooktop light on and off.

Lower Oven

The lower oven has a self-cleaning oven interior.

6. **Lower Oven Temperature & Selector Control knobs**
7. **Lift N'Lock Top**
8. **Serial Plate**—Located under the cooktop.
9. **Surface Control Knobs**—Operates the surface burners. To operate, push in and turn to LITE and then to the desired surface cooking setting (do not leave in the LITE position).
10. **Removable Oven Door**
11. **Storage Drawer**—Used to store pots and pans.
12. **Leveling Legs** (on all 4 corners of range bottom).
13. **Manual or Automatic (depending on your model) Door Latch**

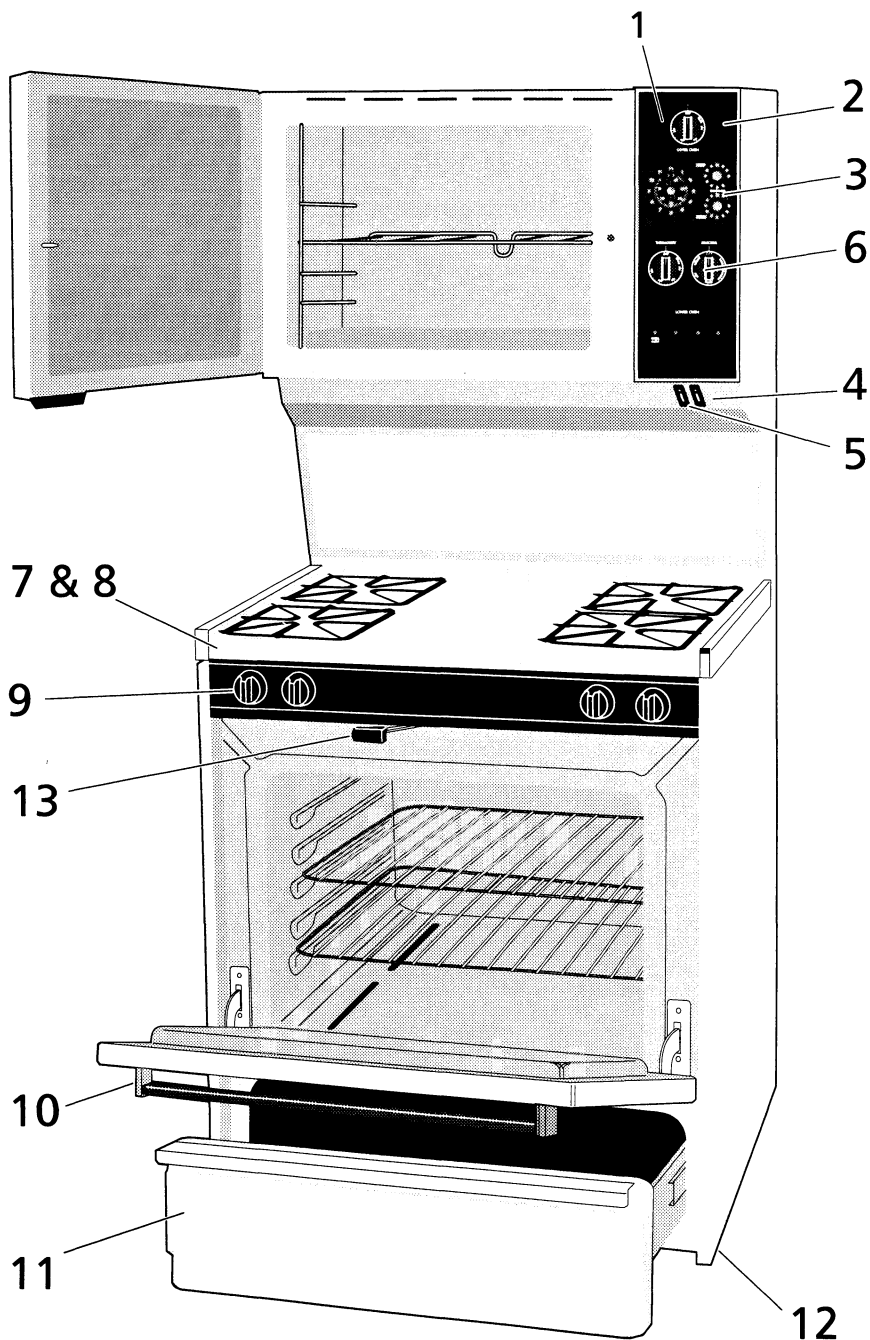

Grounding Instructions

(electric ignition models only)

⚠ WARNING Avoid fire hazard or electrical shock. Do not use an adaptor plug, an extension cord, or remove grounding prong from electrical power cord. Failure to follow this warning can cause serious injury, fire or death.

Grounding type
wall receptacle



Do not under any circumstances, cut, remove, or bypass the grounding prong from this plug.

Power supply
cord with 3-prong
grounding plug

IMPORTANT: READ AND SAVE THESE INSTRUCTIONS.

⚠ WARNING This appliance is equipped with a 3 prong grounding plug for your protection against shock hazard and should be plugged directly into a properly grounded receptacle. **DO NOT** cut or remove the grounding prong from this plug.

For personal safety, this oven must be properly grounded. For maximum safety, the power cord must be plugged into a 120V—60 Hz. outlet that is correctly polarized and properly grounded.

If a 2-prong wall receptacle is the only available outlet, it is the personal responsibility of the consumer to have it replaced with a properly grounded 3-prong wall receptacle installed by a qualified electrician.

DO NOT UNDER ANY CIRCUMSTANCES CUT OR REMOVE THE THIRD ROUND GROUNDING PRONG FROM THE POWER CORD PLUG. SEE THE INSTALLATION INSTRUCTIONS PACKAGED WITH THIS OVEN FOR COMPLETE INSTALLATION AND GROUNDING INSTRUCTIONS. DO NOT OPERATE THE OVEN USING A 2-PRONG ADAPTER OR AN EXTENSION CORD.

Setting the Clock and Minute Timer

(some models)

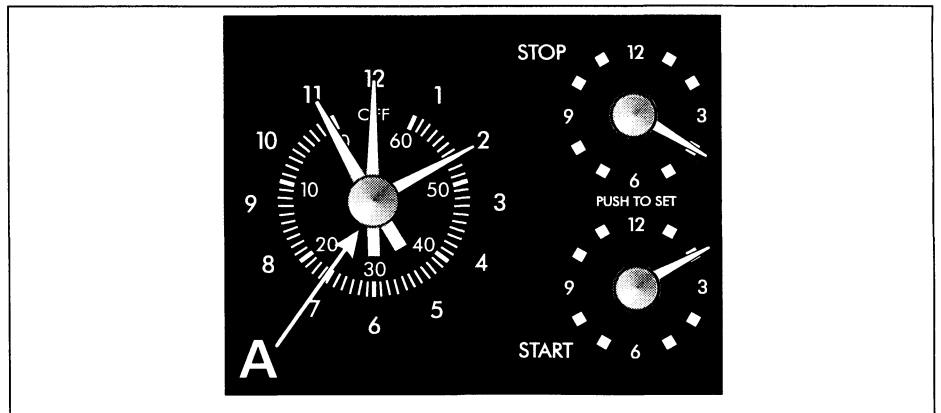

Your model may be equipped with the clock and minute timer shown above. Follow the instructions below to set the the clock and minute timer.

To Set the Clock

1. Push in and turn control knob **A** to set the time of day. The minute timer hand will turn as the clock is set.
2. After the clock is set, release the control knob and return the minute timer hand to 12 (OFF).

To Set the Minute Timer

The minute timer does not start or stop cooking. It simply serves as a handy kitchen timer that buzzes when the set time has run out.

1. Turn control knob **A** to set the desired number of minutes. For best accuracy, turn the minute timer hand *beyond the setting*, then back to it. **DO NOT** push in on the control when setting the minute timer. Doing so will change the clock.
2. When the set time has passed, the buzzer will sound. Turn the control to 12 (OFF).

Flame Size

Never extend the flame beyond the outer edge of the utensil. A higher flame simply wastes heat and energy, and increases your risk of being burned by the flame.

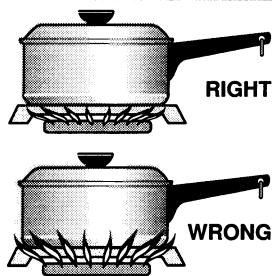

For most cooking, start on the highest control setting and then turn to a lower one to complete the process. Use the chart below as a guide for determining proper flame size for various types of cooking. The size and type of utensil used and the amount of food being cooked will influence the setting needed for cooking.

For deep fat frying, use a thermometer and adjust the surface control knob accordingly. If the fat is too cool, the food will absorb the fat and be greasy. If the fat is too hot, the food will brown so quickly that the center will be undercooked. Do not attempt to deep fat fry too much food at once as the food will neither brown nor cook properly.

*Flame Size	Type of Cooking
High Flame	Start most foods; bring water to a boil; pan broiling
Medium Flame	Maintain a slow boil; thicken sauces, gravies; steam
Low Flame	Keep foods cooking; poach; stew

*These settings are based on using medium-weight aluminum pans with lids. Settings may vary when using other types of pans.

Proper Burner Adjustments

The color of the flame is the key to proper burner adjustment. A good flame is clear, blue and hardly visible in a well-lighted room. Each cone of flame should be steady and sharply defined. Adjust or clean burner if flame is yellow-orange. To clean burner, see instructions under **General Cleaning**.

Setting Surface Controls

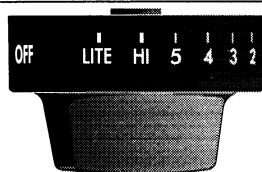

CAUTION Do not place plastic items such as salt and pepper shakers, spoon holders or plastic wrappings on top of the range when it is in use. These items could melt or ignite. Potholders, towels or wood spoons could catch fire if placed too close to a flame.

Each burner lights automatically from an electric ignitor each time a control knob is turned to the LITE position.

To operate the surface burner:

1. Place cooking utensil on burner.
2. Push in and turn the Surface Control knob to LITE. **Note:** All electronic ignitors will click at the same time. However, only the burner you are turning on will ignite.
3. Visually check that the burner has lit.
4. After the burner lights, turn the control knob to the desired flame size. The control knobs do not have to be set at a particular mark. Use the guides and adjust the flame as needed. **DO NOT** cook with the control knob in the LITE position. (The electronic ignitor will continue to click if left in the LITE position.)

In the event of an electrical power outage, the surface burners can be lit manually. To light a surface burner, hold a lit match to the burner head, then slowly turn the surface control knob to LITE. Use caution when lighting surface burners manually.

Before Setting Oven Controls

Oven Vent Locations (shown)

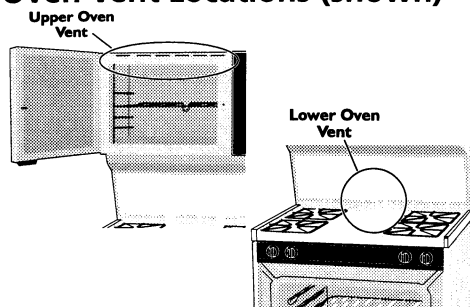

When appliance is on, warm air is released through the vents. This venting is necessary for proper burner operation and good baking results.

Arranging Oven Racks

(Some models may have one rack.) **ALWAYS ARRANGE OVEN RACKS WHEN THE OVEN IS COOL** (Prior to operating the oven). Always use oven mitts when using the oven and broiling compartments.

To remove an oven rack, pull the rack forward until it stops. Lift up front of rack and slide out. **To replace an oven rack**, fit the rack onto the guides on the oven walls. Tilt the front of the rack upward and slide the rack back into place.

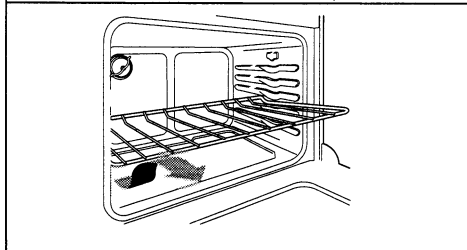

To bake on one rack, place the rack on position 3 or 4. **To bake on two racks (some models)**, place the racks on positions 2 and 4.

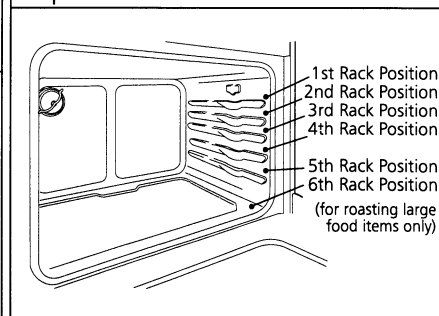

Setting Oven Controls

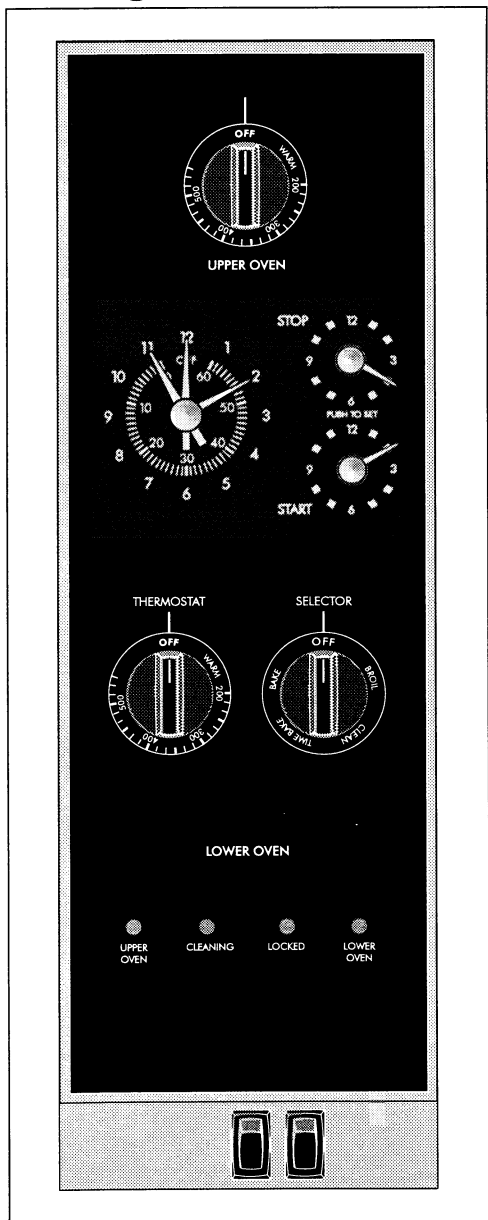

To Bake

1. Arrange oven racks while the oven is still cool. See "Arranging Oven Racks" under **Before Setting Oven Controls**.
2. Push in and turn the Temperature Control knob to the desired temperature.
3. Turn the Selector Control knob to BAKE. (Applies to the lower oven only; skip step if you are setting the controls for the upper oven.)
4. Preheat the oven for 10 to 12 minutes before baking. Preheating is not necessary when roasting, cooking casseroles or broiling most foods.
5. When cooking is finished, turn the Temperature Control knob (and Selector Control knob; lower oven only) to OFF.

To Set the Automatic Timer or Time Bake Feature (Lower Oven)

The lower oven has an automatic timer function. This function allows you to turn the oven on and off automatically at the times you select in advance.

To operate:

1. Make sure the clock is set to the correct time of day and the Start and Stop knobs are popped out.
2. Turn the Selector Control knob to TIME BAKE.
3. Push in and turn the Temperature Control knob to the desired cooking temperature.
4. If you want the timed bake cycle to begin immediately, make sure the Start Time is set the same as the current time on the clock. If a delayed start cycle is desired, push in and turn the set the Start knob to the time you want the timed bake cycle to begin.
5. Push in and turn the Stop knob to the time you want cooking to stop.
6. The oven will begin to operate when the start time has been reached.
7. After you take the food out of the oven, be sure to turn the Temperature and Selector Control knobs to OFF.

CAUTION Use caution when using the automatic timer. Use the automatic timer when cooking cured or frozen meats and most fruits and vegetables. Foods that can easily spoil such as milk, eggs, fish, meat or poultry, should be chilled in the refrigerator first. Even when chilled, they should not stand in the oven for more than one hour before cooking begins, and should be removed promptly when cooking is completed.

To Broil (Lower Oven)

1. Arrange oven rack(s) while the oven is still cool. For rare meats, position the broiler pan closer to the burner (upper position). For well-done foods such as chicken, lobster tails or thick cuts of meat, position the pan further from the burner (lower position).
2. Turn the Selector Control knob to BROIL. (Applies to the operation of the lower oven only; skip step if operating the upper oven.)
3. For both ovens, push in and turn the Temperature Control knob to BROIL. In the lower oven, you may adjust the Temperature Control knob down to avoid excess browning or drying of foods that should be cooked to the well-done stage.
4. Place the grid on the broiler pan, then place the meat on the grid. **DO NOT** use the broiler pan without the grid or cover the grid with aluminum foil. The exposed fat could ignite.
5. Place the pan on the oven rack. Close the oven door.
6. Broil on one side until food is browned; turn and cook on the second side. Season and serve. **Note:** Always pull the rack out to the stop position before turning or removing food.
7. When broiling is finished, turn the Temperature (and Selector Control knob, lower oven only) Control knob to OFF.

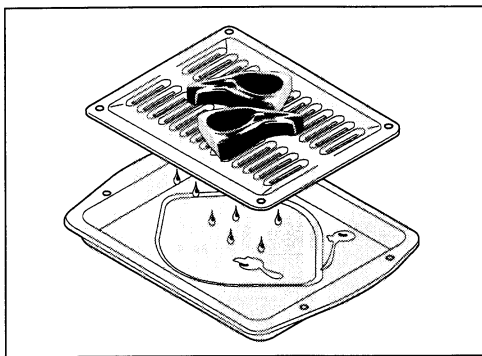

CAUTION Should an oven fire occur, leave the oven door closed and turn the oven off. If the fire continues, throw baking soda on the fire or use a fire extinguisher. **DO NOT** put water or flour on the fire. Flour may be explosive.

Oven Cleaning

Porcelain Enamel Oven (Upper Oven)

Porcelain has a smooth finish and is a type of glass fused to metal. Oven cleaners can be used on all interior oven surfaces.

Adhere to the following cleaning precautions:

- Allow the oven to cool before cleaning.
- Wear rubber gloves when cleaning the appliance manually.

REMOVE SPILLOVERS AND HEAVY SOILING AS SOON AS POSSIBLE. **REGULAR CLEANINGS WILL REDUCE THE NUMBER OF MAJOR CLEANINGS LATER.**

CAUTION Ammonia must be rinsed before operating the oven. Provide adequate ventilation.

CAUTION DO NOT line the oven walls, bottom, racks or any other part of the appliance with aluminum foil. Doing so will destroy heat distribution, produce poor baking results and cause permanent damage to the oven interior (aluminum foil will melt to the interior surface of the oven).

General Cleaning

Remove soils using hot, soapy water. Do not allow food spills with a high sugar or acid content (such as milk, tomatoes, sauerkraut, fruit juices or pie filling) to remain on the surface as they may cause a dull spot even after cleaning.

To Remove Heavy Soil

1. Allow a dish of ammonia to sit in the oven overnight or for several hours with the oven door closed. Clean softened spots using hot, soapy water. Rinse well with water and a clean cloth.
2. If soil remains, use a soap-filled scouring pad or a nonabrasive cleaner. If necessary, use an oven cleaner following manufacturer's instructions. **DO NOT** mix ammonia with other cleaners.

Adhere to the following precautions when using oven cleaners:

1. **DO NOT** spray on the electrical controls or switches because it could cause a short circuit and result in sparking or fire.
2. **DO NOT** allow a film from the cleaner to build up on the temperature sensing bulb; it could cause the oven to heat improperly. (The bulb is located at the right side of the upper oven.) Carefully wipe the bulb clean after each oven cleaning, being careful not to move the bulb. A change in its position could affect how the oven bakes. Avoid bending the bulb and capillary tube.
3. **DO NOT** spray any cleaner on the oven door trim or gasket, handles or any exterior surfaces of the range, wood or painted surfaces. The cleaner can damage these surfaces.

To Clean the Oven Bottom

Clean using hot, soapy water, a mild abrasive cleanser, a soap-filled abrasive pad or oven cleaner following manufacturer's instructions.

Oven Cleaning (continued)

CAUTION During the self-cleaning cycle, the outside of the appliance can become very hot to the touch. Do not leave small children unattended near the appliance.

CAUTION DO NOT line the oven walls, racks, bottom or any other part of the appliance with aluminum foil. Doing so will destroy heat distribution, produce poor baking results and cause permanent damage to the oven interior (aluminum foil will melt to the interior surface of the oven).

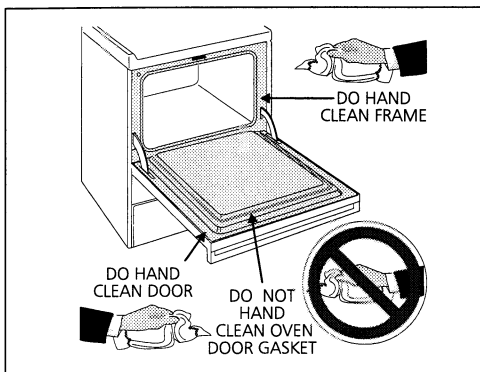

Self-Cleaning Oven (Lower Oven)

The lower oven has a self-cleaning oven interior.

A self-cleaning oven cleans itself with high temperatures (well above cooking temperatures) which eliminate soil completely or reduce it to a fine powdered ash you can whisk away with a damp cloth.

1. Adhere to the following cleaning precautions:

- Allow the oven to cool before precleaning.
 - Wear rubber gloves when precleaning and while wiping up the residue after the self-clean cycle.
 - **DO NOT** use oven cleaners or oven protective coatings in or around any part of the self-cleaning oven.
 - **DO NOT** clean the oven door gasket. The woven material of the oven door gasket is essential for a good seal. Care should be taken not to rub, damage or remove the gasket.
 - **DO NOT** use any cleaning materials on the oven door gasket. Doing so could cause damage.
2. Remove the broiler pan and insert, all utensils and any aluminum foil. These items cannot withstand high cleaning temperatures.
 3. Oven racks may be left in the oven or may be removed. If they go through the clean cycle their color will turn slightly blue and the finish will be dull. After the cycle is complete and the oven has cooled, rub the sides of the racks with wax paper or a cloth containing a small amount of baby oil or salad oil (this will make the racks glide easier into the rack positions).
 4. Remove any excess spillovers in the oven cavity before starting the self-cleaning cycle. To clean, use hot, soapy water and a cloth. Large spillovers can cause heavy smoke or fire when subjected to high temperatures. **DO NOT** allow food spills with a high sugar or acid content (such as milk, tomatoes, sauerkraut, fruit juices or pie filling) to remain on the surface as they may cause a dull spot even after cleaning.
 5. Clean any soil from the oven frame, the door liner outside the oven door gasket and the small area at the front center of the oven bottom. These areas heat sufficiently to burn soil on. Clean with soap and water.

Stopping or Interrupting the Self-Cleaning Cycle

If it becomes necessary to stop or interrupt a self-cleaning cycle due to excessive smoke or fire:

1. Turn the Selector and Temperature Control knobs to OFF.
2. Turn the Stop Time knob to the time of day set on the clock. The knob will then pop out.
3. Once the oven has cooled below 550°F and the "Lock" light has gone out, the door can now be opened.

CAUTION DO NOT force the oven door or the manual door locking lever open. Forcing the door open can damage the door lock. The oven must cool for approximately 1 hour (or below 550°F) before the door lock can be opened. Use caution when opening the door after the self-cleaning cycle is completed. The oven may still be VERY HOT.

4. Correct the condition which caused the smoking.
5. Restart the self-clean cycle once all conditions have been corrected.

Oven Cleaning (continued)

To Start the Self-Clean Cycle (Lower Oven)

*We recommend a 2 hour self-clean cycle for **light soils**, a 3 hour cycle for **average soils**, and a 4 hour cycle for **heavy soils** (to assure satisfactory results).

To Set the Controls:

1. Make sure the clock is set to the correct time of day and the Start and Stop knobs are popped out.
2. Turn the Selector Control knob to CLEAN.
3. If you want the clean cycle to begin immediately, make sure the Start Time is set the same as the current time on the clock. If a delayed start cycle is desired, push in and turn the Start Time knob to the time you want the clean cycle to begin.
4. Push in and turn the Stop Time knob at least 2 hours beyond the time shown on the Start Time knob. Set the cleaning time based on the amount of soil you have—light, medium or heavy. *See above.
5. Move the oven door locking lever to the right. When the oven reaches high cleaning temperatures, the "Lock" light will come on and you will *not* be able to unlock the door until the oven has cooled below 550°F.
6. After the desired cleaning time has elapsed, the Stop Time knob will pop out.
7. Be sure to turn the Temperature and Selector Control knobs to OFF when the self-cleaning cycle is completed.
8. Once the oven has cooled below 550°F and the "Cleaning" light has gone out, the oven door can now be opened. To open the door, move the locking lever back to the left.

CAUTION Use care when opening the oven door. Stand to the side of the oven when opening the door to allow hot air or steam to escape.

CAUTION DO NOT force the oven door or the manual door locking lever open. Forcing the door open can damage the door lock. The oven must cool for approximately 1 hour (or below 550°F) before the door lock can be opened. Use caution when opening the door after the self-cleaning cycle is completed. The oven may still be VERY HOT.

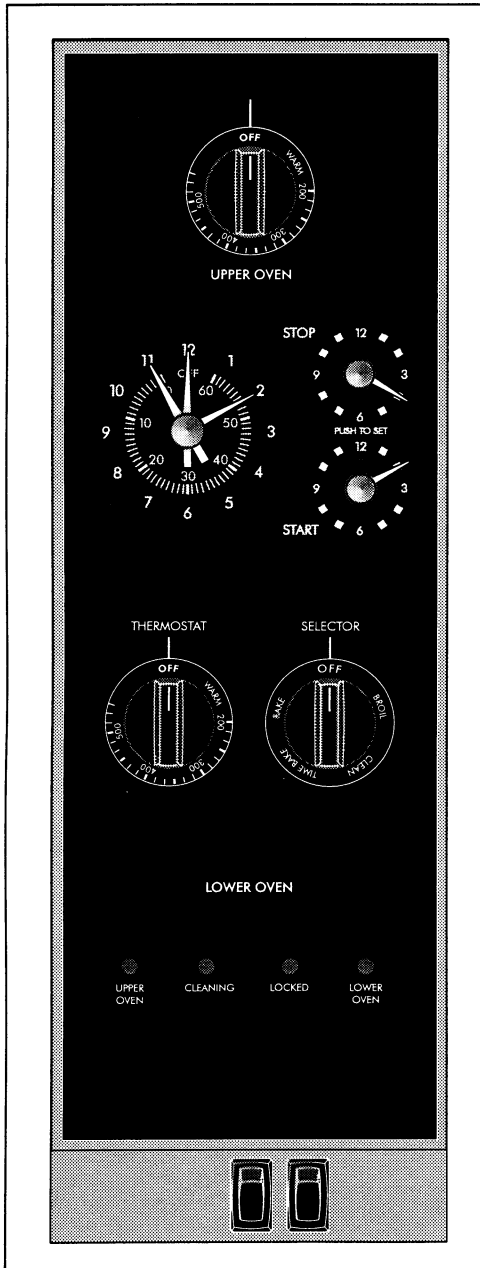

General Cleaning

Cleaning Various Parts of Your Range

Before cleaning any part of the range, be sure all controls are turned OFF and the range is COOL. REMOVE SPILLOVERS AND HEAVY SOILING AS SOON AS POSSIBLE. REGULAR CLEANINGS WILL REDUCE THE NUMBER OF MAJOR CLEANINGS LATER.

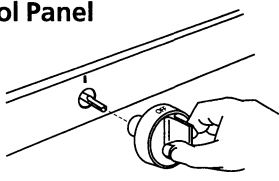
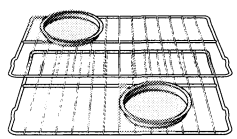
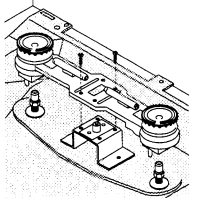
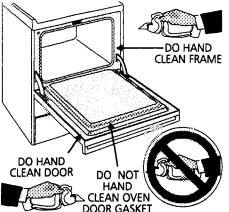
Surfaces	How to Clean
Aluminum (Trim Pieces) & Vinyl	Use hot, soapy water and a cloth. Dry with a clean cloth.
Glass, Painted and Plastic Body Parts, Control Knobs and Decorative Trim Pieces	<i>For general cleaning</i> , use hot, soapy water and a cloth. <i>For more difficult soils and built-up grease</i> , apply a liquid detergent directly onto the soil. Leave on soil for 30 to 60 minutes. Rinse with a damp cloth and dry. DO NOT use abrasive cleaners on any of these materials; they can scratch.
Control Panel 	<i>Before cleaning the control panel</i> , turn all controls to OFF and remove the control knobs. To remove, pull each knob straight off the shaft. Clean as instructed above. Squeeze excess water from the cloth before wiping the panel; especially when wiping around the controls. Excess water in or around the controls may cause damage to the appliance. To replace knobs after cleaning, line up the flat sides of both the knob and the shaft, then push the knob(s) into place.
Porcelain Enamel Burner Grates, Cooktop Surface, Below Cooktop, Broiler Pan, Insert within Broiler Compartment, Roll-out Broiler, Door Liner and Oven Bottom	Clean burner grates, broiler pan and insert in the dishwasher and dry upon removal. If soils are not removed, follow the cooktop cleaning instructions below. Gentle scouring with a soapy scouring pad will remove most spots. Rinse with a 1:1 solution of clean water and ammonia. <i>If necessary</i> , cover difficult spots with an ammonia-soaked paper towel for 30 to 40 minutes. Rinse with clean water and a damp cloth, then scrub with a soap-filled scouring pad. Rinse and wipe dry with a clean cloth. Remove all cleaners or the porcelain may become damaged during future heating. DO NOT use spray oven cleaners on the range top.
Stainless Steel, Chrome Parts, Drip Pans	Clean with hot, soapy water and a dishcloth. Rinse with clean water and a cloth. Cover stubborn spots with an ammonia-soaked paper towel for 30-40 minutes. Rinse. Cleaners made especially for stainless steel are recommended. Be sure to rinse the cleaners as bluish stains may occur during heating and cannot be removed.
Oven Racks 	Remove racks. See "Removing and Replacing Oven Racks" under Before Setting Oven Controls . Use a mild, abrasive cleaner, following manufacturer's instructions. Rinse with clean water and dry. After cleaning the racks, rub the sides of the racks with wax paper or a cloth containing a small amount of baby oil or salad oil (this will make the racks glide easier into the rack positions).
Surface Burners 	The holes in the burners of your range must be kept clean at all times for proper ignition and a complete, even flame. Clean the burner holes routinely with a small gauge wire or needle and especially after bad spillovers which could clog these holes. <i>To remove and replace burner units</i> per your model, see "To Remove and Replace Burners" under General Cleaning . <i>To clean</i> , soak the burners in a 1:1 solution of ammonia and water for 30 to 40 minutes. For stubborn stains, scrub with soap and water or a mild abrasive cleanser and a damp cloth. Dry the burners thoroughly in a warm oven for 30 minutes. Then replace them, making sure they are properly seated and level. DO NOT wash burner units in the dishwasher.
Oven Door 	To clean the oven door and exterior door frame, wash with hot, soapy water and a clean cloth. DO NOT immerse the door in water. DO NOT clean the oven door seal. The woven material of the oven door seal is essential for a good seal. Care should be taken not to rub, damage or remove the oven door seal.

General Cleaning

(continued)

⚠ WARNING When lowering the top, grasp the sides with fingertips only. Be careful not to pinch fingers. Also, **DO NOT** drop or bend the rangetop when raising or lowering. This could damage the surface.

⚠ WARNING DO NOT turn the burners on when the cooktop is raised for cleaning. Be sure that the top is completely lowered and securely in place before turning on the burners.

Figure 1

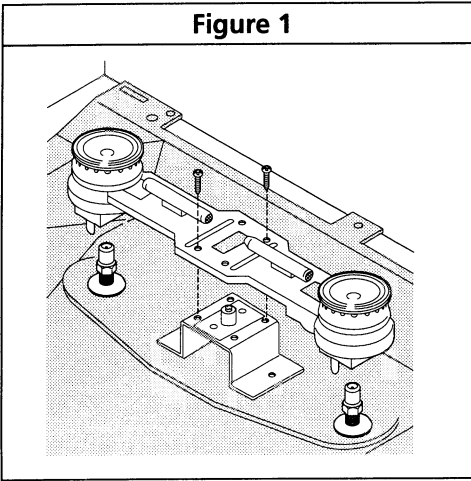

To Raise and Lower the Top for Cleaning

1. Remove burner grates and spillover bowls. Set aside.
2. Grasp the sides of the cooktop and then lift from the front.
3. Lift the top high enough to allow the support rods to snap into place. The **Lift-up rods** will support the top in its raised position.
4. Clean underneath using hot, soapy water and a clean cloth; then, dry.
5. Lower the top gently by pushing back on each rod. This will release the notched support. Hold the range top and slide the range top down into the range frame.

To Remove and Replace Burners for Cleaning

To Remove Burners (see Figure 1)

1. Remove shipping screws with a Phillips® Head screwdriver. See illustration for screw locations.
2. Lift burner up and out of range.

To Replace Burners

1. Place burner pair over mounting bracket. Make sure burners are positioned over gas valves and are properly positioned and level.
2. Replace shipping screws if desired.

General Cleaning

(Continued)

CAUTION The door is heavy. For safe, temporary storage, lay the door flat with the inside of the door facing down.

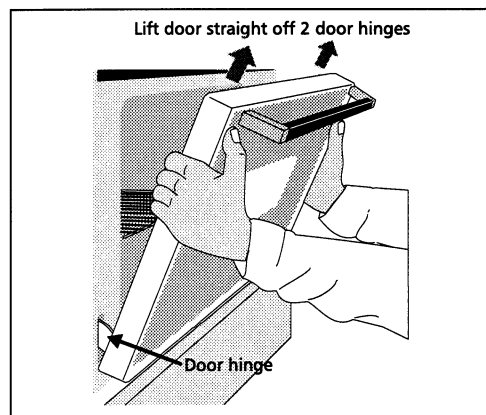

The upper oven door is not removable by the consumer. The lower oven door however can be removed.

To Remove and Replace the Lower Oven Door

To Remove Oven Door:

1. Open the door to the quarter-open position. Grasp the door firmly on both sides and lift up and off the hinges. To clean oven door, see the cleaning chart on page 13.

To Replace Oven Door:

1. Be sure the hinge arms are in the quarter-open position. Be careful if pulling the hinges open by hand. The hinges may snap back against the oven frame and could pinch fingers.
2. Hold the door at the sides near the top. Insert the hinge arms into slots at the bottom of the door.
3. Hinge arms must go into the range slots evenly. The hinge arms should be inserted into the bottom corners of the door as far as they can go.
4. If the door is not in line with the oven frame, remove it and repeat the above steps.

To Remove and Replace the Oven Bottom in the Upper Oven
The oven bottom in the lower oven is not removable. The upper oven bottom however can be removed.

To Remove the Oven Bottom:

1. Slide the oven bottom out from the back of the oven away from the slots.

To Replace the Oven Bottom:

1. Slide the oven bottom in making sure the tabs insert into the slots in the back of the oven.

Changing Cooktop and/or Oven Lights

(some models)

CAUTION Be sure the range is unplugged and all parts are COOL before replacing the oven lights. Wear a leather-faced glove for protection against possible broken glass.

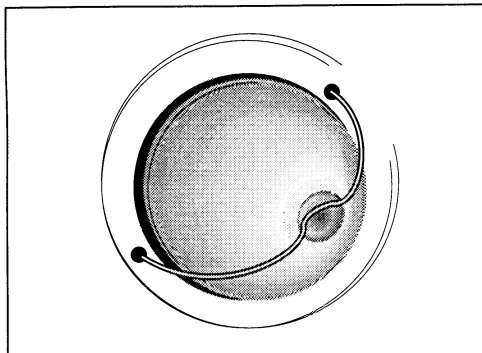
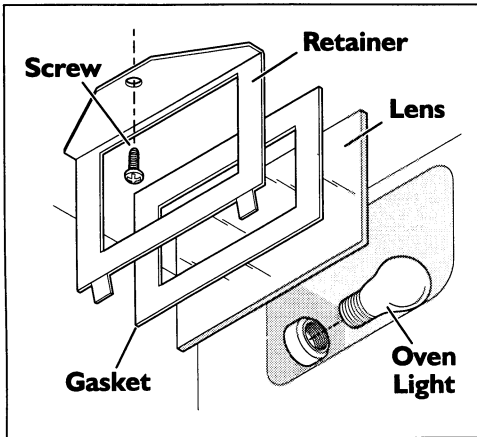

The upper and lower oven lights work together. When the oven light switch, located below the control panel, is turned on, both oven lights will come on. Both lights will come on if the lower oven door is opened.

To Change the Upper Oven Light

The oven light is located at the right side of the upper oven.

To Replace the Upper Oven Light:

1. Turn electrical power off at the main source or unplug the range.
2. Remove the screw holding the oven light lens retainer in place.
3. Tilt the oven light lens retainer away from oven side wall and lift up to release the bottom flanges. Be careful not to allow the glass lens to fall and break.
4. Remove retainer, gasket and lens.
5. Replace bulb with a new 40 watt appliance bulb.
6. Replace lens, gasket, retainer and screw.
7. Turn power back on again at the main source (or plug the range back in).
8. The clock (if equipped) will then need to be reset. To reset, see **Setting the Clock and Minute Timer** in this Owner's Guide.

To Change the Lower Oven Light

The oven light is located at the rear of the oven.

To Replace the Lower Oven Light:

1. Turn electrical power off at the main source or unplug the range.
2. Press wire holder to one side to release the glass shield.
3. Replace bulb with a new 40 watt appliance bulb.
4. Replace glass shield over bulb and snap wire holder into place.
5. Turn power back on again at the main source (or plug the range back in).
6. The clock (if equipped) will then need to be reset. To reset, see **Setting the Clock and Minute Timer** in this Owner's Guide.

Cooktop Light

A switch, located on the upper control panel, turns the cooktop light on and off.

The cooktop light is located behind the rear backsplash glass and must be replaced by a service technician.

Adjusting Oven Temperature (some models)

The temperature in the oven has been set at the factory. When first using the oven, be sure to follow recipe times and temperatures. If you think the oven is too hot or too cool, the temperature in the oven can be adjusted. Before adjusting, test a recipe by using a temperature setting that is higher or lower than the recommended temperature. The baking results should help you to decide how much of an adjustment is needed.

Figure 1: Back of Control Knob

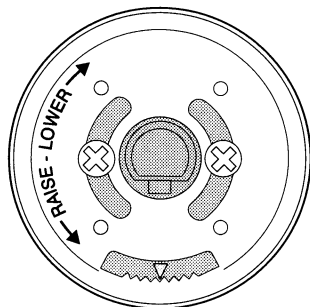

Note position of pointer prior to adjustment

To Adjust Oven Temperature:

1. Check to be sure the Temperature Control knob is in the OFF position.
2. Pull Temperature Control knob straight off the shaft.
3. On the back of the knob, there is a series of 5 to 7 small grooves. Note the position of the pointer (located in the middle groove). Loosen the two screws on the back of the knob (Figure 1). Note: If the knob does not have 2 screws, it is not adjustable.
4. To increase or decrease the temperature, move the pointer in the desired direction according to the "raise - lower" (some models) arrow, or "hotter - cooler" (some models) arrow. The temperature can be adjusted in increments as indicated on the back of the knob.
5. When the desired adjustment is reached, tighten both screws.
6. To replace the knob, line up the flat sides of both the knob and the shaft. Push the knob into place. **DO NOT** force the Temperature Control knob onto the shaft or you may damage the back of the knob.

Note: Once an adjustment is made, the OFF position will vary from the reference mark on the backguard depending on the amount of adjustment.

Avoid Service Checklist

Before you call for service, review this list. It may save you time and expense. The list includes common occurrences that are not the result of defective workmanship or materials in this appliance.

OCCURRENCE

POSSIBLE CAUSE/SOLUTION

Range is not level.

Poor installation. Place oven rack in center of oven. Place a level on the oven rack. Adjust leveling legs at base of range until the rack is level.

Weak, unstable floor. When oven is level, cooktop may not appear to be level with countertop. Be sure floor is level and can adequately support range. Contact a carpenter to correct sagging or sloping floor.

Kitchen cabinet misalignment may make range appear to be unlevel. Be sure cabinets are square and have sufficient room for range clearance.

**Cannot move appliance easily.
Appliance must be accessible for service.**

Cabinets not square or are built in too tight. Contact a cabinet maker to correct the problem.

Contact builder or installer to make appliance accessible.

Carpeting interferes with range. Provide sufficient space so range can be lifted over carpet.

Gas line is hard-plumbed. Have a flexible A.G.A. approved metal appliance connector installed.

Surface burners do not light.

Surface Control knob has not been completely turned to LITE. Push in and turn the Surface Control knob to LITE until burner ignites and then turn control to desired flame size.

Burner ports are clogged. See "To Remove and Replace Burners" under **General Cleaning** within the chart titled "Cleaning Various Parts of Your Range." With the burner off, use a small-gauge wire or needle to clean ports.

Range power cord is disconnected from outlet. Be sure cord is securely plugged into the outlet.

Electrical power outage. Burners can be lit manually. See **Setting Surface Controls** in this Owner's Guide.

Surface burner flame burns half way around.

Burner ports are clogged. With the burner off, clean ports with a small-gauge wire or needle.

Moisture is present after cleaning. Lightly fan the flame and allow burner to operate until flame is full. Dry the burners thoroughly following instructions under **General Cleaning**.

Surface burner flame is orange.

Dust particles in main line. Allow the burner to operate a few minutes until flame turns blue.

In coastal areas, a slightly orange flame is unavoidable due to salt air.

Oven does not operate.

Temperature and/or Selector Control knobs are not set properly. Make sure the Temperature and/or Selector Control knobs are set to the desired function. See **Setting Oven Controls**. Make sure the automatic timer is set to the current time of day and the control knobs are popped out (if not using the timed bake or automatic timer feature).

Be sure regulator gas valve is "ON". See installation instructions.

Entire appliance does not operate.	Make sure cord/plug is plugged tightly into outlet.
	Service wiring not complete. Contact servicer or dealer.
	Electrical power outage (electric ignition models only). Check house lights to be sure. Call your local electric company for service. Surface burners can be lit manually. See Setting Surface Controls in this Owner's Guide.
	Be sure gas supply is turned on.
Oven and/or cooktop light (some models) does not work.	Burned-out or loose bulb. See Changing Cooktop and/or Oven Lights (some models) in this Owner's Guide to replace or tighten the bulb.
Oven smokes excessively during broiling.	Meat too close to broil burner. Reposition the rack to provide more clearance between the meat and the broiler.
	Meat not properly prepared. Remove excess fat from meat. Slash remaining fatty edges to prevent curling, but do not cut into the lean.
	Broiler pan used without grid or grid covered with foil. DO NOT use the broiler pan without grid or cover grid with foil.
	Broiler drawer/door open. Make sure drawer/door is closed when broiling.
	Broiler drawer/door needs cleaning. Excessive smoke is caused by old grease or food spatters. If the broiler is used often, clean on a regular basis.
Poor baking results.	Many factors affect baking results. Make sure the proper rack position is used. Center food in the oven and space pans to allow air to circulate. Allow the oven to preheat to the set temperature before placing food in the oven. Try adjusting the recipe's recommended temperature or baking time. If you feel the oven is too hot or cool, see Adjusting Oven Temperature in this Owner's Guide.
Self-Cleaning Cycle does not work.	Controls are not set properly. Follow instructions under Oven Cleaning .
	Self-cleaning cycle was interrupted. Stop time must be set 2 to 4 hours past the start time. Follow steps under "Stopping or Interrupting a Self-Clean Cycle" under Oven Cleaning .
Soil is not completely removed after self-cleaning cycle.	Failure to clean bottom front, top of oven or door area outside the oven seal. These areas are not in the self-cleaning area, but get hot enough to burn on residue. Clean these areas before starting the self-clean cycle. Burned-on residue may be cleaned with a stiff nylon brush and water or a nylon scrubber. Be careful not to damage the oven seal.
	Excessive spillovers in oven. Set self-clean cycle for a longer cleaning time.
Flames inside oven or smoke from vent.	Excessive spillovers in oven. This is normal, especially for pie spillovers or large amounts of grease on the oven bottom. Wipe up excessive spillovers before starting the self-clean cycle. If flames or excessive smoke are present, stop the self-clean cycle and follow the steps under "Stopping or Interrupting the Self-Clean Cycle" in the Oven Cleaning section.

TAPPAN RANGE WARRANTY

Your Tappan product is protected by this warranty

	WARRANTY PERIOD	TAPPAN, THROUGH ITS AUTHORIZED SERVICERS, WILL:	THE CONSUMER WILL BE RESPONSIBLE FOR:
FULL ONE-YEAR WARRANTY	One year from original purchase date.	Pay all costs for repairing or replacing any parts of this appliance which prove to be defective in materials or workmanship.	Costs of service calls that are listed under NORMAL RESPONSIBILITIES OF THE CONSUMER.*
LIMITED WARRANTY (Applicable to the State of Alaska)	Time period listed above.	All of the provisions of the full warranty above and the exclusions listed below apply.	Costs of the technician's travel to the home and any costs for pick up and delivery of the appliance required because of service.

Your appliance is warranted by Frigidaire Company, a division of White Consolidated Industries, Inc. We authorize no person to change or add to any of our obligations under this warranty. Our obligations for service and parts under this warranty must be performed by Frigidaire Company Consumer Services or an authorized Tappan servicer.

*NORMAL RESPONSIBILITIES OF THE CONSUMER

This warranty applies only to products in ordinary household use, and the consumer is responsible for the items listed below:

1. Proper use of the appliance in accordance with instructions provided with the product.
2. Proper installation by an authorized servicer in accordance with instructions provided with the appliance and in accordance with all local plumbing, electrical and/or gas codes.
3. Proper connection to a grounded power supply of sufficient voltage, replacement of blown fuses, repair of loose connections or defects in house wiring.
4. Expenses for making the appliance accessible for servicing, such as removal of trim, cupboards, shelves, etc., which are not a part of the appliance when it was shipped from the factory.
5. Damages to finish after installation.
6. Replacement of light bulbs and/or fluorescent tubes (on models with these features).

EXCLUSIONS

This warranty does not cover the following:

1. CONSEQUENTIAL OR INCIDENTAL DAMAGES SUCH AS PROPERTY DAMAGE AND INCIDENTAL EXPENSES RESULTING FROM ANY BREACH OF THIS WRITTEN OR ANY IMPLIED WARRANTY.
Note: Some states do not allow the exclusion or limitation of incidental or consequential damages, so this limitation or exclusion may not apply to you.
2. Service calls which do not involve malfunction or defects in workmanship or material, or for appliances not in ordinary household use. The consumer shall pay for such service calls.
3. Damages caused by services performed by persons other than authorized Tappan servicers; use of parts other than Frigidaire Company Genuine Renewal Parts; obtained from persons other than such servicers; or external causes such as abuse, misuse, inadequate power supply or acts of God.
4. Products with original serial numbers that have been removed or altered and cannot be readily determined.

IF YOU NEED SERVICE

Keep your bill of sale, delivery slip, or some other appropriate payment record. The date on the bill establishes the warranty period should service be required. If service is performed, it is in your best interest to obtain and keep all receipts. This written warranty gives you specific legal rights. You may also have other rights that vary from state to state. Service under this warranty must be obtained by following these steps, in order:

1. Contact Frigidaire Company Consumer Services or an authorized Tappan servicer.
2. If there is a question as to where to obtain service, call or write our Consumer Relations Department at:

Tappan
P.O. Box 7181
Dublin, Ohio 43017
(800) 944-9044



Product features or specifications as described or illustrated are subject to change without notice. All warranties are made by White Consolidated Industries, Inc. This warranty applies only in the 50 states of the U.S.A. and Puerto Rico.