



# Free-Standing, Slide-In, and Drop-In Electric Ranges

**Safety Instructions** ..... 2-5

**Operating Instructions**

Kitchen Timer ..... 11

Oven ..... 10-27

    Adjust Oven Thermostat ..... 15

    Baking or Roasting ..... 13

    Broiling, Broiling Guide ..... 14

    Controls ..... 10

    Convection Oven ..... 16, 17

    Preheating ..... 13

    Probe ..... 18

    Sabbath Feature ..... 27

    Self-Cleaning ..... 22, 23

    Slow Cook and Warming Features ..... 20

    Special Features ..... 25, 26

    Steam Clean ..... 24

    Timed Baking and Roasting ..... 19

    Warming Drawer ..... 21

Surface Units ..... 6-9

    Bridge Burner ..... 7

    Cookware ..... 9

    Glass Cooktop ..... 8

    Warming Zone ..... 7

**Care and Cleaning**

Aluminum Foil ..... 3, 4, 5, 13

Control Knobs ..... 28

Control Panel ..... 28

Glass Cooktop ..... 34, 35

Lift-Off Oven Door ..... 30, 31

Light ..... 29

Oven Floor ..... 33

Oven Heating Elements ..... 33

Racks ..... 31

Removable Warming Drawer Pan ..... 33

Storage Drawer ..... 33

Surfaces ..... 28

Vent ..... 33

**Troubleshooting Tips** ..... 36-40

**Accessories** ..... 41

**Consumer Support**

Consumer Support ..... Back Cover

Warranty ..... 43

**Write the model and serial numbers here:**

**Model #** \_\_\_\_\_

**Serial #** \_\_\_\_\_

You can find them on a label behind the drawer or behind the lower oven door on the front of the range frame.

**Owner's Manual**

Quick Set V,  
Quick Set VI

**Español**

For a Spanish version of this manual, visit our Website at [GEAppliance.com](http://GEAppliance.com).

Para consultar una version en español de este manual de instrucciones, visite nuestro sitio de internet [GEAppliance.com](http://GEAppliance.com).

In Canada:  
[www.GEAppliances.ca](http://www.GEAppliances.ca)

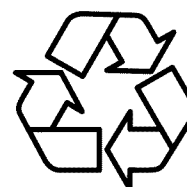

Printed on  
Recycled Paper

# IMPORTANT SAFETY INFORMATION. READ ALL INSTRUCTIONS BEFORE USING.

## ⚠ WARNING

Read all safety instructions before using the product. Failure to follow these instructions may result in fire, electric shock, serious injury or death.

## ANTI-TIP DEVICE



### ⚠ WARNING

**Tip-Over Hazard**

A child or adult can tip the range and be killed. Verify the anti-tip bracket has been properly installed and engaged. Ensure the anti-tip bracket is re-engaged when the range is moved. Do not operate the range without the anti-tip bracket in place and engaged. Failure to follow these instructions can result in death or serious burns to children or adults.

To reduce the risk of tipping the range, the range must be secured by a properly installed anti-tip bracket. See installation instructions shipped with the bracket for complete details before attempting to install.

### For Freestanding and Slide-In Ranges

To check if the bracket is installed and engaged properly, look underneath the range to see that the rear leveling leg is engaged in

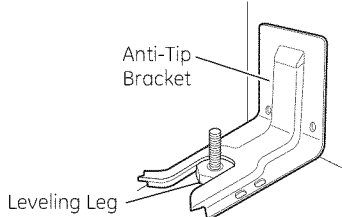

### Freestanding and Slide-In Ranges

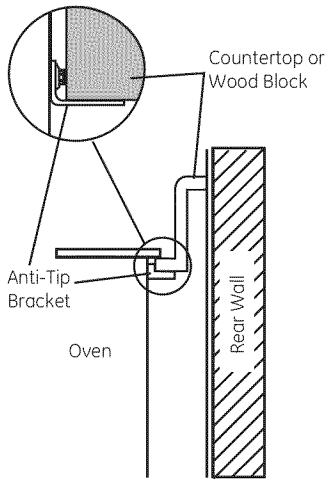

### Drop-In Ranges

the bracket. On some models, the storage drawer or kick panel can be removed for easy inspection. If visual inspection is not possible, slide the range forward, confirm the anti-tip bracket is securely attached to the floor or wall, and slide the range back so the rear leveling leg is under the anti-tip bracket.

If the range is pulled from the wall for any reason, always repeat this procedure to verify the range is properly secured by the anti-tip bracket.

Never completely remove the leveling legs or the range will not be secured to the anti-tip device properly.

### For Drop-In Ranges

To check if the bracket is installed and engaged properly, slide the range forward, confirm the anti-tip bracket is securely attached to the rear of the range, and slide the range back so that the anti-tip bracket slides just under the countertop or wood block attached to the rear wall.

If you did not receive an anti-tip bracket with your purchase, call 1.800.626.8774 to receive one at no cost (in Canada, call 1.800.561.3344). For installation instructions of the bracket, visit [GEAppliances.com](http://GEAppliances.com) (in Canada, [GEAppliances.ca](http://GEAppliances.ca)).

## ⚠ WARNING

## IMPORTANT SAFETY NOTICE

The California Safe Drinking Water and Toxic Enforcement Act requires the Governor of California to publish a list of substances known to the state to cause cancer, birth defects or other reproductive harm, and requires businesses to warn customers of potential exposure to such substances.

The fiberglass insulation in self-clean ovens gives off a very small amount of carbon monoxide during the cleaning cycle. Exposure can be minimized by venting with an open window or using a ventilation fan or hood.

## **⚠ WARNING** GENERAL SAFETY INSTRUCTIONS

- Use this appliance for its intended purpose as described in this Owner's Manual.
- Be sure your appliance is properly installed and grounded by a qualified installer in accordance with the provided installation instructions.
- Do not attempt to repair or replace any part of your range unless it is specifically recommended in this manual. All other servicing should be transferred to a qualified technician.
- Before performing any service, unplug the range or disconnect the power supply at the household distribution panel by removing the fuse or switching off the circuit breaker.
- Do not leave children alone—children should not be left alone or unattended in an area where an appliance is in use. They should never be allowed to climb, sit or stand on any part of the appliance.
- **CAUTION:** Do not store items of interest to children above a range or on the backguard of a range—children climbing on the range to reach items could be seriously injured.
- Use only dry pot holders—moist or damp pot holders on hot surfaces may result in burns from steam. Do not let pot holders touch hot surface units or heating elements. Do not use a towel or other bulky cloth in place of pot holders.
- Never use your appliance for warming or heating the room.
- Do not touch the surface units, the heating elements or the interior surface of the oven. These surfaces may be hot enough to burn even though they are dark in color. During and after use, do not touch, or let clothing or other flammable materials contact the surface units, areas nearby the surface units or any interior area of the oven; allow sufficient time for cooling first. Other surfaces of the appliance may become hot enough to cause burns. Potentially hot surfaces include the cooktop, areas facing the cooktop, oven vent opening, surfaces near the opening and crevices around the oven door.
- Do not heat unopened food containers. Pressure could build up and the container could burst, causing an injury.
- Do not use aluminum foil to line the drip pans or anywhere in the oven, except as described in this manual. Misuse could result in damage to the range and shock or fire hazard.
- Avoid scratching or impacting glass doors, cooktops or control panels. Doing so may lead to glass breakage. Do not cook on a product with broken glass. Shock, fire or cuts may occur.
- Cook meat and poultry thoroughly—meat to at least an internal temperature of 160°F and poultry to at least an internal temperature of 180°F. Cooking to these temperatures usually protects against foodborne illness.

## **⚠ WARNING** KEEP FLAMMABLE MATERIALS AWAY FROM THE RANGE.

- Do not store or use flammable materials in an oven or near the cooktop, including paper, plastic, pot holders, linens, wall coverings, curtains, drapes and gasoline or other flammable vapors and liquids.
- Never wear loose-fitting or hanging garments while using the appliance. These garments may ignite if they contact hot surfaces, causing severe burns.
- Do not let cooking grease or other flammable materials accumulate in or near the range. Grease in the oven or on the cooktop may ignite.
- Clean ventilating hoods frequently. Grease should not be allowed to accumulate on the hood or filter.

## **⚠ WARNING** IN THE EVENT OF A FIRE, TAKE THE FOLLOWING STEPS TO PREVENT THE FIRE FROM SPREADING:

- Do not use water on grease fires. Never pick up a flaming pan. Turn the controls off. Smother a flaming pan on a surface unit by covering the pan completely with a well-fitting lid, cookie sheet or flat tray. Use a multi-purpose dry chemical or foam-type fire extinguisher.
- If there is a fire in the oven during baking, smother the fire by closing the oven door and turning the oven off or by using a multi-purpose dry chemical or foam-type fire extinguisher.
- If there is a fire in the oven during self-clean, turn the oven off and wait for the fire to go out. Do not force the door open. Introduction of fresh air at self-clean temperatures may lead to a burst of flame from the oven. Failure to follow this instruction may result in severe burns.

# IMPORTANT SAFETY INFORMATION. READ ALL INSTRUCTIONS BEFORE USING.

---

## **⚠ WARNING** COOKTOP SAFETY INSTRUCTIONS

---

- Never leave the surface units unattended at medium or high heat settings. Boilovers cause smoking and greasy spillovers that may catch on fire.
- Never leave oil unattended while frying. If allowed to heat beyond its smoking point, oil may ignite, resulting in fire that may spread to surrounding cabinets. Use a deep fat thermometer whenever possible to monitor oil temperature.
- To avoid oil spillover and fire, use a minimum amount of oil when shallow pan-frying and avoid cooking frozen foods with excessive amounts of ice.
- Use proper pan size—select cookware having flat bottoms large enough to cover the surface heating element. The use of undersized cookware will expose a portion of the surface unit to direct contact and may result in ignition of clothing. Proper relationship of cookware to surface unit will also improve efficiency.
- Only certain types of glass, glass/ceramic, earthenware or other glazed containers are suitable for cooktop service; others may break because of the sudden change in temperature.
- To minimize the possibility of burns, ignition of flammable materials and spillage, the handle of a container should be turned toward the center of the range without extending over nearby surface units.
- When preparing flaming foods under a hood, turn the fan on.
- If power is lost to an electric cooktop while a surface unit is ON, the surface unit will turn back ON as soon as power is restored. In the event of power loss, failure to turn all surface unit knobs to the OFF position may result in ignition of items on or near the cooktop leading to serious injury or death.

## **⚠ WARNING** RADIANT COOKTOP SAFETY INSTRUCTIONS

(some models)

- Use care when touching the cooktop. The glass surface of the cooktop will retain heat after the controls have been turned off.
- Do not cook on a broken cooktop. If glass cooktop should break, cleaning solutions and spillovers may penetrate the broken cooktop and create a risk of electric shock. Contact a qualified technician immediately.
- Avoid scratching the glass cooktop. The cooktop can be scratched with items such as knives, sharp instruments, rings or other jewelry and rivets on clothing.
- Do not place or store items that can melt or catch fire on the glass cooktop, even when it is not being used. If the cooktop is inadvertently turned on, they may ignite. Heat from the cooktop or oven vent after it is turned off may cause them to ignite also.
- Use CERAMA BRYTE® ceramic Cooktop Cleaner and CERAMA BRYTE® Cleaning Pad to clean the cooktop. Wait until the cooktop cools and the indicator light goes out before cleaning. A wet sponge or cloth on a hot surface can cause steam burns. Some cleaners can produce noxious fumes if applied to a hot surface. **NOTE:** Sugar spills are an exception. They should be scraped off while still hot using an oven mitt and a scraper. See the Cleaning the glass cooktop section for detailed instructions.
- Read and follow all instructions and warnings on the cleaning cream label.

## **⚠ WARNING** COIL COOKTOP SAFETY INSTRUCTIONS

(some models)

- Do not immerse or soak the removable surface units. Do not put them in a dishwasher. Do not self-clean the surface units in an oven. Doing so may cause them to fail, presenting a burn or fire hazard.
- To avoid the possibility of a burn or electric shock, always be certain that the controls for all surface units are at the OFF position and all coils are cool before attempting to lift or remove a coil surface unit.
- Be sure the drip pans are not covered and are in place. Their absence during cooking could damage range parts and wiring.
- Do not use aluminum foil to line drip pans. Foil can trap heat or melt, resulting in damage to the product and a shock or fire hazard.

## **▲ WARNING** OVEN SAFETY INSTRUCTIONS

- Stand away from the range when opening the oven door. Hot air or steam which escapes can cause burns to hands, face and/or eyes.
- Keep the oven vent unobstructed.
- Keep the oven free from grease buildup. Grease in the oven may ignite.
- Place oven racks in desired location while oven is cool. If rack must be moved while oven is hot, do not let pot holder contact hot heating element in oven.
- When using cooking or roasting bags in the oven, follow the manufacturer's directions.
- Pull the oven rack to the stop-lock position when loading and unloading food from the oven. This helps prevent burns from touching hot surfaces of the door and oven walls.
- Do not leave items such as paper, cooking utensils or food in the oven when not in use. Items stored in an oven can ignite.
- Do not use aluminum foil to line the oven bottom. Foil may trap or reflect heat, leading to a shock or fire hazard.

## **▲ WARNING** SELF-CLEANING OVEN SAFETY INSTRUCTIONS

*(Some models)*

The self-cleaning feature operates the oven at temperatures high enough to burn away food soils in the oven. Follow these instructions for safe operation.

- Before operating the self-clean cycle, remove pans, shiny metal oven racks and other utensils from the oven. Only gray porcelain-coated oven racks may be left in the oven. Do not use self-clean to clean other parts, such as drip pans or bowls.
- Before operating the self-clean cycle, wipe grease and food soils from the oven. Excessive amount of grease may ignite, leading to smoke damage to your home.
- If the self-cleaning mode malfunctions, turn the oven off and disconnect the power supply. Have it serviced by a qualified technician.
- Do not clean the door gasket. The door gasket is essential for a good seal. Care should be taken not to rub, damage or move the gasket.
- Do not use oven cleaners. No commercial oven cleaner or oven liner protective coating of any kind should be used in or around any part of the oven.

## **▲ WARNING** WARMING DRAWER SAFETY INSTRUCTIONS *(some models)*

- The purpose of the warming drawer is to hold hot cooked foods at serving temperature. Bacteria will grow in food while it is below 140°F. Do not put cold food in warming drawer. Do not heat food for more than 2 hours. Failure to follow these instructions may result in foodborne illness.
- Do not leave paper products, plastics, canned food or combustible materials in the drawer. They may ignite.
- Do not touch the heating element or the interior surface of the drawer. These surfaces may be hot enough to cause burns.
- Use care when opening the drawer. Open the drawer a crack and let hot air or steam escape before removing or replacing food. Hot air or steam that escapes can cause burns to hands, face and/or eyes.
- Do not use aluminum foil to line the lower drawer. The foil will trap heat below, and upset the performance of the oven. Foil can melt and permanently damage the drawer bottom. Damage from improper use of aluminum foil is not covered by the product warranty.

## Using the surface units.

### **WARNING**

**FIRE HAZARD:** Never leave the range unattended with the cooktop on medium or high settings. Keep flammable items away from the cooktop. Turn off all controls when done cooking. Failure to follow these instructions can result in fire, serious injury or death.

Throughout this manual, features and appearance may vary from your model.

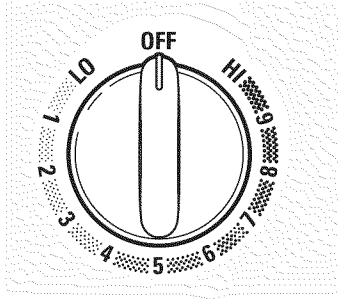

### How to Set

Push the knob in and turn in either direction to the setting you want.

A surface ON indicator light will glow when any surface unit is on

### For glass cooktop surfaces:

A **HOT COOKTOP** indicator light will:

- come on when the unit is hot to the touch.
- stay on even after the unit is turned off.
- stay on until the unit is cooled to approximately 150°F.

At both OFF and HI the control clicks into position. You may hear slight clicking sounds during cooking, indicating the control is maintaining your desired setting.

Be sure you turn the control knob to OFF when you finish cooking.

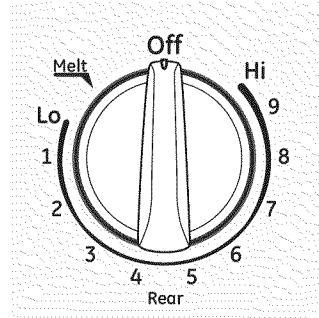

**Melt** setting (on some models) will melt chocolate or butter. **Simmer** setting (on some models) will simmer sauces.

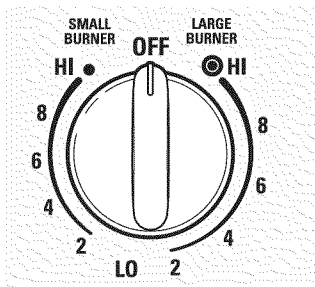

### Dual and Triple Surface Units and Control Knobs (on some models)

The surface unit has 2 or 3 cooking sizes to select from so you can match the size of the unit to the size of the cookware you are using.

Models with a Dual-Ring surface element only

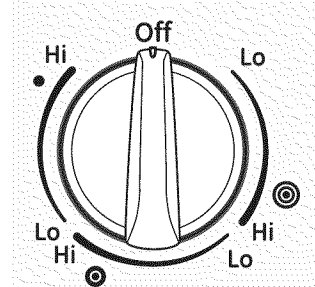

Models with a Tri-Ring surface element only.

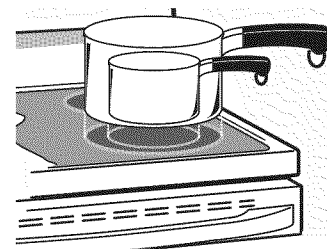

Throughout this manual, features and appearance may vary from your model.

Models with a bridge burner only.

### Using the Bridge Burner (on some models)

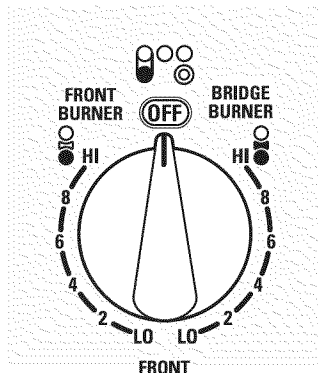

To use the bridge burner, turn the left-front control knob to the BRIDGE BURNER settings.

For full bridge surface unit operation, also turn on the left-rear surface unit.

To use only the front surface unit, turn the control knob to the FRONT BURNER settings.

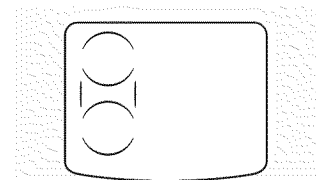

Warming Zone

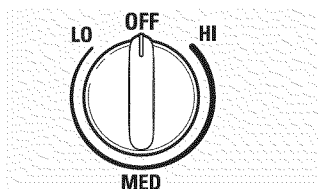

### Using the Warming Zone

#### **WARNING**

**FOOD POISON HAZARD:** Bacteria may grow in food at temperatures below 140°F.

- Always start with hot food. Do not use warm setting to heat cold food.
- Do not use warm setting for more than 2 hours.

Failure to follow these instructions may result in foodborne illness.

The **WARMING ZONE**, located in the back center of the glass surface, will keep hot, cooked food at serving temperature. Always start with hot food. Do not use to heat cold food. Placing uncooked or cold food on the **WARMING ZONE** could result in foodborne illness.

Push and turn the control knob to any desired setting.

For best results, all foods on the **WARMING ZONE** should be covered with a lid or aluminum foil. When warming pastries or breads, the cover should be vented to allow moisture to escape.

Use the lowest setting for breads and pastries. Use a medium setting for vegetables, sauces, stews, cream soups, butter and chocolate. Use the highest setting for soups (liquid) and hot beverages. These initial suggested settings are for reference only. The temperature, type and amount of food, type of pan, and the time held will affect the quality of the food.

Always use pot holders or oven mitts when removing food from the **WARMING ZONE**, since cookware and plates will be hot.

**NOTE:** The surface warmer will not glow red like the cooking elements.

## Using the surface units.

---

### Home Canning Tips

Be sure the canner is centered over the surface unit.

Make sure the canner is flat on the bottom.

To prevent burns from steam or heat, use caution when canning.

Use recipes and procedures from reputable sources. These are available from manufacturers such as Ball® and Kerr® and the Department of Agriculture Extension Service.

Flat-bottomed canners are recommended. Use of water bath canners with rippled bottoms may extend the time required to bring the water to a boil.



Never cook directly on the glass.  
Always use cookware.



Always place the pan in the center of the surface unit you are cooking on.

### For Models With a Radiant Glass Cooktop

The radiant cooktop features heating units beneath a smooth glass surface.

NOTE: A slight odor is normal when a new cooktop is used for the first time. It is caused by the heating of new parts and insulating materials and will disappear in a short time.

NOTE: On models with light-colored glass cooktops, it is normal for the cooking zones to change color when hot or cooling down. This is temporary and will disappear as the glass cools to room temperature.

The surface unit will cycle on and off to maintain your selected control setting.

It is safe to place hot cookware on the glass surface even when the cooktop is cool.

Even after the surface units are turned off, the glass cooktop retains enough heat to continue cooking. To avoid overcooking, remove pans from the surface units when the food is cooked. Avoid placing anything on the surface unit until it has cooled completely.



Do not slide cookware across the cooktop because it can scratch the glass—the glass is scratch-resistant, not scratchproof.

- Water stains (mineral deposits) are removable using the cleaning cream or full-strength white vinegar.
- Use of window cleaner may leave an iridescent film on the cooktop. The cleaning cream will remove this film.
- Don't store heavy items above the cooktop. If they drop onto the cooktop, they can cause damage.
- Do not use the surface as a cutting board.

### Temperature Limiter on Radiant Glass Cooktops

Every radiant surface unit has a temperature limiter.

The temperature limiter protects the glass cooktop from getting too hot.

The temperature limiter may cycle the surface units off for a time if:

- the pan boils dry.
- the pan bottom is not flat.
- the pan is off-center.
- there is no pan on the unit.



# Selecting types of cookware for radiant glass cooktop models.

The following information will help you choose cookware which will give good performance on glass cooktops.

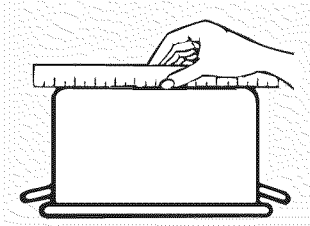

Check pans for flat bottoms by using a straight edge.

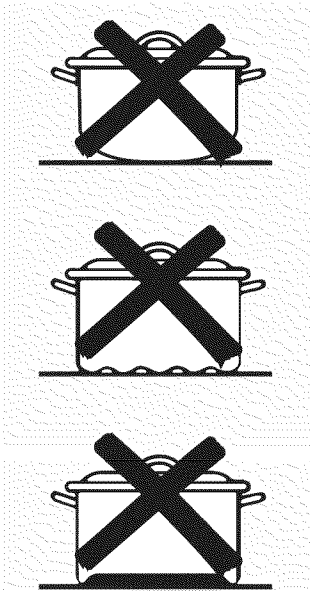

Pans with rounded, curved, ridged or warped bottoms are not recommended.

## **Stainless Steel:**

*recommended*

## **Aluminum:**

*heavy weight recommended*

Good conductivity. Aluminum residues sometimes appear as scratches on the cooktop but can be removed if cleaned immediately. Because of its low melting point, thin weight aluminum should not be used.

## **Copper Bottom:**

*recommended*

Copper may leave residues which can appear as scratches. The residues can be removed, as long as the cooktop is cleaned immediately. However, do not let these pots boil dry. Overheated metal can bond to glass cooktops. An overheated copper bottom pot will leave a residue that will permanently stain the cooktop if not removed immediately.

## **Porcelain Enamel on Cast Iron:**

*recommended if bottom of pan is coated*

## **Porcelain Enamel on Steel:**

*not recommended*

Heating empty pans can cause permanent damage to cooktop glass. The enamel can melt and bond to the ceramic cooktop.

## **Glass-ceramic:**

*not recommended*

Poor performance. Will scratch the surface.

## **Stoneware:**

*not recommended*

Poor performance. May scratch the surface.

## **Cast Iron:**

*not recommended*—unless designed specifically for glass cooktops

Poor conductivity and slow to absorb heat. Will scratch the cooktop surface.

**NOTE:** Follow all cookware manufacturer's recommendations when using any type of cookware on the ceramic cooktop.

## **For Best Results**

- Place only dry pans on the surface elements. Do not place lids on the surface elements, particularly wet lids. Wet pans and lids may stick to the surface when cool.
- Do not use woks that have support rings. This type of wok will not heat on glass surface elements.
- We recommend that you use only a flat-bottomed wok. They are available at your local retail store. The bottom of the wok should have the same diameter as the surface element to ensure proper contact.
- Some special cooking procedures require specific cookware such as pressure cookers or deep-fat fryers. All cookware must have flat bottoms and be the correct size.



# Using the oven controls.

Throughout this manual, features and appearance may vary from your model.



**BROIL HI/LO Pad**  
Touch this pad to select the broil function. See the *How to Set the Oven for Broiling* section.



**BAKE Pad**  
Touch this pad to select the bake function. See the *How to Set the Oven for Baking* section.

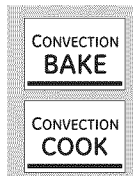

**CONVECTION COOK or CONVECTION BAKE Pad**  
Uses a fan to circulate air in the oven. See the *Using the convection oven* section.



**CONVECTION ROAST Pad**  
Touch to roast large tender cuts of meat. See the *Using the convection oven* section.



**WARM Pad**  
Touch to keep cooked foods warm. See the *How to Set the Oven for Warming* section.



**SLOW COOK Pad**  
Touch for long hours of unattended cooking. See the *How to Set the Oven for Slow Cook* section.



**PROBE Pad**  
Touch when using the probe to automatically cook to a desired internal food temperature. See the *Using the Probe* section.



**SELF CLEAN Pad**  
Touch to self-clean the oven. See the *Using the Self-Cleaning Oven* section.



**STEAM CLEAN Pad**  
Touch this pad for easier cleaning of light soiling off the oven cavity or door. See the *Using steam clean* section.



**CLEAR/OFF Pad**  
Touch to cancel **ALL** oven operations except the clock and timer.



**START Pad**  
Must be touched to start any cooking or cleaning function.



**OVEN LIGHT Pad**  
Touch to turn the oven lights on or off.

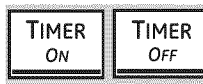

**TIMER ON/OFF Pads**  
Touch to set the kitchen timer. See the *Using the Kitchen Timer* section



**COOK TIME TIME Pad**  
Touch this pad and then touch the number pads to set the amount of time you want your food to cook. The oven will shut off when the cooking time has run out.



**DELAY START Pad**  
Touch this pad to set the oven to start automatically at a time you set.

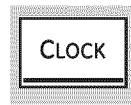

**CLOCK Pad**  
**NOTE:** When setting times, you are setting hours and minutes only. The lowest time you can set is one minute.

The clock must be set to the correct time of day for the automatic oven timing functions to work properly. The time of day cannot be changed during a timed baking or self-cleaning cycle.

See *To set the clock* section.

**If your oven was set for a timed oven operation and a power outage occurred,** the clock and all programmed functions must be reset. **The time of day will flash in the display when there has been a power outage.**



**WARMING DRAWER pad**  
The warming drawer will keep hot, cooked foods at serving temperature. Always start with hot food. See the *Using the warming drawer* section.



**CONTROL LOCKOUT or RANGE LOCKOUT**  
The control pads can be locked so they cannot be activated when touched (Control Lockout). Some models have Range Lockout which will also turn off the surface units. See the *How to Lock Out the Controls* section.



## To Set the Clock

The clock must be set to the correct time of day for the **Delay Start** functions to work properly. The time of day cannot be changed during a delayed cooking or a delayed self-cleaning cycle.

- 1 Touch the **CLOCK** pad.
- 2 Touch the number pads until the correct time of day is shown in the display. If the number pads are not touched within one minute after you touch the **CLOCK** pad, the display reverts to the original setting. If this happens, touch the **CLOCK** pad and enter the time of day.

- 3 Touch the **START** pad until the time of day shows in the display. This enters the time and starts the clock.

To check the time of day when the display is showing other information, touch the **CLOCK** pad. The time of day shows until another pad is touched. To change the time format or turn off the clock display, see the *Special Features* section.

## To Set the Kitchen Timer



The Kitchen Timer is in hours and minutes.

The Kitchen Timer does not control oven operations. The maximum setting on the Kitchen Timer is 9 hours and 59 minutes.

- 1 Touch the **TIMER ON** pad.
- 2 Touch the number pads until the amount of time you want shows in the display. For example, to set 2 hours and 45 minutes, touch **2**, **4** and **5** in that order. If you make a mistake, touch the **TIMER OFF** pad and begin again.

- 3 Touch the **START** pad. After touching the **START** pad, **SET** disappears; this tells you the time is counting down, although the display does not change

until one minute has passed. Seconds will not be shown in the display until the last minute is counting down.

- 4 When the kitchen timer reaches :00, the control will beep 3 times followed by one beep every 6 seconds until the **TIMER OFF** pad.

The 6-second tone can be cancelled by following the steps in the *Special features* of your oven control section under *Tones at the End of a Timed Cycle*.

## To Reset the Kitchen Timer

If the display is still showing the time remaining, you may change it by touching the **TIMER ON** pad, then touching the number pads so that the time you want appears in the display.

If the remaining time is not in the display (clock, delay start or cooking time are in the display), recall the remaining time by touching the **TIMER ON** pad and then touch the number pads to enter the new time you want.



## To Cancel the Kitchen Timer

Touch the **TIMER OFF** pad.

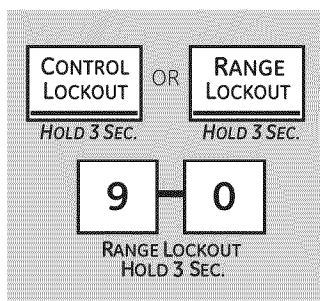

## How to Lock Out the Controls (on some models)

**Control Lockout** will allow you to lock out the touch pads so they cannot be activated when touched. Some models have **Range Lockout** which will also disable the surface units. Make sure all surface unit controls are turned off when using **Range Lockout**. Any surface unit that is set to an "on" position while the **Range Lockout** is enabled will automatically come on after the **Range Lockout** is disabled.

### To lock/unlock the controls:

- 1 Touch and hold the **Control Lockout** or **Range Lockout** pad for 3 seconds. For some models, you have to touch and hold the **9** and **0** pads at the same time for 3

seconds. A light will turn on indicating the controls are locked out.

- 2 To unlock the control, Touch and hold the **Control Lockout** or **Range Lockout** pad for 3 seconds. For some models, you have to touch and hold the **9** and **0** pads at the same time for 3 seconds. The light will turn off indicating the controls are unlocked.

When this feature is on, the touch pads will not respond except for the **Clear/Off** pad.

- The adjustment will be retained in memory after a power failure.

# Using the oven.

To avoid possible burns, place the racks in the desired position before you turn on the oven.

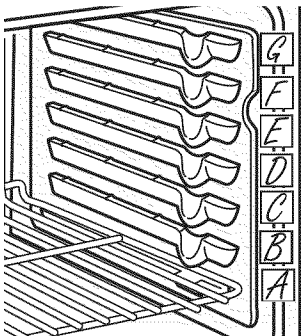

The number of rack positions may vary by model.

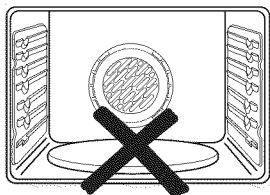

Never place cooking utensils, baking stones, foil, or any other items on the oven floor.

## Before you begin...

The racks have stops, so that when placed correctly on the supports, they will stop before coming completely out and will not tilt.

When placing and removing cookware, pull the rack out until it stops.

On some models, the bake heating element is under the oven floor. Never place cooking utensils, baking stones, foil, or any other items on the oven floor.

To remove a rack, pull it toward you, tilt the front end up and pull it out.

To replace, place the end of the rack (stop-locks) on the support, tilt up the front and push the rack in.

## CAUTION

**BURN HAZARD:** Avoid touching the hot door surface when using the oven rack in the lowest position. Always use 2 hands and 2 mitten pot holders to move the rack. Pull the rack out a few inches and then carefully grasp the sides of the rack to pull it out the rest of the way.

## Extension Rack

When placing and removing cookware, always pull the rack out by its upper front rail to its fully open position.

*Do not extend the rack quickly. Food may slide off the front of the rack.*

### To remove the rack:

- 1 Make sure the rack is pushed all the way into the oven so that side paddles on the rack from disengaged with oven support.
- 2 Slide the rack toward you to the bump (stop position) on the rack support.
- 3 Firmly grasp both sides of the rack frame and the sliding rack, tilt the front end up and pull it out.

**NOTE:** When handling the extension rack, do not allow the sliding portion to fall open. This can damage the slides.

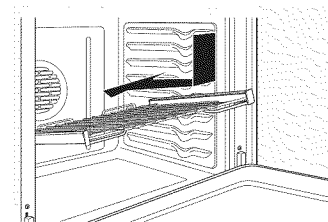
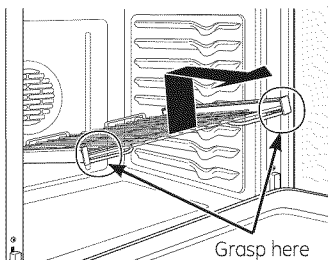
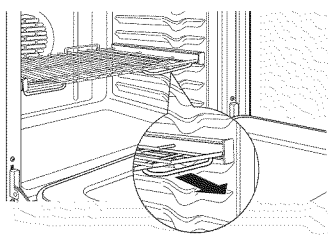
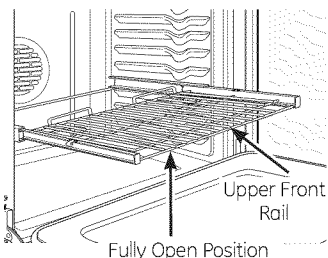

### To replace the rack:

- 1 Firmly grasp both sides of the rack frame and the sliding rack.
- 2 Place the curved end of the rack (stop-locks) onto the oven supports, tilt up the front of the rack and push it in as far as it will go.

## CAUTION

Never use the rack when its frame is not fully inserted in the oven and locked into position.

When the rack is properly installed and locked into position, the locking side paddles on the rack frame will click-lock into place on the oven supports. If the side paddles did not click-lock into position, repeat the steps above and make sure the side paddles have been correctly cleaned and lubricated. See *Extension Rack* in the *Care and cleaning* section.

## Aluminum Foil

Do not use aluminum foil to line oven bottoms. The foil will trap heat below and upset the performance of the oven. Foil can melt and permanently damage the oven bottom. Damage from improper use of aluminum foil is not covered by the product warranty.

Foil may be used to catch spills by placing a sheet on a lower rack, several inches below the food. Do not use more foil than necessary and never entirely cover an oven rack with aluminum foil. Keep foil at least 1-1/2" from oven walls to prevent poor heat circulation.

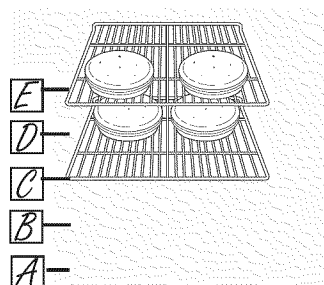

Rack position for baking 4 layer cakes.

## Preheating and Pan Placement

To avoid possible burns, place the racks in the desired position before you turn on the oven.

Preheat the oven if the recipe calls for it. Preheating is necessary for good results when baking cakes, cookies, pastries and breads.

If baking four cake layers at the same time, place two layers on rack C and two layers on rack E. Stagger pans on the rack so one is not directly above the other.

Baking results will be better if food is centered in the oven as much as possible. Angel food cake is the exception and should be placed on the bottom oven rack (position A). Follow package directions on prepackaged and frozen foods for pan placement. Pans should not touch each other or the walls of the oven. If you need to use two racks, stagger the pans so one is not directly above the other. Leave approximately 1½" between pans and from the front, back and sides of oven wall.

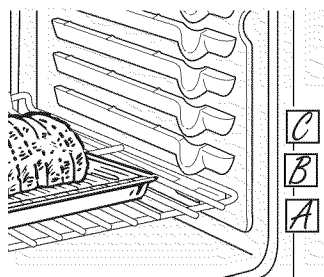

## How to Set the Oven for Baking or Roasting

- 1 Touch the **BAKE** pad.
- 2 Touch the number pads until the desired temperature is displayed.
- 3 Touch the **START** pad.

The oven will start automatically. The display will show the changing temperature starting at 100°F. (The temperature display will start to change once the oven temperature reaches 100°F.) When the oven reaches the selected temperature, the oven control will beep several times and the display will show the oven temperature.

**NOTE:** You may hear the convection fan (on some models) while the oven is preheating. The fan will stop after the oven is preheated and the display shows your set temperature. This is normal.

To change the oven temperature during the **BAKE** cycle, touch the **BAKE** pad and then the number pads to get the new temperature.

- 4 Check food for doneness at the minimum time on the recipe. Cook longer if necessary.
- 5 Touch the **CLEAR/OFF** pad when baking is finished, and then remove the food from the oven.

## Roasting Guide

	Meat		Oven Temp.	Internal Temp.
<b>Beef</b>	Rib Roast (4 to 8 lbs.)	Rare	325°F	145°F
	Bone-In and Boneless	Medium	325°F	160°F
	Beef Tenderloin (4 to 6 lbs.)	Rare	425°F	145°F
	Beef Tenderloin (2 to 3 lbs.)	Rare	425°F	145°F
<b>Pork</b>	Bone-In, Boneless (3 to 5 lbs.)		325°F	160°F
<b>Lamb</b>	Bone-In (5 to 9 lbs.)	Medium	325°F	165°F
	Boneless (4 to 7 lbs.)	Medium	375°F	165°F
<b>Poultry</b>	Whole Chicken (5 to 7 lbs.)		350°F	170°F
	Turkey, Whole*			
	Unstuffed (10 to 16 lbs.)		325°F	170°-180°F
	Unstuffed (18 to 24 lbs.)		325°F	170°-180°F
	Turkey Breast (4 to 6 lbs.)		325°F	170°F

\*Stuffed birds generally require 30-45 minutes additional roasting time. Shield legs and breast with foil to prevent overbrowning and drying of skin.

# Using the oven.

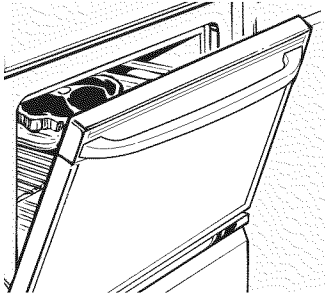

Leave the door open to the broil stop position. The door stays open by itself, yet the proper temperature is maintained in the oven.

## How to Set the Oven for Broiling

Use **LO Broil** to cook foods such as poultry or thick cuts of meat thoroughly without overbrowning them.

- 1 Place the meat or fish on a broiler grid in a broiler pan designed for broiling.
- 2 Follow suggested rack positions in the *Broiling Guide*.
- 3 Touch the **BROIL HI/LO** pad once for **HI Broil**.

To change to **LO Broil**, touch the **BROIL HI/LO** pad again.

- 4 Touch the **START** pad.
- 5 When broiling is finished, touch the **CLEAR/OFF** pad.

## Broiling Guide

Preheat the broiler for 2 minutes to improve performance.

The size, weight, thickness, starting temperature and your preference of doneness will affect broiling times. This guide is based on meats at refrigerator temperature.

† The U.S. Department of Agriculture says "Rare beef is popular, but you should know that cooking it to only 140°F means some food poisoning organisms may survive." (Source: *Safe Food Book. Your Kitchen Guide*. USDA Rev. June 1985.)

Food	Doneness	Type or Thickness	Rack Position*	Comments
Beef	Rare (140°F)	Steaks – 1" thick	E or F (food should be 1" to 3" from broil element)	Steaks less than 1" thick are difficult to cook rare. They cook through before browning. To prevent curling of meat, slash fat at 1" intervals.
	Medium (160°F)	Steaks – 3/4" to 1" thick	E (food should be 3" to 4" from broil element)	
	Well Done (170°F)	Steaks – 3/4" to 1" thick or Ground Beef Patties	D or E (food should be 3" to 5" from broil element)	
Chicken		Breast, boneless	C (food should be 8" to 9" from broil element)	Broil skin-side-down first.
		Breast, bone-in	C (food should be 7" to 8" from broil element)	
Fish Fillets		1/2" to 1" thick	D or E (food should be 3" to 6" from broil element)	Handle and turn very carefully.
Pork Chops	Well Done (170°F)	3/4" thick	D (food should be 6" to 7" from broil element)	To prevent curling of meat, slash fat at 1" intervals.

\*For double ovens, use rack position A for the smaller, 2-rack-position oven.

If your range is connected to 208 volts, rare steaks may be broiled by preheating the broiler and positioning the oven rack one position higher.

## Adjust the oven thermostat—Do it yourself!

You may find that your new oven cooks differently than the one it replaced. Use your new oven for a few weeks to become more familiar with it. If you still think your new oven is too hot or too cold, you can adjust the thermostat yourself.

Do not use thermometers, such as those found in grocery stores, to check the temperature setting of your oven. These thermometers may vary 20–40 degrees.

NOTE: This adjustment will only affect baking and roasting temperatures; it will not affect broiling or self-cleaning temperatures. The adjustment will be retained in memory after a power failure.

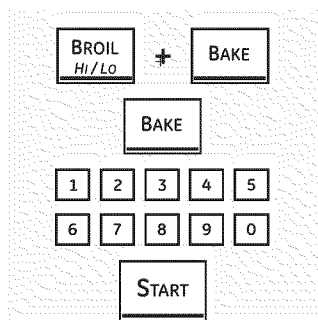

### To Adjust the Thermostat

- 1 Touch the **BROIL HI/LO** and **BAKE** pads at the same time until the display shows SF.
- 2 Touch the **BAKE** pad. A number shows in the display.

**Double Ovens:** To adjust the upper oven thermostat, touch the upper oven **BAKE** pad. To adjust the lower oven thermostat, touch the lower oven **BAKE** pad.

Touch the **BAKE** pad, again, to alternate between increasing and decreasing the oven temperature.

- 3 The oven temperature can be adjusted up to (+) 35°F hotter or (-) 35°F cooler. Touch the number pads the same way you read them. For example, to change the oven temperature 15°F, touch **1** and **5**.
- 4 When you have made the adjustment, touch the **START** pad to go back to the time of day display. Use your oven as you would normally.

## The type of margarine will affect baking performance!

Most recipes for baking have been developed using high-fat products such as butter or margarine (80% fat). If you decrease the fat, the recipe may not give the same results as with a higher-fat product.

Recipe failure can result if cakes, pies, pastries, cookies or candies are made with low-fat spreads. The lower the fat content of a spread product, the more noticeable these differences become.

Federal standards require products labeled “margarine” to contain at least 80% fat by weight. Low-fat spreads, on the other hand, contain less fat and more water. The high moisture content of these spreads affects the texture and flavor of baked goods. For best results with your old favorite recipes, use margarine, butter or stick spreads containing at least 70% vegetable oil.

## Using the convection oven. *(on some models)*

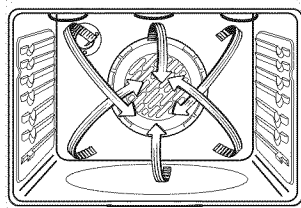

### Convection Fan Operation

In a convection oven, a fan circulates hot air over, under and around the food.

This circulating hot air is evenly distributed throughout the oven cavity. As a result, foods are evenly cooked and browned—often in less time with convection heat.

**NOTE:** On some models, the fan is designed to rotate in both directions, with a pause in between. This is normal.

The convection fan shuts off when the oven door is opened. **DO NOT** leave the door open for long periods of time while using convection cooking or you may shorten the life of the convection heating element.



### Convection Cook *(on some models)*

The convection oven comes with one convection cook mode and can be used for *Multi-Rack Convection Baking* or *1-Rack Convection Baking*.

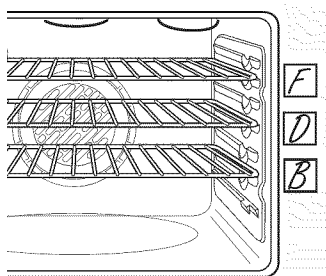

Multi-rack position.

### Multi-Rack Convection Baking *(on some models)*

Because heated air is circulated evenly throughout the oven, foods can be baked with excellent results using multiple racks.

Multi-rack baking may increase cook times slightly for some foods but the overall result is time saved. Cookies, muffins, biscuits and other quickbreads give very good results with multi-rack baking.

When baking on 3 racks, place one rack in the second (B) position, another rack in the fourth (D) position and the third rack in the sixth (F) position.

For two-rack baking, place one rack in the second (B) rack position. Place the other rack in the fifth (E) rack position.

### 1-Rack Convection Baking *(on some models)*

When convection baking with only 1 rack, place the food so that it is centered in the oven.

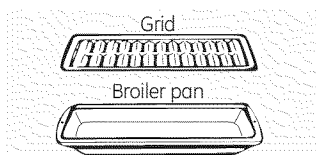

### Convection Roast *(on some models)*

■ Good for large tender cuts of meat, uncovered.

The convection fan circulates the heated air evenly over and around the food. Meat and poultry are browned on all sides as if they were cooked on a rotisserie. The heated air seals in juices quickly for a moist and tender product while, at the same time, creating a rich golden brown exterior.

When you are convection roasting, it is important that you use a broiler pan and grid for best convection roasting results. The pan is used to catch grease spills and the grid is used to prevent grease spatters.



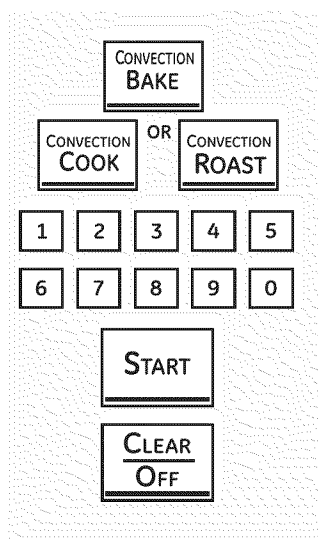

## How to Set the Oven for Convection Baking or Roasting

**1** Touch the **CONVECTION BAKE** pad (on some models) once for 1-rack convection baking. See the *1-Rack Convection Baking* section.

Touch the **CONVECTION BAKE** pad (on some models) twice for multi-rack convection baking. See the *Multi-Rack Convection Baking* section.

Touch the **CONVECTION COOK** pad for convection cooking (on some models). See the *Convection Cook* section for more information.

Touch the **CONVECTION ROAST** pad for convection roasting (on some models).

**2** Touch the number pads to set the oven temperature.

**3** Touch the **START** pad.

**NOTE:** If the Auto Recipe™ Conversion Feature is on, it will automatically reduce the set regular baking temperature by approximately 25°F to the appropriate convection temperature in convection bake mode. See *Auto Recipe™ Conversion* in the *Special Features* section.

To change the oven temperature, touch the **CONVECTION COOK**, **CONVECTION BAKE** or **CONVECTION ROAST** pad and then the number pads to set the new temperature.

When the oven starts to heat, the changing temperature, starting at 100°F, will be displayed. When oven reaches the temperature you set, 3 beeps will sound.

**4** Touch **CLEAR/OFF** pad when finished.

- You will hear a fan while cooking with convection. The fan will stop when the door is opened, but the heat will not turn off.

- You may hear the oven clicking during baking. This is normal.

When baking cookies, you will get the best results if you use a flat cookie sheet instead of a pan with low sides.

## Cookware for Convection Cooking

Before using your convection oven, check to see if your cookware leaves room for air circulation in the oven. If you are baking with several pans, leave space between them. Also, be sure the pans do not touch each other or the walls of the oven.

### Paper and Plastic

Heat-resistant paper and plastic containers that are recommended for use in regular baking can also be used for convection baking but should not be used at temperatures higher than the temperature recommended by the cookware manufacturer. Plastic cookware that is heat-resistant to temperatures of 400°F can also be used.

### Metal and Glass

Any type of cookware will work in your convection oven; however, metal pans heat the fastest and are recommended for convection baking.

- Darkened or matte-finished pans will bake faster than shiny pans.

- Glass or ceramic pans cook more slowly.

For recipes like oven-baked chicken, use a pan with low sides. Hot air cannot circulate well around food in a pan with high sides.

## Using the probe. *(on some models)*

For many foods, especially roasts and poultry, internal food temperature is the best test for doneness. The temperature probe takes the guesswork out of roasting by cooking foods to the exact doneness you want.

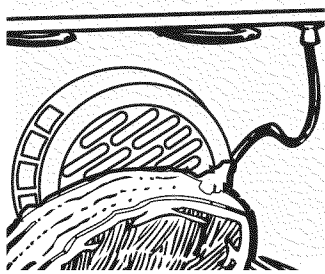

The temperature probe has a skewer-like probe at one end and a plug at the other end that goes into the outlet in the oven.

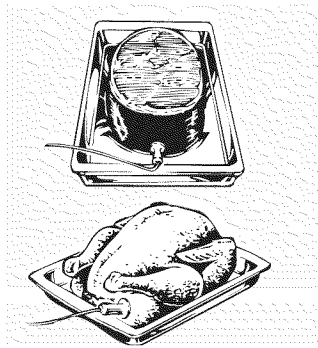

### CAUTION

To prevent burns, do not unplug the probe from the oven outlet until the oven has cooled.

Use of probes other than the one provided with this product may result in damage to the probe or oven control.

Use the handles of the probe and plug when inserting and removing them from the food and outlet.

- To avoid damaging your probe, do not use tongs to pull on the cable when removing it.
- To avoid breaking the probe, make sure food is completely defrosted before inserting.

After preparing the meat and placing it on a trivet or a broiler pan grid, follow these directions for proper probe placement.

Insert the probe completely into the meat. It should not touch bone, fat or gristle.

**NOTE:** Failure to fully insert the probe into the meat may result in poor cooking performance because the probe will sense the oven air vs. the food temperature.

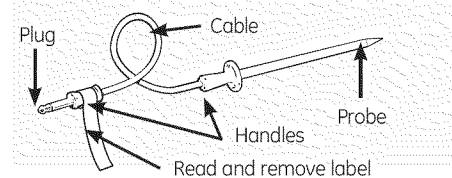

- Never leave your probe inside the oven during a self-cleaning or broil cycle.
- Do not store the probe in the oven.

For roasts with no bone, insert the probe into the meatiest part of the roast. For bone-in ham or lamb, insert the probe into the center of the lowest large muscle.

Insert the probe into the center of dishes such as meat loaf or casseroles.

Insert the probe into the meatiest part of the inner thigh from below and parallel to the leg of a whole turkey.

**NOTE:** Self-clean and Broil settings will not work if the temperature probe is plugged in.

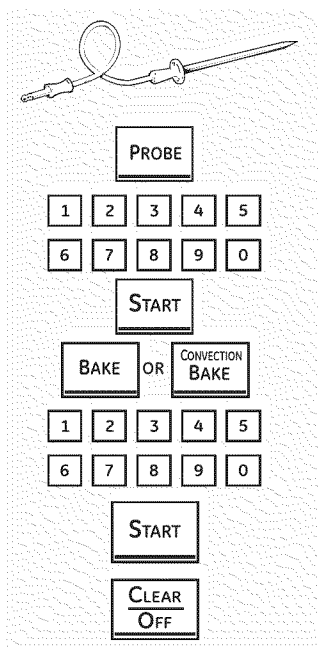

### How to Set the Oven For Baking/Roasting When Using the Probe

*(on some models)*

- 1 Insert the probe fully into the food.
- 2 Plug the probe into the outlet in the oven. Make sure it's pushed all the way in. Close the oven door. Make sure the probe cable is not touching the broil element.
- 3 Touch the **PROBE** pad. Display will show "Set Probe Temp."
- 4 Touch the number pads to set the desired internal food or meat temperature. The maximum internal temperature for the food that you can set is 200°F.
- 5 Touch the **START** pad.
- 6 Touch the **BAKE** or **CONVECTION** pad.
- 7 Touch the number pads to set the desired oven temperature.
- 8 Touch the **START** pad.

The display will flash if the probe is inserted into the outlet and you have not set a probe temperature and touched the **START** pad.

Touch the **PROBE** pad to recall the probe temperature or **BAKE** or **CONVECTION** pad to recall the oven temperature. For the probe temperature, after the internal temperature of the food reaches 100°F, the changing temperature will be shown in the display.

- 9 When the internal temperature of the food reaches the number you have set, the probe and the oven turn off and the oven control signals. To stop the signal, touch the **CLEAR/OFF** pad. Use hot pads to remove the probe from the food. Do not use tongs to pull on it—they might damage it.

- If the probe is removed from the oven while probe cooking, the oven will not automatically turn off.

To change the oven temperature during the Bake/Roast cycle, touch the **BAKE** or **CONVECTION** pad and then the number pads to set the new temperature.

- You can use the **Kitchen Timer** even though you cannot use timed oven operations while using the probe.

# Using the timed baking and roasting features. *(on some models)*

**NOTE:** Foods that spoil easily—such as milk, eggs, fish, stuffings, poultry and pork—should not be allowed to sit for more than 1 hour before or after cooking. Room temperature promotes the growth of harmful bacteria. Be sure that the oven light is off because heat from the bulb will speed harmful bacteria growth.

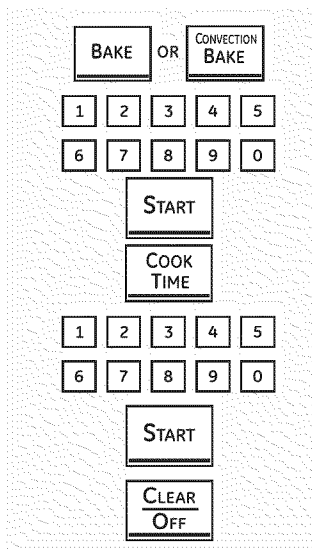

## How to Set an Immediate Start and Automatic Stop

The oven will turn on immediately and cook for a selected length of time. At the end of the cooking time the oven will turn off automatically.

- 1 Touch the **BAKE** or **CONVECTION BAKE** pad or other desired cooking function.
- 2 Touch the number pads to set the desired oven temperature.
- 3 Touch the **START** pad.
- 4 Touch the **COOK TIME** pad.

**NOTE:** If your recipe requires preheating, you may need to add additional time to the length of the cooking time.

- 5 Touch the number pads to set the desired length of cooking time. The minimum cooking time you can set is 1 minute.  
The oven temperature that you set and the cooking time that you entered will be in the display.

- 6 Touch the **START** pad.

The oven will turn **ON**, and the display will show the cooking time countdown and the changing temperature starting at 100°F. (The temperature display will start to change once the oven temperature reaches 100°F.) When the oven reaches the temperature you set, 3 beeps will sound.

The oven will continue to cook for the set amount of time, then turn off automatically.

- 7 Touch the **CLEAR/OFF** pad to clear the display if necessary. Remove the food from the oven. Remember, even though the oven turns off automatically, food left in the oven will continue cooking after the oven turns off.

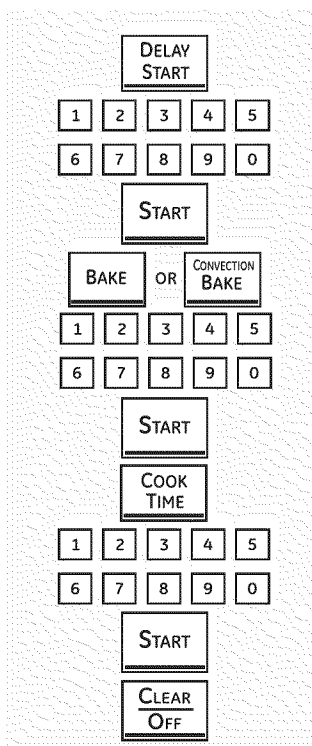

## How to Set a Delayed Start and Automatic Stop

The oven will turn on at the time of day you set, cook for a specific length of time and then turn off automatically.

Make sure the clock shows the correct time of day.

- 1 Touch the **DELAY START** pad.
- 2 Touch the number pads to set the time of day you want the oven to turn on and start cooking.
- 3 Touch the **START** pad.
- 4 Touch the **BAKE** or **CONVECTION BAKE** pad or other desired cooking function.
- 5 Touch the number pads to set the desired oven temperature.
- 6 Touch the **START** pad.
- 7 Touch the **COOK TIME** pad.

**NOTE:** If your recipe requires preheating, you may need to add additional time to the length of the cooking time.

- 8 Touch the number pads to set the desired length of cooking time. The minimum cooking time you can set is 1 minute.

The oven temperature that you set and the cooking time that you entered will be in the display.

- 9 Touch the **START** pad.

**NOTE:** If you would like to check the times you have set, touch the **DELAY START** pad to check the start time you have set or touch the **COOK TIME** pad to check the length of cooking time you have set.

When the oven turns **ON** at the time of day you set, the display will show the cooking time countdown and the changing temperature starting at 100°F. (The temperature display will start to change once the oven temperature reaches 100°F.) When the oven reaches the temperature you set, beeps will sound.

The oven will continue to cook for the set amount of time, then turn off automatically.

- 10 Touch the **CLEAR/OFF** pad to clear the display if necessary. Remove the food from the oven. Remember, even though the oven turns off automatically, food left in the oven will continue cooking after the oven turns off.

## Using the slow cook and warming features.

### ⚠ WARNING

**FOOD POISON HAZARD:** Bacteria may grow in food at temperatures below 140°F.

- Always start with hot food. Do not use warm settings to heat cold food.
- Do not warm food for more than 2 hours.

Failure to follow these instructions may result in foodborne illness.

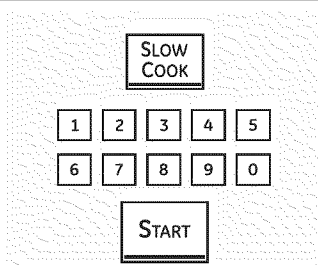

### How to Set the Oven For Slow Cook

Slow Cook is designed for long hours of unattended cooking.

- 1 Touch the **SLOW COOK** pad.
- 2 Display will show Poultry. To change to Meats, touch the **SLOW COOK** pad again. See the Slow Cook Guide below for proper setting. Use Meats if you are unsure which setting to use.

- 3 Touch the number pads to set the desired length of cooking time. The cooking time must be at least 3 hours, up to 11 hours 59 minutes.

- 4 Touch the **START** pad.

**NOTE:** If a power outage occurs while the oven is in Slow Cook, the range will shut off.

### Slow Cook Guide

Food	Quantity	Rack Position	Food Setting	Time (Hours)	Comments
<b>Beef</b>					
Chuck Roast	3-3½ lbs.	C	Meats	HI 5-6 hrs. LO 8-10 hrs.	Add 1/2 cup liquid.
Beef Ribs	3½-4 lbs.	C	Meats	HI 3-4 hrs. LO 6-8 hrs.	Place ribs in a single layer.
<b>Poultry</b>					
Whole Chicken	4 lbs.	C	Poultry	HI 4-5 hrs. LO 7-9 hrs.	Add 1/2 cup liquid.
Chicken Pieces	8 pieces (approx. 3 lbs.)	C	Poultry	HI 3-4 hrs. LO 5-6 hrs.	Best submerged under a sauce to prevent surface drying.
<b>Pork</b>					
Boneless Blade Roast	3-4 lbs.	C	Meats	HI 5-6 hrs. LO 8-10 hrs.	Add 1/2-1 cup liquid.
Country Style Pork Ribs	3½-4 lbs.	C	Meats	HI 3-4 hrs. LO 6-8 hrs.	Place ribs in a single layer.
Pork Chops	4-8 lbs.	C	Meats	HI 3-4 hrs. LO 6-8 hrs.	Place chops in a single layer.
<b>Soup</b>					
Vegetable Beef Soup	4 quarts	C	Meats	HI 4-5 hrs. LO 8-10 hrs.	Make sure beef chunks are submerged.
Chili	4 quarts	C	Meats	HI 3-4 hrs. LO 6-8 hrs.	Submerge beans to prevent surface drying.

### Guideline Tips

- The slow cook program uses a complex series of temperature cycling to obtain the best results. For this reason, it is recommended that the slow cook program be allowed to run without cancelling or restarting. Restarting the slow cook feature while it is in progress may result in overcooked meat.
- For juicy and tender meat, choose cuts of meat such as chuck roast or a boneless blade roast. Leaner cuts of meat, such as top round, are drier and may need additional liquid.
- Use only glass and ceramic dishes. Metal pots and pans tend to transfer the heat into the foods too quickly.
- Match the quantity of food to the size pan. Fill the pan about 3/4 full for best results. Too large a pot allows the steam to escape, causing foods to dry out.
- Always cover the pot with a lid or aluminum foil.
- A wide range of recipes may be used in the slow cook feature. For best results some adjustments may need to be made. For smaller sized recipes, begin checking at minimum time. For large recipes or when doubling recipes, foods may be cooked for longer periods of time.
- When the slow cook feature completes, the oven will automatically switch to "warm" mode. If additional slow cook time is desired, this warm mode may be used to obtain the extra time.

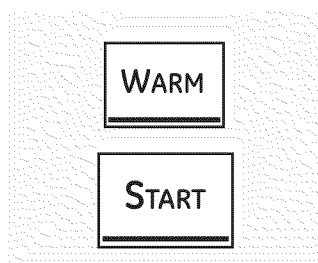

### How to Set the Oven For Warming

The **WARM** feature keeps cooked foods hot.

This feature is not designed to reheat cold food.

To use the **WARM** feature, touch the **WARM** pad and then the **START** pad.

**NOTE:** Plastic containers, lids or plastic wrap will melt if placed in the oven. Melted plastic may not be removable and is not covered under your warranty.

## **⚠ WARNING**

**FOOD POISON HAZARD:** Bacteria may grow in food at temperatures below 140°F.

- Always start with hot food. Do not use warm settings to heat cold food.
- Do not warm food for more than 2 hours.

Failure to follow these instructions may result in foodborne illness.

The warming drawer will keep hot, cooked foods at serving temperature. Always start with hot food. Do not use to heat cold food other than crisping crackers, chips or dry cereal.

### To Use the Warming Drawer

Touch the **WARMING DRAWER** pad. "SET WARMING DRAWER" and "1" are lit on the display and "Set" begins to blink. On the number pads, touch **1** for Low, **2** for Medium or **3** for High. The display "1" changes corresponding to the number pad selected. Press **START**.

To cancel, touch the **WARMING DRAWER** pad.

**NOTE:** Touching the **CLEAR/OFF** pad does not turn off the warming drawer.



### When Using the Warming Drawer

The warming drawer will keep hot, cooked foods warm. Always start with hot food. Do not use to heat cold food other than crisping crackers, chips or dry cereal.

**Do not line the warming drawer or pan with aluminum foil. Foil is an excellent heat insulator and will trap heat beneath it. This will upset the performance of the drawer and could damage the interior finish.**

Allow approximately 25 minutes for the warming drawer to preheat.

- Do not put liquid or water in the warming drawer.
- All foods placed in the warming drawer

should be covered with a lid or aluminum foil. When warming pastries or breads, the cover should be vented to allow moisture to escape.

- Food should be kept hot in its cooking container or transferred to a heat-safe serving dish.

**NOTE:** Plastic containers or plastic wrap will melt if in direct contact with the drawer, pan or a hot utensil. Melted plastic may not be removable and is not covered under your warranty.

- Remove serving spoons, etc., before placing containers in warming drawer.

### Temperature Selection Chart

To keep several different foods hot, set the control to the food needing the highest setting.

- The temperature, type and amount of food, and the time held will affect the quality of the food.
- Repeated opening of the drawer allows the hot air to escape and the food to cool.
- With large loads it may be necessary to use a higher warming drawer setting and cover some of the cooked food items.
- Do not use plastic containers or plastic wrap.

Food Type	Control Setting
Casserole	MED/2
Chili	HI/3
Pizza	MED/2
Potatoes, baked	HI/3
Tortilla Chips	LO/1
Waffles	LO/1

### To Crisp Stale Items

- Place food in low-sided dishes or pans.
- Preheat on **LO/1** setting.

- Check crispness after 45 minutes. Add time as needed.

### To Warm Serving Bowls and Plates

## **⚠ CAUTION**

Dishes will be hot. Use pot holders or mitts when removing hot dishes.

To warm serving bowls and plates, set the control on **LO/1**.

- Use only heat-safe dishes.
- If you want to heat fine china, please check with the manufacturer of the dishes for their maximum heat tolerance.
- You may warm empty serving dishes while preheating the drawer.

## Using the self-cleaning oven.

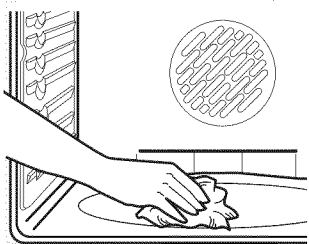

Wipe up heavy soil on the oven bottom.

### Before a Self-Clean Cycle

#### **⚠ WARNING**

**FIRE HAZARD:** Wipe grease and heavy soil from the oven bottom before self-cleaning. Failure to do so may result in an oven fire.

We recommend venting your kitchen with an open window or using a ventilation fan or hood during the first self-clean cycle.

Remove any broiler pan, broiler grid, probe, all cookware and any aluminum foil from the oven.

#### **NOTE:**

- If your oven is equipped with shiny, silver-colored oven racks, we recommend you remove them before you begin the self-clean cycle. They may remain in the oven during the self-clean cycle, but they will darken, lose their luster and become hard to slide.
- If your oven is equipped with gray porcelain-coated oven racks, they may be left in the oven during the self-clean cycle.

Soil on the front frame of the range and outside the gasket on the door will need to be cleaned by hand. Clean these areas with hot water, soap-filled steel-wool pads or cleansers such as Soft Scrub®. Rinse well with clean water and dry.

Do not clean the gasket. The fiberglass material of the oven door gasket cannot withstand abrasion. It is essential for the gasket to remain intact. If you notice it becoming worn or frayed, replace it.

Make sure the oven light bulb cover is in place and the oven light is off.

**IMPORTANT:** The health of some birds is extremely sensitive to the fumes given off during the self-cleaning cycle of any range. Move birds to another well-ventilated room.

#### **Double Oven and Canadian Models Only:**

The surface units are automatically disabled during the self-clean cycle. Make sure that all surface unit controls are turned off at all times during the self-clean cycle. Any surface unit that is set to an "on" position while the self-clean cycle is operating will automatically come on after the self-clean cycle is finished, and could result in an "on" unattended surface unit. Wait until the self-clean cycle is finished to set and use the surface units.

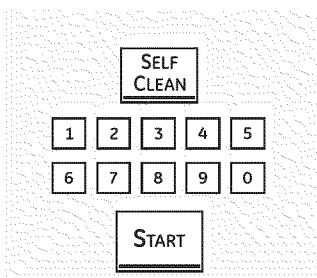

### How to Set the Oven for Self-Cleaning

The oven doors must be closed and all controls set correctly for the cycle to work properly.

- 1 Touch the **SELF CLEAN** pad.
- 2 If a time other than the default time is needed, use the number pads and enter the desired clean time.
- 3 Touch the **START** pad.

You can change the clean time to any time between 3 hours and 5 hours, depending on how dirty your oven is.

- 3 Touch the **START** pad.

The oven door locks automatically. The display will show the clean time remaining. It will not be possible to open the oven door until the temperature drops below the lock temperature and **LOCKED/DOOR**  goes off in the control display.

- The word **LOCKED/DOOR**  will flash and the word door will display if you set the clean cycle and forget to close the oven door.

- To stop a clean cycle, touch the **CLEAR/OFF** pad. When **LOCKED/DOOR**  goes off, indicating the oven has cooled below the locking temperature, you will be able to open the door.

#### **Double Ovens:**

- You can set a clean cycle in both ovens at the same time; however, they will not self-clean at the same time. The last oven set will automatically delay its start until the end of the first oven's clean cycle.
- When an oven is set to self-clean, both oven doors will lock and the cooktop controls will lock out. The ovens and cooktop cannot be used when an oven is set to self-clean.

The oven doors must be closed and all controls set correctly for the cycle to work properly.

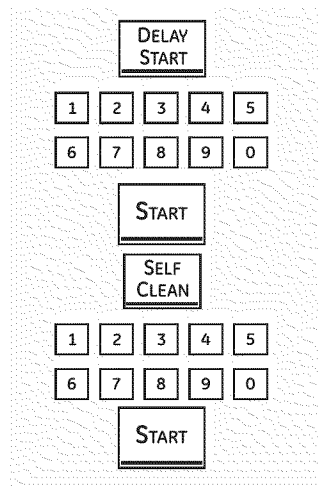

### How to Delay the Start of Self-Cleaning

- 1 Touch the **DELAY START** pad.
- 2 Using the number pads, enter the time of day you want the clean cycle to start.
- 3 Touch the **START** pad.
- 4 Touch the **SELF CLEAN** pad.
- 5 Use the number pads and enter the desired clean time.
- 6 Touch the **START** pad.

The oven door locks automatically. The display will show the start time. It will not be possible to open the oven door until the temperature drops below the lock temperature and **LOCKED/DOOR**  goes off in the control display.

You can change the clean time to any time between 3 hours and 5 hours, depending on how dirty your oven is.

### After a Self-Clean Cycle

You may notice some white ash in the oven. Wipe it up with a damp cloth after the oven cools.

*If white spots remain, remove them with a soap-filled steel wool pad and rinse thoroughly with a vinegar and water mixture.*

These deposits are usually a salt residue that cannot be removed by the clean cycle.

If the oven is not clean after one clean cycle, repeat the cycle.

- You cannot set the oven for cooking until the oven is cool enough for the door to unlock.
- While the oven is self-cleaning, you can touch **CLOCK** to display the time of day. To return to the clean countdown, touch **SELF CLEAN**.

#### Standard Racks

If they become hard to slide, wipe their side edges and the oven rack supports with cooking oil.

#### Extension Rack

If it becomes difficult to slide, see Extension Rack in the Care and cleaning section. Do not spray extension rack with cooking spray or other lubricant sprays.

If it becomes hard to remove or replace, wipe the oven rack supports with cooking oil. Do not wipe cooking oil on the slides.

**NOTE:** *After the first self-clean cycle, the gray stainless steel surfaces will change color on enameled extension racks. This is normal. It is not recommended to self-clean nickel extension racks as the whole rack will discolor because of the self-clean temperatures.*

## Using Steam Clean. (on some models)

### CAUTION

During the steam clean cycle, the oven bottom becomes hot enough to cause burns. Wait until the cycle is over (30 minutes) before wiping the inside surfaces of the oven. Failure to do so may result in burns.

The **Steam Clean** cycle makes it easier to clean light soiling off the standard-clean porcelain oven interior.

The range should be at room temperature before beginning the **Steam Clean** cycle. If the oven is too hot, "hot" will appear on the display and the cycle will not activate until the oven cools down.

The **Steam Clean** cycle performs best on new spills or soils. Burned-on food is more difficult to remove.

### To Begin Steam Clean Cycle:

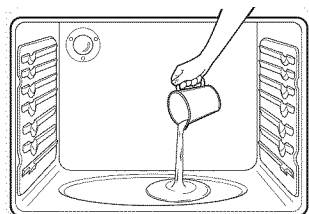

Pour 8 ounces of water onto the oven floor.

- 1 Remove racks and accessories from the oven cavity. Do not place cookware or other items in the oven during the **Steam Clean** cycle.
- 2 Pour 1 cup (8 oz.) room-temperature water onto the recessed area of the oven bottom. Do not add cleaning solutions or chemicals of any kind to the water. Only add water when using the **Steam Clean** cycle. Do not add water when using the **Self-Clean** cycle.
- 3 Close the door.

- 8 Remove soils using a scrub brush or nylon scouring pad. A soap-filled steel wool pad may be used only on the porcelain oven interior. The use of abrasive pads will scratch the door glass. Do not wipe soil or water onto the door gasket.
- 9 Remove any remaining water with a dry cloth or sponge.
- 10 Leave the door open to air dry.

### IMPORTANT NOTES:

- If a steam clean cycle is initiated without water, press the **Clear/Off** pad to end the cycle. Wait for the range to cool to room temperature before pouring water into the recessed area and initiating another steam cycle.
- Do not open the door during the **Steam Clean** cycle. An error beep will sound upon opening the door.
- Press **Clear/Off** pad at any time to end the cycle.
- If mineral deposits remain in the oven bottom after cleaning, use a cloth or sponge soaked in vinegar to remove them.
- Some water may drip from the bottom of the oven door. If this happens, wipe it up at the end of the cycle.
- The door gasket may be wet when the **Steam Clean** cycle finishes. This is normal. Do not clean the gasket.
- If soil still remains after cleaning the oven, see the *Care and cleaning of the range* section of the Owner's Manual for additional options.

- 4 Press the **Steam Clean** pad; then press **Start**.
- 5 The oven door locks automatically. A 30-minute cycle will begin to count down on the display. It will not be possible to open the oven door until the cycle ends or you press the **Clear/Off** pad and the door unlocks.
- 6 When the **Steam Clean** cycle is complete, the door will unlock, the oven control will beep, and the **Steam Clean** light will blink. Press the **Clear/Off** pad and open the door.
- 7 The oven bottom and remaining water will still be very warm at the end of the cycle. This is normal.

STEAM  
CLEAN

START

CLEAR  
OFF

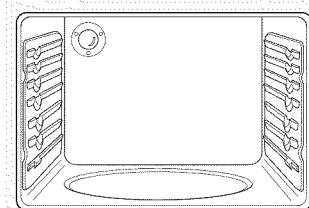



# Special features of your oven control.

Your new touch pad control has additional features that you may choose to use. The following are the features and how you may activate them.

The special feature modes can only be activated while the display is showing the time of day. They remain in the control's memory until the steps are repeated.

To enter a special feature for either oven, you must first touch the upper oven **BROIL HI/LO** and **BAKE** pads at the same time. The lower oven **BROIL HI/LO** and **BAKE** pads will not activate special features.

When the display shows your choice, touch the **START** pad. The special features will remain in memory after a power failure, except for the Sabbath feature, which will have to be reset.

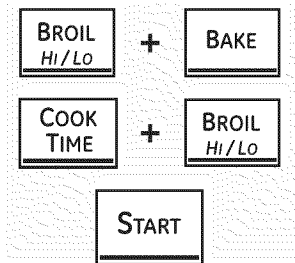

## Fahrenheit or Celsius Temperature Selection

Your oven control is set to use the Fahrenheit temperature selections, but you may change this to use the Celsius selections.

- 1 Touch the upper oven **BROIL HI/LO** and **BAKE** pads at the same time until the display shows **SF**.
- 2 Touch the **COOK TIME** and **BROIL HI/LO** pads at the same time. The display will show **F** (Fahrenheit).

- 3 Touch the **COOK TIME** and **BROIL HI/LO** pads again at the same time. The display will show **C** (Celsius).
- 4 Touch the **START** pad.

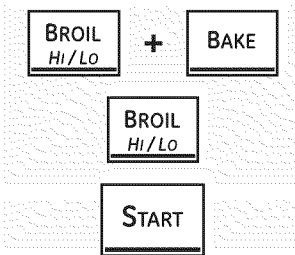

## Tones at the End of a Timed Cycle

At the end of a timed cycle, 3 short beeps will sound followed by one beep every 6 seconds until the **CLEAR/OFF** pad is touched. This continual 6-second beep may be cancelled.

To cancel the 6-second beep:

- 1 Touch the upper oven **BROIL HI/LO** and **BAKE** pads at the same time until the display shows **SF**.
- 2 Touch the **BROIL** pad. The display shows **CON BEEP** (continuous beep). Touch the **BROIL** pad again. The display shows **BEEP**. (This cancels the one beep every 6 seconds.)
- 3 Touch the **START** pad.

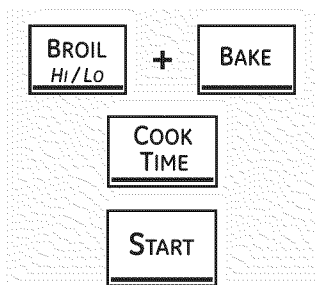

## Tone Volume

This feature allows you to adjust the tone volumes to a more acceptable volume. There are three possible volume levels.

- 1 Touch the upper oven **BROIL HI/LO** and **BAKE** pads at the same time until the display shows **SF**.
- 2 Touch the **COOK TIME** pad. The display will show **STD BEEP**. This is the middle volume level.

Touch the **COOK TIME** pad again. This changes the volume level each time the pad is touched, and a tone will sound to provide an indication of the volume level. Choose the desired sound level (**LO BEEP**, **STD BEEP**, **HI BEEP**, or **OFF**).

- 3 Touch the **START** pad to activate the level shown.

## Special features of your oven control.

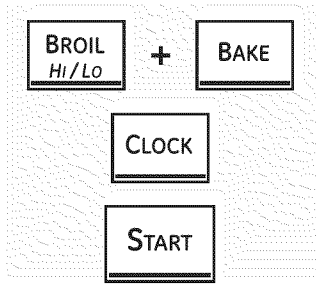

### 12-Hour, 24-Hour or Clock Blackout

Your control is set to use a 12-hour clock.

If you would prefer to have a 24-hour military time clock or black out the clock display, follow the steps below.

- 1 Touch the upper oven **BROIL HI/LO** and **BAKE** pads at the same time until the display shows **SF**.
- 2 Touch the **CLOCK** pad once. The display will show **12 h**. If this is the choice you want, touch the **START** pad.

Touch the **CLOCK** pad again to change to the 24-hour military time clock. The display will show **24 h**. If this is the choice you want, touch the **START** pad.

Touch the **CLOCK** pad again to black out the clock display. The display will show **OFF**. If this is the choice you want, touch the **START** pad.

**NOTE:** If the clock is in the black-out mode, you will not be able to use the **Delay Start** function.

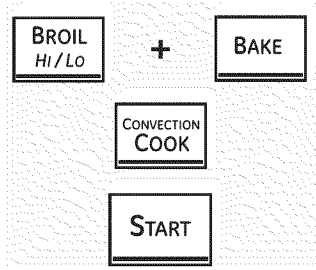

### Auto Recipe™ Conversion (on some models)

When using convection bake, the Auto Recipe™ Conversion feature can automatically convert entered regular baking temperatures to convection baking temperatures. The display will not show the converted temperature. It will always show the temperature entered.

To activate or deactivate the feature:

- 1 Touch the upper oven **BAKE** and **BROIL HI/LO** pads at the same time until the display shows **SF**.

- 2 Touch the **CONVECTION COOK** or **CONVECTION BAKE** pad until the display shows **CON ON** (Conversion On) or **CON OFF** (Conversion Off) as desired.
- 3 Touch the **START** pad.

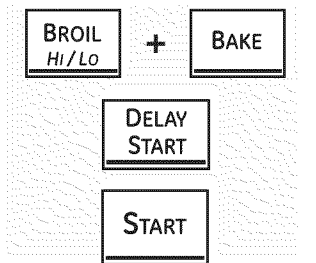

### 12-Hour Shutdown

With this feature, should you forget and leave the oven on, the control will automatically turn off the oven after 12 hours during baking functions or after 3 hours during a broil function.

If you wish to turn **OFF** this feature, follow the steps below.

- 1 Touch the upper oven **BROIL HI/LO** and **BAKE** pads at the same time until the display shows **SF**.

- 2 Touch the **DELAY START** pad until no shdn (no shut-off) appears in the display.

- 3 Touch the **START** pad to activate the no shut-off and leave the control set in this special features mode.

# Using the Sabbath feature. (upper and lower ovens)

(Designed for use on the Jewish Sabbath and Holidays) (on some models)

GEAppliances.com

The Sabbath feature can be used for baking/roasting only. It cannot be used for convection, broiling, self-cleaning or Delay Start cooking.

**NOTE:** The oven light comes on automatically (on some models) when the door is opened and goes off when the door is closed. The bulb may be removed. See the Oven Light Replacement section. On models with a light switch on the control panel, the oven light may be turned on and left on.

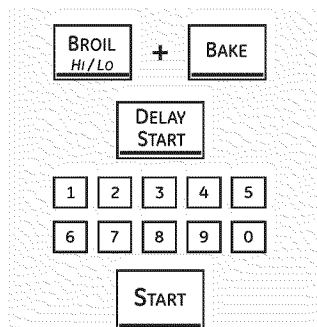

When the display shows  $\supset$ , the oven is set in Sabbath. When the display shows  $\supset\subset$ , the oven is baking/roasting.

## How to Set for Regular Baking/Roasting

Make sure the clock shows the correct time of day and the oven is off.

- 1 Touch and hold both the upper oven **BROIL HI/LO** and **BAKE** pads, at the same time, until the display shows **SF**.

**NOTE:** If bake or broil appears in the display, the **BROIL HI/LO** and **BAKE** pads were not touched at the same time. Touch the **CLEAR/OFF** pad and begin again.

- 2 Tap the **DELAY START** pad until **Sab bATH** appears in the display.

- 3 Touch the **START** pad and  $\supset$  will appear in the display. The oven is now in Sabbath mode.

- 4 Touch the **BAKE** pad. No signal will be given.

- 5 Using the number pads, enter the desired temperature between 170°F and 550°F. No signal or temperature will be given. There is no default temperature.

- 6 Touch the **START** pad on the corresponding oven.

- 7 After a random delay period of approximately 30 seconds to 1 minute,  $\supset\subset$  will appear in the display indicating that the oven is baking/roasting. If  $\supset\subset$  doesn't appear in the display, start again at Step 4.

To adjust the oven temperature, touch the **BAKE** pad, enter the new temperature using the number pads and touch the **START** pad.

**NOTE:** The **CLEAR/OFF** and **COOK TIME** pads are active during the Sabbath feature.

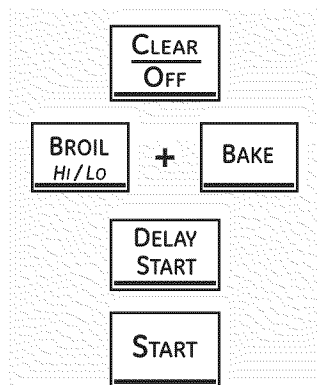

## How to Exit the Sabbath Feature

- 1 Touch the **CLEAR/OFF** pad.

- 2 If the oven is cooking, wait for a random delay period of approximately 30 seconds to 1 minute, until only  $\supset$  is in the display.

- 3 Touch and hold both the **BROIL HI/LO** and **BAKE** pads, at the same time, until the display shows **SF**.

- 4 Tap the **DELAY START** pad until **12 shdn** or **no shdn** appears in the display.

- 5 Choose **12 shdn**, indicating that the oven will automatically turn off after **12 hours** or **no shdn**, indicating that the oven will not automatically turn off after 12 hours.

- 6 Press **START** when the option that you want is in the display (12 shdn or no shdn).

**NOTE:** If a power outage occurred while the oven was in Sabbath, the oven will automatically turn off and stay off even when the power returns. The oven control must be reset. Some models will resume Sabbath mode; however, opening the door will activate the oven light.

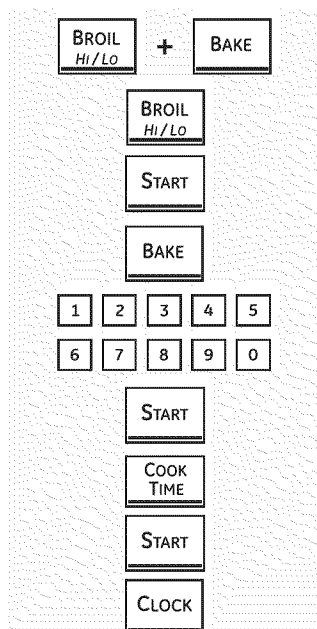

## How to Set for Timed Baking

**NOTE:** This procedure must take place **BEFORE** the Sabbath begins to be able to use the Timed Bake feature during the Sabbath (the unit should **NOT** be put into Sabbath mode during a Time Bake).

Make sure the clock shows the correct time of day and the oven is off.

- 1 Touch and hold **both** the upper oven **BROIL HI/LO** and **BAKE** pads, **at the same time**, until the display shows **SF**.

**NOTE:** If bake or broil appears in the display, the **BROIL HI/LO** and **BAKE** pads were not touched at the same time. Touch the **CLEAR/OFF** pad and begin again.

- 2 Press the **BROIL HI/LO** pad to change the beeper setting to **bEEP** (the default setting is Continuous Beep, which shows in the display as **Con bEEP**).

- 3 Press the **START** pad to save the changes.

- 4 Press the **BAKE** pad.

- 5 Using the number pads, enter the desired temperature.

- 6 Press the **START** pad on the corresponding oven.

- 7 Press **COOK TIME FOR** for the corresponding oven.

- 8 Press the number pads to set the desired length of cooking time between 1 minute and 9 hours and 59 minutes.

- 9 Press the **START** pad.

- 10 Press the **CLOCK** pad to display the current time of day. This is to display the time of day instead of the countdown cook timer. The oven will operate at the set temperature for the set amount of time, and then it will shut off. At the time the oven shuts off, the beeper will beep 3 times.

## Care and cleaning of the range.

---

Be sure all controls are off and all surfaces are cool before cleaning any part of the range.



### **⚠ WARNING**

If your range is removed for cleaning, servicing or any reason, be sure the anti-tip device is reengaged properly when the range is replaced. Failure to take this precaution could result in tipping of the range and can result in death or serious burns to children or adults.

---

### **How to Remove Protective Shipping Film and Packaging Tape**

Carefully grasp a corner of the protective shipping film with your fingers and slowly peel it from the appliance surface. Do not use any sharp items to remove the film. Remove all of the film before using the appliance for the first time.

To ensure no damage is done to the finish of the product, the safest way to remove the adhesive from packaging tape on new appliances is an application of a household liquid dishwashing detergent. Apply with a soft cloth and allow to soak.

**NOTE:** The adhesive must be removed from all parts. It cannot be removed if it is baked on.

---

### **Control Knobs**

If desired, the touch pads may be deactivated before cleaning using the Range Lockout or Control Lockout feature.

Replace the knobs, in the **OFF** position to ensure proper placement.

The knobs can be cleaned in a dishwasher or they may also be washed with soap and water. Make sure the inside of the knobs are dry before replacing.

---

### **Control Panel**

If desired, the touch pads may be deactivated before cleaning.

Clean up splatters with a damp cloth.

See *How to Lock Out the Controls* in the *Using the clock, kitchen timer and control lockout* section in this manual.

You may also use a glass cleaner.

Remove heavier soil with warm, soapy water. Do not use abrasives of any kind.

Reactivate the touch pads after cleaning.

---

### **Painted Surfaces**

Painted surfaces include the sides of the range and the door, top of control panel and the drawer front. Clean these with soap and water or a vinegar and water solution.

Do not use commercial oven cleaners, cleaning powders, steel wool or harsh abrasives on any painted surface.

---

### **Stainless Steel Surfaces** (on some models)

**Do not use a steel wool pad; it will scratch the surface.**

To inquire about purchasing stainless steel appliance cleaner or polish or to find the location of a dealer nearest you, please call our toll-free number:

To clean the stainless steel surface, use warm, sudsy water or a stainless steel cleaner or polish. Always wipe the surface in the direction of the grain. Follow the cleaner instructions for cleaning the stainless steel surface.

**National Parts Center**      **1.800.626.2002**  
**GEAppliances.com**

---

### **Porcelain Enamel Cooktop** (on some models)

The porcelain enamel finish is sturdy but breakable if misused. This finish is acid-resistant. However, any acidic foods spilled (such as fruit juices, tomato or vinegar) should not be permitted to remain on the finish.

away. When the surface has cooled, wash with soap and water. Rinse well.

If acids spill on the cooktop while it is hot, use a dry paper towel or cloth to wipe it up right

For other spills such as fat splatterings, wash with soap and water or cleansing powders after the surface has cooled. Rinse well. Polish with a dry cloth.

**⚠ WARNING**

**SHOCK OR BURN HAZARD:** Before replacing oven light bulb, disconnect the electrical power to the range at the main fuse or circuit breaker panel. Failure to do so may result in electric shock or burn.

**⚠ CAUTION**

**BURN HAZARD:** The glass cover and bulb should be removed when cool. Touching hot glass with bare hands or a damp cloth can cause burns.

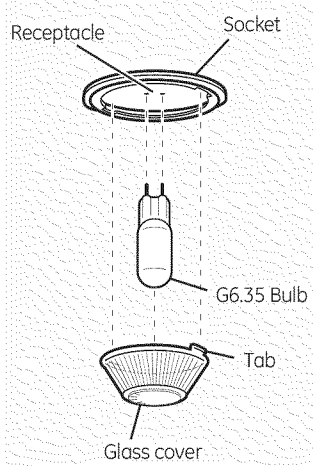

(on some models)

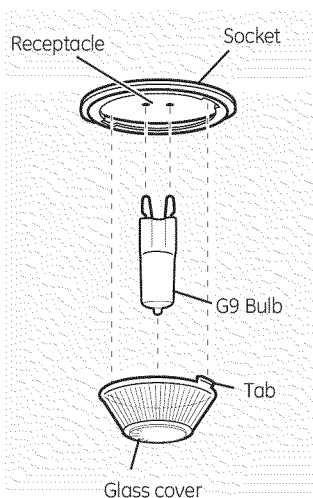

(on some models)

**Oven Light Replacement** (on some models)

**To remove:**

- 1 Turn the glass cover counterclockwise 1/4 turn until the tabs of the glass cover clear the grooves of the socket. Wearing latex gloves may offer a better grip.
- 2 Using gloves or a dry cloth, remove the bulb by pulling it straight out.

**To replace:**

- 1 Use a new 120/130-volt halogen bulb, not to exceed 50 watts. Replace the bulb with the same type of bulb that was removed. Your model will have one of the two types shown on the left. To determine the correct replacement bulb, check the bulb terminals. Bulbs with 2 straight pin terminals are G6.35 bulbs. Bulbs with 2 looped terminals are G9 bulbs. (Do not interchange.) Be sure the replacement bulb is rated 120 volts or 130 volts (NOT 12 volts).
- 2 Using gloves or a dry cloth, remove the bulb from its packaging. Do not touch the bulb with bare fingers. Oil from skin will damage the bulb and shorten its life.

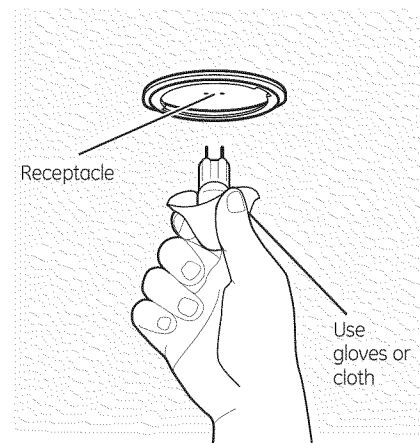

- 3 Push the bulb straight into the receptacle all the way.
  - 4 Place the tabs of the glass cover into the grooves of the socket. Turn the glass cover clockwise 1/4 turn.
- For improved lighting inside the oven, clean the glass cover frequently using a wet cloth. This should be done when the oven is completely cool.
- 5 Reconnect electrical power to the oven.

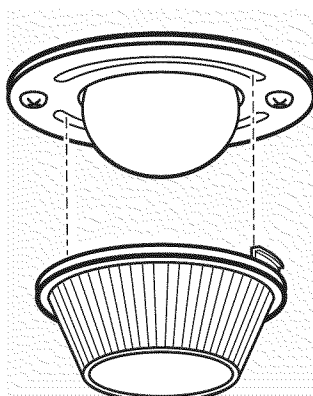

**Oven Light Replacement** (on some models)

**To remove:**

- 1 Turn the glass cover counterclockwise 1/4 turn until the tabs of the glass cover clear the grooves of the socket. Wearing latex gloves may offer a better grip.
- 2 Remove the bulb by turning it counterclockwise.

**To replace:**

- 1 Replace bulb with a new 40-watt appliance bulb. Insert the bulb and turn it clockwise until it is tight.

- 2 Place the tabs of the glass cover into the grooves of the socket. Turn the glass cover clockwise 1/4 turn.
- For improved lighting inside the oven, clean the glass cover frequently using a wet cloth. This should be done when the oven is completely cool.
- 3 Reconnect electrical power to the oven.

# Care and cleaning of the range.

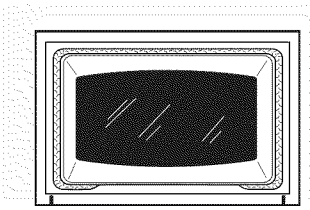

The gasket is designed with a gap at the bottom to allow for proper air circulation.

Do not rub or clean the door gasket—it has an extremely low resistance to abrasion.

If you notice the gasket becoming worn, frayed or damaged in any way or if it has become displaced on the door, you should have it replaced.

## Cleaning the Oven Door

### To clean the inside of the door:

- Because the area inside the gasket is cleaned during the self-clean cycle, you do not need to clean this by hand.
- The area outside the gasket and the door liner can be cleaned with a soap-filled or plastic scouring pad, hot water and detergent. Rinse well with a vinegar and water solution.

### To clean the outside of the door:

- Use soap and water to thoroughly clean the top, sides and front of the oven door. Rinse well. You may also use a glass cleaner to clean the glass on the outside of the door. Do not let water drip into the vent openings.

- If any stain on the door vent trim is persistent, use a soft abrasive cleaner and a sponge-scrubber for best results.
- Spillage of marinades, fruit juices, tomato sauces and basting materials containing acids may cause discoloration and should be wiped up immediately. When surface is cool, clean and rinse.
- Do not use oven cleaners, cleaning powders or harsh abrasives on the outside of the door.

## Lift-Off Oven Door (on some models)

The door is very heavy. Be careful when removing and lifting the door.

Do not lift the door by the handle.

### To remove the door:

- 1 Fully open the door.
- 2 Pull the hinge locks down toward the door frame, to the unlocked position. A tool, such as a small flat-blade screwdriver, may be required.
- 3 Firmly grasp both sides of the door at the top.
- 4 Close door to the door removal position, which is halfway between the broil stop position and fully closed.
- 5 Lift door up and out until the hinge arm is clear of the slot.

### To replace the door:

- 1 Firmly grasp both sides of the door at the top.

- 2 With the door at the same angle as the removal position, seat the indentation of the hinge arm into the bottom edge of the hinge slot. The notch in the hinge arm must be fully seated into the bottom of the slot.
- 3 Fully open the door. If the door will not fully open, the indentation is not seated correctly in the bottom edge of the slot.
- 4 Push the hinge locks up against the front frame of the oven cavity to the locked position.

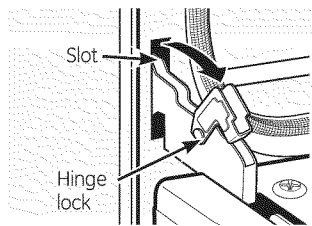

Pull hinge locks down to unlock.

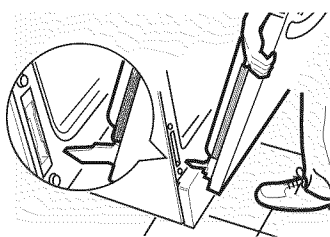

Removal position

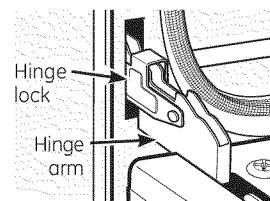
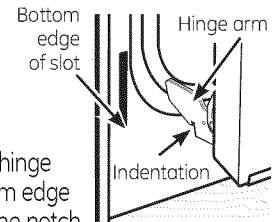

Push hinge locks up to lock.

- 5 Close the oven door.

### Lift-Off Upper Oven Door (on some models)

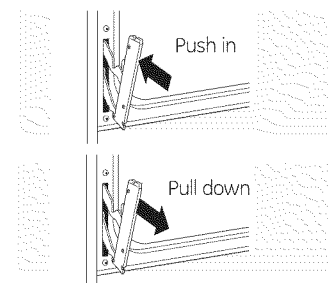
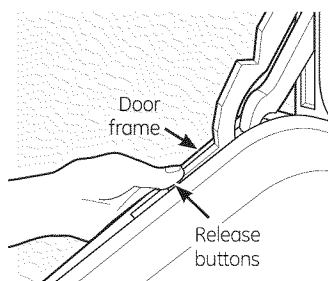
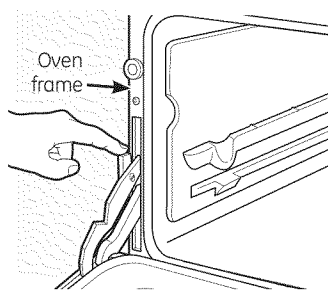

#### To remove the door:

- 1 Fully open the door.
- 2 Lift up on the hinge lock toward the oven frame until they stop.
- 3 Close the door to 45 degrees (you will feel the door stop). The hinge lock will contact the oven frame.
- 4 On both sides of the door, press down on the release buttons on each hinge.
- 5 Lift door up until it is clear of the hinge.
- 6 Pull on hinge arms slightly to relieve pressure on the locking tabs.
- 7 Push the hinge locks down onto the hinge.
- 8 Push the hinges in toward the unit so they are closed.

#### To replace the door:

- 1 Pull the hinges down away from the oven frame to the fully open position.
- 2 Lift up on the hinge locks toward the oven frame until they stop.
- 3 The hinges will release to the 45-degree position. The hinge locks will contact the oven frame.
- 4 Slide the door back onto the hinges. Make sure the buttons pop back out.
- 5 Fully open the door.
- 6 Push the hinge locks down onto the hinge.
- 7 Close the oven door.

# Care and cleaning of the range.

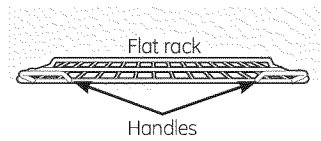

For double ovens, use the rack with the two front handles in the upper oven.

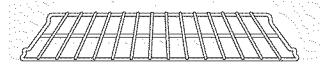

For double ovens, use the rack without the two front handles in the lower oven.

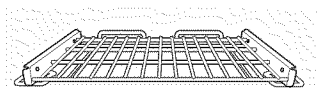

## Oven Racks

All oven racks may be cleaned by hand with an abrasive cleaner or steel wool. After cleaning, rinse the racks with clean water and dry with a clean cloth. Gray porcelain-coated oven racks may remain in the oven during the self-cleaning cycle without being damaged. The nickel-plated oven racks may remain in the oven during the self-cleaning cycle, but they will lose their luster

and become hard to slide. It will be necessary to grease all oven rack side edges with a light coating of vegetable oil after cleaning them by hand or in the oven. This will help maintain the ease of sliding the racks in and out of the oven.

## Extension Rack (on some models)

Extension racks may be cleaned by hand with an abrasive cleaner or steel wool. During cleaning, be careful not to allow water or cleaner to enter the extension slides on the sides of the rack.

**NOTE:** Do not clean in a dishwasher.

If the rack becomes hard to remove or replace, lightly wipe the oven rack supports with cooking oil. Do not wipe cooking oil on the slides.

If the rack becomes difficult to slide or if the paddle is difficult to actuate, the rack may need to be lubricated using the Graphite Lubrication shipped with your oven. To order additional Graphite Lubrication, call our National Parts Center at 800.626.2002 and reference WB02T10303.

## To lubricate the slides:

**NOTE:** Do not spray extension rack with cooking spray or other lubricant sprays.

- 1 Remove the rack from the oven. See Extension Rack in the Using the oven section.
- 2 Fully extend the rack on a table or countertop. Newspaper may be placed underneath the rack for easy cleanup.
- 3 If there is debris in the slide tracks, wipe it away using a paper towel.  
**NOTE:** Any graphite lubricant wiped away must be replaced - see steps 4 through 7.
- 4 Shake the graphite lubricant before opening it. Starting with the left slide mechanism of the rack, place four (4) small drops of lubricant on the two (2) bottom tracks of the slide close to the bearing carriers.
- 5 Repeat for the right slide mechanism of the rack.

- 6 Open and close the rack several times to distribute the lubricant.
- 7 Replace the cap on the lubricant and shake it again. Turn the rack over and repeat steps 3, 4, 5 and 6.
- 8 Close the rack, turn rack right-side-up and place in the oven. See Extension Rack in the Using the oven section.

## To lubricate the paddle:

Shake lubricant and apply to the moving parts of the paddle mechanisms as shown.

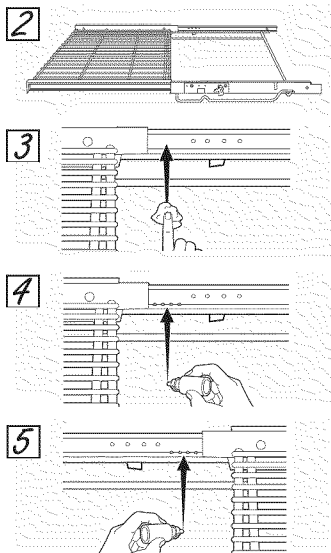
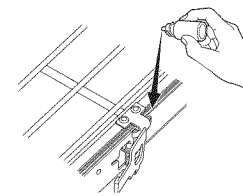



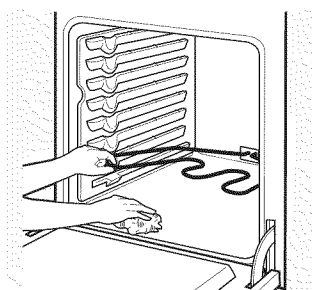

### Oven Heating Elements

Do not clean the bake element or the broil element. Any soil will burn off when the elements are heated.

To clean the oven floor, gently lift the bake element. On some models, the bake element is not exposed and is under the oven floor. Clean with warm, soapy water.

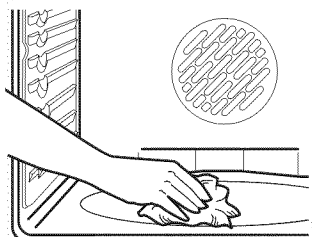

Wipe up heavy soil on the oven bottom.

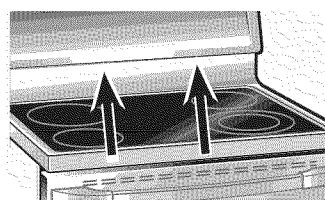

### Oven Vent on Radiant Glass Cooktops

All models have an oven vent located behind the right rear surface unit. On double ovens, there is an additional oven vent for the upper oven behind the left rear surface unit.

It is normal for steam to come out of the vent, and moisture may collect underneath it when the oven is in use.

This area could become hot during oven use.

The vent is important for proper air circulation. Never block this vent.

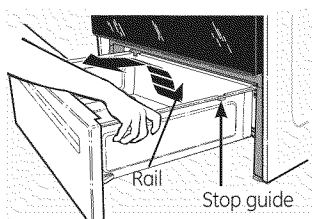

### Storage Drawer Removal (on some models)

#### To remove the drawer:

- 1 Pull the drawer out until it stops.
- 2 Lift the front of the drawer until the stops clear the guides.
- 3 Remove the drawer.

#### To replace the drawer:

- 1 Place the drawer rails on the guides.
- 2 Push the drawer back until it stops.
- 3 Lift the front of the drawer and push back until the stops clear the guides.
- 4 Lower the front of the drawer and push back until it closes.

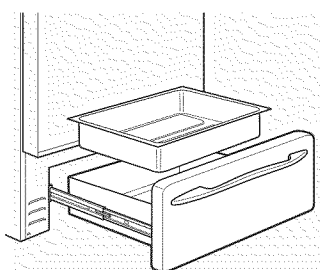

### Removable Warming Drawer Pan (on some models)

**NOTE:** For models with an electric warming drawer before performing any adjustments, cleaning or service, disconnect the range electrical power supply at the household distribution panel by removing the fuse or switching off the circuit breaker. Make sure the drawer heating element is cool.

- Never place, use or self-clean the drawer pan in the upper oven.
- Warming drawer has a removable pan for easy cleaning. Clean with hot, soapy water and a sponge or dish towel. Dry with a clean cloth. Replace the pan in the warming drawer.

**NOTE:** Allow warming drawer to cool before removing pan.

**NOTE:** Wipe spills promptly after each use.

## Cleaning the glass cooktop. *(on some models)*



Clean your cooktop after each spill. Use CERAMA BRYTE® Ceramic Cooktop Cleaner.

### Normal Daily Use Cleaning

ONLY use CERAMA BRYTE® Ceramic Cooktop Cleaner on the glass cooktop. Other creams may not be as effective.

To maintain and protect the surface of your glass cooktop, follow these steps:

- 1 Before using the cooktop for the first time, clean it with CERAMA BRYTE® Ceramic Cooktop Cleaner. This helps protect the top and makes cleanup easier.
- 2 Daily use of CERAMA BRYTE® Ceramic Cooktop Cleaner will help keep the cooktop looking new.

- 3 Shake the cleaning cream well. Apply a few drops of CERAMA BRYTE® Ceramic Cooktop Cleaner directly to the cooktop.
- 4 Use a paper towel or CERAMA BRYTE® Cleaning Pad for Ceramic Cooktops to clean the entire cooktop surface.
- 5 Use a dry cloth or paper towel to remove all cleaning residue. No need to rinse.

**NOTE:** It is very important that you **DO NOT** heat the cooktop until it has been cleaned thoroughly.

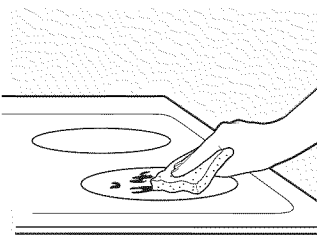

Use a CERAMA BRYTE® Cleaning Pad for Ceramic Cooktops.

### Burned-On Residue

**NOTE:** DAMAGE to your glass surface may occur if you use scrub pads other than those recommended.

- 1 Allow the cooktop to cool.
- 2 Spread a few drops of CERAMA BRYTE® Ceramic Cooktop Cleaner on the entire burned residue area.
- 3 Using the included CERAMA BRYTE® Cleaning Pad for Ceramic Cooktops, rub the residue area, applying pressure as needed.

- 4 If any residue remains, repeat the steps listed above as needed.
- 5 For additional protection, after all residue has been removed, polish the entire surface with CERAMA BRYTE® Ceramic Cooktop Cleaner and a paper towel.

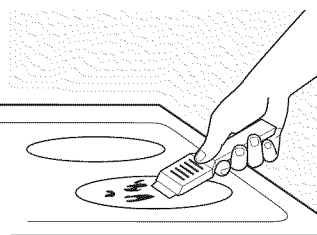

The CERAMA BRYTE® Ceramic Cooktop Scraper and all recommended supplies are available through our Parts Center. See instructions under "To Order Parts" section on next page.

**NOTE:** Do not use a dull or nicked blade.

### Heavy, Burned-On Residue

- 1 Allow the cooktop to cool.
- 2 Use a single-edge razor blade scraper at approximately a 45° angle against the glass surface and scrape the soil. It will be necessary to apply pressure to the razor scraper in order to remove the residue.
- 3 After scraping with the razor scraper, spread a few drops of CERAMA BRYTE® Ceramic Cooktop Cleaner on the entire burned residue area. Use the CERAMA BRYTE® Cleaning Pad to remove any remaining residue.

- 4 For additional protection, after all residue has been removed, polish the entire surface with CERAMA BRYTE® Ceramic Cooktop Cleaner and a paper towel.

### Metal Marks and Scratches

- 1 Be careful not to slide pots and pans across your cooktop. It will leave metal markings on the cooktop surface.  
These marks are removable using the CERAMA BRYTE® Ceramic Cooktop Cleaner with the CERAMA BRYTE® Cleaning Pad for Ceramic Cooktops.
- 2 If pots with a thin overlay of aluminum or copper are allowed to boil dry, the overlay may leave black discoloration on the cooktop.

This should be removed immediately before heating again or the discoloration may be permanent.

**NOTE:** Carefully check the bottom of pans for roughness that would scratch the cooktop.

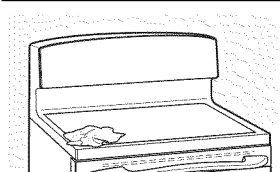

### Cooktop Seal

To clean the cooktop seal around the edges of the glass, lay a wet cloth on it for a few minutes, then wipe clean with nonabrasive cleaners.

## Glass surface—potential for permanent damage.

Sugary spillovers (such as jellies, fudge, candy, syrups) or melted plastics can cause pitting of the surface of your cooktop (not covered by the warranty) unless the spill is removed while still hot. Special care should be taken when removing hot substances.

Be sure to use a new, sharp razor scraper.

Do not use a dull or nicked blade.

### Damage from Sugary Spills and Melted Plastic

- 1 Turn off all surface units. Remove hot pans.
- 2 Wearing an oven mitt:
  - a. Use a single-edge razor blade scraper (CERAMA BRYTE® Ceramic Cooktop Scraper) to move the spill to a cool area on the cooktop.
  - b. Remove the spill with paper towels.
- 3 Any remaining spillover should be left until the surface of the cooktop has cooled.
- 4 Don't use the surface units again until all of the residue has been completely removed.

**NOTE:** If pitting or indentation in the glass surface has already occurred, the cooktop glass will have to be replaced. In this case, service will be necessary.



### To Order Parts

To order CERAMA BRYTE® Ceramic Cooktop Cleaner and the cooktop scraper, please call our toll-free number:

**National Parts Center 800.626.2002**

**CERAMA BRYTE® Ceramic Cooktop Cleaner** .....#WX10X300

**CERAMA BRYTE® Ceramic Cooktop Scraper** .....#WX10X0302

**Kit** .....#WB64X5027  
(Kit includes cream and cooktop scraper)

**CERAMA BRYTE® Cleaning Pads for Ceramic Cooktops** .....#WX10X350

## Before You Call For Service...



*Troubleshooting Tips*  
Save time and money! Review the charts on the following pages first and you may not need to call for service.

<b>Problem</b>	<b>Possible Causes</b>	<b>What To Do</b>
<b>Surface units will not maintain a rolling boil or cooking is not fast enough</b>	Improper cookware being used.	<ul style="list-style-type: none"> <li>Use pans which are flat and match the diameter of the surface unit selected.</li> </ul>
	In some areas, the power (voltage) may be low.	<ul style="list-style-type: none"> <li>Cover pan with a lid until desired heat is obtained.</li> </ul>
<b>Surface units do not work properly</b>	A fuse in your home may be blown or the circuit breaker tripped.	<ul style="list-style-type: none"> <li>Replace the fuse or reset the circuit breaker.</li> </ul>
	Cooktop controls improperly set.	<ul style="list-style-type: none"> <li>Check to see the correct control is set for the surface unit you are using.</li> </ul>
<b>Surface unit stops glowing when turned to a lower setting</b>	This is normal. The unit is still on and hot.	
<b>Scratches (may appear as cracks) on cooktop glass surface</b>	Incorrect cleaning methods being used.	<ul style="list-style-type: none"> <li>Scratches are not removable. Tiny scratches will become less visible in time as a result of cleaning.</li> </ul>
	Cookware with rough bottoms being used or coarse particles (salt or sand) were between the cookware and the surface of the cooktop.	<ul style="list-style-type: none"> <li>To avoid scratches, use the recommended cleaning procedures. Make sure bottoms of cookware are clean before use, and use cookware with smooth bottoms.</li> </ul>
	Cookware has been slid across the cooktop surface.	
<b>Areas of discoloration on the cooktop</b>	Food spillovers not cleaned before next use.	<ul style="list-style-type: none"> <li>See the Cleaning the glass cooktop section.</li> </ul>
	Hot surface on a model with a light-colored cooktop.	<ul style="list-style-type: none"> <li>This is normal. The surface may appear discolored when it is hot. This is temporary and will disappear as the glass cools.</li> </ul>
<b>Plastic melted to the surface</b>	Hot cooktop came into contact with plastic placed on the hot cooktop.	<ul style="list-style-type: none"> <li>See the <i>Glass surface—potential for permanent damage</i> section in the <i>Cleaning the glass cooktop</i> section.</li> </ul>
<b>Pitting (or indentation) of the cooktop</b>	Hot sugar mixture spilled on the cooktop.	<ul style="list-style-type: none"> <li>Call a qualified technician for replacement.</li> </ul>
<b>Frequent cycling off and on of surface units</b>	Improper cookware being used.	<ul style="list-style-type: none"> <li>Use only flat cookware to minimize cycling.</li> </ul>
<b>Oven light does not work</b>	Light bulb is loose.	<ul style="list-style-type: none"> <li>Tighten or replace the bulb.</li> </ul>
<b>Oven will not work</b>	Plug on range is not completely inserted in the electrical outlet.	<ul style="list-style-type: none"> <li>Make sure electrical plug is plugged into a live, properly grounded outlet.</li> </ul>
	A fuse in your home may be blown or the circuit breaker tripped.	<ul style="list-style-type: none"> <li>Replace the fuse or reset the circuit breaker.</li> </ul>
	Oven controls improperly set.	<ul style="list-style-type: none"> <li>See the <i>Using the oven</i> section.</li> </ul>
	Oven too hot.	<ul style="list-style-type: none"> <li>Allow the oven to cool to below locking temperature.</li> </ul>

<b>Problem</b>	<b>Possible Causes</b>	<b>What To Do</b>
<b>Food does not bake or roast properly</b>	Oven controls improperly set.	<ul style="list-style-type: none"> <li>• See the <i>Using the oven</i> section.</li> </ul>
	Rack position is incorrect or the rack is not level.	<ul style="list-style-type: none"> <li>• See the <i>Using the oven</i> section.</li> </ul>
	Incorrect cookware or cookware of improper size being used.	<ul style="list-style-type: none"> <li>• See the <i>Using the oven</i> section.</li> </ul>
	Oven thermostat needs adjustment.	<ul style="list-style-type: none"> <li>• See the <i>Adjust the oven thermostat—Do it yourself!</i> section.</li> </ul>
<b>Food does not broil properly</b>	Oven controls improperly set.	<ul style="list-style-type: none"> <li>• Make sure you touch the <b>BROIL HI/LO</b> pad.</li> </ul>
	Improper rack position being used.	<ul style="list-style-type: none"> <li>• See the <i>Broiling Guide</i>.</li> </ul>
	Cookware not suited for broiling.	<ul style="list-style-type: none"> <li>• For best results, use a pan designed for broiling.</li> </ul>
	The probe is plugged into the outlet in the oven. (on some models)	<ul style="list-style-type: none"> <li>• Unplug and remove the probe from the oven.</li> </ul>
	In some areas the power (voltage) may be low.	<ul style="list-style-type: none"> <li>• Preheat the broil element for 10 minutes.</li> <li>• Broil for the longest period of time recommended in the <i>Broiling Guide</i>.</li> </ul>
<b>Oven temperature too hot or too cold</b>	Oven thermostat needs adjustment.	<ul style="list-style-type: none"> <li>• See the <i>Adjust the oven thermostat—Do it yourself!</i> section.</li> </ul>
<b>Storage drawer is crooked</b>	Rear drawer support is on top of the guide rail.	<ul style="list-style-type: none"> <li>• Reposition the drawer. See the <i>Storage Drawer Removal instructions</i> in the <i>Care and cleaning of the range</i> section.</li> <li>• Check to make sure drawer is properly seated if removed.</li> </ul>
<b>Storage drawer won't close</b>	Power cord may be obstructing drawer in the lower back of the range.	<ul style="list-style-type: none"> <li>• Reposition the drawer and power cord. See the <i>Storage Drawer Removal instructions</i> in the <i>Care and cleaning of the range</i> section.</li> </ul>
	Rear drawer support is on top of the guide rail.	<ul style="list-style-type: none"> <li>• Reposition the drawer. See the <i>Storage Drawer Removal instructions</i> in the <i>Care and cleaning of the range</i> section.</li> </ul>
<b>Oven door is crooked</b>	The door is out of position.	<ul style="list-style-type: none"> <li>• Because the oven door is removable, it sometimes gets out of position during installation.</li> <li>• To straighten the door, push down on the high corner.</li> </ul>

## Before You Call For Service...



### Troubleshooting Tips

Problem	Possible Causes	What To Do
Clock and timer do not work	Plug on range is not completely inserted in the electrical outlet.	<ul style="list-style-type: none"> <li>• Make sure electrical plug is plugged into a live, properly grounded outlet.</li> </ul>
	A fuse in your home may be blown or the circuit breaker tripped.	<ul style="list-style-type: none"> <li>• Replace the fuse or reset the circuit breaker.</li> </ul>
	Oven controls improperly set.	<ul style="list-style-type: none"> <li>• See the <i>Using the kitchen timer</i> section.</li> </ul>
Oven will not self-clean	The oven temperature is too high to set a self-clean operation.	<ul style="list-style-type: none"> <li>• Allow the range to cool and reset the controls.</li> </ul>
	Oven controls improperly set.	<ul style="list-style-type: none"> <li>• See the <i>Using the self-cleaning oven</i> section.</li> </ul>
	The probe is plugged into the outlet in the oven. (on some models)	<ul style="list-style-type: none"> <li>• Remove the probe from the oven.</li> </ul>
"Crackling" or "popping" sound	This is the sound of the metal heating and cooling during both the cooking and cleaning functions.	<ul style="list-style-type: none"> <li>• This is normal.</li> </ul>
Excessive smoking during a clean cycle	Excessive soil.	<ul style="list-style-type: none"> <li>• Touch the <b>CLEAR/OFF</b> pad. Open the windows to rid the room of smoke. Wait until <b>LOCKED/DOOR</b>  goes off. After the oven cools, wipe up the excess soil and reset the clean cycle.</li> </ul>
Oven door will not open after a clean cycle	Oven too hot.	<ul style="list-style-type: none"> <li>• Allow the oven to cool below locking temperature.</li> </ul>
Oven not clean after a clean cycle	Oven controls not properly set.	<ul style="list-style-type: none"> <li>• See the <i>Using the self-cleaning oven</i> or <i>Using steam clean</i> section.</li> </ul>
	Oven was heavily soiled.	<ul style="list-style-type: none"> <li>• Clean up heavy spillovers before starting the clean cycle. Heavily soiled ovens may need to be cleaned again.</li> </ul>
"LOCKED" flashes in the display	The self-clean cycle has been selected but the door is not closed.	<ul style="list-style-type: none"> <li>• Close the oven door.</li> </ul>
"LOCKED" is on when you want to cook	The oven door is locked because the temperature inside the oven has not dropped below the locking temperature.	<ul style="list-style-type: none"> <li>• Touch the <b>CLEAR/OFF</b> pad. Allow the oven to cool.</li> </ul>
"F—" and a number or letter flash in the display	You have a function error code.	<ul style="list-style-type: none"> <li>• Disconnect all power to the range for at least 30 seconds and then reconnect power. If the function error code repeats, call for service.</li> </ul>

<b>Problem</b>	<b>Possible Causes</b>	<b>What To Do</b>
<b>Control signals after entering cooking time or start time</b>	You forgot to enter a bake temperature or cleaning time.	<ul style="list-style-type: none"> <li>• Touch the <b>BAKE</b> pad and desired temperature or the <b>SELF CLEAN</b> pad and desired clean time.</li> </ul>
<b>Display goes blank</b>	A fuse in your home may be blown or the circuit breaker tripped.	<ul style="list-style-type: none"> <li>• Replace the fuse or reset the circuit breaker.</li> </ul>
	The clock is in the black-out mode.	<ul style="list-style-type: none"> <li>• See the <i>Special features of your oven control</i> section.</li> </ul>
<b>Display flashes</b>	Power failure.	<ul style="list-style-type: none"> <li>• Reset the clock.</li> </ul>
<b>Unable to get the display to show "SF"</b>	Oven control pads were not touched properly.	<ul style="list-style-type: none"> <li>• The <b>BROIL HI/LO</b> and <b>BAKE</b> pads must be touched at the same time and held for 3 seconds.</li> </ul>
<b>"Probe" appears in the display (on some models)</b>	This is reminding you to enter a probe temperature after plugging in the probe.	<ul style="list-style-type: none"> <li>• Enter a probe temperature.</li> </ul>
<b>Power outage, clock flashes</b>	Power outage or surge.	<ul style="list-style-type: none"> <li>• Reset the clock. If the oven was in use, you must reset it by touching the <b>CLEAR/OFF</b> pad, setting the clock and resetting any cooking function.</li> </ul>
<b>Steam from the vent</b>	When using the ovens, it is normal to see steam coming out of the oven vents. As the number of racks or amount of food being cooked increases, the amount of visible steam will increase.	<ul style="list-style-type: none"> <li>• This is normal.</li> </ul>
<b>"Burning" or "oily" odor emitting from the vent</b>	This is normal in a new oven and will disappear in time.	<ul style="list-style-type: none"> <li>• To speed the process, set a self-clean cycle for a minimum of 3 hours. See the <i>Using the self-cleaning oven</i> section.</li> </ul>
<b>Strong odor</b>	An odor from the insulation around the inside of the oven is normal for the first few times the oven is used.	<ul style="list-style-type: none"> <li>• This is temporary.</li> </ul>
<b>Fan noise (on some models)</b>	A convection fan may automatically turn on and off.	<ul style="list-style-type: none"> <li>• This is normal. The fan is designed to operate intermittently to maximize cooking evenness.</li> <li>• The convection fan will operate during preheat of the bake cycle. The fan will turn off after the oven is heated to the set temperature. This is normal.</li> </ul>
	A cooling fan may automatically turn on and off.	<ul style="list-style-type: none"> <li>• This is normal on some models. The cooling fan will turn off and on to cool internal parts. It may run after the oven is turned off.</li> </ul>

## Before You Call For Service...



### Troubleshooting Tips

<b>Problem</b>	<b>Possible Causes</b>	<b>What To Do</b>
<b>Oven racks are difficult to slide</b>	The shiny, silver-colored racks were cleaned in a self-clean cycle.	<ul style="list-style-type: none"> <li>Apply a small amount of vegetable oil to a paper towel and wipe the edges of the oven racks with the paper towel. Do not spray with Pam® or other lubricant sprays.</li> </ul>
<b>Drawer does not slide smoothly or drags</b>	The drawer is out of alignment.	<ul style="list-style-type: none"> <li>Fully extend the drawer and push it all the way in. See the <i>Care and cleaning of the range</i> section.</li> </ul>
	Drawer is over-loaded or load is unbalanced.	<ul style="list-style-type: none"> <li>Reduce weight. Redistribute drawer contents.</li> </ul>
<b>Warming drawer will not work</b>	A fuse in your home may be blown or the circuit breaker tripped.	<ul style="list-style-type: none"> <li>Replace the fuse or reset the circuit breaker.</li> </ul>
	Controls improperly set.	<ul style="list-style-type: none"> <li>See the <i>Using the warming drawer</i> section.</li> </ul>
<b>Excessive condensation in the drawer</b>	Liquid in drawer.	<ul style="list-style-type: none"> <li>Remove liquid.</li> </ul>
	Uncovered foods.	<ul style="list-style-type: none"> <li>Cover food with lid or aluminum foil.</li> </ul>
	Temperature setting too high.	<ul style="list-style-type: none"> <li>Reduce temperature setting.</li> </ul>
<b>Food dries out in the warming drawer</b>	Moisture escaping.	<ul style="list-style-type: none"> <li>Cover food with lid or aluminum foil.</li> </ul>
	Drawer not fully closed.	<ul style="list-style-type: none"> <li>Push drawer in until latch engages.</li> </ul>
<b>Water remaining on oven floor after Steam Clean cycle</b>	This is normal.	<ul style="list-style-type: none"> <li>Remove any remaining water with a dry cloth or sponge.</li> </ul>
<b>Oven will not steam clean</b>	Display flashes HOT.	<ul style="list-style-type: none"> <li>Allow the oven to cool to room temperature and reset the controls.</li> </ul>
	Oven controls improperly set.	<ul style="list-style-type: none"> <li>See the <i>Using Steam Clean</i> section.</li> </ul>
	Oven door is not closed.	<ul style="list-style-type: none"> <li>Make sure you close the door to start steam clean cycle.</li> </ul>



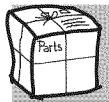

## Looking For Something More? (Not all accessories are available for all models.)

You can find these accessories and many more at [GEAppliances.com](http://GEAppliances.com) (U.S.) or [www.GEAppliances.ca](http://www.GEAppliances.ca) (Canada), or call **800.626.2002** (U.S.) or **800.661.1616** (Canada) (during normal business hours). Have your model number ready.

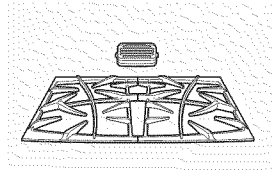

Grates

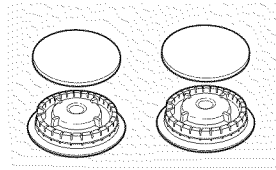

Surface Burner Heads and Caps

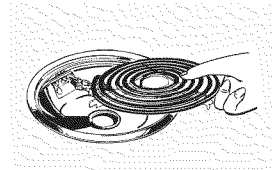

Surface Elements and Drip Pans

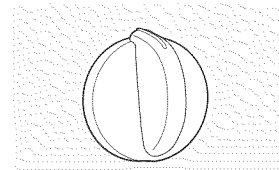

Knobs

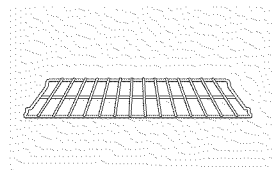

Oven Racks

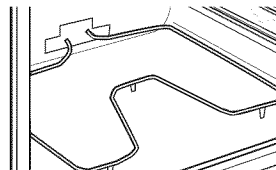

Oven Elements

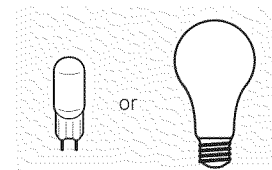

Light Bulbs

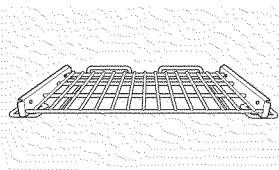

Extension Rack\*

\*If your model included an extension rack, you can increase the functionality of your range when you purchase additional extension racks. Visit [www.geapplianceparts.com](http://www.geapplianceparts.com) or call 800-626-2002, and order part number WB48T10071. Please note, extension racks do not fit all model ranges.

### Experience these other great products to keep your kitchen looking great!



Ceramic Cooktop Cleaning Kit: Includes cleaner, scraper and pad  
WX10X117GCS



Ceramic Cooktop Cleaning Wipes  
WX10X305



Stainless Steel Appliance Polish Wipes  
WX10X10001



Stainless Steel Appliance Cleaner  
PM10X311

Get the most out of your Broiler Pan! (Not for use with Broiler Drawer models.)

Use your pan and grid cover to broil hamburgers, seafood, steaks, vegetables, bacon, chops and so much more! The pan below catches the excess fats and oils.

- Genuine GE Part
- Easy To Clean
- One-Year Warranty

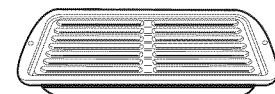

### Limited Time Offer! Free Shipping!

When you order your broiler pan within 30 days of purchasing your GE cooking product.

	Small	Large*	XL**
U.S. Part #	WB48X10055	WB48X10056	WB48X10057
Dimensions	8-3/4" W x 1-1/4" H x 13-1/2" D	12-3/4" W x 1-1/4" H x 15-1/4" D	15-1/2" W x 1-1/4" H x 19" D

\* The large (standard) broil pan does not fit in 20"/24" ranges.

\*\* The XL pan does not fit in 24" wall ovens, 27" drop-ins or 20"/24" ranges.

To place your order, call 800.626.2002 (U.S.), 800.661.1616 (Canada) or mail this form to:

In the U.S.: GE Parts, P.O. Box 221027, Memphis, TN 38122-1027. In Canada: GE Parts, 1 Factory Lane, Moncton, N.B. E1C 9M3



## Broiler Pan Order Form

Quantity \_\_\_\_\_ Part Number \_\_\_\_\_

Model Number \_\_\_\_\_ Serial Number \_\_\_\_\_ Brand \_\_\_\_\_ Date of Purchase \_\_\_\_\_

First Name \_\_\_\_\_ Last Name \_\_\_\_\_

Address \_\_\_\_\_

City \_\_\_\_\_ State \_\_\_\_\_ Zip Code \_\_\_\_\_

Phone \_\_\_\_\_ E-Mail \_\_\_\_\_

Check \_\_\_\_\_ Money Order \_\_\_\_\_

Call 800.626.2002 in the U.S. or 800.661.6161 in Canada for current pricing. All credit card orders must be called in.

*Notes.*

---

# GE Electric Range Warranty.

GEAppliances.com

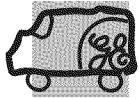

All warranty service provided by our Factory Service Centers, or an authorized Customer Care® technician. To schedule service, visit us on-line at [GEAppliances.com](http://GEAppliances.com), or call 800.GE.CARES (800.432.2737). Please have serial number and model number available when calling for service.

Staple your receipt here.  
Proof of the original purchase date is needed to obtain service under the warranty.

## For The Period Of: GE Will Provide:

### One Year

From the date of the original purchase

**Any part** of the range which fails due to a defect in materials or workmanship.

During this **limited one-year warranty**, GE will also provide, **free of charge**, all labor and in-home service to replace the defective part.

### For Profile Models:

#### Five Years

From the date of the original purchase

### For Profile Models:

**A replacement glass cooktop** if it should crack due to thermal shock, discolor or if the pattern wears off.

**A replacement radiant surface element** if it should burn out.

During this **limited additional four-year warranty**, you will be responsible for any labor or in-home service.

## What GE Will Not Cover:

- Service trips to your home to teach you how to use the product.
- Improper installation, delivery or maintenance.
- Product damage or failure of the product if it is abused, misused, modified, used for other than the intended purpose, or used commercially.
- Damage to the glass cooktop caused by use of cleaners other than the recommended cleaning creams and pads.
- Damage to the glass cooktop caused by hardened spills of sugary materials or melted plastic that are not cleaned according to the directions in the Owner's Manual.
- Replacement of house fuses or resetting of circuit breakers.
- Damage to the product caused by accident, fire, floods or acts of God.
- Incidental or consequential damage caused by possible defects with this appliance.
- Damage caused after delivery.
- Product not accessible to provide required service.

**EXCLUSION OF IMPLIED WARRANTIES—Your sole and exclusive remedy is product repair as provided in this Limited Warranty. Any implied warranties, including the implied warranties of merchantability or fitness for a particular purpose, are limited to one year or the shortest period allowed by law.**

This warranty is extended to the original purchaser and any succeeding owner for products purchased for home use within the USA. If the product is located in an area where service by a GE Authorized Servicer is not available, you may be responsible for a trip charge or you may be required to bring the product to an Authorized GE Service location for service. In Alaska, the warranty excludes the cost of shipping or service calls to your home.

Some states do not allow the exclusion or limitation of incidental or consequential damages. This warranty gives you specific legal rights, and you may also have other rights which vary from state to state. To know what your legal rights are, consult your local or state consumer affairs office or your state's Attorney General.

Warrantor: General Electric Company, Louisville, KY 40225

## Consumer Support.

---



### GE Appliances Website

[GEAppliances.com](http://GEAppliances.com)

Have a question or need assistance with your appliance? Try the GE Appliances Website 24 hours a day, any day of the year! For greater convenience and faster service, you can now download Owner's Manuals, order parts or even schedule service on-line.

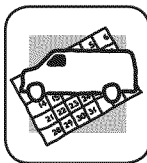

### Schedule Service

[GEAppliances.com](http://GEAppliances.com)

Expert GE repair service is only one step away from your door. Get on-line and schedule your service at your convenience any day of the year! Or call 800.GE.CARES (800.432.2737) during normal business hours.

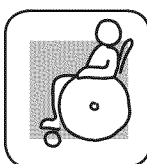

### Real Life Design Studio

[GEAppliances.com](http://GEAppliances.com)

GE supports the Universal Design concept—products, services and environments that can be used by people of all ages, sizes and capabilities. We recognize the need to design for a wide range of physical and mental abilities and impairments. For details of GE's Universal Design applications, including kitchen design ideas for people with disabilities, check out our Website today. For the hearing impaired, please call 800.TDD.GEAC (800.833.4322).



### Extended Warranties

[GEAppliances.com](http://GEAppliances.com)

Purchase a GE extended warranty and learn about special discounts that are available while your warranty is still in effect. You can purchase it on-line anytime, or call 800.626.2224 during normal business hours. GE Consumer Home Services will still be there after your warranty expires.

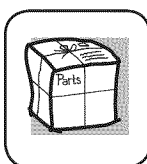

### Parts and Accessories

[GEAppliances.com](http://GEAppliances.com)

Individuals qualified to service their own appliances can have parts or accessories sent directly to their homes (VISA, MasterCard and Discover cards are accepted). Order on-line today, 24 hours every day or by phone at 800.626.2002 during normal business hours.

**Instructions contained in this manual cover procedures to be performed by any user. Other servicing generally should be referred to qualified service personnel. Caution must be exercised, since improper servicing may cause unsafe operation.**



### Contact Us

[GEAppliances.com](http://GEAppliances.com)

If you are not satisfied with the service you receive from GE, contact us on our Website with all the details including your phone number, or write to:

General Manager, Customer Relations  
GE Appliances, Appliance Park  
Louisville, KY 40225



### Register Your Appliance

[GEAppliances.com](http://GEAppliances.com)

**Register your new appliance on-line—at your convenience!** Timely product registration will allow for enhanced communication and prompt service under the terms of your warranty, should the need arise. You may also mail in the pre-printed registration card included in the packing material.