



BY WHIRLPOOL CORPORATION

Use & Care

G U I D E

Microwave Hood Combination

A Note to You.....	2
Microwave Oven Safety	3
Getting to Know Your Microwave Oven.....	6
How your microwave oven works	6
Radio interference	6
Testing your microwave oven.....	6
Testing your dinnerware or cookware.....	6
Operating tips.....	7
Electrical connection.....	7
Microwave oven features	8
Control panel features	9
Using the fan	10
Using the cooktop/countertop light	11
Setting the clock.....	12
Using the minute timer	12
Using Your Microwave Oven	12
Cooking at different cook powers	13
Cooking with more than one cook cycle.....	14
Using COOK.....	14
Using DEFROST	14
Defrost chart.....	16
Defrosting tips.....	17
Using REHEAT	18
Using BEVERAGE	18
Using BAKED POTATO.....	18
Using POPCORN.....	19
Using ADD 1 MINUTE.....	19
Adding or subtracting cook time	19
Cooking Guide.....	20
Caring for Your Microwave Oven	21
Caring for the filters.....	22
Replacing the cooktop and oven lights.....	23
Questions and Answers.....	24
Troubleshooting.....	25
Requesting Assistance or Service	26
Warranty	28

1-800-447-6737

Call our Customer Interaction Center with questions or comments.

www.roperappliances.com

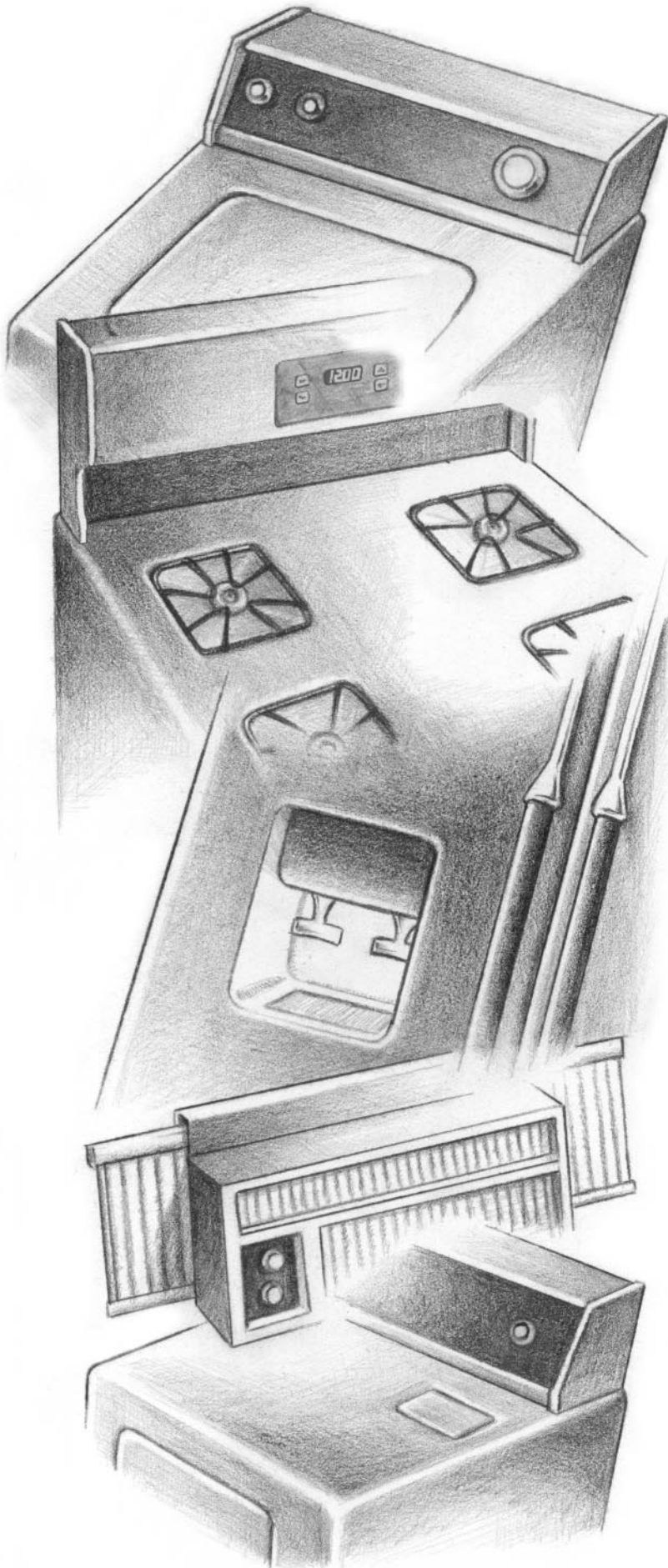

MODEL MHE13XK
3828W5A1790/8183776

A NOTE TO YOU

Thank you for buying a ROPER® appliance.

Your ROPER appliance gives you all the functionality of name brand appliances at a value price. To ensure that you enjoy years of trouble-free operation, we developed this Use and Care Guide. It is full of valuable information about how to operate and maintain your appliance properly. Please read it carefully.

Also, complete and mail the **Product Registration Card** provided with your appliance. The card helps us notify you about any new information on your appliance.

Please record your model's information.

Whenever you call to request service for your appliance, you need to know your complete model number and serial number. You can find this information on the model and serial number label/plate (see "Microwave oven features" in the "Getting to Know Your Microwave Oven" section). Also, record the other information shown in the next column.

Model Number _____

Serial Number _____

Purchase Date _____

Dealer Name _____

Dealer Address _____

Dealer Phone _____

Keep this book and the sales slip together in a safe place for future reference. It is important for you to save your sales receipt showing the date of purchase. Proof of purchase will assure you of in-warranty service.

Our Customer Interaction Center number is toll free.

1-800-447-6737

To find detailed product information, the location of the nearest Roper dealer or designated servicer, to purchase an accessory item, or register your appliance on-line, please visit our Web site at **www.roperappliances.com**

MICROWAVE OVEN SAFETY

Your safety and the safety of others are very important.

We have provided many important safety messages in this manual and on your appliance. Always read and obey all safety messages.



This is the safety alert symbol.

This symbol alerts you to potential hazards that can kill or hurt you and others.

All safety messages will follow the safety alert symbol and either the word "DANGER" or "WARNING." These words mean:

! DANGER

You can be killed or seriously injured if you don't immediately follow instructions.

! WARNING

You can be killed or seriously injured if you don't follow instructions.

All safety messages will tell you what the potential hazard is, tell you how to reduce the chance of injury, and tell you what can happen if the instructions are not followed.

IMPORTANT SAFETY INSTRUCTIONS

When using electrical appliances basic safety precautions should be followed, including the following:

WARNING: To reduce the risk of burns, electric shock, fire, injury to persons, or exposure to excessive microwave energy:

- Read all instructions before using the microwave oven.
- Read and follow the specific "PRECAUTIONS TO AVOID POSSIBLE EXPOSURE TO EXCESSIVE MICROWAVE ENERGY" found in this section.
- The microwave oven must be grounded. Connect only to properly grounded outlet. See "GROUNDING INSTRUCTIONS" found in this section and in the provided installation instructions.
- Install or locate the microwave oven only in accordance with the provided Installation Instructions.
- Some products such as whole eggs in the shell and sealed containers – for example, closed glass jars – may explode and should not be heated in the microwave oven.
- Use the microwave oven only for its intended use as described in this manual. Do not use corrosive chemicals or vapors in the microwave oven. This type of oven is specifically designed to heat, cook, or dry food. It is not designed for industrial or laboratory use.
- As with any appliance, close supervision is necessary when used by children.
- Do not operate the microwave oven if it has a damaged cord or plug, if it is not working properly, or if it has been damaged or dropped.
- The microwave oven should be serviced only by qualified service personnel. Call an authorized service company for examination, repair, or adjustment.
- See door surface cleaning instructions in the "Caring for Your Microwave Oven" section.
- To reduce the risk of fire in the oven cavity:
 - Do not overcook food. Carefully attend the microwave oven if paper, plastic, or other combustible materials are placed inside the oven to facilitate cooking.
 - Remove wire twist-ties from paper or plastic bags before placing bags in oven.
 - If materials inside the oven should ignite, keep oven door closed, turn oven off, and disconnect the power cord, or shut off power at the fuse or circuit breaker panel.
 - Do not use the cavity for storage purposes. Do not leave paper products, cooking utensils, or food in the cavity when not in use.
- Suitable for use above both gas and electric cooking equipment.

SAVE THESE INSTRUCTIONS

IMPORTANT SAFETY INSTRUCTIONS

- Intended to be used above ranges with maximum width of 36 inches.
- Clean Ventilating Hoods Frequently - Grease should not be allowed to accumulate on hood or filter.
- Oversized foods or oversized metal utensils should not be inserted in the microwave oven as they may create a fire or risk of electric shock.
- Do not clean with metal scouring pads. Pieces can burn off the pad and touch electrical parts involving a risk of electric shock.
- Do not use paper products when appliance is operated in the "PAN BROWN" mode.
- Do not store any materials other than manufacturer's recommended accessories in this oven when not in use.
- Do not store anything directly on top of the microwave oven when the microwave oven is in operation.
- When flaming foods under the hood, turn the fan on.
- Use care when cleaning the vent-hood filter. Corrosive cleaning agents, such as lye-based oven cleaners, may damage the filter.
- Do not cover or block any openings on the microwave oven.
- Do not store this microwave oven outdoors. Do not use the microwave oven near water – for example, near a kitchen sink, in a wet basement, or near a swimming pool, and the like.
- Do not immerse cord or plug in water.
- Keep cord away from heated surfaces.
- Do not let cord hang over edge of table or counter.
- Do not mount over a sink.
- Do not cover racks or any other part of the oven with metal foil. This will cause overheating of the oven.

SAVE THESE INSTRUCTIONS

PRECAUTIONS TO AVOID POSSIBLE EXPOSURE TO EXCESSIVE MICROWAVE ENERGY

- (a) Do not attempt to operate this oven with the door open since open-door operation can result in harmful exposure to microwave energy. It is important not to defeat or tamper with the safety interlocks.
- (b) Do not place any object between the oven front face and the door or allow soil or cleaner residue to accumulate on sealing surfaces.
- (c) Do not operate the oven if it is damaged. It is particularly important that the oven door close properly and that there is no damage to the:
 - (1) Door (bent),
 - (2) Hinges and latches (broken or loosened),
 - (3) Door seals and sealing surfaces.
- (d) The oven should not be adjusted or repaired by anyone except properly qualified service personnel.

ELECTRICAL REQUIREMENTS

Observe all governing codes and ordinances. A 120 Volt, 60 Hz, AC only, 20 amp fused electrical supply is required. (A time-delay fuse is recommended.) It is recommended that a separate circuit serving only this appliance be provided.

⚠ WARNING



Electrical Shock Hazard

Plug into a grounded 3 prong outlet.

Do not remove ground prong.

Do not use an adapter.

Do not use an extension cord.

Failure to follow these instructions can result in death, fire, or electrical shock.

GROUNDING INSTRUCTIONS

- **For all cord connected appliances:**

The microwave oven must be grounded. In the event of an electrical short circuit, grounding reduces the risk of electric shock by providing an escape wire for the electric current. The microwave oven is equipped with a cord having a grounding wire with a grounding plug. The plug must be plugged into an outlet that is properly installed and grounded.

WARNING: Improper use of the grounding plug can result in a risk of electric shock.

Consult a qualified electrician or serviceman if the grounding instructions are not completely understood, or if doubt exists as to whether the microwave oven is properly grounded.

Do not use an extension cord. If the power supply cord is too short, have a qualified electrician or serviceman install an outlet near the microwave oven.

- **For a permanently connected appliance:**

The microwave oven must be connected to a grounded, metallic, permanent wiring system, or an equipment grounding conductor should be run with the circuit conductors and connected to the equipment grounding terminal or lead on the microwave oven.

SAVE THESE INSTRUCTIONS

GETTING TO KNOW YOUR MICROWAVE OVEN

This section discusses the concepts behind microwave cooking. It also shows you the basics you need to know to operate your microwave oven. Please read this information before you use your oven.

HOW YOUR MICROWAVE OVEN WORKS

Microwave energy is not hot. It causes food to make its own heat, and it's this heat that cooks the food.

Microwaves are like TV waves, radio waves, or light waves. You cannot see them, but you can see what they do.

A **magnetron** in the microwave oven produces microwaves. The microwaves move into the oven where they contact food as it turns on the turntable.

The **glass turntable** of your microwave oven lets microwaves pass through. Then they bounce off a metal floor, back through the glass turntable, and are absorbed by the food.

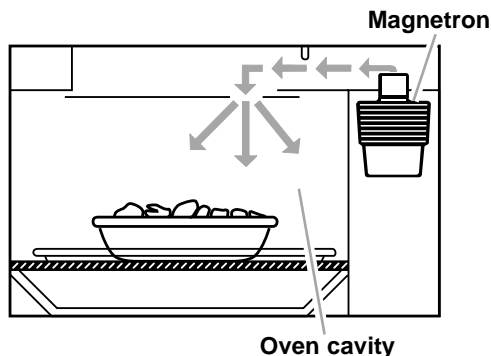

Microwaves pass through most glass, paper, and plastics without heating them so food absorbs the energy. Microwaves bounce off metal containers so food does not absorb the energy.

For the best cooking results

- **Always cook food** for the shortest cooking time recommended. Check to see how the food is cooking. If needed, **touch ADD 1 MINUTE** while the oven is operating or after the cooking cycle is over (see the "ADD 1 MINUTE" section).
- **To help make sure the food is evenly cooked, stir, turn over, or rearrange** the food about halfway through the cooking time.
- **If you do not have a cover for a dish,** use wax paper, or microwave-approved paper towels or plastic wrap. Remember to turn back a corner of the plastic wrap $\frac{1}{4}$ to $\frac{1}{2}$ in. (6.35 to 12.7 mm) to vent steam during heating or cooking.

RADIO INTERFERENCE

Using your microwave oven may cause interference to your radio, TV, or similar equipment. When there is interference, you can reduce it or remove it by:

- **Cleaning** the door and sealing surfaces of the oven.
- **Adjusting** the receiving antenna of the radio or television.
- **Moving** the receiver away from the microwave oven.
- **Plugging** the microwave oven into a different outlet so that the microwave oven and receiver are on different branch circuits.

TESTING YOUR MICROWAVE OVEN

To test the oven, put 1 cup (250 mL) of cold water in a glass container in the oven. Close the door. Make sure it latches. Cook at 100% power for 2 minutes. When the time is up, the water should be heated.

TESTING YOUR DINNERWARE OR COOKWARE

Test dinnerware or cookware before using. To test a dish, put it into the oven with 1 cup (250 mL) of water beside it. Cook at 100% cook power for one minute. **If the dish gets hot and water stays cool, do not use it.** Some dishes (melamine, some ceramic dinnerware, etc.) absorb microwave energy, and may become too hot to handle or may slow cooking times. Cooking in metal containers not designed for microwave use could damage the oven, as could containers with hidden metal (twist-ties, foil lining, staples, metallic glaze or trim).

OPERATING TIPS

- **Never** lean on the door or allow a child to swing on it when the door is open.
- **Use hot pads.** Microwave energy does not heat containers, but the heat from the food can make the container hot.
- **Do not** use newspaper or other printed paper in the oven.
- **Do not** dry flowers, fruit, herbs, wood, paper, gourds, or clothes in the oven.
- **Do not** start a microwave oven when it is empty. Product life may be shortened. If you practice programming the oven, **put** a container of water in the oven. It is normal for the oven door to look wavy after the oven has been running for a while.
- **Do not** try to melt paraffin wax in the oven. Paraffin wax will not melt in a microwave oven because it allows microwaves to pass through it.
- **Do not** operate the microwave oven unless the glass turntable is securely in place and can rotate freely. The turntable can rotate in either direction. **Make sure** the turntable is correct-side up in the oven. **Handle your turntable with care** when removing it from the oven to avoid possibly breaking it. If your turntable cracks or breaks, contact your dealer for a replacement.
- **When you use a browning dish,** the browning dish bottom must be at least $\frac{3}{16}$ in. (5 mm) above the turntable. Follow the directions supplied with the browning dish.
- **Never cook or reheat a whole egg inside the shell.** Steam buildup in whole eggs may cause them to burst, and possibly damage the oven. **Slice** hard-boiled eggs before heating. In rare cases, poached eggs have been known to explode. **Cover** poached eggs and **allow** a standing time of one minute before cutting into them.
- **For best results, stir any liquid several times during heating or reheating.** Liquids heated in certain containers (especially containers shaped like cylinders) may become overheated. The liquid may splash out with a loud noise during or after heating or when adding ingredients (coffee granules, tea bags, etc.). This can damage the oven.
- **Microwaves** may not reach the center of a roast. The heat spreads to the center from the outer, cooked areas just as in regular oven cooking. This is one of the reasons for letting some foods (for example, roasts or baked potatoes) stand for a while after cooking, or for stirring some foods during the cooking time.
- **Do not deep fry in the oven.** Microwavable utensils are not suitable and it is difficult to maintain appropriate deep-frying temperatures.
- **Do not overcook potatoes.** At the end of the recommended cooking time, potatoes should be slightly firm because they will continue cooking during standing time. **After microwaving, let potatoes stand for 5 minutes.** They will finish cooking while standing.

ELECTRICAL CONNECTION

If your electric power line or outlet voltage is less than 110 volts, cooking times may be longer. Have a qualified electrician check your electrical system.

MICROWAVE OVEN FEATURES

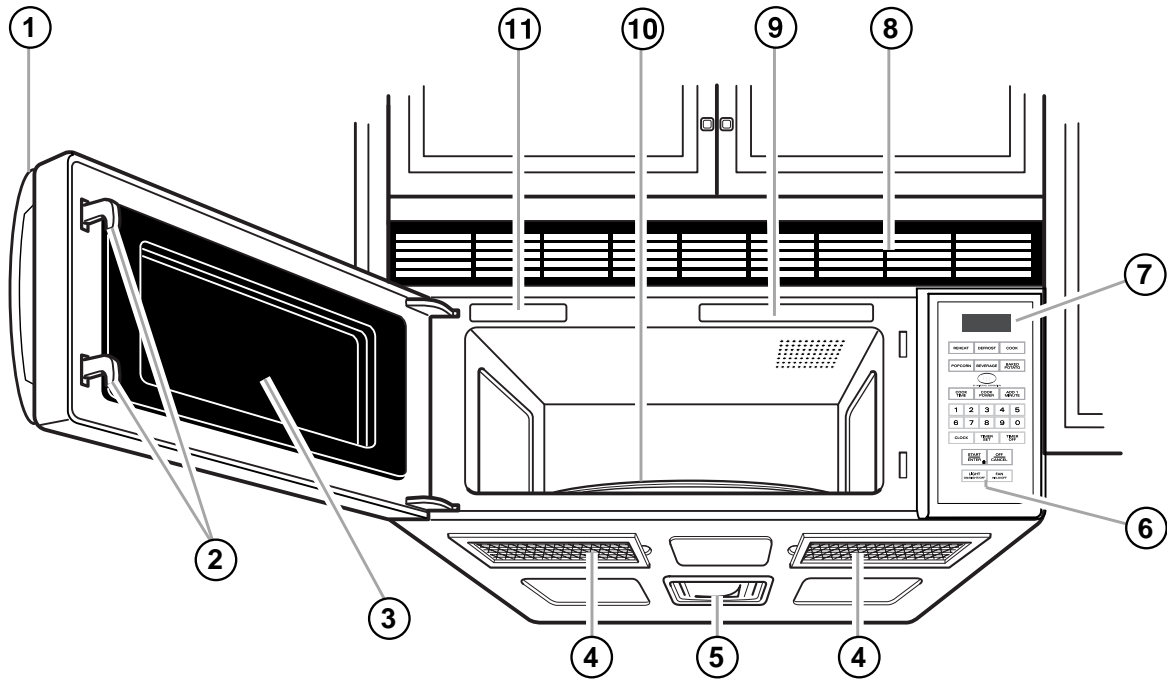

Your microwave oven is designed to make your cooking experience as enjoyable and productive as possible. To get you up and running quickly, the following is a list of the oven's basic features:

- 1. Door Handle.** Pull to open door.
- 2. Door Safety Lock System.** The oven will not operate unless the door is securely closed.
- 3. Window with Metal Shield.** Shield prevents microwaves from escaping. It is designed as a screen to allow you to view food as it cooks.
- 4. Filter.**
- 5. Cooktop/Countertop Light.** Turn on to light your cooktop or countertop or turn on as a night light.
- 6. Fan and Cooktop Light Switches.**
- 7. Control Panel.** Touch the pads on this panel to perform all functions.
- 8. Vent Grille.**
- 9. Cooking Guide.** Use as a quick reference for Cook and Defrost settings.
- 10. Glass Turntable.** The turntable turns food as it cooks for more even cooking. It must be in the oven during operation for best cooking results.
- 11. Model and Serial Number Plate.**

CONTROL PANEL FEATURES

Your microwave oven control panel lets you select a desired cooking function quickly and easily. The following is a list of all the Command and Number pads located on the control panel.

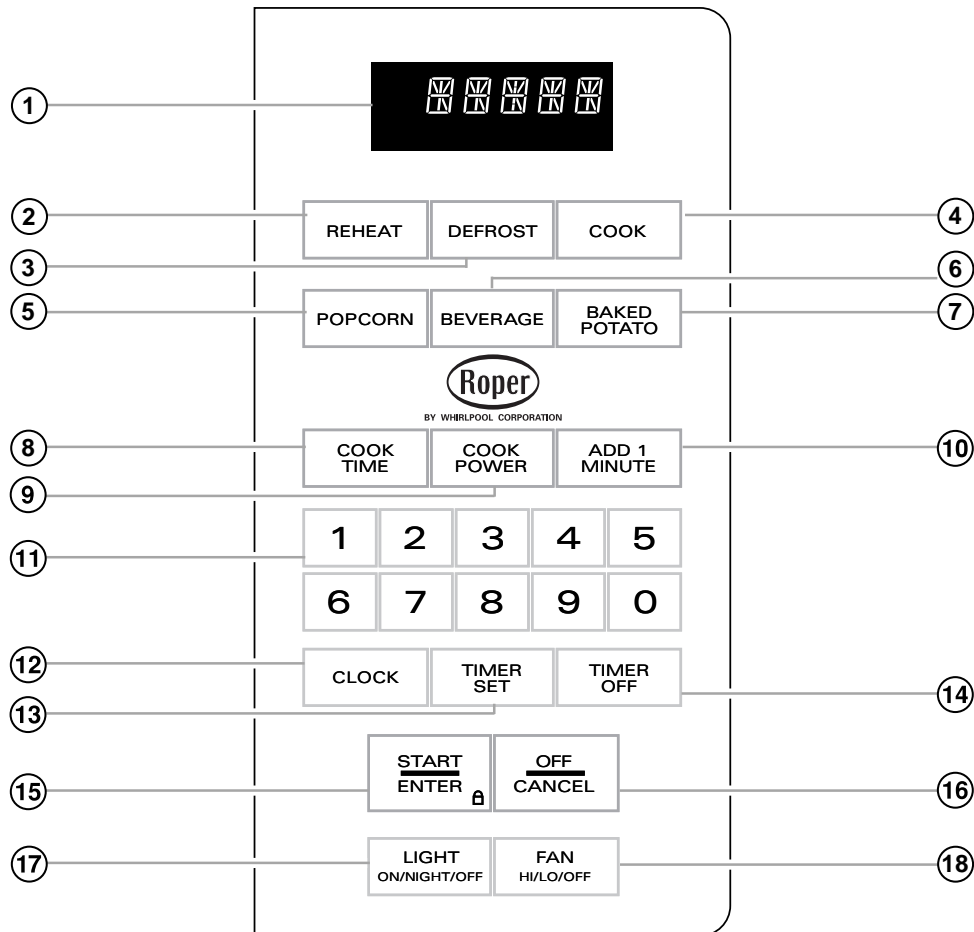

1. **Display.** The display includes a clock and indicators to tell you time of day, cooking time settings, and cooking functions selected.
2. **REHEAT.** Touch this pad to reheat food from 5 preset categories.
3. **DEFROST.** Touch this pad followed by Number pads to thaw frozen food by weight.
4. **COOK.** Touch this pad to cook common microwave-prepared foods without needing to program times and cook powers.
5. **POPCORN.** Touch this pad 1 to 3 times to pop a bag of popcorn in any of three sizes.
6. **BEVERAGE.** Touch this pad 1 to 2 times to reheat a beverage.
7. **BAKED POTATO.** Touch this pad 1 to 4 times to bake potatoes.
8. **COOK TIME.** Touch this pad followed by Number pads to set a cooking time.
9. **COOK POWER.** Touch this pad after the cook time has been set, followed by a Number pad to set the amount of microwave energy released to cook the food. The higher the number, the higher the microwave power or "cooking speed."
10. **ADD 1 MINUTE.** Touch this pad to cook for 1 minute at 100% cook power, or to add an extra minute to your cooking cycle.
11. **Number Pads.** Touch Number pads to enter cooking times, cook powers, temperatures, quantities, weights, or food categories.
12. **CLOCK.** Touch this pad to enter the correct time of day.
13. **TIMER SET.** Touch this pad to set the Minute Timer.
14. **TIMER OFF.** Touch this pad to cancel the Minute Timer.
15. **START/ENTER.** Touch this pad to start a function. If you open the door after the oven begins to cook, touch START/ENTER again to restart oven.
16. **OFF/CANCEL.** Touch this pad to erase an incorrect command, cancel a program during cooking, or to clear the display.
17. **LIGHT.** Touch this pad to turn on the cooktop/countertop light.
18. **FAN.** Touch this pad to turn the fan on or off.

NOTES:

- **If you have entered** all settings for a function but do not touch START/ENTER within 5 seconds, the START indicator light will flash.
- **If you open** the door while the oven is on and then shut the door, the START indicator light will flash. Touch START/ENTER to restart the oven.
- **If you choose** a function but do not press another Command pad within 1 minute, the display returns to the time of day and you have to start over.

Audible signals

Audible signals are available to guide you when setting and using your oven:

- **A programming tone will sound** each time you touch a pad.
- **One long tone** signals the end of a Minute Timer countdown.
- **Four tones** signal the end of a cooking cycle.
- **Two tones** sound once every minute after an End-of-Cooking signal as a reminder if food has not been removed from oven.
- **Three tones** sound if you have made an incorrect entry.

To disable all audible signals:

- **Touch and hold** Number pad 1 for 4 seconds to disable all programming tones.

To turn all signals back on:

Repeat step under “To disable all audible signals” above.

NOTE: Three tones, followed by two tones, will sound when audible signals are turned on or off. The three tones will be omitted if all tones are disabled.

Interrupting cooking

You can stop the oven during a cycle by opening the door. The oven stops heating and the fan stops, but the light stays on.

To restart cooking, close the door and touch START/ENTER.

If you do not want to continue cooking:

- **Close** the door and the light goes off.

OR

- **Touch** OFF/CANCEL.

Using the Child Lock

The Child Lock locks the control panel so children cannot use the microwave oven when you do not want them to.

To lock the control panel:

Touch and hold START/ENTER for 4 seconds. Three tones, followed by 2 tones, will sound and “LOC” will appear on the display.

To unlock the control panel:

Touch and hold START/ENTER for 4 seconds. Two tones will sound and “LOC” will be cleared from the display.

Using the Demo/Learning feature

You can see your microwave oven’s functions without turning the oven on.

Note: This feature can only be used when the microwave oven is first connected to power. You cannot use the Demo/Learning feature after a Command pad has been touched.

To set the Demo/Learning feature:

1. **Open** the door and **keep** it open.
2. **Touch and hold** Number pad 0 for 4 seconds. Three tones, followed by two tones, will sound.
3. **Release** Number pad 0.
4. **Shut** the door to start the Demo/Learning feature.

To cancel the Demo/Learning feature:

Touch OFF/CANCEL.

USING THE FAN

The pad on the bottom right of the control panel controls the 2-speed Fan.

1. Choose fan speed.

Press FAN once for HIGH, twice for LOW.

NOTE: If the temperature gets too hot around the microwave oven, the exhaust fan in the vent hood will automatically turn on at the LOW setting to protect the oven. It may stay on up to an hour to cool the oven. When this occurs, you cannot turn the fan off manually.

2. Turn fan off when desired.

Press FAN until it turns off.

To set fan to run for a specific time:**1. Touch FAN.**
(once or twice)

2. Touch TIMER SET.

Once, display will show "TIMER".

Twice, display will show "FAN", then "HR : MN".

NOTES:

- **Be sure** you have set a time of day with the Clock function before setting any Timer function.
- **If both** the fan and light are operating and TIMER is touched twice, both the fan and light will be controlled by the timer. The display will alternate between "FAN" and "LIGHT" one time before "HR:MN" is displayed.

3. Set fan run time.

Example to run the fan for 1 hour and 30 minutes:

Touch "1 3 0" and display will show "1 : 30".

4. Start Timed Fan Function.

Touch "START/ENTER" or "TIMER SET" and display will show "F 1 : 30".

NOTE: The letter "F" indicates the Timed Fan feature has been selected. If both the Timed Fan and Light feature have been selected, an "H" (Hood) will be displayed.

At end of time, the current time of day will show and no tones will sound.

To cancel the Timed Fan function:

NOTE: Touching TIMER OFF shuts off both the fan and timed function. Touching FAN shuts off just the fan.

USING THE COOKTOP/COUNTER-TOP LIGHT

The pad on the bottom left of the control panel controls the cooktop/countertop light.

Turn on/off light.

Press LIGHT once for HIGH, twice for LOW (night), three times to turn off.

To set light to be on for a specific time:**1. Touch LIGHT.**
(once or twice)

2. Touch TIMER SET.

Once, display will show "TIMER".

Twice, display will show "FAN", then "HR : MN".

NOTES:

- **Be sure** you have set a time of day with the Clock function before setting any Timer function.
- **If both** the fan and light are operating and TIMER is touched twice, both the fan and light will be controlled by the timer. The display will alternate between "FAN" and "LIGHT" one time before "HR:MN" is displayed.

3. Set light on time.

Example to turn light on for 1 hour and 30 minutes:

Touch "1 3 0" and display will show "1 : 30".

4. Start Timed Light function.

Touch "START/ENTER" or "TIMER SET" and display will show "L 1 : 30".

NOTE: The letter "L" indicates the Timed Light feature has been selected. If both the Timed Light and Fan feature have been selected, an "H" (Hood) will be displayed.

At end of time, the current time of day will show and no tones will sound.

To cancel the Timed Light function:

NOTE: Touching TIMER OFF shuts off both the light and timed function. Touching LIGHT shuts off just the light.

SETTING THE CLOCK

When your microwave oven is first plugged in or after a power failure, the display will show "88:88." For the first 30 seconds after the power is on, you can set the clock time without touching CLOCK. After 30 seconds has gone by, you must follow the directions below to set the time. If a time of day is not set, "88:88" will show on the display until you touch CLOCK.

NOTES:

- **You can** only set the clock if the oven is not cooking food.
- **If you enter** an incorrect time and touch CLOCK, three tones will sound. Enter the correct time.
- **If you touch** OFF/CANCEL while setting the clock, the display will show the last time of day set or ":" if no time of day has been set.

To set time:

1. Touch CLOCK.

2. Enter time of day.

Example for 12:00: Touch "1 2 0 0". Then **touch** CLOCK or START/ENTER.

USING THE MINUTE TIMER

You can use your microwave oven as a minute timer. Use the Minute Timer for timing up to 99 minutes, 99 seconds.

NOTE: The oven can operate while the Minute Timer is in use. To see the Minute Timer while the oven is cooking, touch TIMER SET. To return the display to the cooking time countdown, touch TIMER SET again.

1. Touch TIMER SET.

2. Enter time to be counted down.

Example for 1 minute, 30 seconds: **Touch** "1 3 0".

NOTE: If you enter more than 4 digits, 3 tones will sound. Touch START/ENTER to count down the 3-digit time you have entered or touch TIMER OFF to clear the display. To start over, touch TIMER SET and re-enter desired time.

3. Start countdown.

Touch START/ENTER or TIMER SET.

NOTE: If you do not do this step within 3 seconds of doing Step 2, "START" will flash. You then have 1 minute to touch START/ENTER or TIMER SET before the display returns to time of day.

At end of countdown: "End" will be displayed on the screen and one tone will sound.

To cancel Minute Timer:

During countdown: **Touch** TIMER OFF.

After countdown: **Touch** OFF/CANCEL.

USING YOUR MICROWAVE OVEN

This section gives you instructions for operating each function. Please read these instructions carefully.

1. Put food in oven and close the door.

2. Set cooking time.

Touch COOK TIME.

Example for 7 minutes, 30 seconds: Touch "7 3 0".

3. Set cook power.

Touch COOK POWER, enter level 1-10.

See "Cooking at different cook powers" for recommended cook powers.

NOTE: This step is not necessary to cook at High Power.

4. Start oven.

Touch START/ENTER.

At end of cooking time: Display will show "END".

Changing instructions

You can change the cooking time or cook power after cooking starts by repeating Steps 2 and/or 3 and 4.

COOKING AT DIFFERENT COOK POWERS

For best results, some recipes call for different cook powers. The lower the cook power, the slower the cooking. Each Number pad also stands for a different percentage of cook power. Many microwave cook-book recipes tell you by number, percent, or name which cook power to use.

The following chart gives the percentage of cook power each Number pad stands for, and the cook power name usually used. It also tells you when to use each cook power. Follow recipe or food package instructions if available.

NOTE: Refer to a reliable cookbook for cooking times.

COOK POWER	NAME	WHEN TO USE IT
100% of full power	High	<ul style="list-style-type: none"> • Quick heating many convenience foods and foods with high water content, such as soups, beverages and vegetables
90% of full power		<ul style="list-style-type: none"> • Cooking small tender pieces of meat, ground meat, poultry pieces and fish fillets • Heating cream soups
80% of full power		<ul style="list-style-type: none"> • Heating rice, pasta, or stirrable casseroles • Cooking and heating foods that need a cook power lower than high (for example, whole fish and meat loaf)
70% of full power	Medium-High	<ul style="list-style-type: none"> • Reheating a single serving of food
60% of full power		<ul style="list-style-type: none"> • Cooking sensitive foods, such as cheese and egg dishes, pudding, and custards • Cooking non-stirrable casseroles, such as lasagna
50% of full power	Medium	<ul style="list-style-type: none"> • Cooking ham, whole poultry, and pot roasts • Simmering stews
40% of full power		<ul style="list-style-type: none"> • Melting chocolate • Heating bread, rolls, and pastries
30% of full power	Medium-Low, Defrost	<ul style="list-style-type: none"> • Defrosting foods, such as bread, fish, meats, poultry, and precooked foods
20% of full power		<ul style="list-style-type: none"> • Softening butter, cheese, and ice cream
10% of full power	Low	<ul style="list-style-type: none"> • Keeping food warm • Taking chill out of fruit

NOTE: Once cook time has been entered you can also use the COOK POWER pad as a second Minute Timer by entering "0" for the cook power. The oven will count down the cooking time you set without cooking.

COOKING WITH MORE THAN ONE COOK CYCLE

For best results, some recipes call for one cook power for a certain length of time, and another cook power for another length of time. Your oven can be set to change from one to another automatically, for up to two cycles.

1. Put food in oven and close the door.

2. Set cooking time for first cycle.

Touch COOK TIME and the desired amount of time.

3. Set cook power for first cycle.

Touch COOK POWER and desired power level for first cycle.

4. Repeat Steps 2 and 3 to set cooking time and cook power for the second cycle.

5. Start oven.

Touch START/ENTER.

After the first cycle is over, the next cycle will count down.

At end of cooking time: The display will show "END".

Changing instructions

You can change times or cook powers for a cycle any time after that cycle starts by repeating Steps 2 and/or 3 and 4.

USING COOK

Cooking with COOK lets you heat common microwave-prepared foods without needing to program times and cook powers. COOK has preset times and cook powers for 3 food categories: Casserole, Bacon, and Rice.

To use COOK:

- 1. Touch** COOK once for Casserole, twice for Bacon, or three times for Rice.
- 2. Wait** 4 seconds.
- 3. Touch** COOK again to increase the number of cups/items.

Refer to the following chart for quantities:

CATEGORY	NUMBER OF CUPS/ITEMS
Casserole	1, 2, 3, 4 cups (250, 500, 750, 1000 mL)
Bacon	2, 4, 6, 8 slices
Rice	0.5, 1, 1.5, 2 cups (125, 250, 375, 500 mL)

NOTE: See "Microwave cooking chart" in the "Cooking Guide" section for cooking with COOK power and cooking time.

1. Put food in oven and close the door.

2. Choose COOK.

Example for Casserole: **Touch** COOK, display will show "CSRLE".

After 4 seconds: Display will show "1 CUP".

3. Increase quantity to 2 cups (500 mL) (within 3 seconds).

While display shows "1 CUP", you may increase the quantity to 2-4 cups (500-1000 mL) by pressing COOK repeatedly.

At end of cooking time: Display will show "END".

USING DEFROST

Your microwave oven automatically defrosts a variety of common meats at preset cook powers for preset times. The 3-stage defrost cycle is programmed for meat, poultry, and fish.

To use DEFROST:

- 1. Touch** DEFROST once for meat, twice for poultry, or three times for fish.
- 2. Wait** 4 seconds.
- 3. Enter** the weight using the Number pads.
- 4. Touch** START/ENTER.

After approximately one-third and two-thirds of the defrost cycle, the oven will stop and prompt you to turn the food over.

1. Put frozen food in oven and close the door.

NOTES:

- **Loosen or remove** any packaging, or covering on food.
- **See** the “Defrost chart” later in the “Using Your Microwave Oven” section for defrosting directions for each food.
- **To defrost items not listed** in “Defrost chart” use 30% cook power. Refer to a reliable cookbook for defrosting information.

Refer to the following chart to choose a category:

CATEGORY	Touch Defrost	WEIGHT
Meat	once	0.1 - 9.9 lbs (45.4 g - 4.49 kg)
Poultry	twice	0.1 - 9.9 lbs (45.4 g - 4.49 kg)
Fish	three times	0.1 - 9.9 lbs (45.4 g - 4.49 kg)

2. Choose DEFROST.

Example for meat:

Touch DEFROST,
once for meat,
twice for poultry,
three times for fish.

After 4 seconds, the display will prompt you to enter weight.

3. Enter food’s weight (in pounds and tenths of a pound).

Example for 1.2 lbs (.54 kg): Touch “1 2”.

NOTES:

- **For converting fractions** of a pound to decimals, see “Weight conversion chart” later in this section.
- **If you enter** an incorrect weight, touch DEFROST again and enter the correct weight.

4. Start oven.

Touch START/ENTER.

5. After a third of the cook time is over, display will prompt you to turn over food.

Open door, turn over food, and shield any warm portions.

NOTE: If you do not open the door within 2 minutes, the display will resume the countdown.

6. Close the door.

7. Restart oven.

Touch START/ENTER.

8. After two-thirds of the cook time is over, display will prompt you to turn food over. Repeat steps 5, 6, and 7.

At end of defrosting time: The display will show “END”.

DEFROST CHART

FOOD	AT PAUSE	SPECIAL INSTRUCTIONS
<p>Beef</p> <p>Ground Beef, Bulk</p> <p>Ground Beef, Patties</p> <p>Round Steak, Tenderloin Steak, Pot Roast, Chuck Roast, Rib Roast, Rump Roast</p> <p>Stew Beef</p>	<p>Remove thawed portions with fork. Turn over. Return remainder to oven.</p> <p>Separate and rearrange.</p> <p>Turn over. Cover warm areas with aluminum foil.</p> <p>Remove thawed portions with fork. Separate remainder. Return remainder to oven.</p>	<p>Meat of irregular shape and large, fatty cuts of meat should have the narrow or fatty areas shielded with foil at the beginning of a defrost cycle.</p> <p>Do not defrost less than ¼ lb (113 g).</p> <p>Do not defrost less than two 4 oz (113 g) patties.</p> <p>Place on a microwavable roasting rack.</p> <p>Place on a microwavable roasting rack.</p>
<p>Lamb</p> <p>Cubes for Stew</p> <p>Chops (1 in. [2.54 cm] thick)</p>	<p>Remove thawed portions with fork. Return remainder to oven.</p> <p>Separate and rearrange.</p>	<p>Place in a microwavable baking dish.</p> <p>Place on a microwavable roasting rack.</p>
<p>Pork</p> <p>Chops (½ in. [1.27 cm] thick), Hot Dogs, Sausage, Links</p> <p>Spareribs, Loin Roast, (Boneless)</p> <p>Sausage, Bulk</p>	<p>Separate and rearrange.</p> <p>Turn over. Cover warm areas with aluminum foil.</p> <p>Remove thawed portions with fork. Turn over. Return remainder to oven.</p>	<p>Place on a microwavable roasting rack.</p> <p>Place on a microwavable roasting rack.</p> <p>Place in a microwavable baking dish.</p>
<p>Fish</p> <p>Fillets</p> <p>Steaks</p> <p>Whole</p>	<p>Turn over. Separate fillets when partially thawed.</p> <p>Separate and rearrange.</p> <p>Turn over.</p>	<p>Place in a microwavable baking dish. Carefully separate fillets under cold water.</p> <p>Place in a microwavable baking dish. Run cold water over to finish defrosting.</p> <p>Place in a microwavable baking dish. Cover head and tail with foil; do not let foil touch sides of microwave oven. Finish defrosting by immersing in cold water.</p>
<p>Shellfish</p> <p>Crabmeat, Lobster Tails, Shrimp, Scallops</p>	<p>Break apart, turn over, and rearrange.</p>	<p>Place in a microwavable baking dish.</p>

DEFROST CHART (CONT.)

FOOD	AT PAUSE	SPECIAL INSTRUCTIONS
Chicken Whole (up to 4½ lbs [2.04 kg]) Cut Up	Turn over (finish defrosting breast-side down). Cover warm areas with aluminum foil. Separate pieces and rearrange. Turn over. Cover warm areas with aluminum foil.	Place chicken breast-side up on a microwavable roasting rack. Finish defrosting by immersing in cold water. Remove giblets when chicken is partially defrosted. Place on a microwavable roasting rack. Finish defrosting by immersing in cold water.
Cornish Hens Whole	Turn over. Cover warm areas with aluminum foil.	Place on a microwavable roasting rack. Finish defrosting by immersing in cold water.
Turkey Breast (under 6 lbs [2.72 kg])	Turn over. Cover warm areas with aluminum foil.	Place on a microwavable roasting rack. Finish defrosting by immersing in cold water.

DEFROSTING TIPS

- **When using DEFROST**, the weight to be entered is the net weight in pounds and tenths of pounds (the weight of the food minus the container).
- **Before starting**, make sure you have removed any of the metal twist-ties which often come with frozen food bags, and replace them with strings or elastic bands.
- **Open containers** such as cartons before they are placed in the oven.
- **Always slit** or pierce plastic pouches or packaging.
- **If food is foil wrapped**, remove foil and place it in a suitable container.
- **Slit** the skins, if any, of frozen food such as sausage.
- **Bend** plastic pouches of food to ensure even defrosting.
- **Always underestimate** defrosting time. If defrosted food is still icy in the center, return it to the microwave oven for more defrosting.
- **The length** of defrosting time varies according to how solidly the food is frozen.
- **The shape of the package** affects how quickly food will defrost. Shallow packages will defrost more quickly than a deep block.
- **As food begins to defrost**, separate the pieces. Separated pieces defrost more easily.
- **Use small pieces of aluminum foil** to shield parts of food such as chicken wings, leg tips, fish tails, or areas that start to get warm. Make sure the foil does not touch the sides, top, or bottom of the oven. The foil can damage the oven lining.
- **For better results**, let food stand after defrosting. (For more information on standing time, see “Microwave cooking tips” in the “Cooking Guide” section.)
- **Turn over** food during defrosting or standing time. Break apart and remove food as required.

Weight conversion chart

You are probably used to food weights as being in pounds and ounces that are fractions of a pound (for example, 4 ounces equals ¼ pound). However, in order to enter food weight in DEFROST, you must specify pounds and tenths of a pound.

If the weight on the food package is in fractions of a pound, you can use the following chart to convert the weight to decimals.

Equivalent Weight		
OUNCES	Metric (g)	DECIMAL WEIGHT
1.6	45.4	.10
3.2	90.7	.20
4.0	113.4	.25 One-Quarter Pound
4.8	136.1	.30
6.4	181.4	.40
8.0	226.8	.50 One-Half Pound
9.6	272.2	.60
11.2	317.5	.70
12.0	340.2	.75 Three-Quarters Pound
12.8	362.9	.80
14.4	408.2	.90
16.0	453.6	1.00 One Pound

USING REHEAT

You can reheat food by choosing a category and quantity. REHEAT has preset times and cook powers for five categories:

Pizza, Plate, Soup/Sauce, Casserole, and Baked Goods.

Refer to the following chart for quantities:

CATEGORY	NUMBER OF CUPS/ITEMS
Pizza (refrigerated)	1 to 3 slices, 5 oz (142 g) each
Plate (refrigerated)	1 to 2 servings
Soup/Sauce (room temperature)	1 to 4 cups (250-1000 mL)
Casserole (refrigerated)	1 to 4 cups (250-1000 mL)
Baked Goods (room temperature)	1 to 4 items, 2 oz (57 g) each

NOTE: See the “Reheating chart” in the “Cooking Guide” section for reheating with cook power and cooking time.

1. Put food in oven and close the door.

2. Touch REHEAT.

Once for Pizza, twice for Plate, three times for Soup/Sauce, four times for Casserole, and five times for Baked Goods.

After 4 seconds: The display will prompt you to enter the quantity.

3. Increase to 2 servings (within 3 seconds of step 2).

Touch REHEAT to cycle through quantity options.

At end of heating time: The display will show “END”.

USING BEVERAGE

BEVERAGE lets you heat a beverage by touching just one pad.

NOTE: If you want to change the heating time after choosing BEVERAGE, see the “Adding or subtracting cook time” at the end of the “Using Your Microwave Oven” section.

1. Place cup of beverage in oven and close the door.

2. Touch BEVERAGE.

once for 8 oz (227 g),
twice for 16 oz (454 g)

In 3 seconds, the display will start counting down.

At end of heating time: The display will show “END”.

USING BAKED POTATO

BAKED POTATO lets you cook potatoes (10 to 13 oz [283-369 g] each) by touching just one pad. With the preset times and cook powers, all you do is touch BAKED POTATO (1 to 4 times) to select the desired number of potatoes (1 to 4). Your microwave oven does the rest.

1. Place potatoes in oven and close the door.

NOTES:

- **Before baking**, pierce potato with fork several times.
- **After baking**, let stand for 5 minutes.

2. Touch BAKED POTATO.

1-4 times for 1-4 potatoes

After 3 seconds: The display will show remaining time.

At end of cooking time: The display will show “END”.

USING POPCORN

You can pop commercially packaged microwave popcorn by touching just one pad. The number of times you touch this pad determines which size of popcorn your oven will pop.

For best results:

- **Pop** only one package at a time.
- **If you are using** a microwave popcorn popper, follow the manufacturer’s instructions.
- **Cooking performance** may vary with brand and fat content. Try several brands to decide which gives best popping results.
- **Use** fresh bags of popcorn.

1. Place the bag in the center of the turntable and close the door.

To correctly set your microwave oven, follow this chart:

Bag Size –ounces	3.50 oz (100 g)	3.00 oz (85 g)	1.75 oz (50 g)
Touch POPCORN	once	twice	three times

NOTE: If you want to shorten or lengthen the cooking time after choosing POPCORN, see “Adding or subtracting cook time” at the end of the “Using Your Microwave Oven” section.

2. Touch POPCORN 1-3 times to cycle through popcorn bag sizes (3.5, 3.0, 1.75 oz [100, 85, 50 g])

After 3 seconds, oven starts popping popcorn: Every 10 seconds the display will alternate between “POP-” and “CORN” and then show the time remaining.
At end of popping time: The display will show “END”.

USING ADD 1 MINUTE

ADD 1 MINUTE lets you cook food for 1 minute at 100% cook power or add an extra minute to your cook time cycle. You can also use it to extend cook time cycles in multiples of 1 minute, up to 99 minutes.

NOTES:

- **To extend** cook time cycles in multiples of 1 minute, touch ADD 1 MINUTE repeatedly during cooking.
- **After closing the door**, you can enter ADD 1 MINUTE after touching START/ENTER.
- **If you touch** ADD 1 MINUTE during cooking, the oven will cook at the currently selected cook power. If you touch ADD 1 MINUTE after cooking is over, the oven will cook at 100% cook power.
- **You can use** ADD 1 MINUTE only for the cook time function.

1. Make sure food is in oven.

2. Touch ADD 1 MINUTE.

Each time you press ADD 1 MINUTE, the time is increased by one minute.

ADDING OR SUBTRACTING COOK TIME

If a preset cook time is too long or too short, you can increase or decrease the cook time by 10% after choosing the function. You can only increase or decrease cook time before cooking starts.

To increase cook time by 10%:



To decrease cook time by 10%:



To reset to the original cook time:



COOKING GUIDE

MICROWAVE COOKING TIPS

Amount of food

- **If you increase or decrease** the amount of food you prepare, the time it takes to cook that food will also change. For example, if you double a recipe, add a little more than half the original cooking time. Check for doneness and, if necessary, add more time in small increments.

Starting temperature of food

- **The lower the temperature** of the food being put into the microwave oven, the longer it takes to cook. Food at room temperature will be reheated more quickly than food at refrigerator temperature.

Composition of food

- **Food with a lot of fat and sugar** will be heated faster than food containing a lot of water. Fat and sugar will also reach a higher temperature than water in the cooking process.
- **The more dense the food**, the longer it takes to heat. “Very dense” food like meat takes longer to reheat than lighter, more porous food like sponge cakes.

Size and shape

- **Smaller pieces of food** will cook faster than larger pieces. Also, same-shaped pieces cook more evenly than different-shaped pieces.
- **With foods that have different thicknesses**, the thinner parts will cook faster than the thicker parts. **Place** the thinner parts of chicken wings and legs in the center of the dish.

Stirring, turning foods

- **Stirring and turning foods** spreads heat quickly to the center of the dish and avoids overcooking at the outer edges of the food.

Covering food

Cover food to:

- **Reduce** splattering
- **Shorten** cooking times
- **Keep** food moist

You can use any covering that lets microwaves pass through. See “Getting to Know Your Microwave Oven” for materials that microwaves will pass through.

Releasing pressure in foods

- **Several foods** (for example: baked potatoes, sausages, egg yolks, and some fruits) are tightly covered by a skin or membrane. Steam can build up under the membrane during cooking, causing the food to burst. To relieve the pressure and to prevent bursting, **pierce** these foods before cooking with a fork, cocktail pick, or toothpick.

Using standing time

- **Always allow food to stand** after cooking. Standing time after defrosting and cooking allows the temperature to evenly spread throughout the food, improving the cooking results.
- **The length of the standing time** depends on how much food you are cooking and how dense it is. Sometimes it can be as short as the time it takes you to remove the food from the oven and take it to the serving table. However, with larger, denser food, the standing time may be as long as 10 minutes.

Arranging food

For best results, place food evenly on the plate. You can do this in several ways:

- **If you are cooking several items of the same food**, such as baked potatoes, **place** them in a ring pattern for uniform cooking.
- **When cooking foods of uneven shapes or thickness, such as chicken breasts, place** the smaller or thinner area of the food towards the center of the dish where it will be heated last.
- **Layer thin slices of meat** on top of each other.
- **When you cook or reheat whole fish, score** the skin – this prevents cracking.
- **Do not** let food or a container touch the top or sides of the oven. This will prevent possible arcing.

Using aluminum foil

Metal containers should not be used in a microwave oven. There are, however, some exceptions. If you have purchased food which is prepackaged in an aluminum foil container, refer to the instructions on the package. When using aluminum foil containers, cooking times may be longer because microwaves will only penetrate the top of the food.

If you use aluminum containers without package instructions, follow these guidelines:

- **Place** the container in a glass bowl and add some water so that it covers the bottom of the container, not more than ¼ in. (.64 cm) high. This ensures even heating of the container bottom.

- **Always remove** the lid to avoid damage to the oven.
- **Use only** undamaged containers.
- **Do not use** containers taller than $\frac{3}{4}$ in. (1.9 cm).
- **Container must be** at least half filled.
- **To avoid arcing**, there must be a minimum $\frac{1}{4}$ in. (.64 cm) between the aluminum container and the walls of the oven and also between two aluminum containers.
- **Always place** the container on the turntable.
- **Reheating food** in aluminum foil containers usually takes up to double the time compared to reheating in plastic, glass, china, or paper containers. The time when food is ready will vary depending upon the type of container you use.
- **Let food stand** for 2 to 3 minutes after heating so that heat is spread evenly throughout container.

Cooking you should not do in your microwave oven

- **Do not** do canning of foods in the oven. Closed glass jars may explode, resulting in damage to the oven.
- **Do not** use the microwave oven to sterilize objects (baby bottles, etc.). It is difficult to keep the oven at the high temperature needed for sterilization.

CARING FOR YOUR MICROWAVE OVEN

To make sure your microwave oven looks good and works well for a long time, you should maintain it properly. For proper care, please follow these instructions carefully.

For interior surfaces: Wash often with warm, sudsy water and a sponge or soft cloth. Use only mild, non-abrasive soaps or a mild detergent. **Be sure to keep the areas clean where the door and oven frame touch when closed.** Wipe well with clean water. Over time, stains can occur on the surfaces as the result of food particles spattering during cooking. This is normal. For stubborn soil, **boil** a cup (250 mL) of water in the oven for 2 or 3 minutes. Steam will soften the soil. To get rid of odors inside the oven, **boil** a cup (250 mL) of water with lemon juice or vinegar.

For exterior surfaces and control panel: Use a soft cloth with spray glass cleaner. Apply the spray glass cleaner to the soft cloth; do not spray directly on the oven.

NOTE: Abrasive cleansers, steel-wool pads, gritty wash cloths, some paper towels, etc., can damage the control panel and the interior and exterior oven surfaces.

To clean turntable and turntable support, wash in mild, sudsy water; for heavily soiled areas **use** a mild cleanser and scouring sponge. The turntable and turntable support are dishwasher-safe.

CARING FOR THE FILTERS

The grease (aluminum) filters should be removed and cleaned often, at least once a month. You can order replacement grease filters (PN 4358853) from your nearest authorized Roper dealer.

If your microwave hood combination is installed to recirculate air, the charcoal filter should be installed. The charcoal filter cannot be washed. For best performance, we recommend that you replace charcoal filters every six to twelve months. You can order replacement charcoal filters (PN 4359416) from your nearest authorized Roper dealer.

! WARNING



Electrical Shock Hazard

Disconnect power before removing filters.
Replace all panels before operating.
Failure to do so can result in death or electrical shock.

Grease filters:

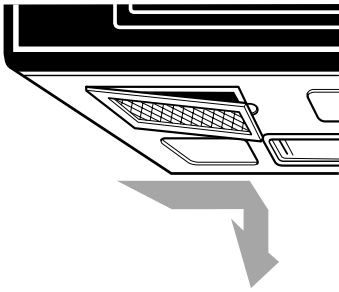

1. **Unplug** microwave oven or **disconnect** power.
2. To **remove grease filters**, **slide** each filter to the side. **Pull** filters downward and **push** to the other side. The filter will drop out.

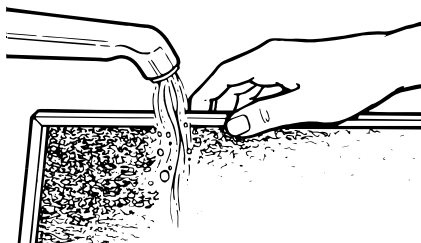

3. **Soak** grease filters in hot water and a mild detergent. **Scrub and swish** to remove embedded dirt

and grease. **Rinse well and shake** to dry. **Do not clean filters with ammonia, corrosive cleaning agents such as lye-based oven cleaners, or place them in a dishwasher. The filters will turn black or could be damaged.**



4. To **replace grease filters**, **slide** filter in the frame slot on one side of the opening. **Push** filter upward and **push** to the other side to lock into place.
5. **Plug** in microwave oven or **reconnect** power.

Charcoal filter:

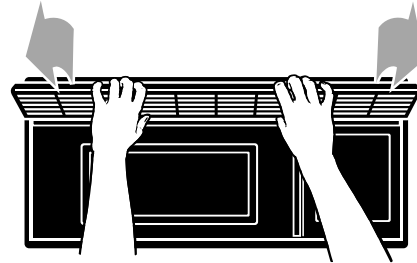

1. **Unplug** microwave oven or **disconnect** power.
2. **Remove** the vent cover mounting screws.
3. **Tip** the cover forward, then **lift out** to remove.

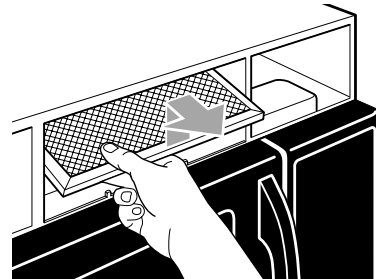

4. **Lift** the back of the charcoal filter. **Slide** the filter straight out.

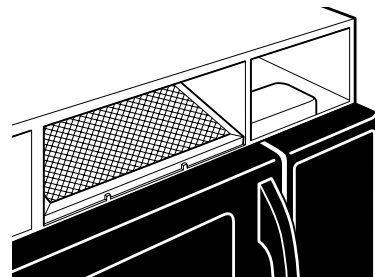

5. **Slide** a new charcoal filter into place. The filter should rest at the angle shown.

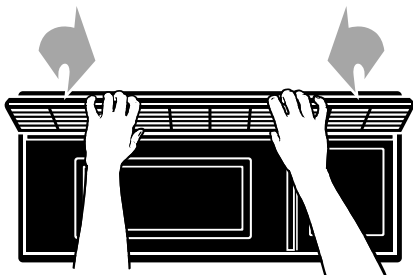

6. **Slide** the bottom of the vent cover into place. **Push** the top until it snaps into place. **Replace** the mounting screws.

7. **Plug** in microwave oven or **reconnect** power.

NOTE: Do not operate the hood without the grease filters in place.

REPLACING THE COOKTOP AND OVEN LIGHTS

The cooktop light

1. **Unplug** microwave oven or **disconnect** power.

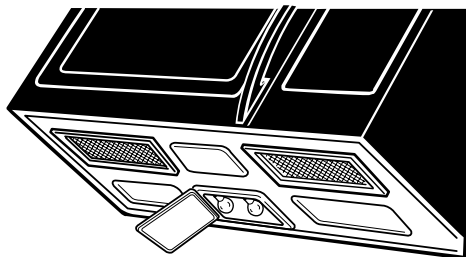

2. **Remove** the bulb cover mounting screws.

3. We recommend replacing bulb(s) with candelabra-base 40-watt bulb(s) available from your authorized service company, or by calling the Customer Interaction Center at **1-800-447-6737**. Make sure to have your model number when ordering.

4. **Plug** in microwave oven or **reconnect** power.

The oven light

1. **Unplug** microwave oven or **disconnect** power.

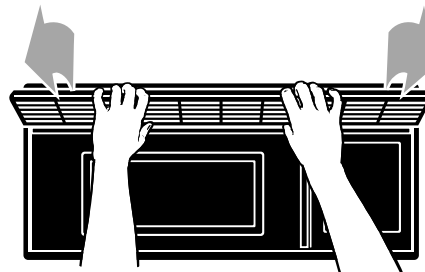

2. **Remove** the vent cover mounting screws.

3. **Tip** the cover forward, then **lift out** to remove.

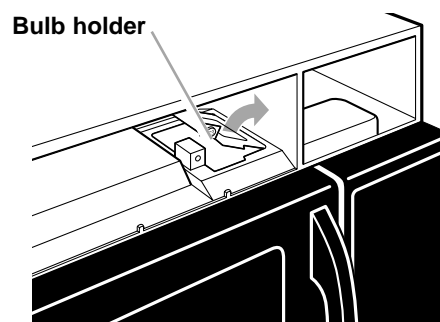

4. **Lift up** the bulb holder.

5. We recommend replacing the bulb with a candelabra-base 40-watt bulb available from your authorized service company, or by calling the Customer Interaction Center at **1-800-447-6737**. Make sure to have your model number when ordering.

6. **Replace** the bulb holder.

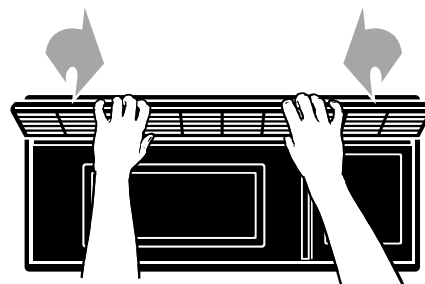

7. **Slide** the top of the vent cover into place. **Push** the bottom until it snaps into place. **Replace** the mounting screws.

8. **Plug** in microwave oven or **reconnect** power.

QUESTIONS AND ANSWERS

QUESTIONS	ANSWERS
Can I operate my microwave oven without the turntable or turn the turntable over to hold a large dish?	No. If you remove or turn over the turntable, you will get poor cooking results. Dishes used in your oven must fit on the turntable.
Can I use a rack in my microwave oven so that I may reheat or cook on two levels at a time?	You can use a rack only if the rack is supplied with your microwave oven. If you use a rack not supplied with the microwave oven, you can get poor cooking performance and/or arcing.
Can I use either metal or aluminum pans in my microwave oven?	You can use aluminum foil for shielding (use small, flat pieces), small skewers, and shallow foil trays (if tray is not taller than ¾ in. (19 mm) deep and half filled with food to absorb microwave energy). Never allow metal to touch walls or door.
Is it normal for the turntable to turn in either direction?	Yes. The turntable rotates clockwise or counter-clockwise, depending on the rotation of the motor when the cooking cycle begins.
Sometimes the door of my microwave oven appears wavy. Is this normal?	This appearance is normal and does not affect the operation of your oven.
What are the humming noises that I hear when my microwave oven is operating?	You may hear the sound of the transformer when the magnetron tube cycles on.
Why does the dish become hot when I microwave food in it? I thought that this should not happen.	As the food becomes hot it will conduct the heat to the dish. Be prepared to use hot pads to remove food after cooking.
What does “standing time” mean?	“Standing time” means that food should be removed from the oven and covered for additional time to allow it to finish cooking. This frees the oven for other cooking.
Why does steam come out of the air exhaust vent?	Steam is normally produced during cooking. The microwave oven has been designed to vent this steam out the vents.
Can I pop popcorn in my microwave oven? How do I get the best results?	Yes. Pop packaged microwave popcorn following manufacturer’s guidelines or use the preset POPCORN pad. Do not use regular paper bags. Use the “listening test” by stopping the oven as soon as the popping slows to a “pop” every 1 or 2 seconds. Do not repop unpopped kernels. Do not pop popcorn in glass cookware.

TROUBLESHOOTING

Most cooking problems often are caused by little things you can find and fix without tools of any kind. Check the lists below before calling for assistance or service. If you still need help, see the “Requesting Assistance or Service” section.

IF MICROWAVE DOES NOT OPERATE, FIRST CHECK THE FOLLOWING:

- Is the microwave plugged into a live outlet with the proper voltage? (See installation instructions.)
- Have you blown a household fuse or tripped a circuit breaker?
- Has the electric company experienced a power failure?

OTHER POSSIBLE PROBLEMS AND THEIR CAUSES:

Problem	Cause
The microwave oven will not run.	<ul style="list-style-type: none">● The door is not firmly closed and latched.● You did not touch START/ENTER.● You did not follow directions exactly.● An operation that was programmed earlier is still running.● You have not entered numbers after touching COOK TIME.
Microwave cooking times seem too long.	<ul style="list-style-type: none">● The electric supply to your home or wall outlets is low or lower than normal. Your electric company can tell you if the line voltage is low. Your electrician or service technician can tell you if the outlet voltage is low.● The cook power is not at the recommended setting.● Larger amounts of food need longer cooking times.
The turntable will not turn.	<ul style="list-style-type: none">● The turntable is not correctly in place. Make sure the turntable is correct-side up and is sitting securely on center shaft.● The support is not operating correctly. Remove turntable, check that the turntable support is properly in place, and restart oven. If turntable support does not move, call an designated service technician for repair. Cooking without the turntable can give you poor results.
The display shows a time counting down but the oven is not cooking.	<ul style="list-style-type: none">● The oven door is not closed completely.● You have set the controls as a kitchen timer. Touch OFF/CANCEL to cancel the Minute Timer.
You do not hear the Programming Tone.	<ul style="list-style-type: none">● The command is not correct.
The fan seems to be running slower than usual.	<ul style="list-style-type: none">● The oven has been stored in a cold area. The fan will run slower until the oven warms up to normal room temperature.
The display is showing “88:88”.	<ul style="list-style-type: none">● There has been a power interruption. Reset the clock.

If none of these items is causing your problem, see the “Requesting Assistance or Service” section on page 26.

REQUESTING ASSISTANCE OR SERVICE

To avoid unnecessary service calls, please check the “Troubleshooting” section. It may save you the cost of a service call. If you still need help, follow the instructions below.

IF YOU NEED ASSISTANCE OR SERVICE

Call our Customer Interaction Center at 1-800-447-6737. Our consultants are available to assist you.



When calling:

Please know the purchase date, and the complete model and serial number of your appliance (see the “A Note to You” section). This information will help us better respond to your request.

Our consultants provide assistance with:

- Features and specifications on our full line of appliances
- Installation information
- Use and maintenance procedures

- Accessory and repair parts sales
- Specialized customer assistance (Spanish speaking, hearing impaired, limited vision, etc.)
- Referrals to local dealers, service companies, and repair parts distributors

Whirlpool designated service technicians are trained to fulfill the product warranty and provide after-warranty service, anywhere in the United States.

To locate the Whirlpool designated service company in your area, you can also look in your telephone directory Yellow Pages.

FOR FURTHER ASSISTANCE

If you need further assistance, you can write to us with any questions or concerns at:

Roper Brand Home Appliances
Customer Interaction Center
c/o Correspondence Dept.
MD 8040
553 Benson Road
Benton Harbor, MI 49022-2400

Please include a daytime phone number in your correspondence.

WARRANTY

ROPER® MICROWAVE OVEN

LENGTH OF WARRANTY	WHIRLPOOL CORPORATION WILL PAY FOR:
FULL ONE-YEAR WARRANTY FROM DATE OF PURCHASE	FSP® replacement parts and repair labor to correct defects in materials or workmanship. Service must be provided by a Whirlpool designated service company.
LIMITED FOUR-YEAR WARRANTY SECOND THROUGH FIFTH YEAR FROM DATE OF PURCHASE	FSP® replacement magnetron tube on microwave ovens if defective in materials or workmanship.
WHIRLPOOL CORPORATION WILL NOT PAY FOR:	
<p>A. Service calls to:</p> <ol style="list-style-type: none"> 1. Correct the installation of your microwave oven. 2. Instruct you how to use your microwave oven. 3. Replace house fuses or correct house wiring. 4. Replace owner-accessible light bulbs. 5. Replace owner-accessible filters. <p>B. Repairs when your microwave oven is used in other than normal, single-family household use.</p> <p>C. Pickup and delivery. Your microwave oven is designed to be repaired in the home.</p> <p>D. Damage to your microwave oven caused by accident, alteration, misuse, abuse, fire, flood, acts of God, improper installation, or use of products not approved by Whirlpool Corporation.</p> <p>E. Any labor costs during limited warranty.</p> <p>F. Repairs to parts or systems resulting from unauthorized modifications made to the appliance.</p>	

10/00

WHIRLPOOL CORPORATION SHALL NOT BE LIABLE FOR INCIDENTAL OR CONSEQUENTIAL DAMAGES. Some states do not allow the exclusion or limitation of incidental or consequential damages, so this exclusion or limitation may not apply to you. This warranty gives you specific legal rights, and you may also have other rights which vary from state to state.

Outside the 50 United States, this warranty does not apply. Contact your authorized Roper dealer to determine if another warranty applies.

If you need service, first see the “Troubleshooting” section of this book. After checking “Troubleshooting,” additional help can be found by checking the “Requesting Assistance or Service” section or by calling our Customer Interaction Center telephone number, **1-800-447-6737**, from anywhere in the U.S.A.