

# Frigidaire Dishwasher

## Use & Care Manual

1000 Series

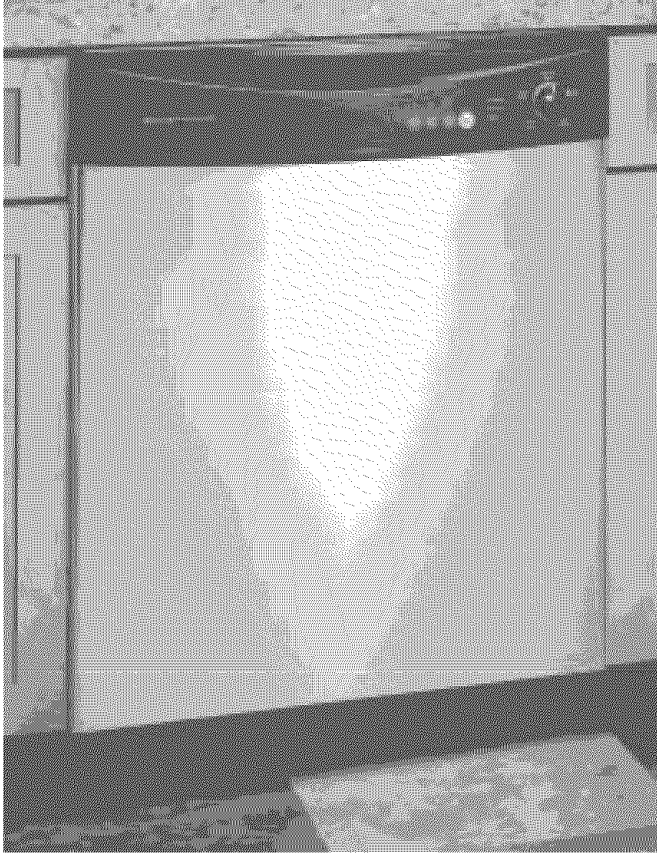

### Record All Information For Future Reference

Brand: \_\_\_\_\_ Purchase Date: \_\_\_\_\_

Model #: \_\_\_\_\_

Serial #: \_\_\_\_\_

(see Features page for location)

**Questions? 1-800-944-9044**

(United States)

**1-800-265-8352**

(Canada)

Visit our Web Site at  
[www.frigidaire.com](http://www.frigidaire.com)

### Product Registration Card

Please fill in completely, sign and return promptly!

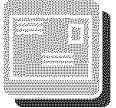

### Safety

Instructions ..... 2

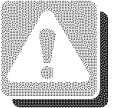

Features ..... 3



### Normal Operating

Sounds ..... 4



### Operating

Instructions ..... 4-6



### Preparing and

Loading Dishes ..... 7-9



### Dishwasher Dispenser

and Detergents ..... 10-11



### Factors Affecting

Performance ..... 11

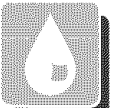

### Care and

Cleaning ..... 12



### Solutions to Common

Dishwashing Problems...13-15

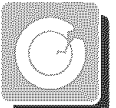

### Consumer Services

Warranty & Service ..... 16

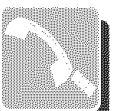

#### Versión en español

Si desea obtener una copia en español de este Manual del Usuario, sírvase escribir a la dirección que se incluye a continuación. Solicite la P/N 154493901, **Spanish Use & Care Manual, Electrolux Major Appliances North America**, P.O. Box 212378, Augusta, GA 30917.

**READ AND SAVE THESE INSTRUCTIONS**

P/N 154544801 (0405)



# Important Safety Instructions

## **⚠ WARNING**

This symbol will help alert you to such dangers as personal injury, burns, fire, and electrical shock.

## **⚠ WARNING**

To reduce the risk of fire, electrical shock, or injury when using your dishwasher, follow basic precautions including the following:

- Read all instructions before using your dishwasher.
- Use your dishwasher only as instructed in this Use and Care Manual.
- This Manual does not cover every possible condition and situation that may occur. Use common sense and caution when installing, operating and maintaining any appliance.
- NSF certified residential dishwashers are not intended for licensed food establishments.
- **DISHWASHER MUST BE ELECTRICALLY GROUNDED.** Read the Installation Instructions for details.
- This dishwasher is designed to operate on regular house current (120 V, 60 Hz). Use a circuit equipped with a 15 ampere fuse or circuit breaker. Use a 20 ampere fuse if dishwasher is connected with a food waste disposer.
- Do not operate dishwasher unless all enclosure panels are in their proper place.
- To avoid entrapment and/or suffocation, remove door or door latch mechanism from any dishwasher that is discarded or not in use.
- Keep young children and infants away from dishwasher when it is operating.
- Do not let children abuse, sit, stand or play on door or racks of a dishwasher.
- Use only detergents and rinse agents recommended for use in a dishwasher.
- Store dishwasher detergent and rinse agents out of the reach of children.
- Do not wash plastic items unless marked “dishwasher safe” or the equivalent. Check with manufacturer for recommendations, if not marked. Items that are not dishwasher safe may melt and create a potential fire hazard.
- If the dishwasher drains into a food disposer, make sure disposer is completely empty before running dishwasher.
- Disconnect electrical power to dishwasher before servicing.
- Repairs should be done by a qualified technician.
- Do not tamper with controls.
- Do not touch the heating element during or immediately after use.
- Use care unloading the dishware when the **SANITIZE** option has been selected. Contents may be hot to the touch immediately after the end of cycle.
- Water vapor from the vent may be hot to the touch when the **SANITIZE** option has been selected. Use care and do not let small children play around or touch the vent area of the dishwasher.
- When loading items to be washed:
  - Locate sharp items and knives so that they are not likely to damage the door seal or tub.
  - Load sharp items and knives with the handles up to reduce the risk of cut-type injuries.
- Under certain conditions, hydrogen gas may be produced in a hot water system that has not been used for 2 weeks or more. **HYDROGEN GAS IS EXPLOSIVE.** If hot water system has not been used for such a period, before using dishwasher, turn on all hot water faucets and let water flow from each for several minutes. This will release any accumulated hydrogen gas. **HYDROGEN GAS IS FLAMMABLE.** Do not smoke or use an open flame during this time.
- Do not store or use combustible materials, gasoline or other flammable vapors and liquids in the vicinity of this or any other appliance.

**SAVE THESE  
INSTRUCTIONS**



# Dishwasher Features

Your dishwasher cleans by spraying a mixture of hot water and detergent through the spray arms against soiled surfaces. Each cycle begins with a pre-drain. Next, the dishwasher fills with water covering the filter area. Water is then pumped through the filter and spray arms. Soil particles go down the drain as the water is pumped out and replaced with clean water. The number of water fills will vary with the cycle being used.

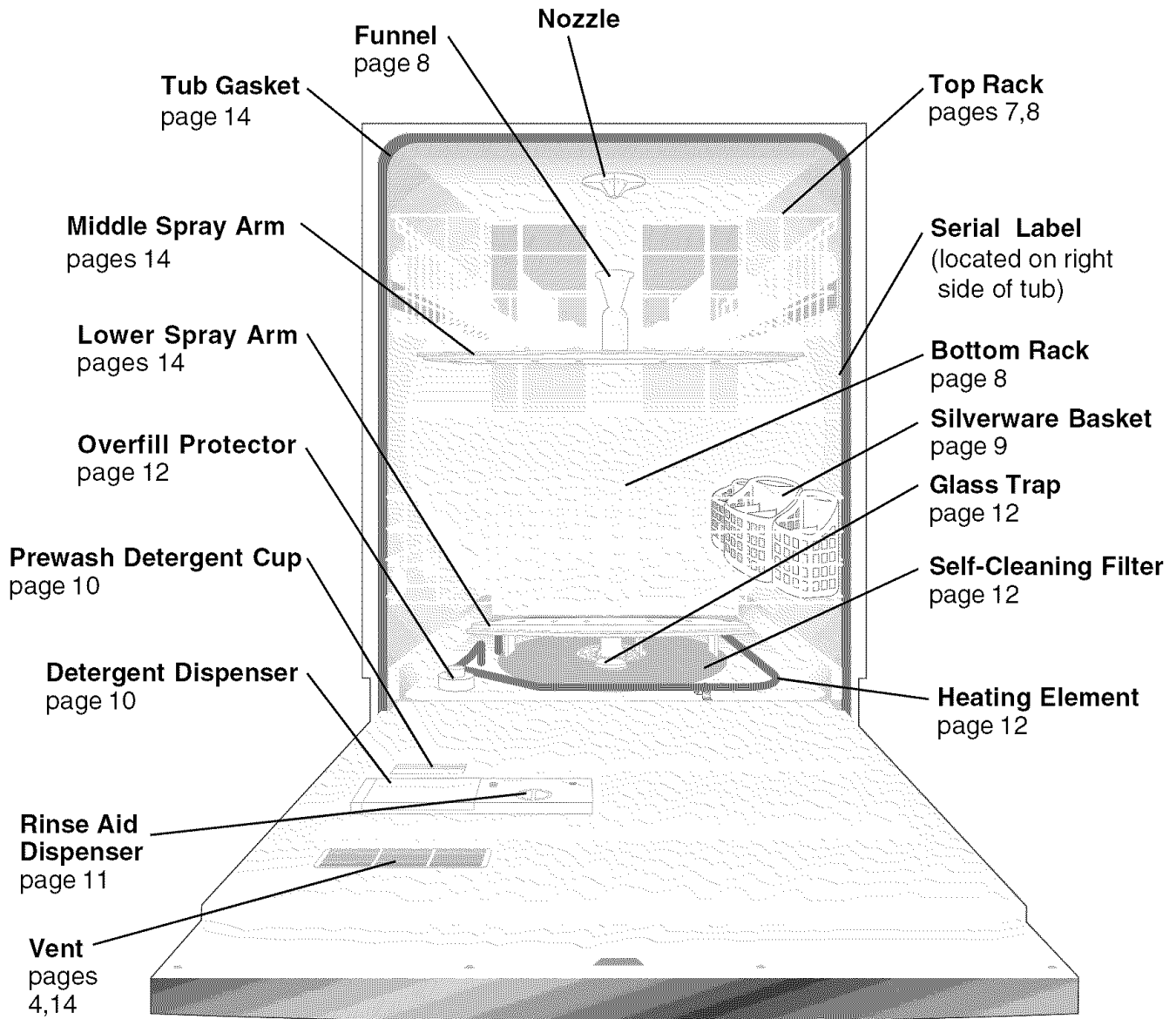

*Appearance may vary from your model.*



# Operating Instructions

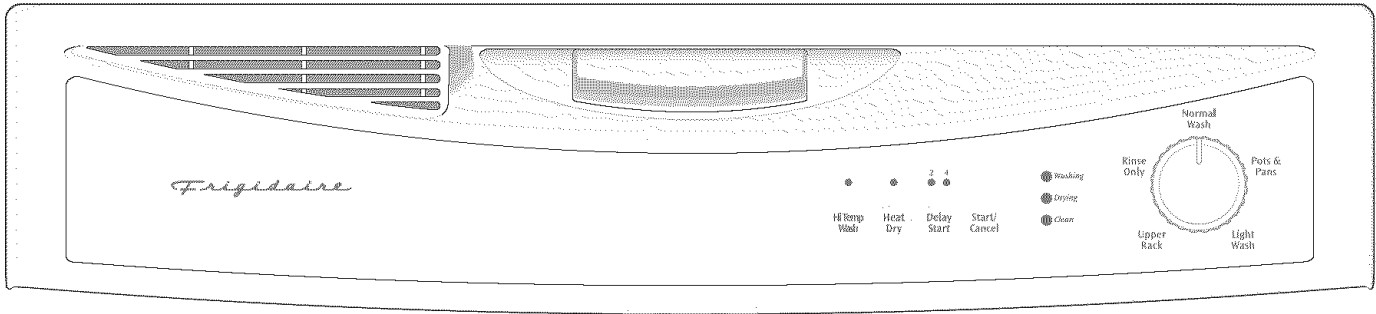

Appearance may vary from your model.

## Very Important Information—Read Before Operating Your Dishwasher!



### Normal Operating Sounds

This dishwasher does not sound like most dishwashers—IT'S QUIETER.

Your Precision Direct Wash System® dishwasher uses energy efficient motors for the wash and drain portions of the cycle you select. Each cycle has a series of water fills and drains for washing and rinsing dishes. As each cycle begins, you may—or may not—hear the drain motor.

The next sound you will hear is the splashing water as it enters the tub. Then the lower arm rotates and circulates water. This is followed by a pause and a slightly different sound as the middle arm sprays water. If you listen closely, you will hear the change in sound as the wash action switches from one arm to the other.

**PLEASE BE ADVISED: If you compare this dishwasher to previous models, you may be surprised at what you DON'T hear!**

## Getting Started

1. Load dishwasher (See Preparing and Loading Dishes).
2. Add detergent (See Dishwasher Dispenser & Detergents).
3. Add rinse aid, if needed (See Rinse Aid).
4. Close door to latch.
5. Select desired CYCLE (See Cycle Chart). The indicator light above the pad will glow when selected.
6. Select desired OPTIONS (See Energy Options). The indicator light above the pad will glow when selected.
7. Run hot water faucet nearest dishwasher until water is hot. Turn water off.
8. To start, press START/CANCEL pad.

## Wash Cycle Selections

**Note:** Cycle times are approximate and will vary with options selected. Hot water is necessary to activate dishwasher detergent and melt fatty food soils. An automatic sensor will check the incoming water temperature and, if it is not hot enough, the timer will be delayed for automatic water heating in the main wash of all cycles. This happens even when HI-TEMP WASH option has not been selected. When HI-TEMP WASH is selected, an even higher temperature will be guaranteed to handle heavier soil loads.



# Operating Instructions (continued)

Cycle Chart				
Cycle	To Select Cycle	Water (approx.)	Time* (minutes)	Washes/Rinses
<b>Pots &amp; Pans</b> For pots, pans, casseroles and dinnerware with dried-on or baked-on soils.	Select POTS & PANS and desired OPTIONS. HI-TEMP WASH will automatically be provided.	8.5 gal. 7.1 imp. gal. 32.2 liters	104	2 washes 5 rinses
<b>Normal Wash</b> For regularly soiled dishes and silverware.	Select NORMAL WASH and desired OPTIONS.	6.1 gal. 5.1 imp. gal. 23.1 liters	89	2 washes 3 rinses
<b>Light Wash</b> For lightly soiled and pre-rinsed dishes and silverware.	Select LIGHT WASH and desired OPTIONS.	4.9 gal. 4.1 imp. gal. 18.6 liters	74	1 wash 3 rinses
<b>Upper Rack</b> For lightly soiled or pre-rinsed dishes and silverware when you do not have a full load.	Select UPPER RACK and desired OPTIONS.	3.7 gal. 3.1 imp. gal. 14.0 liters	65	1 wash 2 rinses
<b>Rinse Only</b> For rinsing dishes that will be washed later.	Select RINSE ONLY. DO NOT USE detergent.	2.4 gal. 2.0 imp. gal. 9.1 liters	18	2 rinses

\* Includes dry time.



# Operating Instructions (continued)

## Options Selections

### Hi-Temp Wash

When HI-TEMP WASH option is selected, the dishwasher heats water in the main wash to approximately 140°F (60°C).

This increase in water temperature helps dishwasher detergent remove food grease and soil from dishes more effectively and aids in drying. HI-TEMP WASH option can be used with all cycles except UPPER RACK and RINSE ONLY. HI-TEMP WASH is automatically provided when POTS & PANS cycle is selected.

When HI-TEMP WASH option is selected, the light above the pad will come on and remain on until end of cycle. To turn off the HI-TEMP WASH option, press the pad a second time. The light above the pad will turn off.

### Heat Dry

The HEAT DRY option in combination with rinse aid will enhance drying performance. The energy required to use the HEAT DRY option costs pennies per cycle. You may choose not to select the HEAT DRY option; however you will have items in your dish load that will not be completely dry at the end of the cycle.

You may see water vapor coming from the vent during the drying portion of cycle. The vent is closed during washing to hold moisture and sound inside. The vent opens during the last few minutes of the final rinse and remains open for drying. The drying option may be changed at any time during the cycle and affects only the drying period.

Opening the door longer than one minute during the dry cycle cancels the selected dry program.

### Delay Start

The DELAY START option allows you to automatically delay starting your dishwasher from 1-3 or 2-4-6 hours depending on your model.

On models with 2-4-6 hour delay, press the pad once for a 2 hour delay, twice for 4 hours and three times for 6 hours. A light will come on indicating the delay start hours and will remain on until cycle starts.

To cancel the DELAY START option and begin the cycle before the delay period is over, press the

START/CANCEL pad.

### To Cancel a Cycle

You can cancel a cycle anytime during the cycle. Press START/CANCEL pad and the dishwasher will start a 90 second drain. At the end of the drain, select the desired cycle.

## Status Indicator Lights

The WASHING light (some models) comes on at the beginning of cycle and remains on until the end of the main wash.

The DRYING light (some models) indicates the drying portion of the cycle. The light will come on when either drying option is selected.

The CLEAN light (some models) will come on at end of cycle and remain on until door is opened.

## Dish Preparation

Scrape away large pieces of food, bones, pits, toothpicks, etc. The continuous filtered wash system will remove remaining food particles. Burned-on foods should be loosened before loading. Empty liquids from glasses and cups.

Foods such as mustard, mayonnaise, vinegar, lemon juice and tomato based products may cause discoloration of stainless steel and plastics if allowed to sit for a long period of time. Unless the dishwasher is to be operated at once, it is best to rinse off these food soils.

- Load racks so that large items do not prevent the detergent dispenser from opening.
- Check manufacturer's recommendations before washing items in question.
- If the dishwasher drains into a food disposer, **be sure disposer is completely empty before starting dishwasher.**

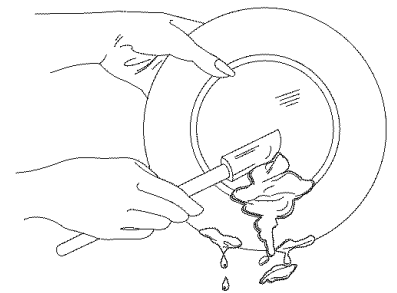

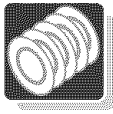

# Preparing and Loading Dishes

## Loading the Top Rack

*Features and appearance of racks and silverware basket may vary from your model.*

**Important: Do not cover the funnel when loading.**

The upper rack is designed for flexibility in loading a wide variety of items including cups, glasses, stemware, small plates, bowls, etc.

Load glasses in top rack. Damage may occur if placed in bottom rack.

Load plastic items in top rack only. Melting may occur if placed in bottom rack.

Load items with open ends facing down for better cleaning and draining.

Damage may occur if delicate items touch each other during dishwasher operation.

Long-handled knives and utensils can be placed in top rack.

Be sure nothing protrudes through the bottom of the rack to block rotation of middle spray arm.

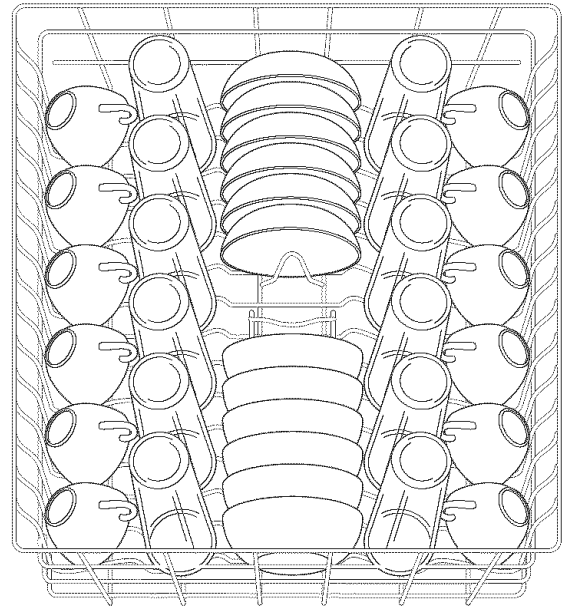

**12 place settings standard loading pattern.**

Some models have a fold-down cup shelf or a cup shelf/stemware holder. They can be used to load two levels of cups, juice glasses, and other short items. Stagger items on upper level so that water can reach all inside surfaces. Fold up to load tall glasses.

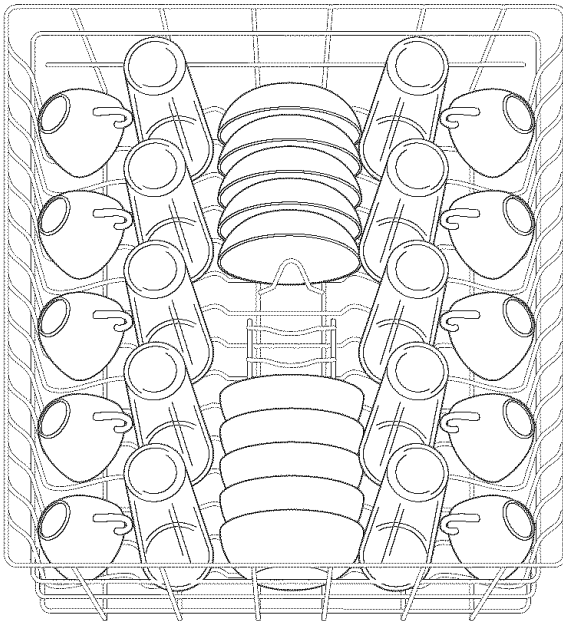

**10 place settings standard loading pattern.**



# Preparing and Loading Dishes (continued)

## Upper Rack Option

The UPPER RACK option can be used to wash a wide assortment of items when you don't have a full load. Also, when the upper rack fills up with glasses and the lower rack is still empty, you don't have to wait anymore for clean glasses.

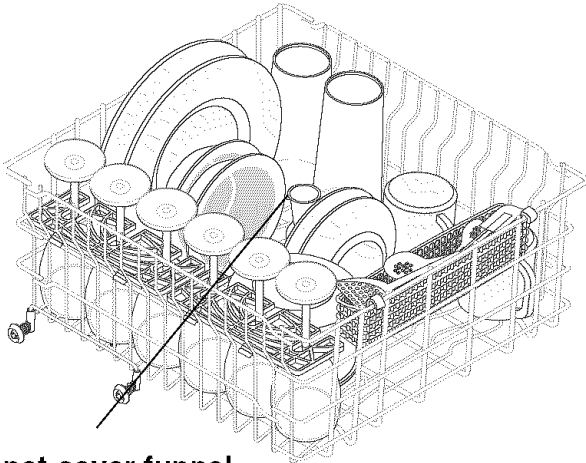

**Do not cover funnel**

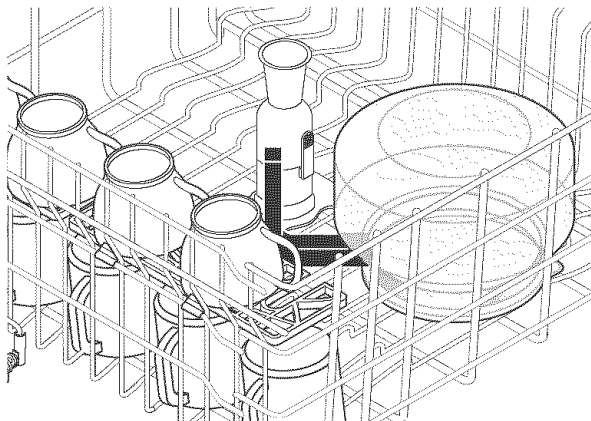
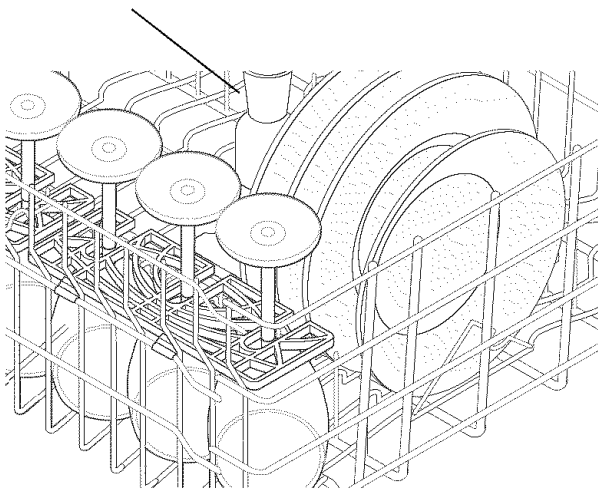

## Loading the Bottom Rack

*Features and appearance of racks and silverware basket may vary from your model.*

The lower rack is best for plates, saucers, bowls, and cookware. Large items should be placed along the edge so they do not block the spray arm rotation. For best results, place bowls, casseroles, and sauce pans with soiled surface facing down or toward the center. Tilt slightly for better drainage.

Make sure tall items do not block spray arm rotation.

Be sure pan handles do not protrude through the bottom of the rack and block the spray arm rotation.

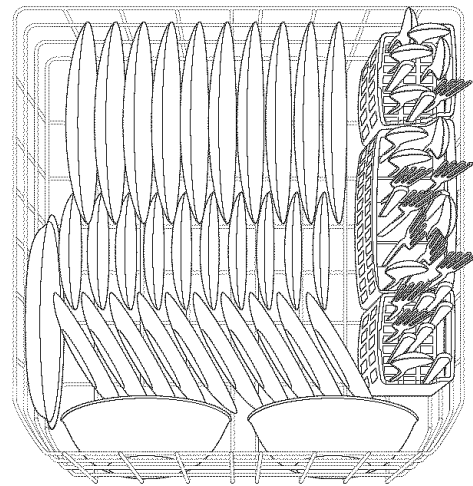

**10 place settings standard loading pattern.**

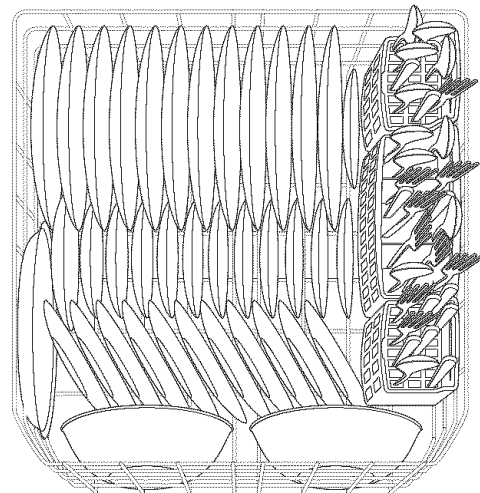

**12 place settings standard loading pattern.**





## Preparing and Loading Dishes (continued)

### Loading the Silverware Basket

#### ⚠ CAUTION

##### Cut Injury

Load sharp items (knives, skewers, etc.) pointing down.

Failure to do so may result in injury.

*Features and appearance of racks and silverware basket may vary from your model.*

Load the silverware basket while it is in the bottom rack or take the basket out for loading on a counter or table.

Place small items like baby bottle caps, jar lids, corn cob holders, etc., in a covered section. Close the cover to hold small items in place.

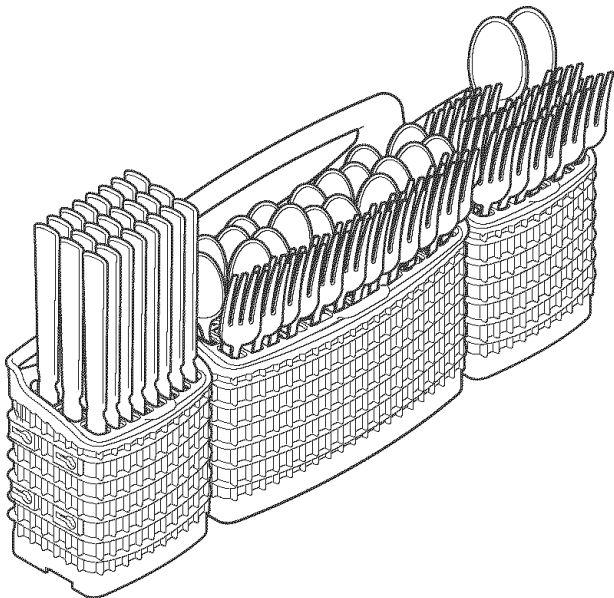

Use suggested loading patterns, as shown, to increase washability of your silverware.

Be sure nothing protrudes through bottom of basket or rack to block the spray arm.

Do not mix silver and stainless to avoid damaging the silver finish.

The silverware basket can be separated and placed in several locations in the bottom rack. Load silverware in all sections or just one, depending on your load.

When covers are up, mix items in each section of the basket with some pointing up and some down to avoid nesting. Water spray cannot reach nested items.

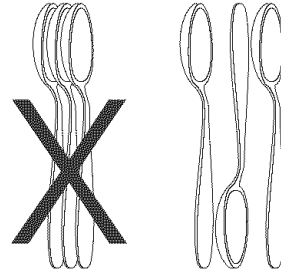

### Adding a Dish

To add or remove items after wash cycle starts:

- Unlatch door and wait a few seconds until wash action stops before opening.
- Add the item and wait a few seconds to allow cold air to slowly expand inside dishwasher.
- Close door firmly to latch and resume cycle.

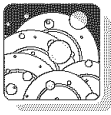

# Dishwasher Dispenser & Detergents

## Filling the Detergent Dispenser

The detergent dispenser has one main wash and one prewash cup. Detergent in the uncovered cup falls into the dishwasher when the door is closed. The covered cup opens automatically to release detergent.

- Use only fresh automatic dishwashing detergent. Other detergents will cause oversudsing.
- When using automatic dishwashing detergent tabs, place one tab in main wash cup and close.
- Add detergent just before starting cycle.
- Store detergent in a cool, dry location. Moist or caked detergent will not dissolve properly.

## How much Detergent to use

The amount of detergent to use depends on the water hardness. Water hardness is measured in grains per gallon. Using too little detergent can result in poor cleaning and hard water filming or spotting. Using too much detergent in soft water can cause a permanent film called etching. Your local water company, water softener company or county extension agent can tell you the water hardness in your area.

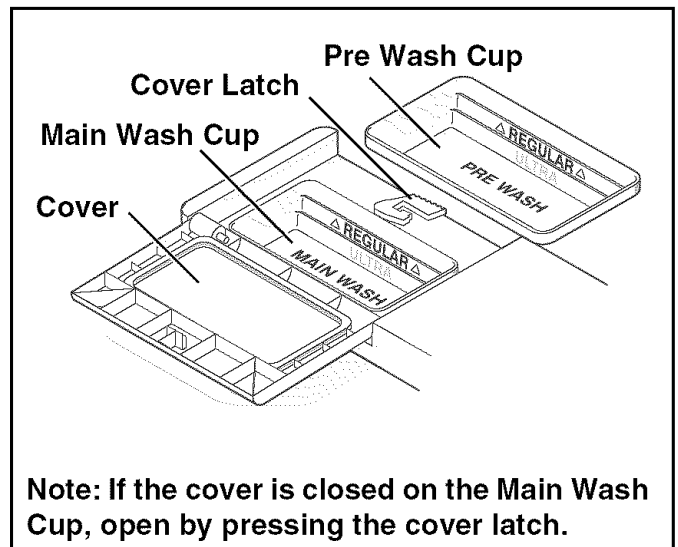

<b>Detergent Usage Guide</b>				
<b>Cycle</b>	<b>Soft Water (0-3 grains)</b>	<b>Medium Hard Water (4-8 grains)</b>	<b>Hard Water (9-12 grains)</b>	<b>Very Hard Water* (over 12 grains)</b>
<b>Pots &amp; Pans or Normal Wash</b>	<b>2 teaspoons</b> (each cup— 1/4 full)	<b>5 teaspoons</b> (each cup—fill to line above "Regular")	<b>8 teaspoons</b> (each cup— completely full)	<b>Each Cup— Completely Full</b> (water softener recommended)
<b>Light Wash or Upper Rack</b>	<b>2 teaspoons</b> (Main Wash cup— 1/4 full)	<b>5 teaspoons</b> (Main Wash cup—fill to line above "Regular")	<b>8 teaspoons</b> (Main Wash cup— completely full)	<b>Main Wash Cup— Completely Full</b> (water softener recommended)
<b>Rinse Only</b>	<b>No Detergent</b>	<b>No Detergent</b>	<b>No Detergent</b>	<b>No Detergent</b> (water softener recommended)

**\*Note:** For very hard water, detergent alone may not be enough. A water softener is recommended to improve water quality and dishwashing performance. Try adding more detergent at the beginning of the main wash portion of the cycle. As a rule, use 1 teaspoon for each grain above 12. Unlatch the door, open slowly and add detergent to the bottom of the tub. Close the door to latch and the dishwasher will continue through the cycle.

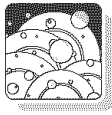

## Dishwasher Dispenser & Detergents (continued)

### Rinse Aid

Rinse aid greatly improves drying and reduces water spots and filming. Water "sheets" off dishes rather than forming water droplets that cling and leave spots.

A dispenser, located next to the detergent cup, automatically releases a measured amount of rinse aid during the last rinse. If spotting and poor drying are problems, increase the amount of rinse aid dispensed by rotating the dial to a higher number. The dial is located under the dispenser cap. The indicator will be dark when full and will show clear when it is time to refill. On models with a STATUS window, LO will appear at the end of the cycle indicating that it is time to refill.

To add liquid rinse aid, turn dispenser cap 1/4 turn counterclockwise and lift out. Pour in rinse aid until liquid touches the indicated fill level. Replace cap.

Do not overfill since this can cause oversudsing. Wipe up any spills with a damp cloth.

The dispenser holds enough for 35 to 140 washes, depending on setting.

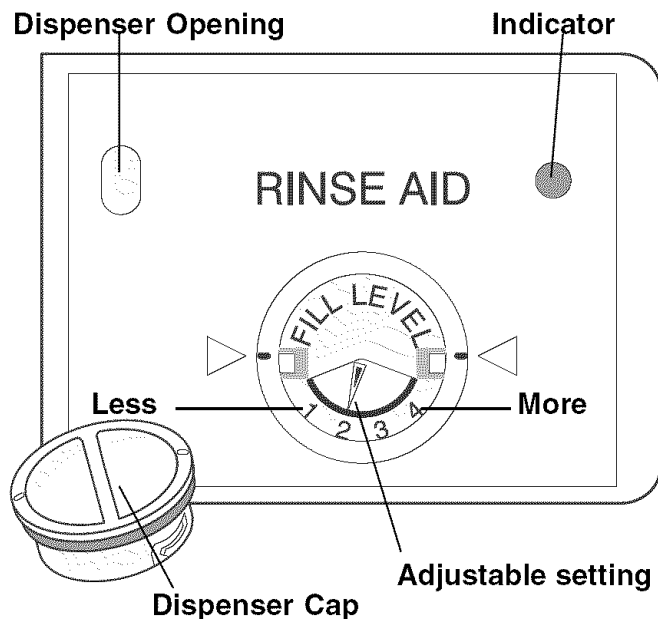

The HEAT DRY option in combination with rinse aid will enhance drying performance. The energy required to use the HEAT DRY option costs pennies per cycle. You may choose not to select the HEAT DRY option; however you will have items in your dish load that will not be completely dry at the end of the cycle.



## Factors Affecting Performance

### Water Pressure

The hot water line to dishwasher must provide water pressure between 20 and 120 psi.

Low water pressure may occur when laundry or showers are in operation. Wait until water use is reduced before starting dishwasher.

### Water Temperature

Hot water is needed for best dishwashing and drying results. Water entering dishwasher should be at least 120°F (49°C) to give satisfactory results.

To check water temperature entering dishwasher:

- Turn on hot water faucet nearest dishwasher for several minutes to clear cool water from pipes.
- Hold a candy or meat thermometer in stream of water to check the temperature.
- If temperature is below 120°F (49°C), have a qualified person raise the hot water heater thermostat setting.

**Important: Before starting a cycle, run hot water to clear cool water from pipe.**



## Care and Cleaning

### ⚠ WARNING

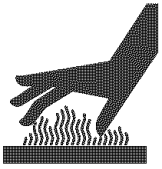

#### Burn Hazard

Allow heating element to cool before cleaning the interior.

Failure to do so can result in burns.

**Outside**—Occasionally wipe with a mild nonabrasive detergent and water. Rinse and dry.

#### Models with Stainless Steel Door—

Clean outer door with warm soapy water and a dishcloth or sponge. Rinse with clean water and a dry cloth. Do not use harsh cleaners.

**Inside**—The inside of the dishwasher is self-cleaning with normal use. If needed, clean around the tub gasket area with a damp cloth.

The filter is self-cleaning. A glass trap located in the center of the filter is designed to collect pieces of broken glass, straws, bones and pits. To remove items in glass trap, grasp handle, lift out, empty and replace.

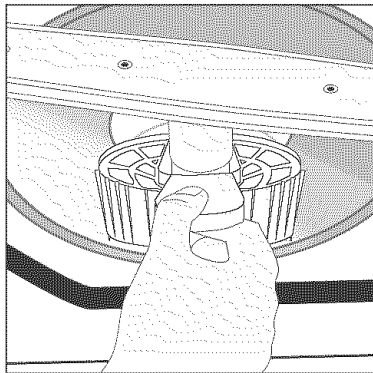

**Note:** Hard water may cause lime deposit buildup on the interior of the dishwasher. For cleaning instructions see “Removing Spots and Film” section.

**Overfill Protector**—keeps dishwasher from overflowing and is located in the left front corner of the tub.

- Clean occasionally with household cleaner containing vinegar or bleach to dissolve any buildup.
- Overfill Protector should move up and down freely about one inch. If it does not move, lift and clean underneath.

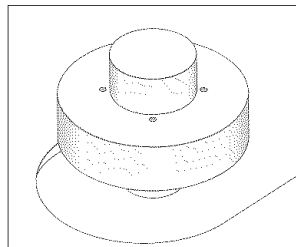

### Care of Drain Air Gap

If a drain air gap was installed for your built-in dishwasher, check to make sure it is clean so the dishwasher will drain properly. A drain air gap is usually mounted on countertop and can be inspected by removing the cover. This is not part of your dishwasher and is not covered by warranty.

### ⚠ CAUTION

#### Property Damage Hazard

Freezing temperatures may cause water lines to rupture. Be sure all supply lines to and circulating lines within dishwasher are protected.

Failure to do so could result in property damage.

### Winterizing

A dishwasher left in an unheated place should be protected from freezing. Have a qualified person do the following:

#### To Disconnect Service:

1. Turn off electrical power to the dishwasher at the supply source by removing fuses or tripping circuit breaker.
2. Shut off water supply.
3. Place a pan under the inlet valve. Disconnect water line from inlet valve and drain into pan.
4. Disconnect drain line from pump and drain water into pan.

**Note:** See Installation Instructions for more details.

#### To Restore Service:

1. Reconnect the water, drain, and electrical power supply.
2. Turn on water and electrical power supply.
3. Fill both detergent cups and run dishwasher through a POTS & PANS cycle.
4. Check connections to make sure they do not leak.

**Note:** See Installation Instructions for more details.



# Solutions to Common Dishwashing Problems

**Before calling for service, review this list. It may save you both time and expense. This list includes common experiences that are not the result of defective workmanship or material in your dishwasher.**

## Food Soils Left on Dishes

- Choose another cycle for longer washing time.
- Check rack loading section for proper loading—avoid nesting items.
- Home water pressure may be too low—should be 20 to 120 pounds per square inch (psi).
- Check incoming water temperature. It should be at least 120°F (49°C). (See Factors Affecting Performance.)
- Check water hardness. For extremely hard water, it may be necessary to install a water softener. (See Detergent Chart.)
- Use fresh detergent.
- Check to make sure funnel in top rack is not blocked.
- Make sure items are not blocking the spray arms, preventing them from rotating.

## Dishes not Dry

- Select heat dry option.
- Make sure the rinse aid dispenser is filled.
- Increase the amount of rinse aid. (See Rinse Aid.)
- Check the incoming water temperature. Be sure it is at least 120°F (49°C).
- Check for proper loading—avoid nesting items.
- Plastic items may need to be towel dried.
- Cups with a concave bottom will collect water.

## Glassware/Flatware Spotted or Cloudy

- Check water hardness. For extremely hard water, it may be necessary to install a water softener. (See Detergent Chart.)
- Water temperature may be low. Avoid extremely low or high temperatures. (See Factors Affecting Performance.)
- Avoid overloading and improper loading. (See Preparing and Loading Dishes.)
- Use fresh detergent. Old detergent is ineffective.
- Make sure rinse aid dispenser is filled.
- Check to see that proper amount of detergent is being used for cycle selected. Also, check phosphate level. (See Detergent Dispenser.)
- Home water pressure may be too low—it should be 20 to 120 pounds per square inch (psi).

## Dishware Chipped

- Load with care and do not overload. (See Preparing and Loading Dishes.)
- Place delicate items in top rack.
- Place glasses securely against pins and not over pins.
- Load items so they are secure and don't jar loose when moving racks in and out. Move racks in and out slowly.
- Make sure tall glasses and stemware will clear top of tub when rack is pushed in.
- Fine antique china and crystal should be hand-washed.

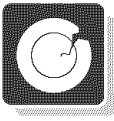

# Solutions to Common Dishwashing Problems

(continued)

## Dishware Stained or Discolored

- Tea and coffee can stain cups. Remove the stains by hand washing in a solution of 1/2 cup (120 ml) bleach and one quart (1 L) of warm water. Rinse thoroughly.
- Iron deposits in water can cause a yellow or brown film. A special filter installed in the water supply line will correct this problem. (See Removing Spots and Film.)
- Aluminum utensils can leave gray/black marks when they rub against other items. Load properly.
- Certain high acid foods can cause discoloration of stainless steel and plastics if allowed to sit for a long period. Use the Rinse & Hold cycle or rinse by hand if not operating dishwasher at once.
- Mixing stainless steel and silver utensils in silverware basket can cause pitting of the stainless steel blades. Avoid mixing stainless steel and silver.

## Etching

- Using too much detergent in soft or softened water causes this film that cannot be removed.
- Adjust the amount of detergent based on the water hardness. (Check Detergent Chart.)
- Lower the water temperature.
- Use no heat dry option.

## Detergent Left in Cups

- Detergent may be old. Discard and use fresh detergent.
- Be sure water action can reach the dispenser.
- Check to see if cycle has been completed.
- Make sure items do not prevent the detergent dispenser from opening.

## Dishwasher Leaks

- Use only fresh detergent designed for automatic dishwashers. Measure detergent carefully. Try a different brand.
- Spilled rinse aid can cause foam and lead to overflowing. Wipe up any spills with a damp cloth.
- Check to see that dishwasher is level. (See Installation Instructions.)

## Normal Sounds You Will Hear

- Normal sounds include water fill, water circulation and motor sounds.
- There is a noticeable change in sound when the wash action switches between the lower and middle spray arm. This is normal since each spray arm has its own sound.
- It is normal for dishwasher to pause (no sound) when the wash action is switching between the lower and middle spray arms.

## Water in Bottom of Tub

- Water left in bottom of tub after cycle is complete is not normal. If water remains in the bottom of the tub, dishwasher may not be draining properly. (See Dishwasher Does Not Drain Properly.)

## Vapor at Vent

- Water vapor escapes from the vent during the drying part of cycle. This is normal.

## Dishwasher Won't Run

- Check to see if circuit breaker is tripped or if a fuse is blown.
- Make sure water supply is turned on.
- Check to see if cycle is set correctly. (See Operating Instructions.)
- Is dishwasher set for delay start option?
- Make sure door is closed and latched.

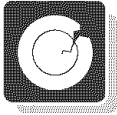

# Solutions to Common Dishwashing Problems

(continued)

## Dishwasher Does Not Drain Properly

- If unit is hooked up to a food waste disposer, make sure the disposer is empty.
- Check to see if the knockout plug has been removed from inside the food waste disposer inlet.
- Check to see if drain hose is kinked.
- Make sure cycle is complete, not in a pause.

## Cycle Takes a Long Time

- Is cycle in a water heating delay?
- Has the delay start option been selected?
- Has the sanitize option been selected?

## Dishwasher Won't Fill

- Is water supply turned on?
- Does overflow protector move up and down freely? (See Overflow Protector section.)

## Dishwasher Has an Odor

- Soiled dishes left in dishwasher too long can create an odor. Use Rinse & Hold cycle.
- There will be a "new" smell when first installed. This is normal.
- Check to see if unit is draining properly. (See Dishwasher Does Not Drain Properly.)

## Stains on Tub Interior

- Washing large amounts of dishware with tomato based soil can cause a pink/orange appearance. This will not affect performance and will gradually fade over time. Pre-rinsing or using the Rinse & Hold cycle will reduce the chance of staining. Using no heat dry option will lessen staining.

## Removing Spots and Film

Hard water can cause lime deposit buildup on the interior of the dishwasher. Dishes and glasses may also get spots and film for a number of reasons. (See Glassware/Flatware Spotted or Cloudy section.) To remove buildup, spots and film, clean using the following instructions:

1. Load clean dishes and glasses in normal manner. Do not load any metal utensils or silverware.
2. Do not add detergent.
3. Select the NORMAL WASH cycle. Close and latch door. Press START/CANCEL pad.
4. Allow dishwasher to run until it starts the second water fill (approximately 10 minutes). The SENSING light will be off.
5. Unlatch and open door and pour 2 cups of white vinegar into the bottom of dishwasher.
6. Close and latch door and allow cycle to finish.

**Note:** If these conditions persist, a home water softener should be considered.

### To customize your dishwasher to match your cabinets:

- You will need a trim kit.
- See Step 10 of Installation Instructions that came with your dishwasher for more information.



# Warranty Information

*Frigidaire*  
Built for Generations

## **DISHWASHER WARRANTY** *Your dishwasher is protected by this warranty*

	WARRANTY PERIOD	THROUGH OUR AUTHORIZED SERVICERS, WE WILL:	THE CONSUMER WILL BE RESPONSIBLE FOR:
<b>FULL ONE-YEAR WARRANTY</b>	One year from original purchase date.	Pay all costs for repairing or replacing any parts of this appliance which prove to be defective in materials or workmanship.	Costs of service calls that are listed under <b>NORMAL RESPONSIBILITIES OF THE CONSUMER.*</b>
<b>EXTENDED LIMITED 2ND YEAR WARRANTY</b>	Two years from original purchase date.	Replace any parts in the Water Distribution System which fail because of a manufacturing defect. This includes the motor, pump, lower wash arm and soft or hard food disposer on all models, plus the wash tower, upper spray arms with associated supply tube, and filter assembly on models including these features. Associated inlet and drain plumbing parts are not covered by this warranty.	Associated inlet and drain plumbing parts. Costs for pickup and delivery of the product required because of service; and all costs for labor and transportation.
<b>EXTENDED LIMITED 2ND - 5TH YEAR WARRANTY</b>	Second through fifth years from original purchase date.	(Electronic Controls, Nylon Racks and TufRacks) For models with electronic controls, replace any electronic control that fails due to a manufacturing defect. For models with nylon-coated racks or TufRacks, replace any original upper or lower nylon-coated rack or TufRack that peels or rusts due to a manufacturing defect.	Costs for pickup and delivery of the product required because of service; and all costs for labor and transportation.
<b>EXTENDED LIMITED 2ND - 10TH YEAR</b>	Second through tenth years from original purchase date.	Provide a replacement tub or door liner if the original tub or door liner fails to contain water because of a manufacturing defect.	Door seals; any costs for pickup and delivery of the product required because of service; and all costs for labor and transportation.
<b>LIMITED WARRANTY (Applicable to the State of Alaska)</b>	Time periods listed above.	All of the provisions of the full warranties above and the exclusions listed below apply.	Costs of the technician's travel to the home and any costs for pick up and delivery of the appliance required because of service.

In the U.S.A. and Canada, your appliance is warranted by Electrolux Major Appliances North America. We authorize no person to change or add to any of our obligations under this warranty. Our obligations for service and parts under this warranty must be performed by us or an authorized Electrolux Major Appliances North America.

### \*NORMAL RESPONSIBILITIES OF THE CONSUMER

**This warranty applies only to products in ordinary household use, and the consumer is responsible for the items listed below:**

1. Proper use of the appliance in accordance with instructions provided with the product.
2. Proper installation by an authorized servicer in accordance with instructions provided with the appliance and in accordance with all local plumbing, electrical and/or gas codes.
3. Proper connection to a grounded power supply of sufficient voltage, replacement of blown fuses, repair of loose connections or defects in house wiring.
4. Expenses for making the appliance accessible for servicing, such as removal of trim, cupboards, shelves, etc., which are not a part of the appliance when it was shipped from the factory.
5. Damages to finish after installation.
6. Replacement of light bulbs and/or fluorescent tubes (on models with these features).

### EXCLUSIONS

**This warranty does not cover the following:**

1. CONSEQUENTIAL OR INCIDENTAL DAMAGES SUCH AS PROPERTY DAMAGE AND INCIDENTAL EXPENSES RESULTING FROM ANY BREACH OF THIS WRITTEN OR ANY IMPLIED WARRANTY.  
*Note: Some states do not allow the exclusion or limitation of incidental or consequential damages, so this limitation or exclusion may not apply to you.*
2. Service calls which do not involve malfunction or defects in workmanship or material, or for appliances not in ordinary household use. The consumer shall pay for such service calls.
3. Damages caused by services performed by persons other than Electrolux Major Appliances North America or their authorized servicers; use of parts other than genuine Electrolux parts; obtained from persons other than such servicers; or external causes such as abuse, misuse, inadequate power supply or acts of God.
4. Products with original serial numbers that have been removed or altered and cannot be readily determined.

### IF YOU NEED SERVICE

Keep your bill of sale, delivery slip, or some other appropriate payment record. The date on the bill establishes the warranty period should service be required. If service is performed, it is in your best interest to obtain and keep all receipts. This written warranty gives you specific legal rights. You may also have other rights that vary from state to state. Service under this warranty must be obtained by contacting Electrolux Major Appliances North America

This warranty only applies in the 50 states of the U.S.A. and Puerto Rico, and Canada. Product features or specifications as described or illustrated are subject to change without notice. All warranties are made by Electrolux Major Appliances North America.

05-U-DW-01(Rev. 01/2002)

**USA 800•944•9044**  
Electrolux Major Appliances North America  
a division of Electrolux Home Products, Inc.  
P.O. Box 212378  
Augusta, GA 30917

**Canada 800•265•8352**  
Electrolux Major Appliances North America  
a division of Electrolux Home Products, Inc.  
5855 Terry Fox Way  
Mississauga, Ontario L5V 3E4