



KitchenAid®

SPECIAL EDITION

BUILT-IN DISHWASHER

MODEL KDB-21SE

USE & CARE GUIDE

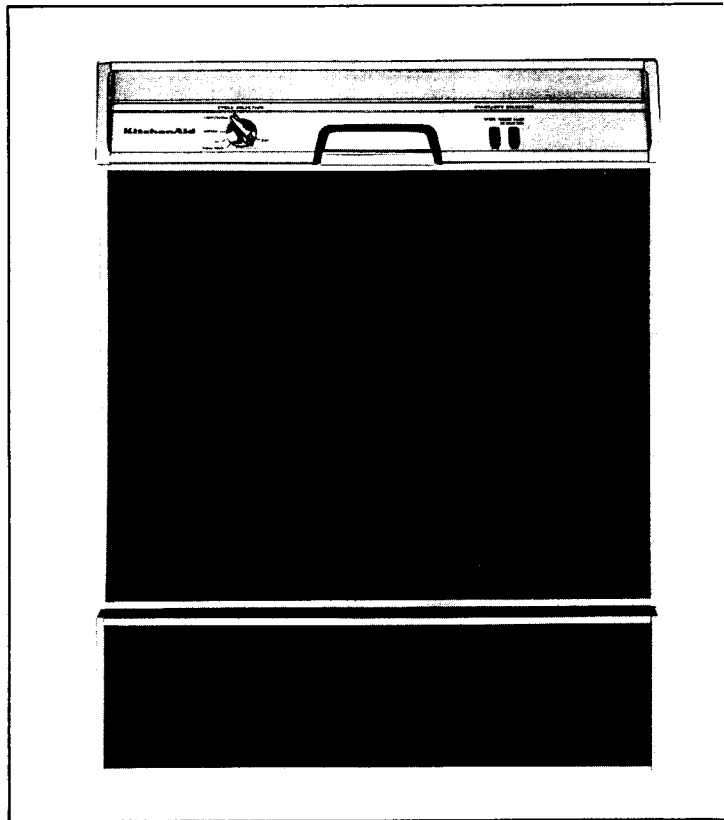

4177729



TABLE OF CONTENTS

	Page
Important Safety Instructions.....	4
Ownership Registration Card.....	5
Important Facts	5
Get To Know Your Dishwasher.....	6
Operating Your Dishwasher	7
Sounds You May Hear	7
Energy Saving Tips	9
Dishwasher Cycles	10
To Cancel A Cycle.....	11
Adding Dishware During A Cycle.....	11
Special Tips On Dishwasher Use	12
Loading Your Dishwasher	13
Upper Rack	13
Lower Rack	14
Silverware Basket	15
Filling The Detergent Dispenser.....	16
How Much Detergent To Use.....	17
Low Phosphate Detergents.....	17
Rinse Agents	17
Caring For Your Dishwasher	18
Seasonal Storage.....	18
Sure-Clean Wash System	20-21
Problems, Cause, Solution Chart	22-23
To Remove Spots And Film	23
Changing Front Panels	24-26
Optional Front Panels.....	26
When You Need Service	27
Warranty	Back Cover

IMPORTANT SAFETY INSTRUCTIONS

WARNING: When using your dishwasher, follow basic precautions, including the following:

1. Read all instructions before using the dishwasher.
2. This dishwasher must be properly grounded; see Installation Instructions for details.
3. Use the dishwasher only for its intended function.
4. Use only detergents or wetting agents recommended for use in a dishwasher, and keep them out of the reach of children.
5. When loading items to be washed:
 - a. Locate sharp items so that they are not likely to damage the door seal.
 - b. Load sharp knives with the handles up to reduce risk of cut-type injuries.
6. Do not wash plastic items unless marked "dishwasher safe" or the equivalent. For plastic items not so marked, check the manufacturers' recommendations.
7. Do not touch the heating element during or immediately after use.
8. Do not operate your dishwasher unless all enclosure panels are properly in place.
9. Do not tamper with controls.
10. Do not abuse, sit on or stand on the door or dish rack of the dishwasher.
11. To reduce the risk of injury, do not allow children to play in or on a dishwasher.
12. Under certain conditions, hydrogen gas may be produced in a hot water system that has not been used for two weeks or more. *Hydrogen gas is explosive.* If the hot water system has not been used for such a period, turn on all hot water faucets and let the water flow from each for several minutes. This will release any accumulated hydrogen gas. Since the gas is flammable, do not smoke or use an open flame during this process.
13. Remove the door to the washing compartment when removing an old dishwasher from service or discarding it.

SAVE THESE INSTRUCTIONS



OWNERSHIP REGISTRATION CARD

Take a minute...

Before you use your dishwasher, please fill out and mail your ownership registration card packed with the Use and Care Guide. This card will enable us to contact you in the unlikely event of a product safety notification and assist us in complying with the provisions of the Consumer Product Safety Act. **THIS CARD DOES NOT VERIFY YOUR WARRANTY.**

Keep a copy of the sales receipt showing the date of purchase and/or date of installation of your dishwasher. **PROOF OF PURCHASE WILL INSURE YOU OF IN-WARRANTY SERVICE.**

Write down the following information. You will need it if your dishwasher ever requires service.

Model Number* _____

Serial Number* _____

Date Purchased _____

Date Installed _____

Dealer's Name _____

Address _____

Phone _____

*Model and Serial Numbers are located on a label at the left side of the door opening.

IMPORTANT FACTS

You Should Know That...

- KitchenAid dishwashers operate on 115 volts, 60 hertz A.C. house current. They *cannot* be converted to operate on 220 volts, 50 hertz house current.
- To protect against possible rupture of fill valve, **BE SURE** water lines leading to the dishwasher as well as water lines in the dishwasher are protected against freezing. Such ruptures are *not* covered by the warranty.
- The door hinges or latch mechanism of your dishwasher should be removed if you discard or otherwise remove your dishwasher from service. In California, it is a misdemeanor for anyone discarding the appliance not to follow this safety procedure. This extra step can save the lives of curious children at play.



GET TO KNOW YOUR DISHWASHER

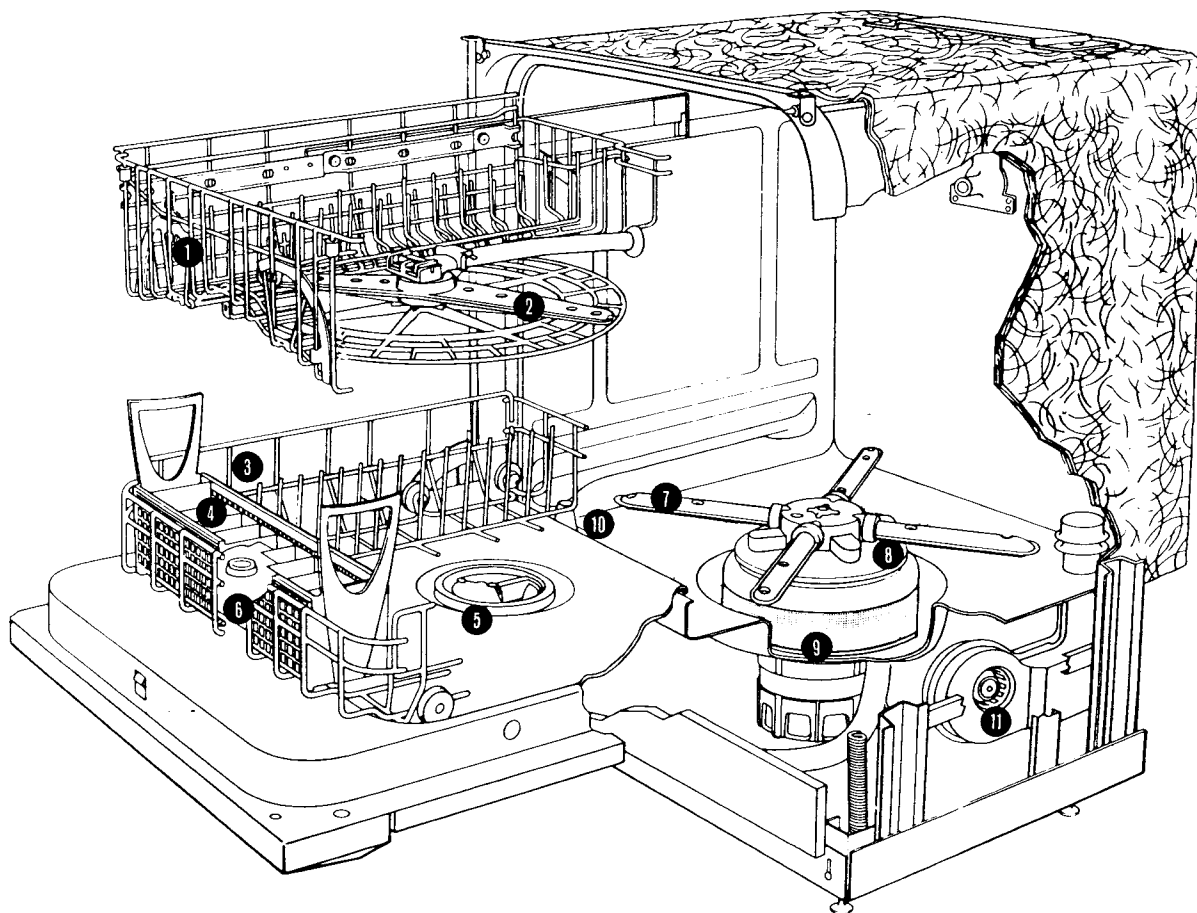

The Inside Story

- | | |
|---|--|
| 1. Stay-Put Flex-O-Dividers | 7. 4-Way Hydro Sweep Wash |
| 2. Upper Level Power Wash with
China Guard | 8. Self-Cleaning Filter with Jet Spray |
| 3. Lower Rack | 9. Removable Coarse Strainer |
| 4. Cutlery/Silverware Basket | 10. Overflow Protection Float |
| 5. Detergent Dispenser | 11. Flo-thru Drying Fan |
| 6. Automatic Rinse Agent Dispenser | |





OPERATING YOUR DISHWASHER

Step 1... Load dishes into racks according to instructions on pages 13 and 14. **DO NOT OPERATE DISHWASHER WITHOUT RACKS IN PLACE.**

Step 2... Add detergent to detergent dispenser. See page 16.

Step 3... Firmly close the door and latch it by pushing the door handle down.

Step 4... Advance Cycle Selection Dial slowly to corresponding cycle. See page 10 for description of cycles.

Step 5... Push Start Button.

Sounds You May Hear While Your Dishwasher is Running:

- the fill valve opening or closing and the sound of water entering the dishwasher
- water being pumped out during drain portion of cycle
- detergent cup opening
- timer clicking as it advances or resets
- pump motor starting



TO CHECK YOUR WATER TEMPERATURE

For best dishwashing results, water should be at least 140°F (60°C) as it enters the dishwasher. To check the temperature, use the faucet closest to your dishwasher.

1. Set the faucet control for the hottest water possible. Run water into a glass set in the sink for at least one minute, allowing it to overflow.
2. Place a candy or meat thermometer in the glass and read it at the maximum setting.
3. If the temperature is too low, raise the setting on your water heater.



ENERGY SAVING TIPS

Power to Spare...

- Use the ENERGY SAVER-NO HEAT DRY option whenever possible. If you don't need your dishes right away, it pays to air dry them.
- Flash dry dishes. After final rinse, unlatch door and advance Cycle Selection Dial to Normal Cycle; open door and pull out racks. Because of the heat buildup in dishware during the wash cycle, water evaporates quickly from the dishware.

NOTE: In hard water areas, flash drying can increase the likelihood of spotting and filming.

- Run the dishwasher only with a full load.
- Do not rinse dishware before loading.
- Use only the cycle and options that you need.
- Run the dishwasher at night during the summer to avoid daytime heat load.

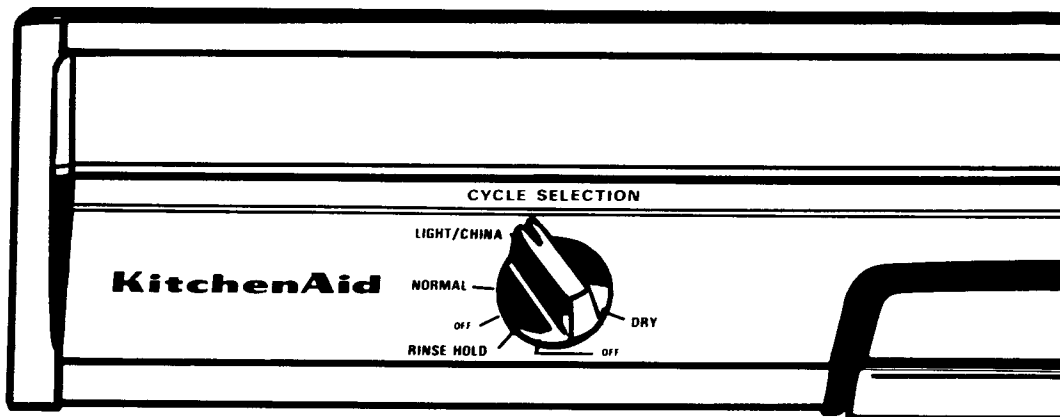

SELECT A WASH CYCLE

LIGHT/CHINA WASH CYCLE is used to wash and dry daily loads with light amounts of food soil. This cycle uses less water and time than the Normal Wash Cycle and is the most efficient cycle to use.

What happens during this cycle?

There are two wash periods with one final after rinse followed by a heated dry period.

NORMAL WASH CYCLE is used to wash and dry daily loads with light amounts of food soil.

What happens during this cycle?

There are two wash periods each with an after rinse followed by a heated dry period.

What happens during this cycle?

There are three wash periods with two after rinses followed by a heated dry period.

NOTE: All cycles may be used to wash and dry dishwasher-safe china and crystal. Check manufacturers' recommendation before washing.

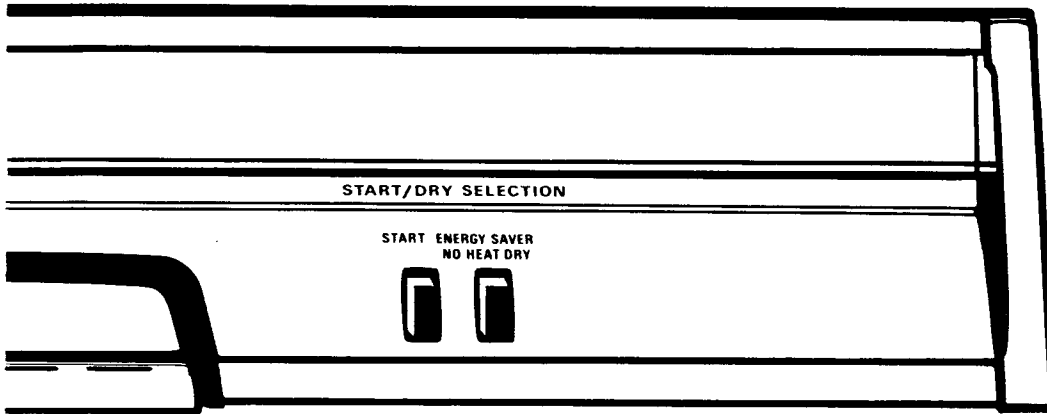

RINSE/DRY SELECTIONS

RINSE & HOLD CYCLE is used to rinse partial loads of dishes until a full load is accumulated. No detergent is used. Dishware is kept moist until a complete wash and dry cycle can be run.

What happens during this cycle? This cycle provides one rinse.

ENERGY SAVER—NO HEAT DRY can be used with any Wash Selection to eliminate the heat during the dry portion of a cycle. The fan of the drying system will continue to operate, helping the dishes to air dry naturally. Under certain conditions, you may find a few drops of water on the dishware and silverware at the end of this cycle.

TO CANCEL A CYCLE

The Cycle Selection Dial may be used to cancel any cycle in progress. If water is present in the dishwasher, turn the dial slowly to the drain portion of the wash or rinse. You will hear water draining when you have advanced to the proper location. Let the dishwasher drain completely. Lift the

door handle and advance the dial to the Normal Cycle. This cancels the cycle.

If water is absent from the dishwasher, lift door handle to stop dishwasher action. Relatch door and advance dial to Normal Cycle. This cancels the cycle.

TO START A NEW CYCLE—Open dishwasher; check detergent dispenser to be sure it is properly filled. Close and latch door; select the desired new cycle and press start.

ADDING DISHWARE DURING A CYCLE

You can add a forgotten item to the dishwasher anytime before the main detergent wash portion of the cycle. To stop the cycle, just unlatch the door handle. However, opening the door during a cycle reduces the cleaning power, so try to load all items before starting the cycle.

TO RESTART DISHWASHER

Close the door and latch the handle, push the start button and if desired, the Energy Saver button. The cycle will start exactly where it was stopped.

SPECIAL TIPS ON DISHWASHER USE

What Can and Cannot Be Washed in Your Dishwasher

Most tableware, cookware and silverware can be safely washed in your KitchenAid dishwasher. If you have any doubts about a particular piece of dishware, check with the manufacturer to see if it is dishwasher safe. If you cannot reach the manufacturer, simply test-wash a small item for several weeks before attempting to wash an entire set.

REMEMBER: It is the user's responsibility to determine if dishware should be washed in a dishwasher.

Material	Dishwasher Safe?	Exceptions/ Special Information	Material	Dishwasher Safe?	Exceptions/ Special Information
Aluminum	Yes	High water temperature and detergents may affect finish of anodized aluminum.	Pewter	No	High water temperatures and detergent may discolor or pit finish.
Cast Iron	No	Seasoning will be removed, and iron will rust.	Disposable Plastics	No	Cannot withstand high water temperatures and detergents.
China/ Stoneware	Yes	Always check manufacturers' recommendation before washing. Antique, hand-painted or over-the-glaze patterns may fade. Gold leaf may discolor. If in doubt, test-wash a small item for several weeks before washing an entire set.	Plastics	Yes	Always check manufacturers' recommendation before washing. Plastics vary in their capacity to withstand high water temperatures and detergents.
Crystal	Yes	Always check manufacturers' recommendation before washing. Some types of leaded crystal may etch with repeated washings. If in doubt, test-wash a small item for several weeks before washing an entire set.	Stainless Steel	Yes	Run a RINSE & HOLD CYCLE if not washing immediately. Prolonged contact with foods containing salt, vinegar, milk products or fruit juice could damage finish.
Dirilyte	No	Gold-colored flatware will discolor.	Sterling Silver or Silverplate	Yes	Run a RINSE & HOLD CYCLE if not washing immediately. Prolonged contact with food containing salt, acid or sulfide (eggs, mayonnaise and seafood) could damage finish.
Glass	Yes	Milk glass will yellow with repeated dishwasher washing.	Tin	No	May rust.
Hollow-Handle Knives	No	Handles of some knives are attached to the blade with adhesives which may loosen if dishwasher washed.	Wooden Ware	No	Always check manufacturers' recommendation before washing. Untreated wood may warp, crack or lose its finish.

LOADING YOUR DISHWASHER

Your KitchenAid dishwasher is designed with lots of loading space. Glasses, mugs, saucers and saucepans can be loaded in either the upper or lower rack. For best results, dishware should be loaded so soiled surfaces face the rotating wash arm.

No hand rinsing is necessary before loading your KitchenAid dishwasher. *Just scrape* leftover food, bones, toothpicks and other hard items from the dishware.

Some foods like eggs, rice, pasta and cooked cereals may be hard to remove if left to dry over a period of time. If you do not plan to wash your dishes immediately after use, run a RINSE & HOLD CYCLE to keep them moist until you are ready to run the next wash cycle. Never prewash dishes with a hand dishwashing detergent. It will cause sudsing in the dishwasher and result in poor cleaning and/or spotting and filming on the dishware.

FLEX-O-DIVIDERS

A pair of movable dividers are located on either side of the fixed center row pins. Each divider works independently of the other and can be changed to fit loading needs. To adjust, place thumb and index fingers on pins and squeeze towards each other. Secure pin into selected notch or fold down flat. The outside row folds towards the outside of the rack, and the inside row folds towards the center pins.

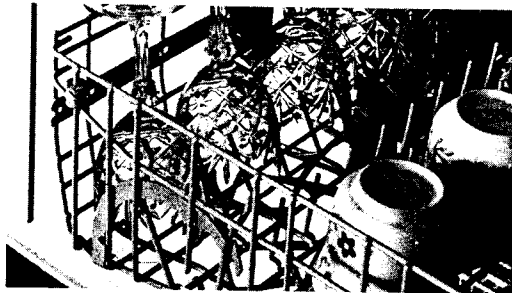

UPPER RACK LOADING EXAMPLES

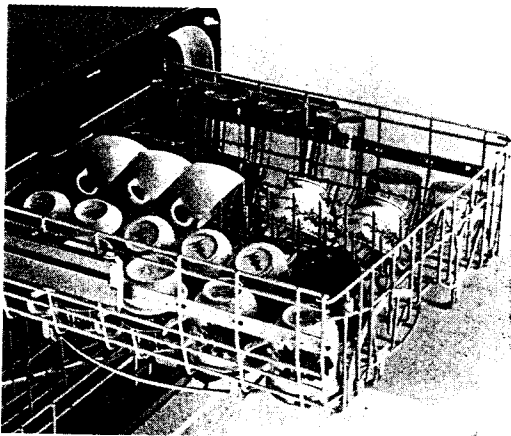

- Load coffee cups and mugs in positions illustrated to insure proper drainage. Tilt cups and mugs with concave bottom surfaces to aid drainage.

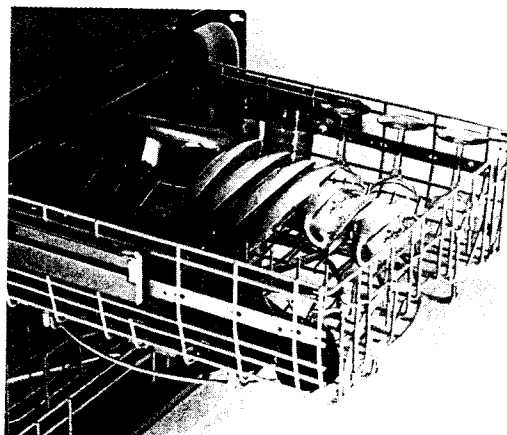

- Lightweight plastics, or glassware and stemware should be locked into place using the outside row of flex-o-dividers. Additional glasses, cups, bowls, saucers and pans, may also be loaded in the upper rack between and over pins in a stable manner.

LOADING YOUR DISHWASHER

LOWER RACK LOADING EXAMPLES

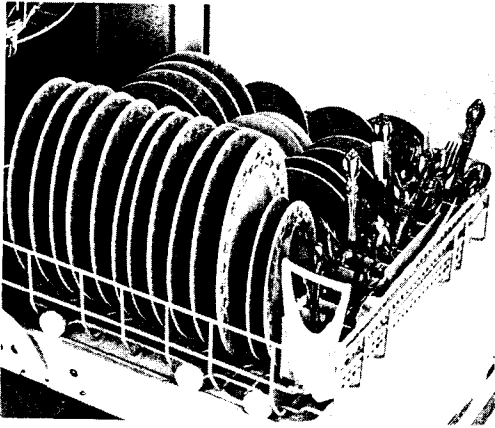

- For maximum capacity and stability of an all-plate load, overlap or "butterfly" small plates on right side, as shown.

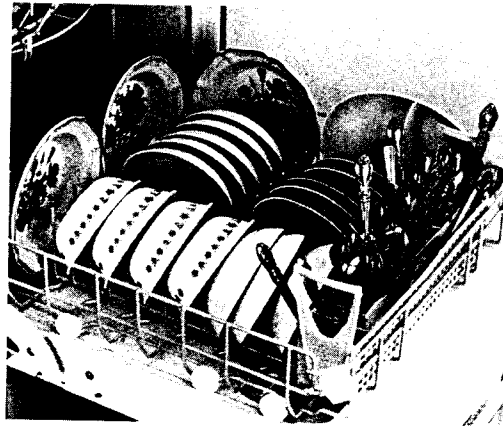

- Cereal/soup bowls may be loaded in a variety of ways, depending upon the shape of the bowls.

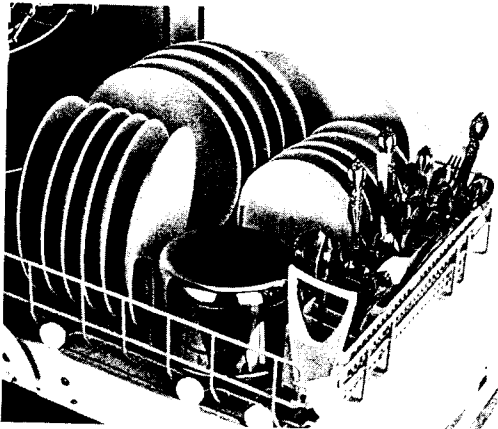

- Plates may be loaded front to back or side to side with pots, pans and large cookware.

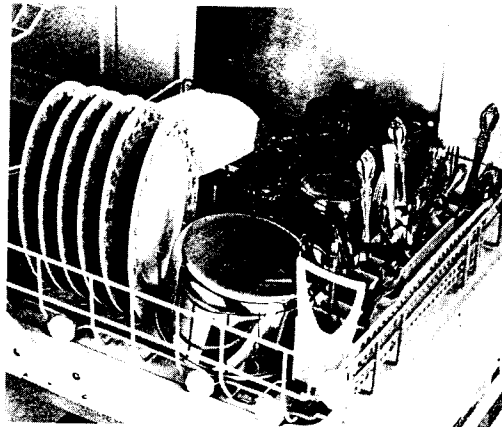

- Glasses may be loaded in the upper or lower rack along with plates, bowls and saucepans.

SILVERWARE BASKET

The silverware/cutlery basket can be removed for loading and unloading.

For best washing results:

- Load slim handled silverware with handles up to prevent them from sticking out through the basket, possibly causing damage to the silverware or dishwasher.

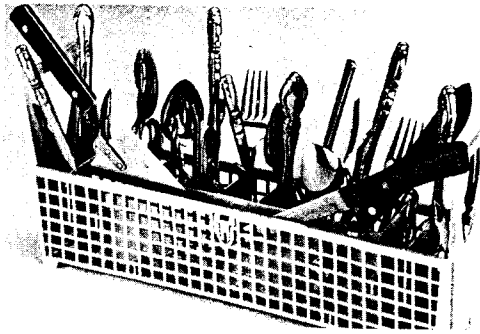

- Sharp utensils should be loaded with handles up to prevent possible injury.
- The cutlery section in the front of the basket is for long-handled utensils and long knives.

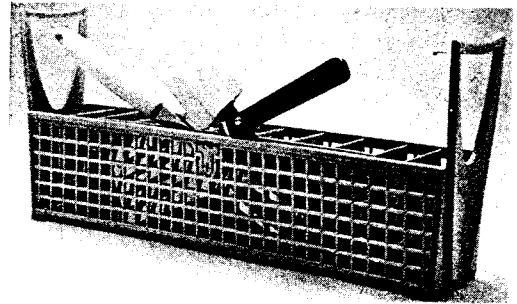

- Load forks and spoons with handles up and down so they do not nest together. Nested items cannot be properly washed.

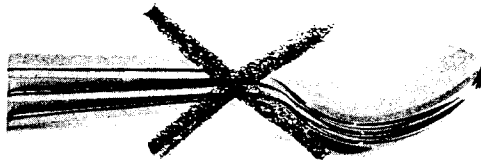

NOTE: Silver and stainless steel flatware may be damaged if exposed to foods containing salt, vinegar, milk products or fruit juices for long periods of time. Use the RINSE & HOLD CYCLE if flatware is not washed immediately after use.



FILLING THE DETERGENT DISPENSER

Low Suds Mean High Performance

1. Use an automatic dishwasher detergent such as ALL, CASCADE, ELECTRASOL or FINISH. Never use soap, hand dishwashing detergent, laundry detergent or laundry enzyme products. They will produce excessive suds and slow down the wash arm action which could cause flooding.
2. Add detergent to the dispenser immediately before starting. Detergent exposed to moisture over a period of time may become caked and ineffective. An open box of detergent should stay fresh for about one month.
3. Fill the dispenser with the proper amount of detergent, and close the compartment.

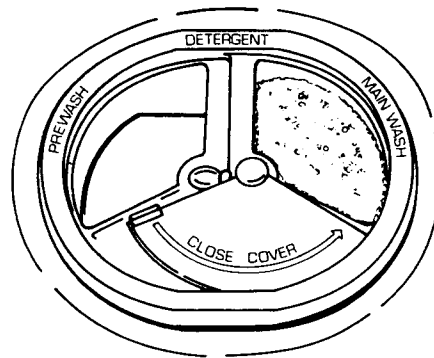

Fill the Main Wash compartment for the Light/China Wash Cycle when the dinnerware is lightly soiled.

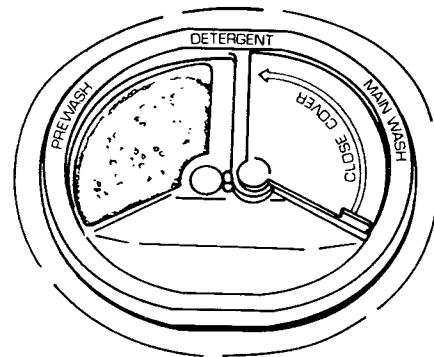

Fill both the Prewash and Main Wash compartments for the Light/China Wash Cycle and the Normal Wash Cycle.

HOW MUCH DETERGENT TO USE

Some Hard Facts:

ALWAYS use at least one tablespoon of automatic dishwashing detergent in Main Wash compartment because there are ingredients in detergent to help protect your dinnerware. The amount of detergent needed depends on the amount of food soil on the dishes and the hardness of water. If you have hard water, you will have to use more detergent than if you have soft water. Excessive amounts of detergent combined with soft water may cause etching of glass.

Contact your local water utility, area water softening company or state university extension agent to determine whether your water is hard or soft.

WATER HARDNESS	AMOUNT OF DETERGENT
Soft Water 0-4 grains per gallon	Fill each dispenser half full (approximately 2 tablespoons per dispenser)
Medium Hard Water 4-8 grains per gallon	Fill each dispenser $\frac{3}{4}$ full (approximately 2½ tablespoons per dispenser)
Hard Water 8-12 grains per gallon	Fill each dispenser completely (approximately 3 tablespoons per dispenser)

LOW PHOSPHATE DETERGENTS

If you live in a state that mandates low-phosphate dishwasher detergents (phosphate content of 8.7 percent or less), you may have to use more detergent, particularly if you have hard water. Low-phosphate detergents usually work well in soft water, but in hard water they can cause spotting and filming, even if the amount of detergent used is increased.

RINSE AGENTS

Win The War Against Spotting

Your dishwasher uses a liquid rinse agent. A rinse agent helps water to sheet off dishware faster than normal, reducing water spots and speeding up the drying process.

To fill the rinse agent dispenser, unscrew the cap located to the left of the detergent dispenser. This reservoir will hold 7 fluid ounces of rinse agent, enough to last a few months. Be sure to replace the cap after filling the reservoir. A small amount of rinse agent is automatically released during the final rinse. Liquid rinse agents such as JET DRY are available in your local supermarket.

WARNING: DISHWASHER DETERGENTS AND RINSE AGENTS CAN BE HARMFUL IF TAKEN INTERNALLY. FOR SAFETY'S SAKE, PLEASE STORE THESE PRODUCTS OUT OF CHILDREN'S REACH.

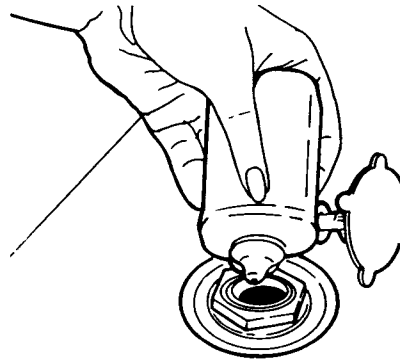



CARING FOR YOUR DISHWASHER

A Clean Machine...

General Cleaning

The porcelain enamel interior of your dishwasher will seldom need cleaning. However, if mineral deposits from hard water accumulate, clean the interior with a mild scouring powder such as BON AMI, or follow the suggestions indicated in the "To Remove Spots and Film" section on page 23.

The control panel can be wiped clean with a damp cloth, then dried. NEVER use detergents or abrasive or powdered cleansers which can mar the finish.

The enamel or wood fronts and sides can be cleaned with a soft cloth and a mild, non-abrasive soap and water solution. NEVER use paper towels for cleaning. Always dry with a soft cloth.

SEASONAL STORAGE

Closed for the Season

The Summer Season:

Two simple steps will safeguard your KitchenAid dishwasher during an idle summer:

1. Turn off the water supply.
2. Turn off electricity to the dishwasher.

The Winter Season:

CAUTION: To protect against possible rupture of fill valve. BE SURE water lines leading to, as well as in the dishwasher, are well protected against freezing. RUPTURES OF THIS KIND ARE NOT COVERED BY THE WARRANTY.

To safeguard your KitchenAid dishwasher when it is exposed to freezing temperatures in a seasonal dwelling, have your local KitchenAid service person do the following:

1. Close and latch the door.
2. Turn off electricity to the dishwasher.
3. Shut off water supply. Place pan under fill valve, and disconnect fill valve at both inlet and outlet sides. Drain water into pan.
4. Place a pan under the check valve outlet, and disconnect the flexible tubing at the check valve. Drain machine water into pan. Leave fill and check valve disconnected.

To restore service, reconnect the fill valve and the connection at the check valve. Turn on the electricity and the water supply. Close and latch the door. Select the LIGHT/CHINA WASH CYCLE and let the machine complete its cycle. Check connections to make sure they are water tight and do not leak.



Drain Air Gap

Some state or local plumbing codes require the addition of a drain air gap between a built-in dishwasher and the home drain system. This device protects your dishwasher against water backing up into it when a drain clogs. The drain air gap is usually located on top of the sink or countertop near the dishwasher.

REMEMBER: This external plumbing device is not part of your KitchenAid Dishwasher.

To clean the drain air gap:

Clean the drain air gap periodically to insure proper drainage of your dishwasher. Follow drain air gap cleaning instructions provided by the manufacturer. With most types, just lift off the chrome cover, unscrew the plastic cap, and then check for any buildup of soil. Clean, if necessary.

Check the Air Gap Anytime Your Dishwasher Isn't Draining Well.

REMEMBER: The warranty provided with your dishwasher does not cover service costs directly associated with the cleaning or repair of the external drain air gap.

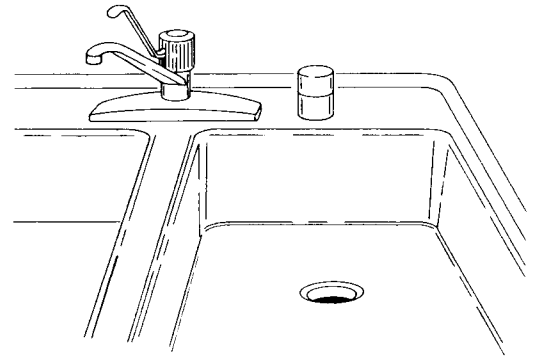



SURE-CLEAN WASH SYSTEM

The Sure-Clean Wash System in your dishwasher provides the best washability with a minimum of care. The wash water is continuously filtered by a triple filtration and soil collector system to prevent food particles

spray action of water from the single spray nozzle (D) underneath the wash arm. The ultrafine filter is cleaned by the nine water jets (E) underneath the 4-Way Hydro Sweep Wash Arm.

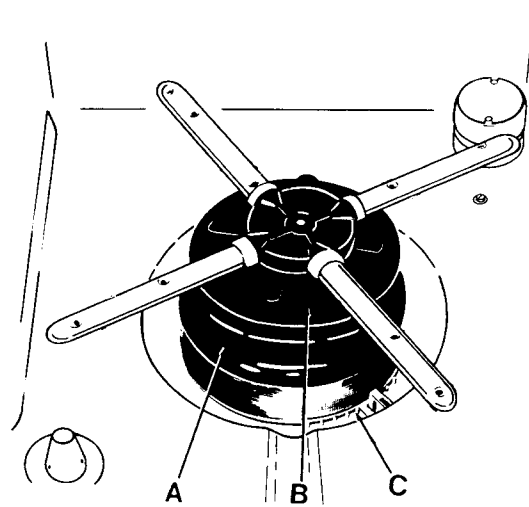

from redepositing on clean dishes. The triple filtration system consists of a removable filter (A), an ultrafine filter (B) and a removable coarse strainer (C).

The removable filter continuously filters the wash water and traps the food particles that have been removed from the dishes on the outside of the filter. These trapped food particles are removed from the filter by the jet

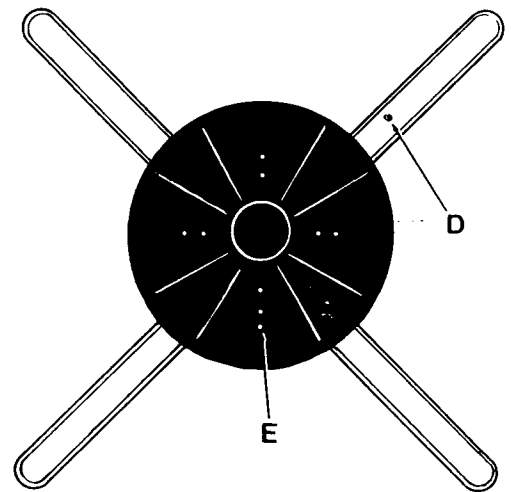

The removable coarse strainer (C) prevents bones, pits and other large objects from entering the pump system. Occasionally check the strainer for such items that may have mistakenly gotten into the dishwasher.



The 4-Way Hydro Sweep Wash Arm, the removable filter and the coarse strainer may be removed and cleaned if necessary. If food soils remain on the removable filter, lift the 4-Way Hydro Sweep Wash Arm straight up. Check underside of wash arm to make sure the opening of the single stainless steel spray nozzle (D) and the nine water jets (E) are not blocked.

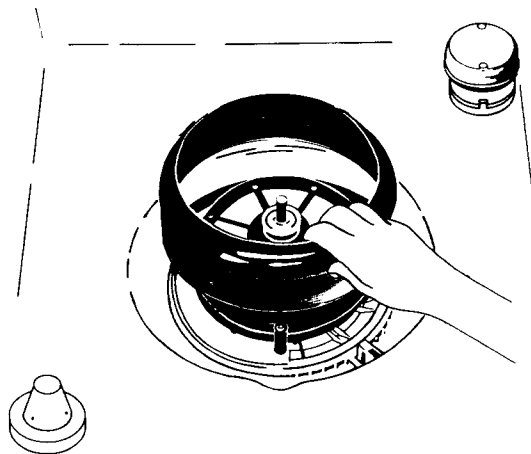

The coarse strainer may be removed if necessary. **TO REMOVE**, lift strainer out by squeezing center section (F) and remove. **TO REPLACE**, squeeze center section so clips snap into square notch.

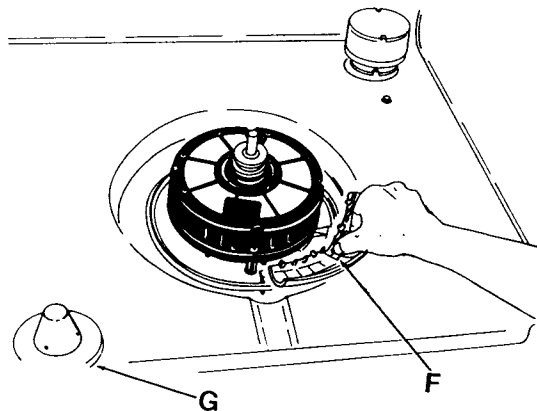

Next, remove the removable filter, by lifting the filter straight up and out. **TO CLEAN**, scrub filter with a stiff brush under running water. **TO REPLACE**, snap removable filter over the ultrafine filter and then replace the wash arm. When replacing wash arm, be sure that water jets on the wash arm are facing up.

The Overflow Protection Float (G) in the front left corner of the dishwasher tank prevents the dishwasher from overflowing. The float must be in place for the dishwasher to operate.

NOTE: A small amount of water always remains in the sump (under the ultrafine filter) to lubricate the seal.



PROBLEM, CAUSE, SOLUTION CHART

Look Here First...

A convenient checklist for handling minor performance problems. Go over this list before calling for service. If you can't solve your dishwasher's problem, turn to page 27 for service information.

PROBLEM	CAUSE	SOLUTION
Food Soil Left On Dishes	Slowdown of wash arm due to high suds	Use recommended dishwasher detergents only. Never use soap or laundry detergents. Add more dishwasher detergent to increase amount of suds-inhibitors.
	Improper loading	Follow loading instructions in dishwasher Use and Care Guide.
	Low water pressure due to insufficient fill	Home water pressure should be 20 to 120 psi for proper dishwasher fill. A booster pump on the water supply may be necessary if pressure is too low.
	Use of incorrect, too little or ineffective detergent	Use recommended dishwasher detergents only. Follow recommendations in Use and Care Guide for amounts; never use less than one tablespoon per load. Detergent must be fresh to be effective. Always store it in a cool, dry area, preferably in an airtight container.
	Detergent cakes in dispenser	Use fresh detergent only. Do not allow detergent to sit for several hours in a wet dispenser. Have dispenser checked to make sure it is working properly.
	Water temperature is too low	Turn home water heater up so water entering dishwasher is 140°F (60°C) minimum. See recommended procedure "To Check Water Temperature," page 8.
	Filter cleaning spray nozzle on wash arm is blocked	Remove lower wash arm and turn upside down. Check single stainless steel spray nozzle and nine water jets located on underside of wash arm. See page 20. Check to make sure openings are not blocked.
Spotting and Filming	Hard water or high mineral content in water	Conditioning the final rinse water with a liquid rinse agent helps eliminate spotting and filming. Keep the dispenser full with a rinse agent, such as JET DRY, at all times.
	Water temperature is too low	Turn home water heater up so water entering dishwasher is 140°F (60°C) minimum. See recommended procedure "To Check Water Temperature," page 8.
	Use of incorrect detergents	Use recommended dishwasher detergents only.
	Incorrect amount of detergent	Follow recommendations in dishwasher Use and Care Guide for amount. Heavy soil and/or hard water generally require extra detergent.
	Use of ineffective detergents	Detergent should be fresh. Store in a cool, dry place, preferably in an airtight container. Discard lumpy detergent.
	Insufficient fill caused by low water pressure	Home water pressure should be 20 to 120 psi for proper dishwasher fill. A booster pump on the water supply may be necessary if pressure is too low.
Cycle Takes Extremely Long Time	Water temperature is too low	Turn home water heater up so water entering dishwasher is 140°F (60°C) minimum. See recommended procedure "To Check Water Temperature," page 8.
Dishes Do Not Dry Completely	Dishes do not drain properly	Dishes must have proper water drainage. Do not overload. Follow instructions for loading in dishwasher Use and Care Guide. Use a liquid rinse agent to speed draining.
	Plastics	Some plastics, due to material, may need to be towel dried.

Silica Film or Etching (Silica Film is a White Iridescent Deposit; Etching is a Cloudy Film)	A water chemical reaction with certain types of glassware. Usually caused by some combination of soft or softened water, alkaline washing solutions, insufficient rinsing, overloading the dishwasher, and heat of drying.	It may not be possible to prevent problem, except by hand washing. To retard this process, use a minimum amount of detergent but not less than one tablespoon per load. Use a liquid rinse agent and underload the dishwasher to allow thorough rinsing. Remove glasses from dishwasher before dry cycle. Silica film and etching are permanent and cannot be removed.
Black or Gray Marks on Dishes	Aluminum markings	Aluminum pieces should be loaded so that they will not rub against dinnerware during washing. Throw-away aluminum items should not be dishwasher washed because they may break down and cause marking. Aluminum markings can be removed by using a mild abrasive cleanser.
Brown Stains on Dinnerware and Dishwasher Interior	High iron content in water supply	Remove by washing dishes (after food soil has been removed) with 1 teaspoon to 1 tablespoon of citric acid crystals added to Main Wash compartment of detergent dispenser. Do not use detergent. Follow with a LIGHT/CHINA WASH CYCLE with detergent. If treatment is needed more often than every other month, the installation of an iron removal unit is recommended.
White Spots on Cookware with Non-Stick Finish	Seasoning removed by dishwasher detergents	Re-season cookware after dishwasher washing.
Odor in the Dishwasher	Dishes only washed every two to three days	Run a RINSE & HOLD CYCLE at least once or twice a day until a full load is accumulated.
Chipping of Dishware	Improper loading	Load dishes and glasses so that they are stable and do not strike together from washing action. (Note: Some types of china and glassware are too delicate for automatic dishwashing and should be hand washed; for example: antiques, featheredged and similar types.) Moving racks in and out smoothly will also minimize chipping.
Removable Filter Needs Frequent Cleaning	Filter is not placed in dishwasher correctly	Make sure Removable Filter is seated properly under wash arm. See page 20.
	Spray nozzle on wash arm is blocked	Remove lower wash arm — see page 20 — and turn upside down. On under side of each tube is an indentation. In one of these indentations is a nozzle (hole) which cleans filter. Check to make sure the nozzle is not blocked.
	Dishes not scraped before loading	Make sure leftover food, bones, toothpicks and other hard items are scraped from dinnerware before loading.

To Remove Spots and Film:

To remove spots and film on dishware and glasses, or hard water film on the interior of the dishwasher, you may want to use stripping products such as LIME-A-WAY or GLASS MAGIC. These products are available in the detergent section of your local grocery store; follow the manufacturers' directions.

Or you may use vinegar with the following procedure:

1. Load clean dishes and glasses in dishwasher in regular manner. Do not load silverware or other metals in the dishwasher.
2. Close and latch door and select LIGHT/CHINA WASH CYCLE. Do not use detergent. Allow dishwasher to run through the first wash. When washer has filled for main wash portion of cycle, unlatch and open door. Add 2 cups of household vinegar. Close and latch door and re-select LIGHT/CHINA WASH CYCLE.
3. After final rinse water has drained, cancel cycle. Do not allow dishwasher to go through dry portion of cycle.
4. For a final polish, put two tablespoons of non-precipitating type water conditioner (such as CALGON) in the right-hand Main Wash compartment of detergent dispenser, and run dishwasher through complete LIGHT/CHINA WASH CYCLE.

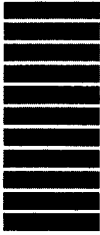

CHANGING FRONT PANELS

A new look...

Your new KitchenAid dishwasher comes with a stainless steel trim kit and one front panel installed one behind the other. You can choose from onyx black or almond. The dishwasher has been shipped with the onyx black panel showing.

If you want to change the color of the panels, follow one of the options below. OPTION A may be used if your dishwasher front protrudes several inches from the cabinets. OPTION B may be used if your dishwasher front is flush with the cabinets.

WARNING: TO PREVENT ELECTRIC SHOCK, disconnect electrical power supply to dishwasher before changing panels.

OPTION A

UPPER PANEL:

1. Pull door open and on either side of the dishwasher door, remove the three screws (A) from the trim (B). Remove the loosened piece of trim.
2. Slide the panel out. Handle carefully so the panel will not be scratched or bent. Turn the panel to the desired color. Place the color panel in position then push the filler panel in behind it.
3. Replace the trim (B) and the three screws (A).

LOWER PANEL:

1. Remove the two screws (C) on either side of the lower panel. Remove the loosened piece of trim (B).
2. Slide the panel out. Handle carefully so the panel will not be scratched or bent. Turn the panel to the desired color. Place the color panel in position then push the filler panel in behind it.
3. Replace the trim (B) and the three screws (A).

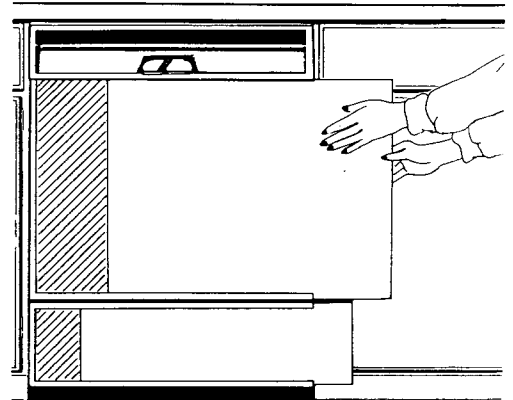
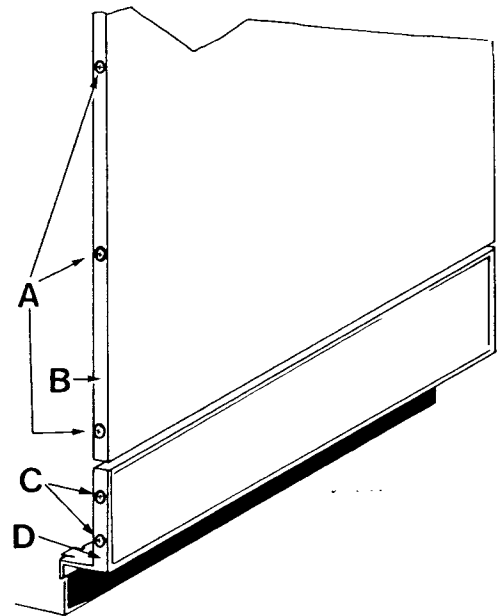

**OPTION B
UPPER PANEL:**

1. Pull door open. Remove the two screws (A) on each side of the dishwasher door that secure the upper panel assembly.
2. Close door while holding upper panel in place. Pull out lower edge of panel until top edge of panel drops down.
3. Place panel on a smooth, flat surface and remove three screws (B) from either side of panel to remove the trim strip (C).
4. Slide the panel out. Handle carefully so the panel will not be scratched or bent. Turn the panel to the desired color. Place the color panel in position then push the filler panel in behind it.
5. Replace the trim strip and the three screws.
6. With hands placed at sides of panel, slide the top edge of the panel up into position under the control panel (see illustration to the right).
7. Hold the panel in place and open the door.
8. Hold panel in position with one hand. Replace the two screws (A) on each side of the dishwasher door that secure the panel assembly.

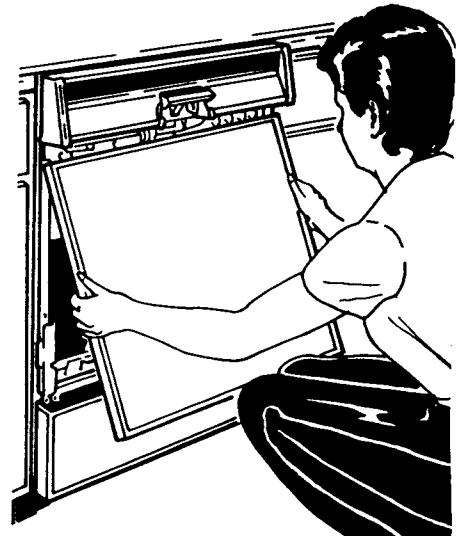
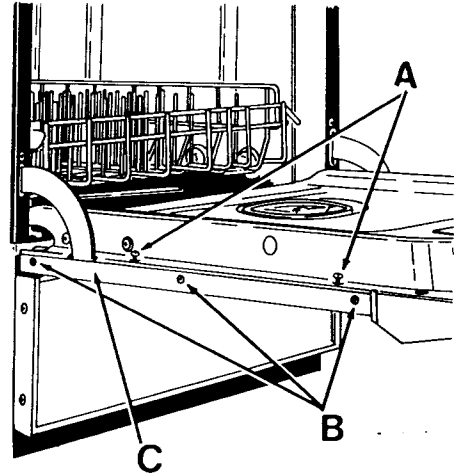



LOWER PANEL:

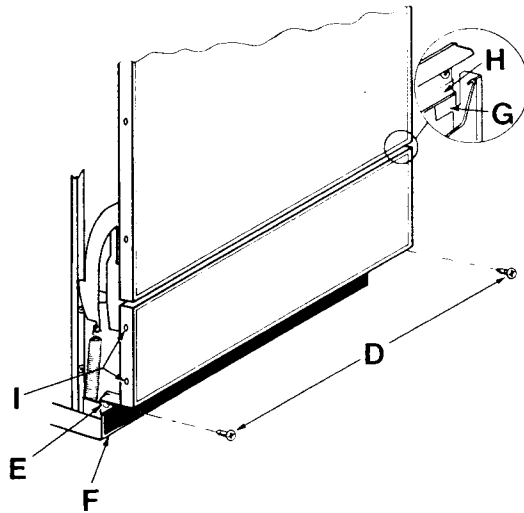

1. Remove two screws (D) located under panel.
2. With hands placed under ends of panel, lift support tabs (E) and pull out until tabs clear kick plate (F).
3. Pull lower panel down until side flanges (G) clear the support strip (H). Lower panel is then removed from dishwasher.
4. Place panel on a smooth, flat surface and remove the two screws (I) from either side of the trim. Take off the loosened piece of trim.
5. Slide the color panel out. Handle carefully so the panel will not be scratched or bent. Turn the panel to the desired color. Place the color panel in position then push the filler panel in place.
6. Replace the trim and screws (I).
7. Taking the assembled lower panel, slide the panel up onto the dishwasher front so that the side flanges (G), fit up behind the support strip (H). If this is done improperly, the lower panel will be loose and may fall off the dishwasher.

8. Lift support tabs (E) of panel up and push lower portion of panel back until support tabs (E) rest on kick plate (F).
9. Replace the screws (D).
10. Check that upper and lower panels are secure.
11. Reconnect electrical power supply.

OPTIONAL FRONT PANELS

More to Choose From

1. Wood and Decorative Panels

The stainless door trim will accommodate a custom wood front or a decorative panel insert, 1/4 inch thick. Some wood panels and decorative panels are heavy and require heavy dishwasher door springs. These may be ordered from your KitchenAid dealer as a service item, part #240418. For more information on installing a custom wood front, refer to the Dishwasher Installation instructions. If you have misplaced these instructions, please write to:

Manager
Customer Relations
KitchenAid Division
Hobart Corporation
Troy, Ohio 45374

2. Solid Colors

If the two colors provided with your dishwasher do not match your kitchen decor, optional panels are available from your KitchenAid dealer in a variety of decorator colors.



WHEN YOU NEED SERVICE

Follow These Steps

1. If your dishwasher should fail to operate, review the following list before calling your dealer. You could save the cost of a service call.

Has a fuse blown, or is the circuit breaker open?

Is the door closed and latched, and a cycle selected?

Is the overflow protection float in place?
See page 21.

Is the water supply to the dishwasher turned on?

2. If your dishwasher is not washing properly, refer to the Problem, Cause, Solution chart on page 22 before you make a service call.
3. If the problem is not due to one of the above items, see "How to Arrange for Service" listed in the Warranty Statement.
4. If you are not satisfied with the action taken, contact the Major Appliance Consumer Action Panel (MACAP). MACAP is a group of independent consumer experts that voices consumer views at the highest levels of the major appliance industry. Contact them only when the dealer, authorized servicing outlet, wholesale distributor, and Hobart Corporation have failed to resolve your problem.

Major Appliance Consumer
Action Panel
20 North Wacker Drive
Chicago, IL 60606

MACAP will in turn inform us of your action.

In all correspondence about your dishwasher, please include:

- Date
- Your Name, Address and Telephone Number
- Type of Appliance
- Brand
- Model Number
- Serial Number
- Date Purchased
- Dealer from Which Purchased (include address)
- Servicing Agent (include name and address if different from dealer's)
- Location of Appliance
- A Clear Description of the Problem and the Service Required

KITCHENAID® WARRANTY

KD-21 Series Dishwasher

LENGTH OF WARRANTY	KITCHENAID WILL PAY FOR:	KITCHENAID WILL NOT PAY FOR:
ONE YEAR FULL WARRANTY FROM DATE OF INSTALLATION.	Replacement parts and repair labor to correct defects in materials or workmanship. Service must be provided by a KitchenAid wholesale distributor or by one of their authorized KitchenAid servicing outlets.	A. Service Calls to: 1. Correct the installation of the dishwasher. 2. Instruct you how to use the dishwasher. 3. Replace house fuses or correct house wiring. 4. Correct house plumbing.
FIVE YEAR LIMITED WARRANTY ONE YEAR FULL PLUS SECOND THROUGH FIFTH YEAR LIMITED FROM DATE OF INSTALLATION.	Replacement parts (labor costs not included) for the one-half horsepower motor if defective in materials or workmanship.	B. Repairs when dishwasher is used in other than normal home use.
TEN YEAR LIMITED WARRANTY ONE YEAR FULL PLUS SECOND THROUGH TENTH YEAR LIMITED FROM DATE OF INSTALLATION.	Replacement parts (labor costs not included) for the TriDura™ Porcelain-on-steel tank or inner door if the tank or inner door develops a water leak as the result of defective materials or workmanship.	C. Damage resulting from accident, alteration, misuse, abuse, improper installation or installation not in accordance with local electrical and plumbing codes. D. Any labor costs during limited warranty. E. Replacement parts or repair labor costs for units operated outside the United States.

HOBART CORPORATION DOES NOT ASSUME ANY RESPONSIBILITY FOR INCIDENTAL OR CONSEQUENTIAL DAMAGES.

Some states do not allow the exclusion or limitation of incidental or consequential damages, so this exclusion or limitation may not apply to you.

This warranty gives you specific legal rights and you may also have other rights which vary from state to state.

HOW TO ARRANGE FOR SERVICE

- First call your dealer or repair service he recommends.
- If for some reason he is not available, or if you now reside in an area other than where the unit was purchased, look in the yellow pages of your phone book under "Dishwashing Machines" for authorized KitchenAid servicing outlets.
- If you are unable to obtain satisfactory service, contact the

KitchenAid wholesale distributor. He is listed in the yellow pages of all metro area phone books under "Dishwashing Machines."

- All service should be handled locally by the dealer from whom you purchased the unit or an authorized KitchenAid servicing outlet or wholesale distributor. If your local service is not satisfactory, contact the Customer Relations Department, KitchenAid Division, Hobart Corporation, Troy, Ohio 45374, phone 513-332-3000.