



# Use And Care

## G U I D E



STANDARD-CLEANING ELECTRIC RANGE

MODEL RF316PXY

7/93

# A Note To You

## **Thank you for buying a Whirlpool appliance.**

You have purchased a quality, *world-class* home appliance. Years of engineering experience have gone into its manufacturing. To ensure that you will enjoy many years of trouble-free operation, we have developed this Use and Care Guide. It is full of valuable information on how to operate and maintain your appliance properly and safely. Please read it carefully. Also, please complete and mail the Ownership Registration Card provided with your appliance. This will help us notify you about any new information on your appliance.

## **Your safety is important to us.**

This guide contains safety symbols and statements. Please pay special attention to these symbols and follow any instructions given. Here is a brief explanation of the use of each symbol.

### **⚠ WARNING**

This symbol will help alert you to such dangers as personal injury, burns, fire and electrical shock.

### **⚠ CAUTION**

This symbol will help you avoid actions which could cause product damage (scratches, dents, etc.) and damage to your personal property.

## **Our Consumer Assistance Center number, 1-800-253-1301, is toll-free, 24 hours a day.**

If you ever have a question concerning your appliance's operation, or if you need service, first see "If You Need Assistance Or Service" on page 27. If you need further help, feel free to call our Consumer Assistance Center. When calling, you will need to know your appliance's complete model number and serial number. You can find this information on the model and serial number plate (see diagram on page 6). For your convenience, we have included a handy place below for you to record these numbers, the purchase date from the sales slip and your dealer's name and telephone number. Keep this book and the sales slip together in a safe place for future reference.

**Model Number** \_\_\_\_\_

**Dealer Name** \_\_\_\_\_

**Serial Number** \_\_\_\_\_

**Dealer Phone** \_\_\_\_\_

**Purchase Date** \_\_\_\_\_

# Important Safety Instructions

## **⚠ WARNING**

To reduce the risk of fire, electrical shock, injury to persons, or damage when using the range, follow basic precautions, including the following:

### **General**

- Read all instructions before using the range.
- Install or locate the range only in accordance with the provided Installation Instructions. The range must be installed by a qualified installer. The range must be properly connected to electrical supply and grounded.



- **WARNING:** To reduce the risk of tipping of the appliance, the appliance must be secured by a properly installed anti-tip bracket. To check if the bracket is installed properly, see “The anti-tip bracket” on page 20.
- **CAUTION:** Do not store things children might want above the range. Children could be burned or injured while climbing on it.
- Do not leave children alone or unattended in area where the range is in use. They should never be allowed to sit or stand on any part of the range. They could be burned or injured.
- Do not operate the range if it is damaged or not working properly.
- Do not use the range for warming or heating the room. Persons could be burned or injured, or a fire could start.

- Use the range only for its intended use as described in this manual.



- Do not touch surface units, areas near units, heating elements or interior surfaces of oven. Surface units and heating elements may be hot even though they are dark in color. Areas near surface units and interior surfaces of an oven become hot enough to cause burns. During and after use, do not touch, or let clothing or other flammable materials contact surface units, areas near units, heating elements or interior surfaces of oven until they have had sufficient time to cool. Other surfaces of the range may become hot enough to cause burns; such as, the oven vent opening, the surface near the vent opening, the cooktop, the oven door and window.



- Do not wear loose or hanging garments when using the range. They could ignite if they touch a hot surface unit and you could be burned.

## IMPORTANT SAFETY INSTRUCTIONS

- Use only dry potholders. Moist or damp potholders on hot surfaces may result in burns from steam. Do not let potholder touch hot heating elements. Do not use a towel or bulky cloth for a potholder. It could catch on fire.
- Keep range vents unobstructed.
- Do not heat unopened containers. They could explode. The hot contents could cause burns and container particles could cause injury.
- Do not store flammable materials on or near the range. The fumes can create an explosion and/or fire hazard.
- Check to be sure glass cooking utensils are safe for use on the range. Only certain types of glass, glass-ceramic, ceramic, earthenware or other glazed utensils are suitable for cooktops without breaking due to the sudden change in temperature.
- Never leave surface units unattended at high heat settings. A boilover could result and cause smoking and greasy spillovers that may ignite.

### **When using the cooktop**

- Do not cook on a broken cooktop. If cooktop should break, cleaning solutions and spillovers may penetrate the broken cooktop and create a risk of electrical shock. Contact a qualified technician immediately.
- Select a pan with a flat bottom that is about the same size as the surface unit. If pan is smaller than the surface unit, some of the heating element will be exposed and may result in the igniting of clothing or potholders. Correct pan size also improves cooking efficiency.



- Turn pan handles inward, but not over other surface units. This will help reduce the chance of burns, igniting of flammable materials, and spills due to bumping of the pan.

### **When using the oven**

- Always position oven rack(s) in desired location while oven is cool. If a rack must be removed while oven is hot, do not let potholder contact hot heating element in oven.
- Use care when opening oven door. Let hot air or steam escape before removing or replacing food.

## Grease

- Grease is flammable. Do not allow grease to collect around cooktop or in vents. Wipe spills immediately.



- Do not use water on grease fires. Never pick up a flaming pan. Smother flaming pan on range by covering with a well-fitted lid, cookie sheet or flat tray. Flaming grease outside of pan can be extinguished with baking soda or, if available, a multipurpose dry chemical or foam-type extinguisher.

## Care and cleaning

- Clean cooktop with care. Some cleaners can produce noxious fumes if applied to a hot surface. If a wet paper towel is used to wipe spills on a hot cooking area, be careful to avoid steam burns.
- Do not clean door heat seal. It is essential for a good seal. Care should be taken not to rub, damage or move the seal. Clean only parts recommended in this Use and Care Guide.
- Do not repair or replace any part of the range unless specifically recommended in this manual. All other servicing should be referred to a qualified technician.
- Disconnect the electrical supply before servicing the range.

– SAVE THESE INSTRUCTIONS –

# Parts And Features

This section contains captioned illustrations of your range. Use them to become familiar with the location and appearance of all parts and features.

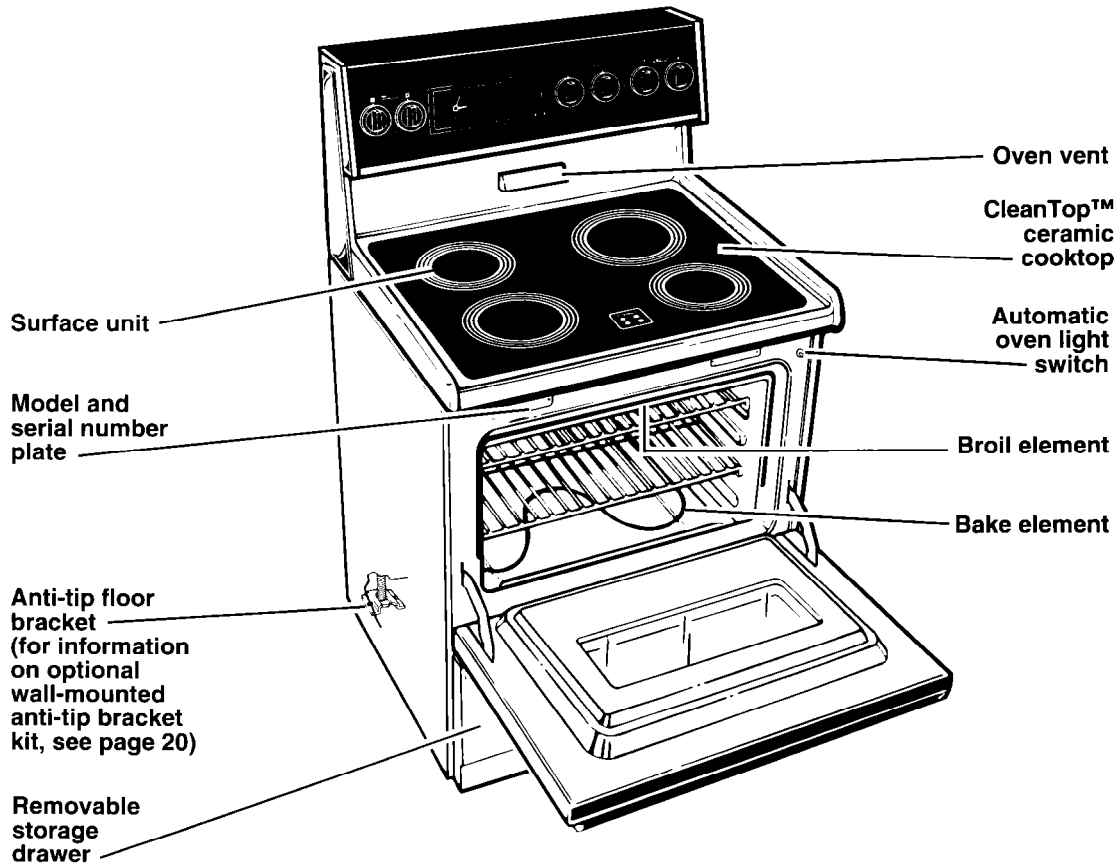

## Control panel

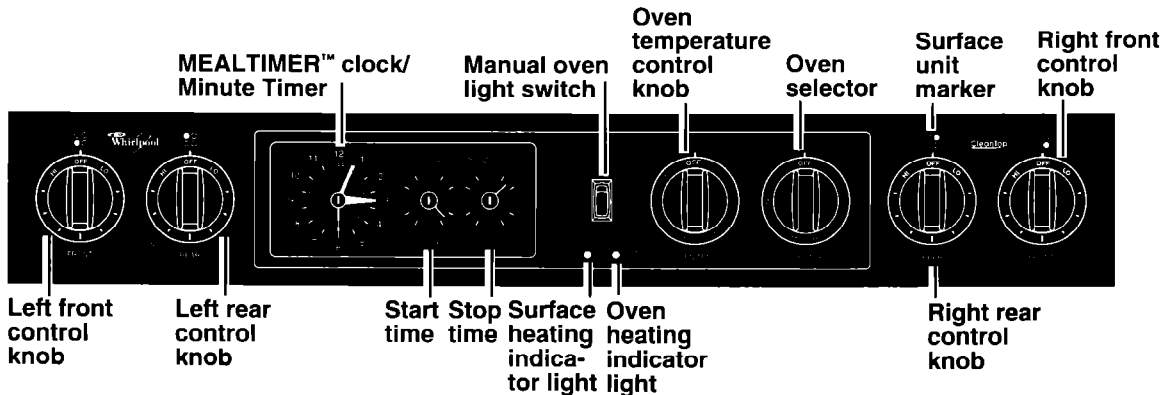

# Using Your Range

In This Section		Page	Page
Using the surface units .....	7	Broiling .....	14
Positioning racks and pans .....	9	Broiling tips .....	15
For best air circulation .....	10	Energy saving tips .....	16
Using aluminum foil for baking .....	10	Using the MEALTIMER™ clock .....	17
Setting the clock .....	11	The oven vent .....	18
Using the Minute Timer .....	11	The storage drawer .....	19
Baking/roasting .....	12	The anti-tip bracket .....	20
Adjusting the oven temperature control .....	13	Optional door panel pac .....	20

To obtain the best cooking results possible, you must operate your range properly. This section gives you important information for efficient and safe use of your range.

## Using the surface units

Push in control knobs before turning them to a setting. You can set them anywhere between HI and OFF.

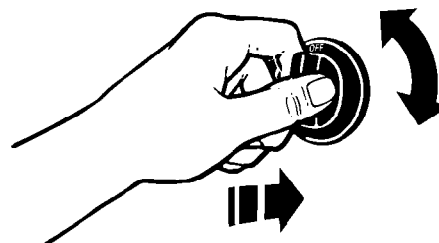

### Surface unit markers

The solid dot in the surface unit marker shows which surface unit is turned on by that knob.

### Surface heating indicator light

The SURFACE HEATING Indicator Light on the control panel will glow when a surface unit is turned on.

### Hot surface indicator lights

The Hot Surface Indicator Lights on the cooktop surface will glow when the surface units get hot. The Indicator Lights will continue to glow as long as the surface units are too hot to touch, even after they are turned off.

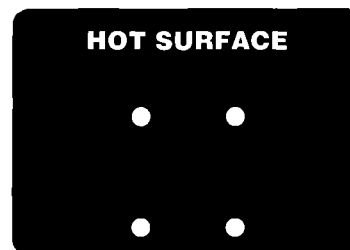

## **⚠️ WARNING**

### **Burn and Fire Hazard**

Be sure all control knobs are turned to OFF and all indicator lights are OFF when you are not cooking.

Someone could be burned or a fire could start if a surface unit is accidentally left ON.

## USING YOUR RANGE

**NOTE:** The surface elements may smoke slightly and emit a burning odor during the first few hours of use. This is normal. It is caused by the insulation material of the new ceramic cooktop elements and will not occur again.

**Until you get used to the settings, use the following as a guide.** For best results, start cooking at the high setting; then turn the control knob down to continue cooking.

SETTING	RECOMMENDED USE
HI	<ul style="list-style-type: none"><li>• To start foods cooking.</li><li>• To bring liquids to a boil.</li></ul>
Medium-high	<ul style="list-style-type: none"><li>• To hold a rapid boil.</li><li>• To fry chicken or pancakes.</li></ul>
Medium (opposite OFF)	<ul style="list-style-type: none"><li>• For gravy, pudding and icing.</li><li>• To cook large amounts of vegetables.</li></ul>
Medium-low	<ul style="list-style-type: none"><li>• To keep food cooking after starting it on a higher setting.</li></ul>
LO	<ul style="list-style-type: none"><li>• To keep food warm until ready to serve.</li></ul>

### Using the ceramic glass cooktop

Cooking on the ceramic glass cooktop is almost the same as cooking on coil surface units. There are, however, a few differences:

- **The surface unit will glow red** when it is turned on. You will see the element cycling on (glowing red) and off – even on HIGH setting – to maintain the proper temperature setting you have selected.
- **Sliding metal pans** on ceramic glass cooktop surface could leave marks. Wiping off the cooktop before and after each use will help keep the surface free from stains and provide the most even heating. See pages 22 and 23 for care and cleaning suggestions.

### Cookware tips

- **Select a pan** that is about the same size as the surface unit.

- **NOTE: For best results and greater energy efficiency,** use only flat-bottomed cookware that makes good contact with the surface units. Cookware with rounded, warped, ribbed (such as some porcelain enamelware) or dented bottoms could cause uneven heating and poor cooking results.

You can, however, use the newer cookware available with slightly indented bottoms or very small expansion channels. This cookware is specially designed to provide the good contact needed for best cooking results.

Also, woks, canners and teakettles with flat bottoms suitable for use on your cooktop are now available in most stores that sell housewares.

- **The pan** should have straight sides and a tight-fitting lid.
- **Choose medium to heavy gauge** (thickness) pans that are fairly lightweight.
- **The pan material** (metal or glass) affects how fast heat transfers from the surface unit through the pan material and how evenly heat spreads over the pan bottom. Choose pans that provide the best cooking results.
- **Handles** should be made of sturdy, heat-resistant material and be securely attached to the pan.
- **With your hand,** feel the bottom of your pans while they are cool for nicks and scratches. Nicks and scratches on pan bottoms will scratch the ceramic glass cooktop.
- **Make sure bottoms** of pans are clean and dry before using on cooktop.
- **Avoid spillovers** on cooktop. Use pans with tall sides.
- **Do not** cook food directly on cooktop.

## CAUTION

### Product Damage Hazard

Do not leave an empty utensil, or one which has boiled dry, on a hot surface unit.

The utensil could overheat and could damage the utensil or surface unit.



**Home canning information**

- **Use the largest surface unit** for best results.
- **Start with hot water.** This reduces the time the control is set on high. Reduce heat setting to lowest position needed to keep water boiling.

**Positioning racks and pans**

For baking/roasting with one rack, place the rack so the top of the food will be centered in the oven.

**Rack placement for specific foods:**

<b>FOOD</b>	<b>RACK POSITION</b>
Frozen pies, large roasts, turkeys	Lowest level or 2nd level from bottom
Angel and bundt cakes, most quick breads, yeast breads, casseroles, meats	2nd level from bottom
Cookies, biscuits, muffins, cakes, non-frozen pies	2nd or 3rd level from bottom

**When baking on two racks,** arrange racks on bottom and third level from bottom.

**NOTE:** For recommended rack placement when broiling, see “Broiling rack position chart” on page 15.

**⚠ WARNING**

**Personal Injury Hazard**

- Always position oven rack(s) in desired location before turning oven on. Be sure the rack(s) is level.
- If rack(s) must be moved while oven is hot, use potholders or oven mitts to protect hands.

Failure to follow the above precautions could result in personal injury.

### For best air circulation

Hot air must circulate around the pans in the oven for even heat to reach all parts of the oven. This results in better baking.

- **Place** the pans so that one is not directly over the other.
- **For best results, allow** 1½ to 2 inches (4-5 cm) of space around each pan and between pans and oven walls. There must be a minimum space of 1 inch (2.5 cm).
- **Use** only one cookie sheet in the oven at one time.

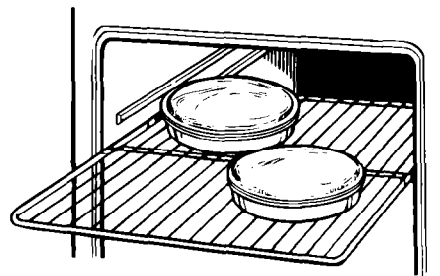

**Use the following as a guide to determine where to place the pans:**

#### One pan

Place in the center of the oven rack.

#### Two pans

Place in opposite corners of the oven rack.

#### Three or four pans

Place in opposite corners on each oven rack. Stagger pans so no pan is directly over another.

### Using aluminum foil for baking

**Use aluminum foil to catch spillovers from pies or casseroles:**

- **Place** the foil on the oven rack below the rack with the food. **Turn up** foil edges and **make sure** foil is about 1 inch (3 cm) larger all around than the dish holding the food.
- **Do not cover** the entire rack with aluminum foil. It will reduce air circulation and cause poor cooking results.
- **Do not line** oven bottom or entire oven rack with foil or other liners. Poor baking will result.

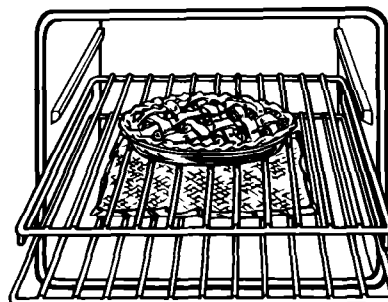

#### **⚠ WARNING**

##### **Electrical Shock and Fire Hazard**

Do not allow foil to touch the heating elements.

Failure to follow this precaution could result in electrical shock or fire hazard and damage to the elements.

## Setting the clock

Push in and turn the Minute Timer Knob to set the clock.

1. **Push in Minute Timer Knob and turn clockwise** until clock shows the correct time of day.



2. **Let the Minute Timer Knob pop out.** Turn clockwise until Minute Timer hand points to OFF. **The clock setting will change if you push in the knob when turning.**



## Using the Minute Timer

The Minute Timer does not start or stop the oven. It works like a kitchen timer. Set it in minutes up to an hour. You will hear a buzzer when the set time is up.

**NOTE: Do not push in the knob** when setting the Minute Timer or when stopping the buzzer. Pushing in and turning the Minute Timer Knob changes the clock setting.

1. **Without pushing it in, turn** the Minute Timer Knob counterclockwise until the timer hand passes the setting you want.



2. **Without pushing it in, turn** the knob back to the setting you want. **When the time is up, a buzzer will sound. To stop the buzzer, turn** the Minute Timer hand to OFF.

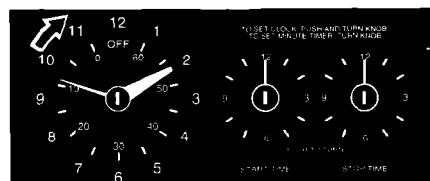

## Baking/roasting

1. **Position** the rack(s) properly **before** turning on the oven. **To change rack position, lift** rack at front and **pull out**. For further information, **see** "Positioning racks and pans" on page 9.
2. **Set** the Oven Selector to **BAKE**.
3. **Set** the Oven Temperature Control Knob to the baking/roasting temperature you want. The **OVEN HEATING Indicator Light** will come on. The oven is preheated when the **OVEN HEATING Indicator Light** first goes off.

**NOTE:** Do not preheat oven when roasting or cooking items such as casseroles.

4. **Put** food in the oven. During baking/roasting, the elements will turn on and off to maintain the temperature setting. The **OVEN HEATING Indicator Light** will turn on and off with the elements.

**NOTE:** The **top element** helps heat during baking/roasting, but does not turn red.

5. **When baking/roasting is done, turn both** the Oven Selector and the Oven Temperature Control Knob to **OFF**. The **OVEN HEATING Indicator Light** will go off.

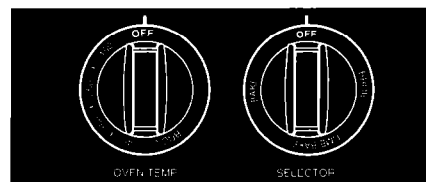
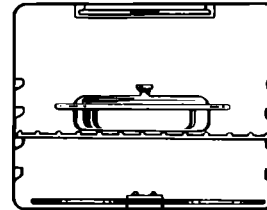
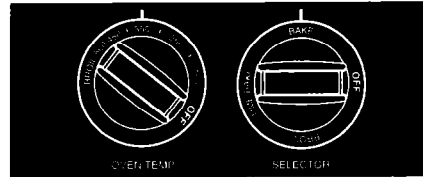

## Adjusting the oven temperature control

Oven temperature controls will gradually shift after years of use. So, even though your new oven is properly adjusted to provide accurate temperatures, it may cook faster or slower than your old oven.

If, after using the oven for a period of time, you are not satisfied with the temperature settings, you can change them by following these steps:

1. **Turn** the Oven Temperature Control Knob to the off position. **Pull** knob straight off and **flip** it over.

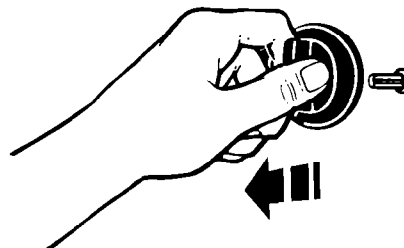

2. **Loosen** the locking screws inside the control knob. **Note the position of the notches.**
3. **To lower the temperature, hold** knob handle firmly and **move** the tooth a notch **counterclockwise**. Each notch equals about 5°F (2.5°C).
4. **To raise the temperature, hold** knob handle firmly and **move** the tooth a notch **clockwise**. Each notch equals about 5°F (2.5°C).
5. **Tighten** the locking screws and **replace** the control knob.

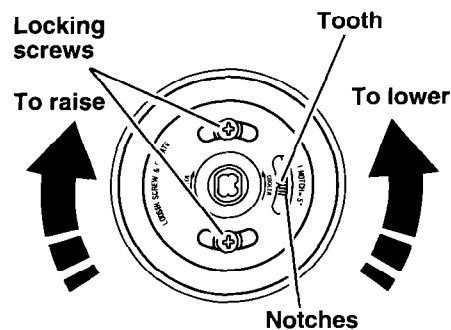

## Broiling

1. **Position** the rack before turning the oven on. See “Broiling rack position chart” on page 15.
2. **Put** the broiler pan and food on the rack.
3. **Close** the door to the Broil Stop position (open about 4 inches [10.2 cm]). The door will stay open by itself.
4. **Set** the Oven Selector and Oven Temperature Control Knob to BROIL. The OVEN HEATING Indicator Light will come on.

**NOTE:** Do not preheat oven when broiling.

5. **When broiling is done, turn both** the Oven Selector and Oven Temperature Control Knob to OFF. The OVEN HEATING Indicator Light will go off.

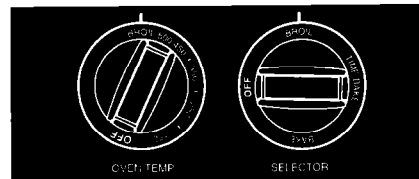

### Custom broil

- **If food is cooking too fast**, turn the Oven Temperature Control Knob **counterclockwise** until the OVEN HEATING Indicator Light goes off.
- **If you want the food to broil slower from the start**, set the Oven Temperature Control Knob between 170°F and 325°F (77°C and 163°C). These temperature settings allow the broil heating element to cycle and to slow cooking. The lower the temperature, the slower the cooking.
- **Fish and chicken** are some foods that may cook better if you use lower broiling temperatures.

**The Oven Selector must be on BROIL for all broiling temperatures.**

**NOTE:** Leave the oven door partly open whenever using the oven to broil. This allows the oven to maintain proper temperatures.

**Broiling rack position chart**

RACK POSITION FROM BOTTOM	TYPE OF FOOD/DONENESS
4	Hamburger patties and thin steaks, 1/2" thick or less
3	Quickly searing food, rare and medium steaks, medium patties, ham slices, fish steaks, frankfurters
2	Well-done steaks and patties, lamb chops, split chicken, pork steaks and chops, whole fish

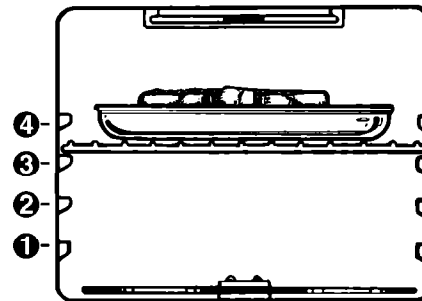

**Broiling tips**

- **Use** the broiler pan and grid for broiling. They are designed to drain excess liquid and grease away from the cooking surface to help prevent spatter, smoke or fire.
- **Refer** to a broiling chart in a reliable cookbook for correct broiling times.
- **After broiling, remove** the broiler pan from the oven when you remove the food. Drippings will bake on the pan if you leave it in the heated oven.

**⚠ WARNING**

**Fire Hazard**

- Place meat the correct distance from the element. Meat placed too close to the element could spatter, smoke, burn or catch fire during broiling.
- To ensure adequate grease drainage, do not use cookie sheets or similar pans for broiling. Also, covering the broiler grid with foil is not recommended. Poor drainage of grease could result in fire. If foil is used, cut slits in foil to line up with all openings in broiler grid. Grease can then drain away and cool in pan.

---

### Energy saving tips

Although the energy used for cooking is usually a very small percentage of the total energy used in the home, cooking energy can be used efficiently. Here are some tips to help you save energy when using your cooking product:

- **Use** pans with flat bottoms, straight sides and tight-fitting lids.
- **Match** the pan to the surface unit size.
- **Cook** with a minimum of liquid or fat to help shorten cooking time.
- **Preheat** pans only when recommended and for the shortest time possible.
- **Start** food on higher heat settings, then set surface unit control on low or off to finish cooking. Use retained heat for cooking when possible.
- **Use** the more efficient surface units instead of the oven when possible.
- **Turn on** the surface unit only after placing filled pan on the unit.
- **“Oven peeking”** may cause heat loss, longer cooking times and unsatisfactory baking results. Rely on your timer to keep track of the cooking time.
- **Bake** cakes, pies or cookies when oven is warm. Best time to bake is right after a meal has been cooked in the oven.
- **Preheat** the oven no longer than necessary.
- **Plan** your meals for the most efficient use of the range. When using the oven to cook one food, try to cook the rest of the meal in it also.
- **Do not preheat** when broiling, roasting or cooking items such as casseroles.



## Using the MEALTIMER™ clock

The MEALTIMER clock is designed to turn the oven on and off at times you set ... even when you are not around.

Delayed time baking/roasting is ideal for foods which do not require a preheated oven, such as meats and casseroles. **Do not use delayed time cooking for cakes, cookies, etc. ... undercooking will result.**

**Before using the MEALTIMER clock, make sure the clock is set to the correct time of day.** (See "Setting the clock" on page 11.)

### To delay start and stop automatically:

1. **Position** the oven rack(s) properly and **place** the food in the oven.
2. **Push in and turn** the Start Time Knob **clockwise** to the time you want baking/roasting to start.
3. **Push in and turn** the Stop Time Knob **clockwise** to the time you want the oven to shut off.
4. **Set** the Oven Selector to TIME BAKE.
5. **Set** the Oven Temperature Control Knob to the baking/roasting temperature you want. The oven will now start and stop automatically. The OVEN HEATING Indicator Light will come on when the start time is reached.
6. **After baking/roasting is done or to cancel the setting at any time, turn** both the Oven Selector and Oven Temperature Control Knob to OFF.

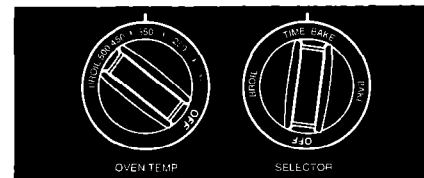
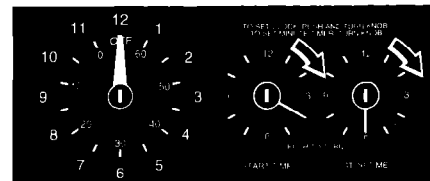

## USING YOUR RANGE

### To start baking/roasting now and stop automatically:

1. **Position** the oven rack(s) properly and **place** the food in the oven.
2. **Push in and turn** the Stop Time Knob **clockwise** to the time you want the oven to shut off. Make sure the Start Time Knob is not pushed in.
3. **Set** the Oven Selector to TIME BAKE.
4. **Set** the Oven Temperature Control Knob to the baking/roasting temperature you want.
5. **After baking/roasting is done or to cancel the setting at any time, turn** both the Oven Selector and the Oven Temperature Control Knob to OFF.

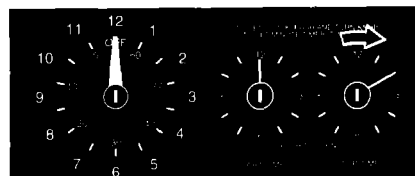

### **⚠ WARNING**

**To avoid sickness and food waste when using the MEALTIMER™ control:**

- Do not let most UNFROZEN food stand for more than two hours before cooking starts.
- Do not allow food to remain in oven for more than two hours after the end of cooking cycle.

**NOTE:** Do not use foods that will spoil while waiting for cooking to start. Such foods are: dishes with milk or eggs, cream soups, and cooked meats or fish. Also, foods containing baking powder or yeast will not rise properly when cooked using delay start.

## The oven vent

Hot air and moisture escape from the oven through a vent on the backguard below the control panel. The vent is needed for air circulation. **Do not block the vent.** Poor baking/roasting can result.

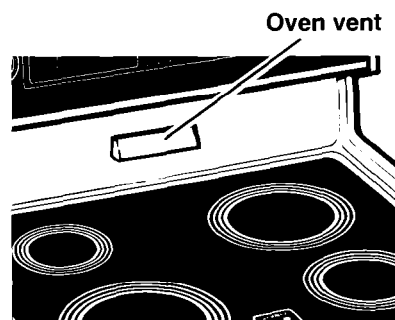

## The storage drawer

You can remove the storage drawer to make it easier to clean under the range and to check for installation of the anti-tip floor bracket (if you have one). **Use care when handling the drawer.**

### Removing the storage drawer:

1. **Empty** drawer of any pots and pans before removing drawer. **Pull** drawer straight out to the first stop. **Lift** front and **pull out** to the second stop.
2. **Lift** back slightly and **slide** drawer all the way out.

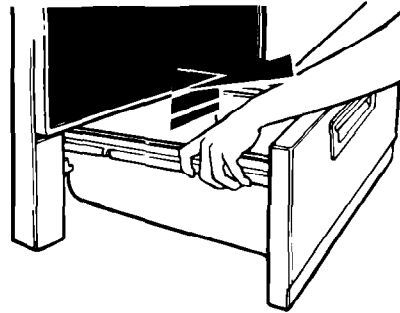

### Replacing the storage drawer:

1. **Fit** ends of drawer slide rails into the drawer guides on both sides of opening.
2. **Lift** drawer front and **push in** until metal stops on drawer slide rails clear white stops on drawer guides. **Lift** drawer front again to clear second stop and **slide** drawer closed.

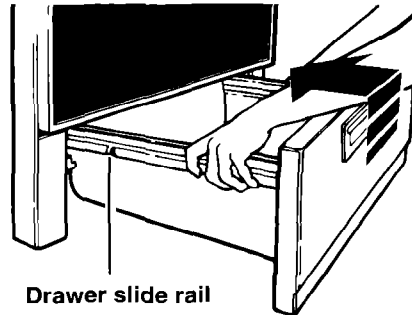

Drawer slide rail

## The anti-tip bracket

The range will not tip during normal use. However, tipping can occur if you apply too much force or weight to the open door without the anti-tip bracket properly secured.



### ⚠ WARNING

#### Personal Injury Hazard

- To reduce risk of range tipping over, secure range with a properly installed anti-tip bracket supplied with range or an optional wall-mounted anti-tip bracket kit.
- If range is moved for cleaning or service, check that anti-tip device is engaged before using range.

Failure to follow the above precautions could result in personal injury.

### To verify the anti-tip bracket is engaged (if you have a floor bracket):

- **Remove** the storage drawer. (See page 19.)
- **Look** to see if the anti-tip bracket is attached to floor with screws.
- **Make sure** one rear leveling leg is positioned under the anti-tip bracket.
- **See** Installation Instructions for further details.

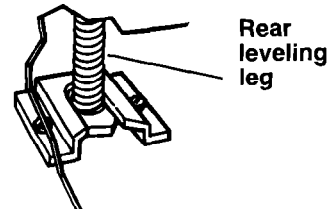

Floor bracket

### To verify the anti-tip bracket is engaged (if you have a wall bracket):

- **Look** to see if the anti-tip bracket is attached with screws to the wall behind the control panel.
- **Make sure** the cable on the back of the range is secured by the two hooks on the bracket.
- **Cable** must be unhooked from wall bracket to move range for cleaning or service. Reconnect cable before using range.
- **See** Installation Instructions for further details.

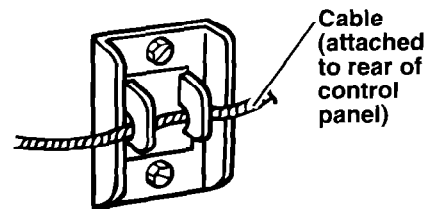

Wall bracket

## Optional door panel pac

If you would like to change the color of your oven door glass to white or almond, you can order one of these kits from your Whirlpool Dealer. The kits include easy installation instructions.

- **White** (Kit No. 814069)
- **Almond** (Kit No. 814070)

# Caring For Your Range

<b>In This Section</b>		<b>Page</b>	<b>Page</b>
<b>Cleaning the cooktop</b> .....	<b>21</b>	<b>Cleaning other range parts</b> .....	<b>24</b>
<b>Removing the oven door</b> .....	<b>23</b>	<b>The oven light</b> .....	<b>26</b>

Your range is designed for ease of care. You can do most cleaning with items found around your home. Cleaning your range whenever spills or soiling occurs will help to keep it looking and operating like new.

**⚠ WARNING**

**Burn and Electrical Shock Hazard**  
 Make sure all controls are off and the range is cool before cleaning or servicing.  
 Failure to do so could result in burns or electrical shock.

## Cleaning the cooktop

This cooktop is designed for easy care. However, ceramic cooktops need to be maintained differently than standard electric open-coil elements. Foods spilled directly on the cooktop will not burn off as on open-coil elements. Because of this, the surface should be dust-free and soil-free before heating.

Your cooktop has been prepolished at the factory for improved protection and cleanability. The Cooktop Polishing Creme (included with your unit), paper towels or a sponge, and the razor scraper included with your range is all you need to clean your cooktop. For proper cleaning methods, please review "Cleaning tips" on pages 22 and 23. Follow them after each use to ensure top performance and to preserve that uniquely elegant look.



## **⚠ WARNING**

### **Personal Injury Hazard**

- When removing heavy or sugary spills from the hot cooktop, wear oven mitts to prevent burns.
- Do not use cooktop cleaner on a hot cooktop. The cleaner could produce hazardous fumes or damage the cooktop.
- Do not use the range if the cooktop is cracked or broken.

Failure to follow these instructions could result in personal injury.

### **To avoid damaging the cooktop, follow these instructions:**

- Remove sugary spills before cooktop cools to prevent pitting.
- Do not use the cooktop as a cutting board.
- Do not allow anything that may melt (such as plastic or aluminum foil) to come in contact with the surface while it is hot.
- Do not use the ceramic cooktop to cook popcorn that comes in prepackaged aluminum containers. The container could leave aluminum marks on the cooktop that cannot be removed completely.
- Do not use steel wool, plastic cleaning pads, abrasive powdered cleansers, chlorine bleach, rust remover, ammonia or glass cleaning products with ammonia. These could damage the cooktop surface.
- Dropping heavy or hard objects on the cooktop could crack it. Be careful with heavy skillets. Do not store jars or cans above the cooktop.

## **Cleaning tips**

### **What to use:**

- **Cooktop Polishing Creme with paper towel or clean, damp sponge**—Included with your unit, this creme has been developed especially for cleaning and protecting your cooktop. When using, follow instructions on container.
- **Razor scraper**—Use to remove cooked-on soils from your ceramic cooktop. Razor blades will not scratch your cooktop. **Store razor blades out of reach of children.**  
**NOTE:** For more information on using the razor scraper, see back of scraper package.

### **Steps to follow:**

1. **Most spills** can be wiped off easily using a paper towel or clean, damp sponge as soon as Hot Surface Indicator Light(s) go off.
2. **Rub** Cooktop Polishing Creme into cooked-on soil using a paper towel. If some soil remains, leave some creme on the spot(s) and follow Step 3.
3. **Carefully scrape** spots with the razor scraper.
4. **Finish** by polishing entire cooktop with Cooktop Polishing Creme and a paper towel.

**Additional tips:**

- **Sugar spills and soils** (such as jellies and candy syrups) can cause pitting on the cooktop if not removed **while the ceramic surface is still warm**. Remove as soon as possible after the spill occurs.
- **Remove dark streaks, specks and discoloration** with Cooktop Polishing Creme.
- **Remove metal marks** (from copper or aluminum pans) with Cooktop Polishing Creme before heating the cooktop again. If heated before cleaning, metal marks may not come off.
- **Tiny scratches or abrasions do not affect cooking**. In time, these will become less visible as a result of cleaning. To prevent scratches and abrasions, use Cooktop Polishing Creme regularly.
- **Nonabrasive cleanser with damp paper towel or sponge** can be used as an alternative method for removing cooked-on soils. **Always rinse and dry your cooktop** thoroughly after using cleanser to prevent streaking or staining.

**To obtain order information for Cooktop Polishing Creme (Part No. 3184477) or razor scraper (Part No. 3183488), write to:**

Whirlpool Corporation  
Attention: Customer Service Dept.  
1900 Whirlpool Drive  
LaPorte, IN 46350

**OR**

Call **1-800-253-1301** to order. You must have a major credit card to order by phone.

---

## Removing the oven door

Removing the oven door will help make it easier to clean the oven.

### **⚠ WARNING**

#### **Burn and Electrical Shock Hazard**

Make sure all controls are OFF and the oven is cool before removing oven door.

Failure to do so could result in burns or electrical shock.

1. **Open** the door to the first stop position.
2. **Hold** the door at both sides and **lift** it at the same angle it is in.
3. **To replace**, fit the bottom corners of the door over the ends of the hinges. **Push** the door down evenly. The door will close only when it is on the hinges correctly.

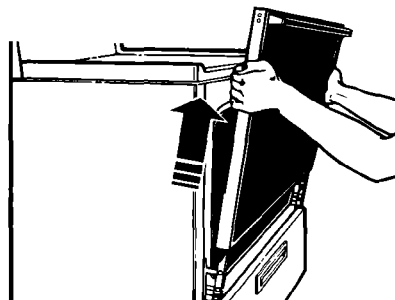

## Cleaning other range parts

Use the following table to help you clean all other parts of your range.

PART	WHAT TO USE	HOW TO CLEAN
<b>Control knobs</b>	Sponge and warm, soapy water	<ul style="list-style-type: none"> <li>• Turn knobs to OFF and pull straight away from control panel.</li> <li>• Wash, rinse and dry thoroughly. Do not soak.</li> <li>• <b>Do not use steel wool or abrasive cleansers. They may damage the finish of the knobs.</b></li> <li>• Replace knobs. Make sure all knobs point to OFF.</li> </ul>
<b>Control panel</b>	Sponge and warm, soapy water <b>OR</b> Paper towel and spray glass cleaner	<ul style="list-style-type: none"> <li>• Wash, rinse and dry thoroughly.</li> <li>• <b>Do not use steel wool or abrasive cleansers. They may damage the finish.</b></li> <li>• Do not spray cleaner directly on panel. Apply cleaner to paper towel.</li> </ul>
<b>Exterior surfaces</b> (other than cooktop and control panel)	Sponge and warm, soapy water	<ul style="list-style-type: none"> <li>• Wash, rinse and dry thoroughly.</li> <li>• Use nonabrasive, plastic scrubbing pad on heavily soiled areas.</li> <li>• <b>Do not use abrasive or harsh cleansers. They may damage the finish.</b></li> </ul>
<b>Broiler pan and grid</b> (clean after each use)	Steel-wool pad and warm, soapy water	<ul style="list-style-type: none"> <li>• Wash, rinse and dry thoroughly.</li> </ul>
<b>Oven racks</b>	Steel-wool pad and warm, soapy water	<ul style="list-style-type: none"> <li>• Wash, rinse and dry thoroughly.</li> </ul>
<b>Oven door glass</b>	Paper towel and spray glass cleaner <b>OR</b> Warm, soapy water and a nonabrasive, plastic scrubbing pad	<ul style="list-style-type: none"> <li>• Make sure oven is cool.</li> <li>• Follow directions provided with the cleaner.</li> <li>• Wash, rinse and dry thoroughly.</li> </ul>



PART	WHAT TO USE	HOW TO CLEAN
<p><b>Oven cavity</b></p>	<p>Sponge and warm, soapy water</p> <p>Soapy steel-wool pad for heavily soiled areas</p> <p><b>OR</b></p> <p>Commercial oven cleaner for heavily soiled areas</p> <p>Heavy-duty aluminum foil or shallow pan used while cooking</p>	<ul style="list-style-type: none"> <li>• Remove door for easier access. (See page 23.)</li> <li>• Wash, rinse and dry well.</li> <li>• Rinse well with water.</li> </ul> <ul style="list-style-type: none"> <li>• Remove door for easier access.</li> <li>• Place newspaper on floor to protect floor surface.</li> <li>• Follow directions provided with the oven cleaner.</li> <li>• Rinse well with clear water.</li> <li>• Use in well-ventilated room.</li> <li>• <b>Do not allow commercial oven cleaners to contact the heating elements, heat seal, thermostat or exterior surfaces of the range. Damage will occur.</b></li> <li>• Place piece of foil or shallow pan, slightly larger than the cooking container, on lower rack to catch spillovers.</li> </ul> <p><b>NOTE:</b> Do not use foil or foil liner to cover the oven floor. Poor baking/roasting results could occur.</p>

## The oven light

The oven light will come on when you open the oven door. To turn the light on when the oven door is closed, use the Oven Light Switch on the control panel.

### **⚠ WARNING**

#### **Electrical Shock and Personal Injury Hazard**

- Make sure oven and light bulb are cool and power to the range has been turned off before replacing the light bulb. Failure to do so could result in electrical shock or burns.
- The bulb cover must be in place when using the oven. The cover protects the bulb from breaking, and from high oven temperatures. Because bulb cover is made of glass, be careful not to drop it. Broken glass could cause injury.

#### **To replace the oven light:**

1. **Unplug** appliance or **disconnect** at the main power supply.
2. **Remove** the glass bulb cover in the back of the oven by screwing it out counter-clockwise.
3. **Remove** the light bulb from its socket. **Replace** the bulb with a 40-watt appliance bulb.
4. **Replace** the bulb cover by screwing it in clockwise. **Plug in** appliance or **reconnect** at the main power supply.

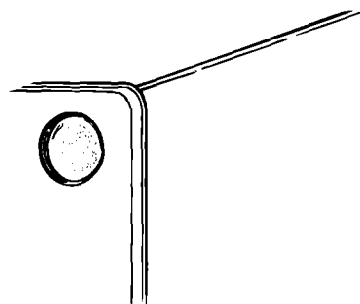
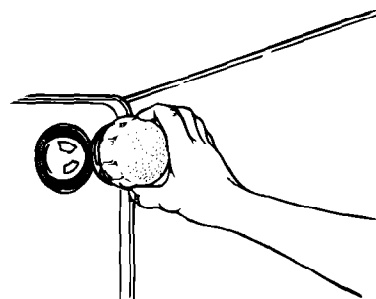

# If You Need Assistance Or Service

This section is designed to help you save the cost of a service call. Part 1 of this section outlines possible problems, their causes, and actions you can take to solve each problem. Parts 2 and 3 tell you what to do if you still need assistance or service. When calling our Consumer Assistance Center for help or calling for service, please provide a detailed description of the problem, your appliance's complete model and serial numbers and the purchase date. (See page 2.) This information will help us respond properly to your request.

## 1. Before calling for assistance ...

Performance problems often result from little things you can find and fix without tools of any kind. Please check the chart below for problems you can fix. It could save you the cost of a service call.

<b>PROBLEM</b>	<b>POSSIBLE CAUSE</b>	<b>SOLUTION</b>
<b>Nothing operates</b>	The power supply cord is not plugged into a live circuit with the proper voltage.  A household fuse has blown or a circuit breaker has tripped.	Plug power supply cord into a live circuit with proper voltage. (See Installation Instructions.)  Replace household fuse or reset circuit breaker.
<b>The oven will not operate</b>	The Oven Selector is not turned to BAKE or BROIL.  A delayed start time has been set.  The Oven Temperature Control Knob is not turned to a temperature setting.  The MEALTIMER™ clock is not set correctly.  The Stop or Start Time Knobs for the MEAL-TIMER clock are not set at the correct time of day.	Turn the Oven Selector to the desired setting.  Wait for the start time to be reached.  Turn the Oven Temperature Control Knob to the desired setting.  Set the MEALTIMER clock correctly. (See "Using the MEALTIMER clock" on page 17.)  If a delay start or stop is not desired, the Stop and Start Time Knobs must be turned to the correct time of day. Turn knobs till they pop out.
<b>Surface units will not operate</b>	A household fuse has blown or a circuit breaker has tripped.  The control knob(s) will not turn.	Replace household fuse or reset circuit breaker.  Turn knob(s) again, pushing in as you turn.

continued on next page

## IF YOU NEED ASSISTANCE OR SERVICE

PROBLEM	POSSIBLE CAUSE	SOLUTION
<b>Control knob(s) will not turn</b>	You are not pushing in before trying to turn.	Push control knob(s) in before turning to a setting.
<b>Cooking results are not what you expected</b>	<p>The range is not level.</p> <p>The oven temperature seems too low or too high.</p> <p>The oven was not pre-heated as the recipe calls for.</p> <p>The recipe has never been tested or is not from a reliable source.</p> <p>The pan used is not the type or size recommended in the recipe.</p> <p>There is not proper air circulation around pan when baking.</p> <p>The cooking utensils are not the proper shape or do not fit the surface units being used.</p>	<p>Level range. (See Installation Instructions.)</p> <p>Adjust the oven temperature control. (See "Adjusting the oven temperature control" on page 13.)</p> <p>Preheat oven if called for in recipe.</p> <p>Use only tested recipes from a reliable source.</p> <p>Refer to a reliable cookbook for recommended pan type and size.</p> <p>Allow 1½ to 2 inches (4-5 cm) on all sides of the pans for air circulation. There must be a minimum space of 1 inch (2.5 cm).</p> <p>Use cooking utensils with smooth, flat bottoms that fit the surface units being used.</p>

**2. If you need assistance ...**

Call Whirlpool Consumer Assistance Center telephone number. Dial toll-free from anywhere in the U.S.A.:

**1-800-253-1301**

and talk with one of our trained consultants. The consultant can instruct you in how to obtain satisfactory operation from your appliance or, if service is necessary, recommend a qualified service company in your area.

If you prefer, write to:

Mr. William Clark  
Consumer Assistance Representative  
Whirlpool Corporation  
2000 M-63  
Benton Harbor, MI 49022

Please include a daytime phone number in your correspondence.

**3. If you need service ...**

Whirlpool has a nationwide network of authorized Whirlpool<sup>SM</sup> service companies. Whirlpool service technicians are

trained to fulfill the product warranty and provide after-warranty service, anywhere in the United States. To locate the authorized Whirlpool service company in your area, call our Consumer Assistance Center telephone number (see Step 2) or look in your telephone directory Yellow Pages under:

**• APPLIANCE-HOUSEHOLD-MAJOR, SERVICE & REPAIR**

- See: Whirlpool Appliances or Authorized Whirlpool Service  
(Example: XYZ Service Co.)

**• WASHING MACHINES & DRYERS, SERVICE & REPAIR**

- See: Whirlpool Appliances or Authorized Whirlpool Service  
(Example: XYZ Service Co.)

**4. If you need FSP<sup>®</sup> replacement parts ...**

FSP is a registered trademark of Whirlpool Corporation for quality parts. Look for this symbol of quality whenever you need a replacement part for your Whirlpool appliance. FSP replacement parts will fit right and work right, because they are made to the same exacting specifications used to build every new Whirlpool appliance.

To locate FSP replacement parts in your area, refer to Step 3 above or call the Whirlpool Consumer Assistance Center number in Step 2.

**5. If you are not satisfied with how the problem was solved ...**

- Contact the Major Appliance Consumer Action Panel (MACAP). MACAP is a group of independent consumer experts that voices consumer views at the highest levels of the major appliance industry.
- Contact MACAP only when the dealer, authorized servicer and Whirlpool have failed to resolve your problem.

Major Appliance Consumer Action Panel  
20 North Wacker Drive  
Chicago, IL 60606

- MACAP will in turn inform us of your action.

# WHIRLPOOL®

## CleanTop™ Freestanding Range Warranty

LENGTH OF WARRANTY	WHIRLPOOL WILL PAY FOR
<b>FULL ONE-YEAR WARRANTY</b> From Date of Purchase	FSP® replacement parts and repair labor to correct defects in materials or workmanship. Service must be provided by an authorized Whirlpool <sup>SM</sup> service company.
<b>FULL FIVE-YEAR WARRANTY</b> From Date of Purchase	FSP replacement parts and repair labor for CleanTop ceramic cooktop to the original purchaser of this product. Whirlpool warrants that: <ul style="list-style-type: none"> <li>- The ceramic cooktop will not discolor</li> <li>- The ceramic cooktop pattern will not wear off</li> <li>- The rubber seal between the ceramic cooktop and porcelain edge will not crack</li> <li>- The ceramic cooktop will not crack due to thermal shock</li> <li>- The surface units will not burn out</li> </ul>
<b>LIMITED WARRANTY FOR LIFE OF THE PRODUCT</b> Second Year Through Life of Product From Date of Purchase	FSP replacement parts for control knobs.
<b>WHIRLPOOL WILL NOT PAY FOR</b>	
<p><b>A.</b> Service calls to:</p> <ol style="list-style-type: none"> <li>1. Correct the installation of your range.</li> <li>2. Instruct you how to use your range.</li> <li>3. Replace house fuses or correct house wiring.</li> <li>4. Replace owner accessible light bulbs.</li> </ol> <p><b>B.</b> Repairs when your range is used in other than normal, single-family household use.</p> <p><b>C.</b> Pickup and delivery. Your range is designed to be repaired in the home.</p> <p><b>D.</b> Damage to your range caused by accident, misuse, fire, flood, acts of God or use of products not approved by Whirlpool.</p> <p><b>E.</b> Any labor costs during limited warranty.</p> <p><b>F.</b> Repairs to CleanTop ceramic cooktop if it has not been cared for as recommended in this Use and Care Guide.</p> <p><b>G.</b> Repairs to parts or systems caused by unauthorized modifications made to the appliance.</p>	

5/93

WHIRLPOOL CORPORATION SHALL NOT BE LIABLE FOR INCIDENTAL OR CONSEQUENTIAL DAMAGES. Some states do not allow the exclusion or limitation of incidental or consequential damages, so this limitation or exclusion may not apply to you. This warranty gives you specific legal rights, and you may also have other rights which vary from state to state.

Outside the United States, a different warranty may apply. For details, please contact your authorized Whirlpool distributor or military exchange.

If you need service, first see the "Assistance or Service" section of this book. After checking "Assistance or Service," additional help can be found by calling our Consumer Assistance Center telephone number, **1-800-253-1301**, from anywhere in the U.S.A.

**PART NO. 3187471**

© 1993 Whirlpool Corporation

© Registered Trademark/TM Trademark/SM Service Mark of Whirlpool Corporation.

Printed in U.S.A.