

# ELECTRONIC OVEN CONTROL

## Control Pad Functions

**Read the instructions carefully before using the oven.** For satisfactory use of your oven, become familiar with the various functions of the oven as described below. **Note:** The graphics on your timer may not look exactly like those shown. This doesn't change the way it operates. Also Push buttons or pads may be shaped differently.

**Oven Light**— Use to turn the oven light ON and OFF.

**Speed Clean** — Use to select a 2 hour Self-Cleaning cycle.

**Clean**— Use to select a 3 hour Self-Cleaning cycle.

**Bake Time**— Use to enter the length of the baking time.

**Clock**— Use to set the time of day.

**Maxx Clean**— Use to select a 4 hour Self-Cleaning cycle.

**Lock Controls**— Use to enable or disable all oven features and lock the oven door.

**Start Time**— Use with **Bake, Bake Time** and **Clean Pads** to program a Delayed Timed Bake or Delay Self-Cleaning cycle.

**Timer ON/OFF**— Use to set or cancel the minute timer.

**Bake**—Use to enter the normal baking feature.

**Broil**— Use to select variable Broil feature.

**Keep Warm** — Use to select the Keep Warm feature.

**0 Thru 9 number pads**— Use to enter temperature and times.

**Start**— Use to start all oven features (not used with Oven Light).

**Conv Convert**— Use to select the Convection Convert feature.

**Conv Bake**— Used to select the convection bake feature.

**Conv Roast**— Use to select the Convection Roast feature.

**Favorite**— Use to recall stored recipes.

**Clear/Off** - Use to cancel any oven mode previously entered except the Time of Day & Minute Timer.

## Minimum & Maximum Control Pad Settings

All the features listed have minimum and maximum time or temperature settings that may be entered into the control. An ENTRY acceptance beep will sound each time a control pad is touched (the Oven Lockout pad is delayed by 3 seconds).

An ENTRY ERROR tone (3 short beeps) will sound if the entry of the temperature or time is below the minimum or above the maximum settings for the feature.

FEATURE	MIN. TEMP./TIME	MAX. TEMP./TIME
BAKE TEMP.	170°F/77°C	550°F/288°C
BROIL TEMP.	400°F/205°C	550°F/288°C
TIMER	12 Hr. 24 Hr.	11:59 Hr./ Min. 11:59 Hr./ Min.
CLOCK TIME	12 Hr. 24 Hr.	12:59 Hr./ Min. 23:59 Hr./ Min.
COOK TIME	12 Hr. 24 Hr.	11:59 Hr./ Min. 11:59 Hr./ Min.
START TIME	12 Hr. 24 Hr.	12:59 Hr./ Min. 23:59 Hr./ Min.
CONVECTION BAKE	325°F/ 163°C	550°F/288°C
CONVECTION ROAST	325°F/ 163°C	550°F/288°C





## Setting the Clock

The  pad is used to set the clock. The clock may be set for 12 or 24 hour time of day operation. The clock has been preset at the factory for the 12 hour operation. When the range is first plugged in, or when the power supply to the range has been interrupted, the timer in the display will flash along with "PF" (power failure, See Fig. 1).

When PF appears in the display and 12:00 is flashing, press . No sound will be heard, but after 10 seconds a beep will sound and PF will disappear.

### INSTRUCTIONS

#### To set the clock (example below for 1:30)

1. Press . "CLO" will appear in the display (Fig. 2).
2. Press    pads to set the time of day to 1:30 (Fig. 3). "CLO" will stay in the display. Press . "CLO" will disappear and the clock will start (Fig. 4).

#### Changing between 12 or 24 hour time of day display





1. Press and hold  for 7 seconds (Fig. 3). After 7 seconds, "12Hr" (Fig. 5) or "24Hr" (Fig. 6) will appear in the display and the control will beep once.
2. Press  to switch between the 12 and 24 hour time of day display. The display will show either "12Hr" (Fig. 5) or "24Hr" (Fig. 6).
3. Press  to accept the change or press  to reject the change.
4. Reset the correct time as described in **To set the Clock** above. Please note that if the 24 hour time of day mode was chosen, the clock will now display time from 0:00 through 23:59 hours.



Fig. 1

### PRESS

### DISPLAY



Fig. 2



Fig. 3



Fig. 4



Fig. 5





Fig. 6

 for 7 seconds







 or 

## Setting Temperature Display — Fahrenheit or Celsius:

The **BROIL**  and **CLEAN**  pads control the Fahrenheit or Celsius temperature display modes. The oven control can be programmed to display temperatures in Fahrenheit or Celsius. The oven has been preset at the factory to display in Fahrenheit.

### INSTRUCTIONS

#### To change display from Fahrenheit to Celsius or Celsius to Fahrenheit

1. To tell if the display is set for Fahrenheit or Celsius press  (Fig. 7) and hold for 7 seconds; "550°" will appear and "BROIL" will flash in the display and a beep will sound. If "F" appears, the display is set to show temperatures in Fahrenheit (Fig. 8). If "C" appears, the display is set to show temperatures in Celsius (Fig. 9).
2. Press  to switch between Fahrenheit or Celsius display modes. The display will show either "F" (Fig. 8) or "C" (Fig. 9).
3. Press  to accept the change or press  to reject the change.

### PRESS

### DISPLAY



Fig. 7

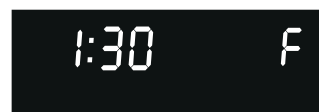

Fig. 8



Fig. 9



 for 7 seconds



 or 





## Setting the Clock (continued)

### Setting Continuous Bake or 12 Hour Energy Saving

The **TIMER ON/OFF**  and **CLEAN**  pads control the Continuous Bake or 12 Hour Energy Saving features. The oven control has a factory preset built-in 12 Hour Energy Saving feature that will shut off the oven if the oven control is left on for more than 11 hours and 59 minutes. The oven can be programmed to override this feature for Continuous Baking.

#### INSTRUCTIONS

##### To set the control for Continuous Bake or 12 Hour Energy Saving features

1. Press and hold  for 7 seconds (Fig. 1). After 7 seconds "12Hr" or "-:Hr" will appear in the display and the control will beep once.
2. Press  to switch between the 12 Hour Energy Saving and continuous bake features. Note: "12Hr" (Fig. 2) in the display indicates the control is set for the 12 Hour Energy Saving mode and "-:Hr" indicates the control is set for the Continuous Bake feature (Fig. 3).
3. Press  to accept the change (Fig. 4; display will return to time of day) or press  to reject the change.

#### PRESS

 for 7 seconds





or 

#### DISPLAY



Fig. 1



Fig. 2



Fig. 3

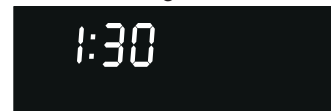







Fig. 4

### Setting Timer

The **TIMER ON/OFF**  pad controls the Timer feature. The Timer serves as an extra timer in the kitchen that will beep when the set time has run out. It does not start or stop cooking. The Timer feature can be used during any of the other oven control functions. Refer to "Minimum and Maximum Control Pad Settings" for time amount settings.

#### INSTRUCTIONS

##### To set the Timer (example for 5 minutes)

1. Press . "0:00" will appear and "TIMER" will flash in the display (Fig. 5).
2. Press the number pads to set the desired time in the display (example ). Press . The time will begin to count down with "5:00" and "TIMER" will stay in the display (Fig. 6). Note: If  is not pressed the timer will return to the time of day after 25 seconds.
3. When the set time has run out, "End" and "TIMER" will show in the display (Fig. 7). The clock will sound with 3 beeps every 7 seconds until  is pressed.

#### PRESS









#### DISPLAY



Fig. 5



Fig. 6



Fig. 7

##### To cancel the Kitchen Timer before the set time has run out

Press . The display will return to the time of day.



# Consumer Defined Controls

Note: The Consumer Defined Control features are adjustments to the control that will not affect cooking results. These include the Oven Lockout, Silent Control Operation and Temperature Display features.

## Setting Oven Lockout Feature

The  pad controls the Oven Lockout feature. The Oven Lockout feature automatically locks the oven door and prevents the Oven from being turned on. It does not disable the clock, Kitchen Timer or the interior oven lights.

### INSTRUCTIONS

### PRESS

### DISPLAY

#### To activate the Oven Lockout feature

1. Press and hold  for 3 seconds.
2. After 3 seconds a beep will sound, "LOC" will appear and "DOOR LOCKED" will flash in the display (Fig. 1). Once the oven door is locked the "DOOR LOCKED" indicator will stop flashing.

 for 3 seconds





#### To reactivate normal oven operation:

1. Press and hold  for 3 seconds. A beep will sound. "LOC" will disappear. The "DOOR LOCKED" will flash in the display until the oven door has completely unlocked (Fig. 2).
2. The oven is again fully operational.

 for 3 seconds



## Setting Silent Control Operation





The **START TIME**  and **CLEAN**  pads control the Silent Control operation feature. The Silent Control operation feature allows the oven control to be operated without sounds or beeps whenever necessary. If desired the control can be programmed for silent operation and later returned to operating with all the normal sounds and beeps.

### INSTRUCTIONS

### PRESS

### DISPLAY

#### To change control from normal sound operation to silent control operation

1. To tell if your range is set for normal or silent operation press and hold  for 7 seconds. "0:00" will appear and "DELAY" will flash in the display (Fig. 3). After 7 seconds ":SP" will appear in the display (Fig. 4).
2. Press  to switch between normal sound operation and silent operation mode. The display will show either ":SP" (Fig. 4) or ":-" (Fig. 5).  
If ":SP" appears (Fig. 4), the control will operate with normal sounds and beeps. If ":-" appears (Fig. 5), the control is in the silent operation mode.
3. Press  to accept the change or press  to reject the change.

 for 7 seconds





 OR 





# Setting Oven Controls (continued)

## Setting Bake

The **BAKE**  pad controls normal baking. The oven can be programmed to bake at any temperature from 170° F to 550° F (The example shown below is for 350° F).





### INSTRUCTIONS

#### To set the Bake Temperature to 350° F

1. Arrange interior oven racks and place food in oven.
2. Press , "--- °" will appear and "**BAKE**" will flash in the display (Fig. 1).
3. Press    (Fig. 2). "**BAKE**" will continue to flash and "350°" will appear in the display.
4. Press . A beep will sound once the oven temperature reaches 350° F and the display will show "350°" and "**BAKE**" (Fig. 3).

Pressing  will cancel the Bake feature at any time.

#### To change the Bake Temperature (example: changing from 350° F to 425° F)

1. After the oven has already been set to bake at 350° F and the oven temperature needs to be changed to 425° F, press  (Fig. 4). "--- °" will appear and "**BAKE**" will flash in the display.
2. Press    (Fig. 5). "**BAKE**" will continue to flash and "425°" will appear in the display.
3. Press . "**BAKE**" and "425°" will stay in the display (See Fig. 6).

Note: If the oven was recently heated from prior cooking and has remained heated, the bake element symbol may not show in the display immediately.

### PRESS



### DISPLAY



Fig. 1

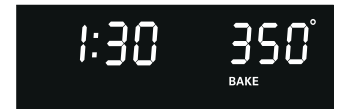

Fig. 2



Fig. 3



Fig. 4



Fig. 5



Fig. 6

# Setting Oven Controls (continued)

## Setting Convection Bake

The **CONV BAKE**  pad controls the Convection Bake feature. Use the Convection Bake feature when cooking speed is desired. The oven can be programmed for Convection baking at any temperature between 325° F (163°C) to 550° F (288° C).

Convection baking uses a fan to circulate the oven's heat evenly and continuously within the oven. This improved heat distribution allows for even cooking and excellent results using multiple racks at the same time. Foods cooked on a single oven rack will generally cook faster and more evenly with Convection Bake. Multiple oven rack cooking may slightly increase cook times for some foods, but the overall result is time saved. Breads and pastries brown more evenly.

### General Convection Bake Instructions

1. When using Convection Bake, decrease your normal cooking times as shown aside. Adjust the cook time for desired doneness as needed. Time reductions will vary depending on the amount and type of food to be cooked. Cookies and biscuits should be baked on pans with no sides or very low sides to allow heated air to circulate around the food. Food baked on pans with a dark finish will cook faster.
2. Preheating is not necessary when cooking casseroles with Convection Bake.
3. When using Convection Bake with a single rack, place oven rack in position 2 or 3. If cooking on multiple racks, place the oven racks in positions 2 and 3.

#### Benefits of Convection Bake:

- Some foods cook up to 25% to 30% faster, saving time and energy.
- Multiple rack baking.
- No special pans or bakeware needed.

#### Foods for CONVECTION BAKE pad \*Decrease normal cook time by:





Frozen foods, pies, .....	15-25 %
pastries and pizza	
Refrigerator cookies .....	15-35 %
Refrigerator biscuits .....	15-30 %
Rolls & Breads .....	20-25%
Fresh Pies/Pastries .....	10-20 %

Begin with the maximum reduction in cook times and adjust as needed.

\*Recommended reduction in cook times based on brands of food items tested. Cook times may vary with your specific brand of food item.

### INSTRUCTIONS

#### To set the oven for Convection Bake and temperature to 350°F

1. Arrange interior oven racks and place food in oven.
2. Press . "CONV BAKE" will flash and "---°" will appear in the display (Fig. 1).
3. Press   . "CONV BAKE" and "350°" will appear in the display (Fig. 2).
4. Press . "CONV BAKE" and the oven temperature **adjustment** will appear in the display (for this example it is 325°C). A beep will sound once the **adjusted** oven temperature is reached. The display will show "325°", "CONV BAKE" and the fan icon (Fig. 3).

Note: The convection fan will start AS SOON AS the oven is set for Convection Bake. The display will show an icon of rotating fan within a square. This rotating fan icon indicates when the Convection Fan is operating.

Press  to stop Convection Bake or cancel Convection Bake at any time.

Note: As soon as the  pad is pressed the set temperature will be decreased by 25°F (13°C).

### PRESS

### DISPLAY





Fig. 1



Fig. 2





Fig. 3









# Setting Oven Controls (continued)

## Setting Convection Roast

The **CONV ROAST**  pad is designed to give optimum cooking performance for this feature. The Convection Roast pad combines a cook cycle with the convection fan and element to roast meats and poultry. Preheating is not necessary for meats and poultry. Heated air circulates around the food from all sides, sealing in juices and flavors. Foods are crispy brown on the outside while staying moist on the inside.

### INSTRUCTIONS

#### To set the Convection Roast feature (example: Meats to cook at 350°F)

1. Arrange interior oven racks and place food in oven.
2. Press . "CONV" will flash and "---°" will be displayed (See Fig. 1).
3. Press   . "CONV" will flash and "350°" will appear in the display (See Fig. 2).
4. Press . "CONV" and "350°" will appear in the display (See Fig. 3). The convection fan icon will come on.

Press  to stop Convection Roast at any time.

### PRESS



### DISPLAY



Fig. 1



Fig. 2



Fig. 3

### Roasting Rack Instructions (some models)

When preparing meats for convection roasting, use the broiler pan and insert along with the roasting rack (if equipped). The broiler pan will catch grease spills and the insert will help prevent grease splatters. The roasting rack will allow the heat to circulate around the meat.

**⚠ WARNING** To prevent food from contacting the broil element and to prevent grease splattering, **DO NOT** use the roasting rack when broiling.

1. Place oven rack on bottom or next to the bottom rack position.
2. Place the insert in the broiler pan. The roasting rack fits on the insert allowing the heated air to circulate under the food for even cooking and helps to increase browning on the underside. Make sure the roasting rack is securely seated on the insert in the broiler pan. **DO NOT** use the broiler pan without the insert. **DO NOT** cover the insert with aluminum foil.
3. Position food (fat side up) on the roasting rack (See Fig. 4).
4. Place the broiler pan on the oven rack.

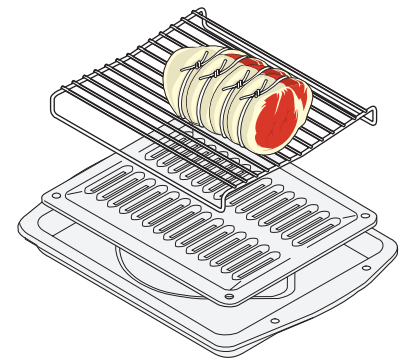



Fig. 4

## Setting Oven Controls (continued)

### Setting Convection Convert feature





The  **CONV CONVERT** pad is used to automatically convert a standard **baking** recipe for convection baking. When set properly, this feature is designed to display the actual converted (reduced) temperature in display.

Convection Convert may **ONLY** be used with a **Bake, Timed Bake** or a **Delay Start** (Delayed Timed Bake) setting. When used with a Timed Bake or a Delayed Timed Bake setting, the Convection Convert feature will display a "**CF**" for check food when the bake time is 75% complete (See Fig. 4). At this time the oven control will sound 3 long beeps at regular intervals until baking has finished. When the bake time has completely finished the control will display "**End**" and will sound 3 long

beeps every 30 seconds until the  pad is pressed (See Fig. 5).

#### INSTRUCTIONS

#### Using Convection Convert (Bake) feature to automatically adjust oven temperature (example: setting oven for 350°F):

1. Arrange interior oven racks and place food in oven.
2. Press , "- - - °" will appear in the display (Fig. 1).
3. Press   . "**BAKE**" will flash and "**350°**" will appear in the display (See Fig. 2). If a Timed Bake or a Delayed Start (Delayed Timed Bake) is desired, enter the times now.
4. Press . "**CONV BAKE**" and the oven temperature **adjustment** will appear in the display (for this example it is 325°F). A beep will sound once the **adjusted** oven temperature is reached. The display will show "**325°**", "**CONV BAKE**" and the fan icon (Fig. 3).

Note: The oven icon will show a rotating fan within the square. This rotating fan icon indicates when the Convection Fan is operating (See rotating fan in Fig. 3).

Press  to cancel Convection feature at any time.

**Note:** The minimum amount of cook time using the Convection Convert feature with a **Timed Bake** or a **Delay Start** (Delayed Timed Bake) is 20 minutes.

#### PRESS

#### DISPLAY



Fig. 1



Fig. 2



Fig. 3



Fig. 4







Fig. 5



# Setting Oven Controls (continued)

## Setting Timed Bake, Timed Convection Bake or Timed Convection Roast









The **BAKE**  or **CONVECTION BAKE**  or **CONVECTION ROAST**  and **BAKE TIME**  pads control the Timed Bake feature. The automatic timer of the Timed Bake feature will turn the oven OFF after cooking for the desired amount of time you selected.

### INSTRUCTIONS

### PRESS

### DISPLAY

To program the oven to begin baking immediately and to shut off automatically (example: **BAKE** at 350°F for 30 minutes)

1. Be sure the clock is set for the correct time of day.
2. Arrange interior oven rack(s) and place the food in the oven.
3. Press , " --- °" will appear and "**BAKE**" will flash in the display (Fig. 1).
4. Press    (Fig. 2). "**BAKE**" will continue to flash and "**350°**" will appear in the display.
5. Press . "**BAKE**" and "**350°**" will appear in the display (See Fig. 3).
6. Press . "**TIMED**" will flash; "**BAKE**", "**0:00**" and "**350°**" will appear in the display (Fig. 4).
7. Enter the desired baking time by pressing  . "**TIMED**" will continue to flash and "**BAKE**", "**30:00**" and "**350°**" will stay in the display (Fig. 5). Note: Baking time can be set for any amount of time between 1 minute to 11 hours and 59 minutes.
8. Press . Both the "**TIMED**" and "**BAKE**" icons will remain on in the display (Fig. 6). Once the Timed Bake feature has started, the current time of day will appear in the display.

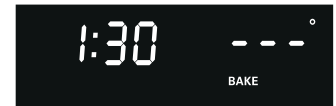

Fig. 1

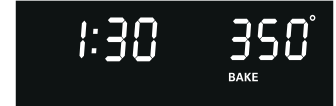

Fig. 2



Fig. 3



Fig. 4



Fig. 5



Fig. 6

Note: After the Timed Bake feature has activated, press  to display the bake time remaining in the Timed Bake mode. Once Timed Bake has started baking, a beep will sound when the oven temperature reaches the set temperature.

Press  when baking has finished or at any time to cancel the Timed Bake feature.



### When the timed bake finishes:

1. "**End**", "**TIMED**", "**BAKE**" and the time of day will show in display. The oven will shut off automatically (Fig. 7).
2. The control will beep 3 times. The control will continue to beep 3 times every 30 seconds until  is pressed.



Fig. 7

**NOTE:** Remember that the lowest **BAKE** temperature is 170°F and that the lowest **CONVECTION BAKE & CONVECTION ROAST** temperature is 325°F.

**CAUTION** Use caution with the **TIMED BAKE** or **DELAYED TIME BAKE** features. Use the automatic timer when cooking cured or frozen meats and most fruits and vegetables. Foods that can easily spoil such as milk, eggs, fish, meat or poultry, should be chilled in the refrigerator first. Even when chilled, they should not stand in the oven for more than 1 hour before cooking begins, and should be removed promptly when cooking is completed. Eating spoiled food can result in sickness from food poisoning.

# Setting Oven Controls (continued)

## Setting Delayed Timed Bake, Delayed Timed Convection Bake or Convection Roast















The **BAKE**  or **CONVECTION BAKE** , or **CONVECTION ROAST** , **BAKE TIME**  and **START TIME**  pads control the Delayed Time Bake feature. The automatic timer of the Delayed Time Bake will turn the oven **on and off** at the time you select in advance. **Note:** If your clock is set for normal 12 hour display mode the Delayed Timed Bake or Delayed Timed Convection Bake cycle can never be set to start more than 12 hours in advance. To set for Delayed Timed Bake or Delayed Timed Convection Bake 12-24 hours in advance set the control for the 24 hour time of day display mode.

### INSTRUCTIONS

### PRESS

### DISPLAY

To program the oven for a delayed **BAKE** start time and to shut off automatically (example: baking at 350°F, starting at 5:30 and baking for 30 minutes)

1. Be sure that the clock is set with the correct time of day.
2. Arrange interior oven rack(s) and place the food in the oven.
3. Press . "---°" will appear and **"BAKE"** will flash in the display (Fig. 1).
4. Press    (Fig. 2). **"BAKE"** will continue to flash and **"350°"** will appear in the display.
5. Press . **"BAKE"** and **"350°"** will stay in the display. (See Fig. 3).
6. Press . **"TIMED"** will flash, **"0:00"** will appear and **"BAKE"** and **"350°"** will remain in the display (Fig. 4).
7. Enter the desired baking time using the number pads by pressing  . **"TIMED"** will flash; **"BAKE"**, **"30:00"** and **"350°"** will appear in the display (Fig. 5). Note: Baking time can be set for any amount of time from 1 minute to 11 hours and 59 minutes.
8. Press . **"TIMED"**, **"BAKE"** and **"350°"** will remain in the display (Fig. 6).
9. Press . **"DELAY"** will flash in the display. Enter the desired start time using the number pads    (Fig. 7).
10. Press . When Delayed Time Bake starts, the set oven temperature will disappear, **"DELAY"**, **"BAKE"** and the current time of day will appear in the display (Fig. 8).
11. When the desired start time is reached, **"350°"** appears in display and **"DELAY"** disappears. Oven starts to bake at the previously selected temperature (Fig. 9).

Note: Once Delayed Time Bake has started, press  to display the bake time remaining. Once the Delayed Timed Bake has started baking, a beep will sound when the oven temperature reaches the set temperature.

Press  when baking has completed or at any time to cancel the Delayed Time Bake feature.

### When the set bake time runs out:

1. **"End"** will appear in the display and the oven will shut off automatically (Fig. 10).
2. The control will beep 3 times. The control will continue to beep 3 times every 30 seconds until  is pressed.



Fig. 1

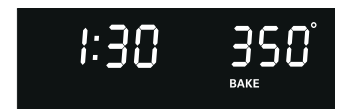

Fig. 2



Fig. 3



Fig. 4

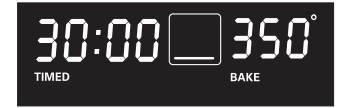

Fig. 5



Fig. 6



Fig. 7

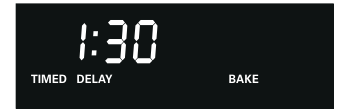

Fig. 8



Fig. 9



Fig. 10









# Setting Oven Controls (continued)

## Using the Favorite Settings Feature

The  **FAVORITE SETTING** pad is used to record and recall your favorite recipe settings. This feature may store and recall from 1 to 3 different settings. The Favorite Setting feature may be used with **Bake** or a **Timed Bake**. This feature will not work with any other function including a **Delayed Timed Bake** setting.



### INSTRUCTIONS







#### To Program the Oven to record a recipe setting and begin baking (example shown is for bake at 350°F):

- Place the food in the oven.
- Press . "BAKE" flashes and " — — — ° " appears in the display (Fig. 1)
- Within 5 seconds, press . ( Note:  or  may also be used to store a recipe setting). "BAKE" flashes, - 1- and " — — — ° " appears in the display (Fig. 2).
- Press   . " 350° " appears in the display (Fig. 3).
- Press and hold  pad for at least 3 seconds or until a beep sounds. The beep indicates that the recipe setting has been recorded for future recall. The display will show 350° and "BAKE" (Fig. 4).

**NOTE:** The oven will continue to bake unless  is pressed.

#### To Begin Baking recalled setting (example below recalling from the number 1 pad) :

- Place the food in the oven.
- Press . "BAKE" flashes and " — — — ° " appears in the display (Fig. 5).
- Within 5 seconds, press . "BAKE" flashes , "- 1-" and " 350° " appears in the display (Fig. 3).
- Press . The oven will begin to immediately cook with the previously recorded recipe (Fig. 4). The Temperature is recalled and if a Timed Bake was recorded this feature will also recall the cooking time.

Note: If you desire to keep a stored recipe but remove the cook time, press  , the  or  or  pad (the pad the recipe is stored with). Then press  , press  and then press and hold the  pad for 3 seconds.

### PRESS

### DISPLAY



Fig. 1



Fig. 2



Fig. 3



Fig. 4



Fig. 5



# Setting Oven Controls (continued)

## Setting Broil



The  pad controls the Broil feature. When broiling, heat radiates downward from the oven broiler for even coverage.

The Broil feature is preset to start broiling at 550°F; however, the Broil feature temperature may be set between 400°F and 550°F. The broil pan and broil pan insert used together allow dripping grease to drain and be kept away from the high heat of the oven broiler. **DO NOT** use the broil pan without the insert (See Fig. 5). **DO NOT cover the broil pan insert with foil.** The exposed grease could catch fire.

**⚠ WARNING** Should an oven fire occur, leave the oven door closed and turn off the oven. If the fire continues, throw baking soda on the fire or use a fire extinguisher. **DO NOT** put water or flour on the fire. Flour may be explosive and water can cause a grease fire to spread and cause personal injury.

### INSTRUCTIONS

#### To set the oven to broil at the default setting (550°F):

- Place the broiler pan insert on the broiler pan. Then place the food on the broiler pan insert. **DO NOT** use the broiler pan without the insert. **DO NOT** cover the broiler insert with foil. The exposed grease could ignite.
- Arrange the interior oven rack and place the broiler pan on the rack. Be sure to center the broiler pan directly under the broiler element. **Make sure the oven door is in the broil stop position (see Fig. 4). For optimum browning, preheat broil burner for 3-4 minutes before adding food.**
- Press . "BROIL" will flash and "550°" will appear (Fig. 1).
- If a lower broil temperature is desired (minimum broil temperature setting is 400°F), press the desired temperature before continuing to step 5.
- Press . The oven will begin to broil. "BROIL" and "550°" will appear in the display (Fig. 2).
- Broil on one side until food is browned; turn and cook on the second side. Season and serve. **Note:** Always pull the rack out to the stop position before turning or removing food.
- To cancel broiling or if finished broiling press  (Fig. 3).

### PRESS

### DISPLAY

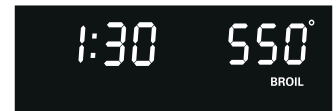

Fig. 1



Fig. 2

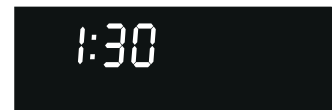
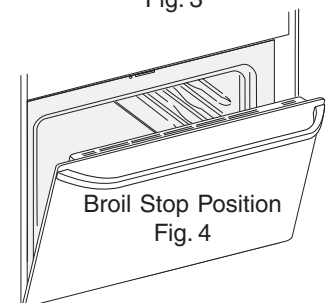

Fig. 3



Broil Stop Position  
Fig. 4

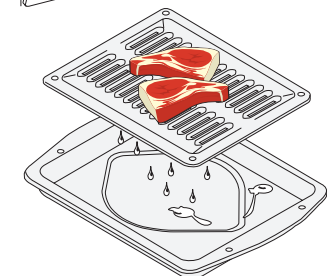

Fig. 5

### Broiling Times

Use the following table for approximate broiling times. Increase or decrease broiling times, or move the broiling pan to a different rack position to suit for doneness. If the food you are broiling is not listed in the table, follow the instructions provided in your cookbook and watch the item closely.

#### Electric and Gas Oven Broiling Table Recommendations

Food Item	Rack Position from bottom	Temp Setting	Cook Time		Doneness
			1st side	2nd side	
Steak 1" thick	3rd or 4th	550° F	6:00	4:00	Rare
	3rd or 4th	550° F	7:00	5:00	Medium
Pork Chops 3/4" thick	3rd	550° F	8:00	6:00	Well
Chicken - Bone In	2nd	450° F	20:00	10:00	Well
Chicken - Boneless	3rd	450° F	8:00	6:00	Well
Fish	3rd	500° F	13:00	n/a	Well
Shrimp	2nd	550° F	5:00	n/a	Well
Hamburger 1" thick	4th	550° F	9:00	7:00	Medium
	3rd	550° F	10:00	8:00	Well

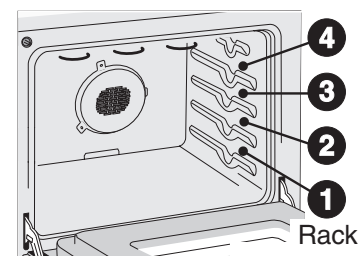



Fig. 6

Rack positions

# Setting Oven Controls (continued)

## Setting the Keep Warm Feature

The **Keep Warm**  pad turns ON the Keep Warm feature and will maintain an oven temperature of 170°F (77°C). The Keep Warm feature will keep oven baked foods warm for serving up to 3 hours after cooking has finished. After 3 hours the Keep Warm feature will shut the oven OFF. The Keep Warm feature may be used without any other cooking operations or can be used after cooking has finished using BAKE, CONVECTION BAKE or CONVECTION ROAST.

The Keep Warm feature may be used with TIMED BAKE if you wish to have the Keep Warm feature turn ON automatically when cooking has finished. The Timed Bake features require you to set start time and the amount of cooking time. With this information the control can calculate the time when cooking will complete and can then start the Keep Warm feature automatically.

### INSTRUCTIONS

### PRESS

### DISPLAY

#### To set Keep Warm





1. Arrange interior oven racks and place food in oven.
  2. Press . "Hld" will appear in the display (Fig. 1).  
Note: If no pad is touched within 25 seconds the request to turn ON Keep Warm feature will be cancelled.
  3. Press . The oven icon will appear in the display (Fig. 2).
  4. To turn the Keep Warm OFF at any time press  or .
- Note:** The Keep Warm feature will automatically turn OFF after 3 hours.



Fig. 1



Fig. 2

#### To set Keep Warm to turn ON automatically





1. Arrange interior oven racks and place food in oven. Set the oven properly for **Timed Bake or Delayed Timed Bake**.
  2. Press  (Fig. 3).  
Note: If no pad is touched within 25 seconds the request to turn ON the Keep Warm feature and all functions previously programmed will be cleared.
  3. Press . "Hld" will disappear and the temperature will be displayed (Fig. 4). The Keep Warm mode is set to turn ON automatically after Timed Bake has finished (See Fig. 1).
  4. To turn the Keep Warm feature OFF at any time press  again.
- Note:** The Keep Warm feature will automatically turn OFF after 3 hours.



Fig. 3



Fig. 4

Pressing  at any time will stop all oven baking operations.



Note: The Keep Warm feature can be turned ON or OFF at anytime without canceling Bake or any other cooking functions by pressing









#### To turn ON/OFF the Oven Light

The oven light automatically turns ON when the oven door is opened. The oven light may also be manually turned ON or OFF by pressing the  pad.

# Setting Oven Controls (continued)

## To Set the Sabbath Feature (for use on the Jewish Sabbath & Holidays)







The  **BAKE TIME** and  **START TIME** pads are used to set the Sabbath feature. The Sabbath feature may only be used with the  pad. The oven temperature may be set higher or lower after setting the Sabbath feature (the oven temperature adjustment feature should be used only during Jewish Holidays), however the display will not visibly show and no audible tones will be provided when a change occurs. Once the oven is properly set using Bake with the Sabbath feature active, the oven will remain continuously ON until cancelled. This will override the factory preset 12-Hour Energy Saving feature. If the oven light is needed during the Sabbath, press  before activating the Sabbath feature. Once the oven light is turned ON and the Sabbath feature is active, the oven light will remain ON until the Sabbath feature is turned OFF. If the oven light needs to be OFF, be sure to turn the oven light OFF before activating the Sabbath feature.

**IMPORTANT NOTES:** It is not advised to attempt to activate any other program feature except **BAKE** while the Sabbath feature is active. ONLY the following key pads will function correctly with the Sabbath feature: **0-9 number pads**,  ,  &

 **ALL OTHER KEYPADS** should not be used once the Sabbath feature is activated.

### INSTRUCTIONS

#### To Program the Oven for 350°F, Begin Baking Immediately and activate the Sabbath feature:

1. Be sure that the clock is set with the correct time of day.
2. Arrange the oven racks and place the food in the oven.
3. Press  , "- - - °" will appear in the display (Fig. 1).
3. Press    (Fig. 2). "**BAKE**" will flash and "**350°**" will appear in the display.
4. Press  . The display will show "**350°**" and "**BAKE**". The oven will turn ON and begin heating (See Fig. 3).
5. If a **Timed Bake** or **Delay Start** (Delayed Timed Bake) is needed then enter the time in this step. If not, skip this step and continue to step 6. Refer to the **Timed Bake** or **Delay Start** instructions on pages 19-20. Remember the oven will shut down after completing a **Timed Bake** or **Delay Start** and therefore may only be used once during the Sabbath/Jewish Holidays. The maximum **Delay Start** time is 11 hours & 59 minutes.
6. At the same time press and hold both the  and  pads for at least 3 seconds. The control will beep and **SAb** will appear in the display (See Fig. 4). Once **SAb** appears in the display the oven control will no longer beep or display any further changes and the oven is properly set for the Sabbath feature.

### PRESS

### DISPLAY



Fig. 1





Fig. 2





Fig. 3



Fig. 4

**Note:** You may change the oven temperature once baking has started. Press  , enter the oven temperature change (170 to 550F°) and press  twice (for Jewish Holidays only). Remember that **the oven control will no longer beep or display any further changes** once the oven is set for the Sabbath feature.

7. The oven may be turned OFF at any time by pressing  pad (this will turn the oven OFF only). To turn OFF the Sabbath feature press and hold at the same time both the  and  pads for at least 3 seconds. **SAb** will disappear from the display.





---

## Setting Oven Controls (continued)

### To Set the Sabbath Feature (for use on the Jewish Sabbath & Holidays)

It is recommended that any oven temperature change with the Sabbath feature activated be followed with 2 presses of the **START** pad. This will insure the oven remains ON even if the attempt to set the oven temperature was lower or higher than the oven control can accept. If the oven temperature is set incorrectly, the oven temperature will default to 170°F or 550°F. Try to set the desired oven temperature again.







Should you experience a power failure or interruption, the oven will shut off. When power is returned the oven will not turn back on automatically. The oven will remember that it is set for the Sabbath and the food may be safely removed from the oven while still in the Sabbath feature, however the oven cannot be turned back on until after the Sabbath/Holidays. After the Sabbath

observance turn OFF the Sabbath feature. At the same time press and hold both the  and  pads for at least 3 seconds. **SAb** will disappear from the display and the oven may be used with all normal functions. For further assistance, guidelines for proper usage, and a complete list of models with the Sabbath feature, please visit the web at <http://www.star-k.org>.



# Oven Cleaning

## Self-Clean Cycle Time Length

The **SPEED CLEAN** , **CLEAN**  and **MAXX CLEAN**  pads control the Self-Cleaning feature. If you are planning to use the oven directly after a self-clean cycle remember to allow time for the oven to cool down and the oven door to unlock. This normally takes about one hour. So a 3 hour self-clean cycle will actually take about 4 hours to complete. \*It is recommend to use a  cycle (2 hour) for **light soils**, a  cycle (3 hour) for **average soils**, and a  cycle (4 hour) for **heavy soils** (to assure satisfactory results).

**NOTE:** A smoke eliminator in the oven vent converts most of the soil into a colorless vapor.

**⚠ WARNING** During the Self-Cleaning cycle, the outside of the range can become very hot to touch. **DO NOT** leave small children unattended near the appliance.

**⚠ CAUTION** To avoid possible burns use care when opening the oven door after the Self-Cleaning cycle. Stand to the side of the oven when opening the door to allow hot air or steam to escape.

**⚠ CAUTION** **DO NOT** force the oven door open. This can damage the automatic door locking system. Use caution and avoid possible burns when opening the door after the Self-Cleaning cycle has completed. The oven may still be VERY HOT.

### INSTRUCTIONS

### PRESS

### DISPLAY

**To start an immediate Self-Cleaning cycle or to set a delay start time of 4:30 and shut of automatically (example provided is a default 3 hour Self-Clean cycle):**





1. Be sure the clock is set with the correct time of day, the oven is empty and the oven door is closed.
2. Press . "**CLEAN**" will flash and "**3:00**" HR will show in the display (Fig. 1). The control will automatically clean for a 3 hour period (default self-cleaning cycle time). Note: If a 2 or 4 hour clean time is desired, press  for 2 hour or press  for a 4 hour clean time. Set the cleaning time based on the amount of soil: light, medium or heavy (\* See above).
3. Press . The "**DOOR LOCKED**" icon will flash; "**CLEAN**" icon and the letters "**CLn**" will remain on in the display (Fig. 2).
4. As soon as the control is set, the motor driven oven door lock will begin to close automatically. Once the door has been locked the "**DOOR LOCKED**" indicator light will stop flashing and remain on. Also, the oven icon will appear in the display (Fig. 3).



Fig. 1



Fig. 2



Fig. 3

Note: Allow about 15 seconds for the oven door lock to close.

**NOTE:** If the optional delay Self-Clean feature is needed, finish steps 5-7. If Self-Clean is started immediately skip the remaining steps and continue with "When the Self-Clean cycle is done" on the following page.





5. Press . Enter the desired start time using the number pads    (Fig. 4).
6. Press . The "**CLn**" icon will turn off; "**DELAY**", "**DOOR LOCKED**" and "**CLEAN**" icons will remain on (Fig. 5).
7. The control will start the self-cleaning at the set start time, for the period of time previously selected. At that time, the icon "**DELAY**" will go out; "**CLn**" and oven icon will appear in the display (Fig. 6).



Fig. 4



Fig. 5



Fig. 6

# Oven Cleaning (continued)

## INSTRUCTIONS

## PRESS

## DISPLAY

### When the Self-Clean Cycle is Completed

1. The time of day, "END", "DOOR LOCKED" and "CLEAN" will remain in the display.
2. Once the oven has cooled down for approximately 1 HOUR, and "DOOR LOCKED" is no longer displayed, the oven door can then be opened.

### Stopping or Interrupting a Self-Cleaning Cycle

If it becomes necessary to stop or interrupt a self-cleaning cycle due to excessive smoke or fire in the oven:

1. Press .
2. The oven door can only be opened after the oven has cooled down for approximately 1 HOUR and "DOOR LOCKED" is no longer displayed (Fig. 1).

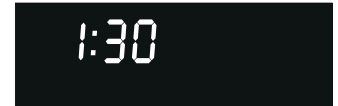

Fig. 1

### IMPORTANT NOTES when using the Self-Clean feature:

1. On some models, the Self-Clean feature will not operate whenever a radiant surface remains ON.
2. On some models, starting a self-clean cycle will turn ON the Cooktop Lockout feature. If it is the case the symbol  will appear in the display (Fig. 2) which will indicate that the Cooktop Lockout feature is ON. The cooktop will remain locked until the Self-Clean cycle has completed and the oven door has unlocked.
3. A Self-Clean cycle cannot be started if Oven Lockout feature is active.
4. If a Self-Cleaning Cycle has started but not finished and a power failure occurs, the appliance may not have thoroughly cleaned. Once power is restored, the oven door and the cooktop are unlocked. Then set for another Self-Clean cycle to finish.
5. If your clock is set for normal 12 hour display mode the Delay Self-Clean cycle can never be set to start more than 12 hours in advance. To set for a delayed Self-Cleaning cycle 12-24 hours in advance set the control for the 24 hour time of day display mode.



Fig. 2





# Adjusting Oven Temperature

The temperature in the oven has been preset at the factory. When first using the oven, be sure to follow recipe times and temperatures. If you think the oven is cooking too hot or too cool for the temperature you select, you can adjust the actual oven temperature to be more or less than what is displayed. Before adjusting, test a recipe by using a temperature setting that is higher or lower than the recommended temperature. The baking results should help you to decide how much of an adjustment is needed.







**Note:** The oven temperature adjustments made with this feature will not change the Self-Clean cycle temperature or the Broil temperature .

## INSTRUCTIONS

### To adjust the oven temperature higher

1. Press  for 6 seconds. 0° will appear in the display (Fig. 1).
2. To increase the temperature use the number pads to enter the desired change (Example 30°F)   (Fig. 2). The temperature may be increased by as much as 35°F (19°C).
3. Press  to accept the temperature change and the display will return to the time of day (Fig. 3). Press  to reject the change if necessary.

### To adjust the oven temperature lower

1. Press  for 6 seconds. 0° will appear in the display (Fig. 4).
2. To decrease the temperature use the number pads to enter the desired change. (Example -30°F)   and then press  (Fig. 5). The temperature may be decreased by as much as 35°F (19°C).
3. Press  to accept the temperature change and the display will return to the time of day (Fig. 6). Press  to reject the change if necessary.

## PRESS



## DISPLAY



Fig. 1



Fig. 2



Fig. 3



Fig. 4



Fig. 5



Fig. 6

# PROGRAMMATEUR ÉLECTRONIQUE DU FOUR

## Fonctions des touches de commande

Lisez attentivement ces instructions avant d'utiliser le four. Pour obtenir des résultats satisfaisants de votre four, il est important de bien connaître les fonctions du programmateur électronique décrites ci-dessous. **Note:** Le graphisme sur votre programmateur peut ne pas être identique à celui illustré dans ce guide. Ceci ne change aucunement son mode de fonctionnement.

**Nettoyage Speed**— Sélectionne le cycle autonettoyant de 2 heures.

**Lampe du four**— Allume et éteint la lampe du four

**Minuterie**— Règle et annule toutes les fonctions de la minuterie.

**Heure de Départ**— Utilisée avec **Cuire, Temps de cuisson et Nettoyer** pour programmer un temps différé pour la cuisson ou le nettoyage.

**Cuire- Sélectionne le mode de cuisson normale.**

**Griller-** Sélectionne la cuisson au grill.

**Garder chaud**— Sélectionne le mode garder chaud.

**Touches numériques 0 à 9**— Utilisées pour entrer la température et l'heure.

**Nettoyer-** Sélectionne le cycle autonettoyant de 3 heures.

**Temps de cuisson-** Programme le temps de cuisson au four.

**Horloge**— Utilisée pour régler l'heure.

**Nettoyage maxx** — Sélectionne le cycle autonettoyant de 4 heures.

**Verrou controls** — Active ou désactive toutes les fonctions du four et verrouille la porte du four.

**Conv convert** — Convertit le mode de cuisson en mode de cuisson à convection.

**Rôtissage à convection-** Sélectionne le mode de rôtissage par convection.

**Annuler**— Annule toutes les fonctions pré-sélectionnées sauf l'heure et la minuterie.

**Départ-** Démarre toutes les fonctions du four sauf, la lampe du four.

**Préféré**—Rappelle les recettes entrées en mémoire.

**Cuisson à convection-** Sélectionne le mode de cuisson au four par convection.

**Even Cook** ···  
**Convection Oven**  
Four à convection à cuisson égale

Nettoyage Speed clean  
Lampe  
Timer On/Off Minuterie  
Clean Nettoyer  
Bake time Temps de cuisson  
Start time Heure de départ  
Nettoyage Maxx clean  
Clock Horloge  
Lock Verrou Controls  
Bake Cuire  
Broil Griller  
Keep warm Garder chaud  
Conv Convert  
Conv bake Cuisson à conv  
Conv roast Rôtissage à conv  
Favorite Préféré  
Clear/Off Annuler  
START DÉPART

## Valeurs minimales et maximales selon les caractéristiques

Toutes les caractéristiques présentées ont des valeurs minimales et maximales de durée ou de température qui peuvent être entrées. Un bip d'acceptation de l'ENTRÉE retentit chaque fois que vous appuyez sur une touche (la touche de verrouillage du four est retardée de 3 secondes).

Un signal (trois bips courts) d'ERREUR D'ENTRÉE retentit si l'entrée d'une température ou d'une durée est inférieure à la valeur minimale ou supérieure à la valeur maximale de la fonction choisie.

FONCTION		TEMPÉRATURE/ TEMPS MINIMUM	TEMPÉRATURE/ TEMPS MAXIMUM
Température de cuisson		170°F/77°C	550°F/288°C
Température de grill		400°F/205°C	550°F/288°C
Minuterie	12 heures	0:01 mn	11:59 h/mn
	24 heures	0:01 mn	11:59 h/mn
Horloge	12 heures	1:00 h/mn	12:59 h/mn
	24 heures	0:00 h/mn	23:59 h/mn
Temps de cuisson	12 heures	0:01 mn	11:59 h/mn
	24 heures	0:01 mn	11:59 h/mn
Heure de mise en marche	12 heures	1:00 h/mn	12:59 h/mn
	24 heures	0:00 h/mn	23:59 h/mn
Cuisson à convection		325°F/163°C	550°F/288°C
Rôtissage à convection		325°F/163°C	550°F/288°C

## Réglage de l'horloge

La touche  est utilisée pour régler l'horloge. L'horloge peut être réglée pour fonctionner en mode 12 ou 24 heures. Elle a cependant été programmée en usine pour fonctionner en mode 12 heures. Lorsque l'appareil est branché pour la première fois ou chaque fois qu'il est réalimenté après une interruption, l'écran clignote et **PF** (power failure) apparaît à l'écran (Fig. 1).

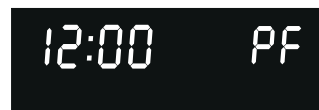





Fig. 1

Lorsque **PF** apparaît à l'écran, appuyez sur la touche . **PF** disparaîtra dans 10 secondes.







### INSTRUCTIONS

#### Réglage de l'horloge (exemple 1:30)

1. Appuyez sur la touche . "**CLO**" apparaît (Fig. 2).
2. Appuyez sur les touches    pour régler l'heure à 1:30 (Fig. 3).

Appuyez sur la touche . "**CLO**" disparaît et l'horloge se met en marche (Fig. 4).

#### Pour changer l'affichage en mode 12 heures ou 24 heures

1. Appuyez sur la touche  et maintenez-la enfoncée pendant 7 secondes (Fig. 3). Après 7 secondes, "**12Hr**" (Fig. 5) ou "**24Hr**" (Fig. 6) apparaît à l'écran et un signal sonore se fait entendre.
2. Appuyez sur la touche  pour changer l'affichage de 12 à 24 heures. L'écran affiche soit "**12Hr**" (Fig. 5) ou "**24Hr**" (Fig. 6).
3. Appuyez sur la touche  pour accepter le changement ou sur   OU  pour l'annuler.
4. Réajustez l'horloge à l'heure exacte comme décrit à la section "**Réglage de l'horloge**". Veuillez noter que si le mode d'affichage 24 heures est sélectionné, l'horloge affiche l'heure de 0:00 à 23:59 heures.

### APPUYEZ

### ÉCRAN



Fig. 2

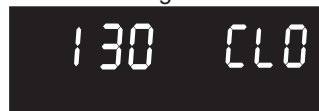

Fig. 3



Fig. 4





Fig. 5









Fig. 6

## Affichage de la température — Fahrenheit ou Celsius

Les touches  et  contrôlent l'affichage de la température. Le programmeur électronique peut être réglé pour afficher la température en degrés Fahrenheit ou Celsius. Votre appareil a été programmé en usine pour afficher la température en degrés Fahrenheit.

### INSTRUCTIONS

#### Pour changer l'affichage de Fahrenheit à Celsius ou de Celsius à Fahrenheit

1. Pour savoir si l'appareil affiche la température en degrés Fahrenheit ou en degrés Celsius, appuyez sur la touche  (Fig. 7) et maintenez-la enfoncée pendant 7 secondes; "**550°**" apparaît, "**BROIL**" clignote à l'écran et un signal sonore se fait entendre. Si "**F**" apparaît, le programmeur est réglé pour afficher la température en degrés Fahrenheit (Fig. 8). Si "**C**" apparaît, le programmeur est réglé pour afficher la température en degrés Celsius (Fig. 9).
2. Appuyez sur la touche  pour changer entre l'affichage en degrés Fahrenheit ("**F**") ou en degrés Celsius ("**C**") (Fig. 8 ou Fig. 9).
3. Appuyez sur la touche  pour accepter le changement ou sur   OU  pour l'annuler.

### APPUYEZ

### ÉCRAN



Fig. 7

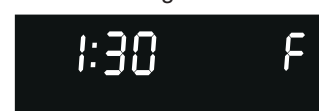

Fig. 8

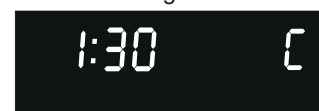



Fig. 9





## Réglage de l'horloge (suite)

### Cuisson continue ou arrêt automatique après 12 heures

Les touches  et  contrôlent la cuisson continue. L'appareil a la capacité de fonctionner en continu mais comme mesure d'économie d'énergie, le programmeur électronique du four a été programmé à l'usine pour couper automatiquement l'alimentation électrique après 11 heures et 59 minutes de fonctionnement continu.

#### INSTRUCTIONS

#### Pour régler le programmeur pour une cuisson continue ou un arrêt automatique après 12 heures

1. Appuyez sur la touche  et maintenez-la enfoncée pendant 7 secondes (Fig. 1). Après 7 secondes, "12Hr" ou "- - Hr" apparaît à l'écran et un signal sonore se fait entendre.
2. Appuyez sur la touche  pour passer du mode arrêt automatique après 12 heures au mode de cuisson continu. Note: "12Hr" (Fig. 2) apparaissant à l'écran indique que le programmeur est en mode "Économie d'énergie" tandis que "- - Hr" (Fig. 3) indique que le programmeur est en mode "Cuisson continue".
3. Appuyez sur la touche  pour accepter le changement (Fig. 4; l'écran affiche l'heure du jour) ou appuyez sur la touche  pour annuler le changement.

#### APPUYEZ

 pendant 7 secondes







#### ÉCRAN



Fig. 1



Fig. 2



Fig. 3







Fig. 4

## Minuterie

La touche  contrôle la minuterie. Il s'agit d'une minuterie supplémentaire qui émet un signal sonore lorsque le temps programmé est écoulé. Elle peut être utilisée en tout temps, quelle que soit la fonction de cuisson déjà engagée; elle peut être réglée pour n'importe quelle durée, de 1 minute à 11 heures 59 minutes en mode 12 ou 24 heures.

#### INSTRUCTIONS

#### Pour régler la minuterie (exemple 5 minutes)

1. Appuyez sur la touche  "0:00" apparaît et "TIMER" clignote (Fig. 5).
2. Appuyez sur les touches numériques pour afficher le temps désiré (exemple ). Appuyez sur la touche . La minuterie se met en marche. "5:00" et "TIMER" restent affichés (Fig. 6). **Note:** Si vous n'appuyez pas sur  dans les 25 secondes qui suivent, la minuterie revient à l'heure du jour.
3. Une fois le temps écoulé, "End" apparaît et "TIMER" reste affiché à l'écran (Fig. 7). 3 signaux sonores se font entendre toutes les 7 secondes ou jusqu'à ce que vous appuyiez sur la touche .

#### APPUYEZ









#### ÉCRAN



Fig. 5



Fig. 6



Fig. 7

#### Pour annuler le réglage de la minuterie avant que le temps soit écoulé

Appuyez sur la touche . L'écran retourne à l'heure du jour.



# Caractéristiques du programmeur

Note: Les caractéristiques du programmeur sont des ajustements du programmeur qui n'affectent pas les fonctions de cuisson de ce dernier. Ceux-ci incluent les fonctions verrouillage, tableau de commande silencieux et affichage de la température.

## Verrouillage

La touche  contrôle la fonction "verrouillage". Cette caractéristique verrouille la porte du four et empêche que ce dernier s'allume accidentellement. Cette caractéristique ne désactive pas l'horloge, la minuterie et l'interrupteur de la lampe du four.

### INSTRUCTIONS

#### Pour activer la minuterie

1. Appuyez sur la touche  et maintenez-la pendant 3 secondes.
2. Après 3 secondes, un signal sonore se fait entendre, "**LOC**" apparaît et "**DOOR LOCKED**" clignote à l'écran (Fig. 1). Une fois la porte verrouillée "**DOOR LOCKED**" arrête de clignoter.

### APPUYEZ

 pendant 3 secondes

### ÉCRAN



Fig. 1

#### Pour réactiver la fonction normale du four:



1. Appuyez sur la touche  et maintenez-la pendant 3 secondes. Un signal sonore se fera entendre. "**LOC**" disparaît et "**DOOR LOCKED**" clignote à l'écran jusqu'à ce que la porte soit complètement déverrouillée (Fig. 2).
2. Le four peut alors être utilisé.

 pendant 3 secondes





Fig. 2

## Tableau de commande silencieux

Les touches  et  contrôlent la fonction "tableau de commande silencieux". Cette caractéristique permet d'empêcher les commandes d'émettre un signal sonore lors de leurs utilisations. Si vous le désirez, vous pouvez programmer les commandes pour qu'elles fonctionnent silencieusement ou pour entendre les signaux sonores.

### INSTRUCTIONS

#### Pour changer le tableau de commande pour qu'il soit silencieux:

1. Pour savoir si votre appareil est programmé pour émettre des signaux sonores ou pour être silencieux, appuyez sur la touche  et maintenez-la enfoncée pendant 7 secondes. "**0:00**" apparaît et "**DELAY**" clignote (Fig. 3). Après 7 secondes "**:SP**" apparaît à l'écran (Fig. 4).
2. Appuyez sur la touche  pour passer du mode sonore au mode silencieux. L'écran affichera soit "**:SP**" (Fig. 4) ou "**:--**" (Fig. 5).  
Si "**:SP**" est affiché (Fig. 4), le programmeur est en mode sonore. Si "**:--**" apparaît (Fig. 5), le programmeur est en mode silencieux.

### APPUYEZ

 pendant 7 secondes

### ÉCRAN





Fig. 3



Fig. 4



Fig. 5

3. Appuyez sur la touche  pour accepter le changement ou sur  pour l'annuler.

 OU 







# Réglage du programmateur électronique

## Régler la Cuisson

La touche  contrôle le mode de cuisson normal. Le four peut être programmé pour la cuisson à des températures allant de 170°F à 550°F (77°C à 288°C).





### INSTRUCTIONS

#### Pour régler la température de cuisson à 350°F

1. Placez les grilles du four aux positions voulues et les plats à cuisiner dans le four.
2. Appuyez sur la touche , "--- °" apparaît et "BAKE" clignote à l'écran (Fig. 1).
3. Appuyez sur les touches   . "BAKE" clignote et "350°" apparaît à l'écran (Fig. 2).
4. Appuyez sur la touche . Un signal sonore se fait entendre lorsque la température atteint 350° F et l'écran affiche "350°" et "BAKE" (Fig. 3).

Appuyez sur la touche  pour arrêter ou annuler la cuisson en tout temps.

#### Pour changer la température de cuisson (exemple changer de 350° à 425°F)

1. Si la température déjà programmée à 350°F doit être changée pour 425°F, appuyez sur  (Fig. 4). "--- °" apparaît et "BAKE" clignote à l'écran.
2. Appuyez sur les touches    (Fig. 5). "BAKE" continue de clignoter et "425°" apparaît à l'écran (Fig. 5).
3. Appuyez sur la touche . "BAKE" arrête de clignoter et "425°" reste affiché à l'écran (Fig. 6).

Note: Si le four à récemment été utilisé et est encore chaud, il est probable que l'icône de l'élément de cuisson de l'écran (petite ligne dans le carré) n'apparaisse pas tout de suite à l'écran.

### APPUYEZ

### ÉCRAN



Fig. 1



Fig. 2



Fig. 3



Fig. 4



Fig. 5



Fig. 6



# Réglage du programmateur électronique (suite)

## Cuisson par convection

La touche  contrôle la cuisson par convection. En mode convection, le four peut être programmé à des températures allant de 325°F (163°C) à 550°F (288°C). Le mode Cuisson par convection utilise un ventilateur qui fait circuler la chaleur afin d'obtenir une température égale et continue à l'intérieur du four. Cette distribution de la chaleur permet de faire cuire et de faire dorer les aliments de façon homogène et plus rapidement. Ce mode de cuisson permet aussi d'avoir de meilleurs résultats de cuisson lors de l'utilisation de 2 ou 3 grilles en même temps. Les pains et les pâtes dorent de façon plus homogène. La cuisson par convection cuit la plupart des aliments plus rapidement et de manière plus homogène que la cuisson conventionnelle.

### Instructions générales pour la cuisson par convection

1. Lors de l'utilisation de la cuisson par convection, diminuez vos durées normales de cuisson comme il est indiqué dans le tableau à côté. Réglez la durée de cuisson selon le degré souhaité. Les réductions de durée varient selon la quantité et le type d'aliment à cuire. Les gâteaux secs et biscuits doivent être cuits sur des tôles à biscuits sans côtés ou avec des côtés très bas, pour permettre à l'air chaud de circuler tout autour d'eux. Les aliments cuits sur des ustensiles avec un fini de couleur foncée vont cuire plus rapidement.
2. Le préchauffage n'est pas nécessaire lors de la cuisson de plats mijotés en utilisant la convection.
3. Lors de la cuisson avec convection sur une seule grille, placez la grille du four à la position 2 ou 3. Pour une cuisson sur plusieurs grilles, placez les grilles aux positions 2 et 3.

### Avantages de la cuisson par convection:

- Certains aliments cuisent de 25% à 30% plus rapidement.
- Possibilité de cuisson sur plusieurs grilles.
- Aucun ustensiles ni plats spéciaux ne sont nécessaires.

### Lors de la cuisson avec convection

#### \*Diminuez la durée normale de cuisson de:





Aliments, tartes	
pâtisserie et pizzas surgelés ..	15-25%
Gâteaux secs réfrigérés .....	15-35%
Biscuits réfrigérés .....	15-30%
Petits pains .....	20-25%
Pâtisserie et tartes fraîches ....	10-20%

Commencez par la réduction maximale des durées de cuisson et ajustez au besoin.

\* Réduction recommandée des durées de cuisson, basée sur les marques d'aliment ayant fait l'objet du test. Les durées de cuisson peuvent varier selon les marques.

### INSTRUCTIONS

#### Pour régler la température d'une cuisson par convection à 350°F

1. Placez les grilles du four aux positions voulues et les plats à cuisiner dans le four.
2. Appuyez sur la touche . "CONV BAKE" clignote et "---" apparaît à l'écran (Fig. 1).
3. Appuyez sur les touches   . "CONV BAKE" et "350°" apparaissent à l'écran (Fig. 2).
4. Appuyez sur la touche . "CONV BAKE" et la température ajustée apparaissent à l'écran (pour l'exemple présent, l'écran affiche 325°C). Un signal sonore se fait entendre une fois la température programmée atteinte. L'écran affiche alors "325°", "CONV BAKE" et l'icône du ventilateur (Fig. 3)

**Note:** Le ventilateur convection se met en marche aussitôt que le programmateur est réglé pour une cuisson par convection. L'icône du four tourne pour indiquer que le ventilateur convection fonctionne.

Appuyez sur la touche  pour arrêter ou pour annuler la cuisson par convection à tout moment.

**Note:** Aussitôt que la touche  est activée la température désirée est réduite de 25°F (13°C).

### APPUYEZ

### ÉCRAN



Fig. 1



Fig. 2



Fig. 3





# Réglage du programmateur électronique (suite)

## Rôtissage par convection

La touche  contrôle la fonction Rôtissage par convection. Cette fonction combine un cycle de cuisson avec un ventilateur et un élément convection afin de rôtir les viandes et volaille. Le préchauffage n'est pas nécessaire pour les viandes et la volaille. L'air chaud circule tout autour de l'aliment scellant son jus et sa saveur. Les aliments sont dorés et croustillants à l'extérieur tout en restant juteux à l'intérieur.

### INSTRUCTIONS

#### Pour régler le four pour une cuisson par rôtissage à convection (exemple: Cuire de la viande à 350°F)

1. Placez les grilles du four aux positions voulues et placez ensuite la nourriture dans le four.
2. Appuyez sur la touche . "CONV" clignote et "---°" apparaît à l'écran (Fig. 1).
3. Appuyez sur les touches   . "CONV" clignote et "350°" apparaît à l'écran (Fig. 2).
4. Appuyez sur la touche . "CONV", "350°" et l'icône ventilateur apparaissent à l'écran (Fig. 3).

Appuyez sur la touche  pour arrêter la cuisson par convection ou pour annuler la fonction à tout moment.

#### Instructions pour la grille de rôtissage (certains modèles)

Lorsque vous préparez des viandes pour le rôtissage à convection, utilisez la lèchefrite et sa grille en même temps que la grille de rôtissage (si fournie). La lèchefrite recueille les écoulements de graisse et sa grille empêche les éclaboussures de graisse. La grille de rôtissage permet à la chaleur de circuler autour de la viande.

**⚠ AVERTISSEMENT** Pour empêcher l'aliment de toucher l'élément de grilloir et pour empêcher les éclaboussures, **N'utilisez PAS** de grille de rôtissage pour cuire avec l'élément de grilloir.

1. Placez la grille du four au fond ou près de la position la plus basse dans le four.
2. Placez la grille dans la lèchefrite. La grille de rôtissage s'adapte sur la grille de lèchefrite en permettant à l'air chaud de circuler sous l'aliment pour une cuisson uniforme et pour mieux brunir le dessous. Assurez-vous que la grille de rôtissage est bien installée sur la grille de lèchefrite. **NE** vous servez **PAS** de la lèchefrite sans sa grille. **NE** recouvrez **PAS** de papier d'aluminium la grille de la lèchefrite.
3. Placez la nourriture (graisse vers le haut) sur la grille de rôtissage (Fig. 4).
4. Placez la lèchefrite sur la grille du four.

### APPUYEZ

### ÉCRAN









Fig. 1



Fig. 2



Fig. 3

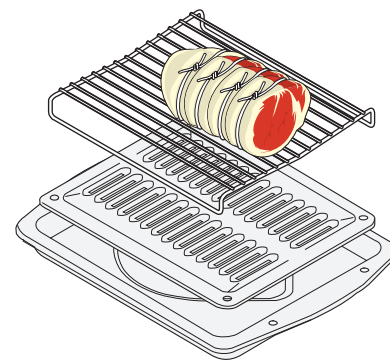



Fig. 4

## Réglage du programmateur électronique (suite)

### Fonction "Conversion à la convection" (convection convert)

La touche  est utilisée pour convertir automatiquement une recette pour la **cuisson standard** en cuisson par convection.





Lorsque cette fonction est utilisée adéquatement, elle affiche à l'écran la température (réduite) de conversion.

Cette fonction peut être utilisée **SEULEMENT** avec les modes **Cuisson**, **Cuisson minutée** ou **départ différé**. Lorsque celle-ci est utilisée avec une cuisson minutée ou un départ différé, l'écran affiche "**CF**" (pour **C**heck **F**ood) lorsque le temps de cuisson est écoulé à 75% (voir Fig. 4). À ce moment le programmateur émet 3 longs signaux sonores à intervalles réguliers jusqu'à ce que la cuisson soit terminée. Une fois le temps de cuisson dépassé, le programmateur affiche "**End**" et 3 longs signaux

sonores se font entendre jusqu'à ce que vous appuyiez sur la touche  (Fig. 5).

#### INSTRUCTIONS

#### Pour régler la fonction "Convection Convert" (cuisson) pour que le programmateur ajuste la température automatiquement (exemple: Régler le four à 350°F)

1. Placez les grilles du four aux positions voulues et placez ensuite la nourriture dans le four.
2. Appuyez sur la touche , "--- °" apparaît (Fig. 1).
3. Appuyez sur les touches   . "**BAKE**" clignote et "**350°**" apparaît à l'écran (Fig. 2). Si une cuisson minutée ou un départ différé est désirée, réglez le programmateur maintenant.
4. Appuyez sur la touche . "**CONV BAKE**" et la **température ajustée** apparaissent à l'écran (exemple 325°F). Un signal sonore se fait entendre lorsque la température ajustée est atteinte. L'écran affiche "**325°**", "**CONV BAKE**" et l'icône du ventilateur (Fig. 3).

Note: L'icône du four montre un ventilateur qui tourne à l'intérieur d'un carré. Ceci indique que le ventilateur convection est en opération (voir la Fig. 3).

Appuyez sur la touche  pour annuler la fonction "Convection Convert" à tout moment.

**Note:** La durée minimale de cuisson pouvant utiliser la fonction Convection Convert lors d'une cuisson minutée ou d'un départ différé est de 20 minutes.

#### APPUYEZ

#### ÉCRAN



Fig. 1



Fig. 2



Fig. 3







Fig. 4



Fig. 5

# Réglage du programmateur électronique (suite)

## Cuisson minutée, cuisson par convection minutée ou cuisson par rôtissage minutée









Les touches  ou  ou  et  contrôlent la fonction Cuisson Minutée. Le programmateur éteint le four automatiquement lorsque la durée de cuisson désirée est écoulée.

### INSTRUCTIONS

### APPUYEZ

### ÉCRAN

#### Pour régler le four pour qu'il commence la cuisson immédiatement et l'arrête automatiquement (exemple: cuisson à 350° pendant 30 minutes)

1. Assurez-vous que l'horloge est à l'heure juste.
2. Placez les grilles du four aux positions voulues et les plats à cuisiner dans le four.
3. Appuyez sur la touche , "- - - °" apparaît et "BAKE" clignote à l'écran (Fig. 1).
4. Appuyez sur les touches    (Fig. 2). "BAKE" continue de clignoter et "350°" apparaît à l'écran.
5. Appuyez sur la touche . "BAKE" et "350°" demeurent à l'écran (Fig. 3).
6. Appuyez sur la touche . "TIMED" clignote; "BAKE", "0:00" et "350°" apparaissent à l'écran (Fig. 4).
7. Entrez le temps de cuisson désiré à l'aide des touches numériques  . "TIMED" continue de clignoter et "BAKE", "30:00" et "350°" demeurent à l'écran (Fig. 5). Note: Le programmateur électronique peut être réglé pour n'importe quel temps de cuisson entre 1 minute et 11 heures et 59 minutes.
8. Appuyez sur la touche . "TIMED" et "BAKE" reste affichés à l'écran (Fig. 6). Lorsque la cuisson débute, l'heure courante réapparaît à l'écran.

**Note:** Lorsque la fonction cuisson minutée est en marche, appuyez sur la touche  pour connaître le temps de cuisson restant. Une fois la cuisson débutée, un signal sonore se fait entendre lorsque la température désirée est atteinte.

Appuyez sur la touche  lorsque vous voulez annuler la fonction de cuisson minutée ou lorsqu'elle est terminée.

#### Lorsque le temps de cuisson programmé est écoulé:

1. "End", "TIMED", "BAKE" et l'heure du jour apparaissent à l'écran et le four s'arrête automatiquement (Fig. 7).
2. Le programmateur émet 3 signaux sonores. Par la suite, il continue d'émettre des signaux sonores à toutes les 30 secondes

jusqu'à ce que vous appuyiez sur la touche .

**NOTE:** Rappelez-vous que la température minimale de cuisson normale est de 170°F et que celle de cuisson par convection et de rôtissage par convection est de 325°F.

**⚠ ATTENTION** Faites preuve de prudence en utilisant les modes **cuisson minutée** (Timed Bake) et **cuisson différée** (Delayed Timed Bake). Choisissez la cuisson automatique pour faire cuire la viande fumée ou congelée ainsi que la plupart des fruits et légumes. Les aliments qui se gâtent facilement comme le lait, les oeufs, le poisson, la viande ou la volaille, doivent d'abord être réfrigérés. Même lorsqu'ils sont refroidis, ils ne doivent pas rester dans le four plus de 1 heure avant le début de la cuisson et doivent être rapidement retirés lorsque la cuisson est terminée. L'ingestion d'aliments gâtés peut rendre malade par empoisonnement alimentaire.



Fig. 1



Fig. 2



Fig. 3



Fig. 4



Fig. 5



Fig. 6



Fig. 7

# Réglage du programmateur électronique (suite)

## Départ différé de la cuisson minutée, de la cuisson par convection minutée ou de la cuisson par rôtissage minutée

Les touches  ou  ou ,  et  contrôlent la fonction Départ Différé. Le programmateur met en















marche et éteint le four à l'heure sélectionnée. **NOTE:** Si votre horloge est programmée pour un affichage de 12 heures, la fonction de départ différé de cuisson ne peut pas être programmée pour plus que 12 heures à l'avance. Pour programmer le départ différé entre 12-24 heures à l'avance, réglez l'affichage en mode 24 heures.

### INSTRUCTIONS

### APPUYEZ

### ÉCRAN

#### Pour régler le four pour un départ différé et un arrêt automatique (Par exemple: cuisson à 350°F de 30 minutes qui débute à 5:30)

1. Assurez-vous que l'horloge indique l'heure juste.
2. Placez les grilles du four aux positions voulues et les plats à cuisiner dans le four.
3. Appuyez sur la touche . "- - -" apparaît et "BAKE" clignote à l'écran (Fig. 1).
4. Appuyez sur les touches    (Fig. 2). "BAKE" continue de clignoter et "350°" apparaît à l'écran.
5. Appuyez sur la touche . "BAKE" et "350°" demeurent à l'écran (Fig. 3).
6. Appuyez sur la touche . "TIMED" clignote, "0:00" apparaît et "BAKE" et "350°" demeurent à l'écran (Fig. 4).
7. Entrez le temps de cuisson désiré à l'aide des touches numériques  . "TIMED" continue de clignoter; "BAKE", "30:00" et "350°" apparaissent à l'écran (Fig. 5). Note: Le programmateur électronique peut être réglé pour n'importe quel temps de cuisson entre 1 minute et 11 heures et 59 minutes.
8. Appuyez sur la touche . "TIMED", "BAKE" et "350°" restent affichés à l'écran (Fig. 6).
9. Appuyez sur la touche . "DELAY" clignote à l'écran. Entrez l'heure à laquelle vous voulez que la cuisson débute à l'aide des touches numériques    (Fig. 7).
10. Appuyez sur la touche . Lorsque la fonction départ différé démarre, la température programmée disparaît, "DELAY", "BAKE" et l'heure du jour apparaissent à l'écran (Fig. 8).
11. À l'heure programmée pour la cuisson, "350°" apparaît et "DELAY" disparaît. Le four commence la cuisson à la température préalablement programmée (Fig. 9).

Note: Une fois la cuisson en opération, appuyez sur la touche  pour voir combien de temps il reste à la cuisson. Un signal sonore se fait entendre lorsque le four a atteint la température programmée.

Appuyez sur la touche  lorsque vous voulez annuler la fonction de départ différé ou lorsqu'elle est terminée.

#### Lorsque le temps de cuisson programmé est écoulé:

1. "End" apparaît et le four arrête automatiquement. (Fig. 10).
2. Le programmateur émet 3 signaux sonores. Il émet ensuite des signaux sonores à toutes les 30 secondes jusqu'à ce que vous

appuyez sur la touche .

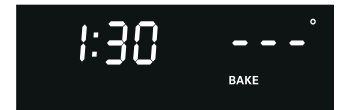

Fig. 1

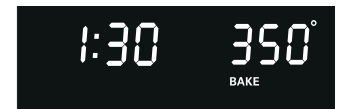

Fig. 2



Fig. 3



Fig. 4

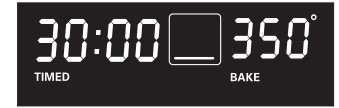

Fig. 5



Fig. 6



Fig. 7

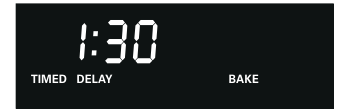

Fig. 8



Fig. 9



Fig. 10











# Réglage du programmateur électronique (suite)

## Utilisation de la caractéristique des réglages préférés

La touche  FAVORITE SETTING (réglage préféré) est utilisée pour enregistrer et rappeler les réglages de votre recette préférée. Cette caractéristique peut enregistrer et rappeler entre 1 et 3 réglages différents. La caractéristique du réglage préféré peut être utilisée avec Bake ou Timed Bake. Cette caractéristique ne fonctionne pas avec aucune autre caractéristique incluant les réglages de cuisson minutée différée.

### INSTRUCTIONS



#### Programmation du four pour enregistrer le réglage d'une recette et débiter la cuisson (par exemple, une cuisson à 350 °F [175 °C]):

1. Placez la nourriture dans le four.
2. Appuyez sur . "BAKE" clignote et " — — — ° " apparaît à l'écran (Fig. 1)
3. Dans les cinq secondes qui suivent, appuyez sur . ( Note:  ou  peut aussi être utilisé pour enregistrer le réglage d'une recette). "BAKE" clignote, - 1- et " — — — ° " apparaissent à l'écran (Fig. 2).
4. Appuyez sur   . " 350°" apparaît à l'écran (Fig. 3).
5. Appuyez et maintenez la touche  pendant au moins 3 secondes ou jusqu'à ce qu'un signal sonore se fasse entendre. Le signal sonore indique que le réglage de la recette a été enregistré pour pouvoir être rappelé plus tard. Les messages 350° et "BAKE" apparaissent à l'écran (Fig. 4).

**NOTE:** Le four continue la cuisson jusqu'à ce que vous appuyiez

sur .

#### Rappeler le réglage et commencer la cuisson (l'exemple ci-dessous rappelle le réglage à l'aide de la touche 1) :

1. Placez la nourriture dans le four.
2. Appuyez sur . "BAKE" clignote et " — — — ° " apparaît à l'écran (Fig. 5).
3. Dans les cinq secondes qui suivent, appuyez sur . " 350°" apparaît à l'écran (Fig. 3).
4. Appuyez sur . Le four débutera immédiatement la cuisson en utilisant le réglage de la recette enregistré antérieurement (Fig. 4). La température est rappelée et si vous aviez enregistré une cuisson minutée, le temps de cuisson sera également rappelé.

Note: Si vous désirez conserver une recette enregistrée mais enlever le temps de cuisson, appuyez sur  et sur la

touche  ou  ou  (la touche où la recette est enregistrée). Appuyez ensuite sur , entrez le temps  et

finalement appuyez et maintenez la touche  pendant 3 secondes.

### APPUYEZ

### ÉCRAN





Fig. 1

 ou



Fig. 2

 ou 



Fig. 3

maintenez  pendant 3 secondes



Fig. 4





Fig. 5









# Réglage du programmateur électronique (suite)

## Cuisson au grill

La touche  contrôle la fonction de cuisson au grill. Lors de cette méthode, la chaleur radiante provient directement de l'élément supérieur. La fonction cuisson au grill est préréglée à 550°F; toutefois, elle peut être ajustée à des températures allant de 400°F à 550°F. La lèchefrite et son couvercle permettent à la graisse de bien s'égoutter et de rester éloignée de la chaleur provenant de l'élément supérieur. **N'UTILISEZ PAS** la lèchefrite sans son couvercle (Fig. 5). **NE COUVREZ PAS le couvercle de la lèchefrite avec du papier d'aluminium.** La graisse qui s'y accumule pourrait s'enflammer.



**AVERTISSEMENT** Si un feu se produit à l'intérieur du four, fermez la porte et annulez les commandes. Si le feu ne s'éteint pas, couvrez-le de bicarbonate de soude ou utilisez un extincteur d'incendie. **N'UTILISEZ PAS D'EAU OU DE FARINE.** L'eau peut étendre le feu causé par la graisse et la farine risque d'exploser et d'occasionner des blessures.

### INSTRUCTIONS

### APPUYEZ

### ÉCRAN

### Pour régler le four en mode de cuisson au grill à la température préréglée (550°F):

- Placez le couvercle sur la lèchefrite et déposez-y la viande. **N'UTILISEZ PAS** la lèchefrite sans son couvercle. **NE COUVREZ PAS** le couvercle de la lèchefrite avec du papier d'aluminium. La graisse qui s'y accumule pourrait s'enflammer.
- Placez la grille du four à la position voulue et glissez-y la lèchefrite. Assurez-vous de bien placer la lèchefrite au centre, sous l'élément supérieur. **Four électrique seulement: Ouvrez la porte à la position grillage lorsque vous utilisez le four en mode cuisson au grill (Fig. 4). Four au gaz seulement: Fermez la porte du four.** Pour un grillage optimum, préchauffez le brûleur de grillage de 3-4 minutes avant de placer la nourriture dans le four.
- Appuyez sur la touche . "**BROIL**" clignote et "**550°**" apparaît à l'écran (Fig. 1).
- Si une température plus basse est désirée (la température minimale de la cuisson au grill est de 400°F), appuyez sur les touches numériques désirées avant de continuer à l'étape 5.
- Appuyez sur la touche . Le four commence à griller. "**BROIL**" et "**550°**" demeurent à l'écran (Fig. 2).
- Faites griller la viande sur un côté jusqu'à ce qu'elle brunisse; retournez-la et laissez-la griller de l'autre côté. Assaisonner et servir. **Note:** Tirez toujours la grille du four jusqu'à sa position d'arrêt avant de tourner ou d'enlever la viande.
- Appuyez sur la touche  pour annuler la fonction ou lorsque la cuisson est terminée (Fig. 3).

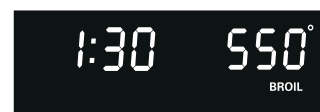

Fig. 1



Fig. 2



Fig. 3

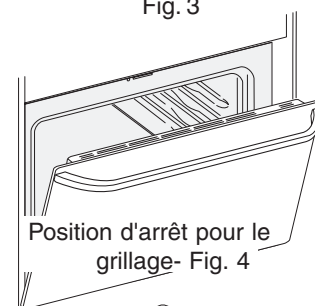

Position d'arrêt pour le grillage- Fig. 4

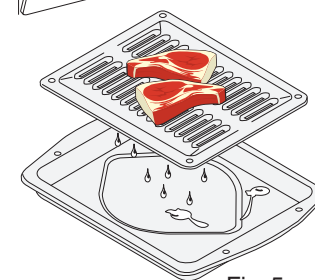

Fig. 5

### Temps de Grillage

Utilisez le tableau suivant pour connaître le temps de grillage. Augmentez ou diminuez le temps de grillage, ainsi que la position de la grille du four pour obtenir le résultat désiré. Si la nourriture que vous grillez n'est pas dans la liste, suivez les instructions de votre recette et surveillez la cuisson.

### Tableau pour la cuisson au grill

Aliment	Position de la grille en partant par le bas	Réglage de la température	Temps de cuisson (min.)		Cuisson
			1er côté	2ième côté	
Bifteck 1" d'épais	3 ou 4	550° F	6:00	4:00	Saignant
	3 ou 4	550° F	7:00	5:00	À point
Côtelette porc 3/4"	3	550° F	8:00	6:00	Bien cuit
Poulet - avec os	2	450° F	20:00	10:00	Bien cuit
Poulet - sans os	3	450° F	8:00	6:00	Bien cuit
Poisson	3	500° F	13:00	n/a	Bien cuit
Crevettes	2	550° F	5:00	n/a	Bien cuit
Hamburger de 1" épais	4	550° F	9:00	7:00	À point
	3	550° F	10:00	8:00	Bien cuit

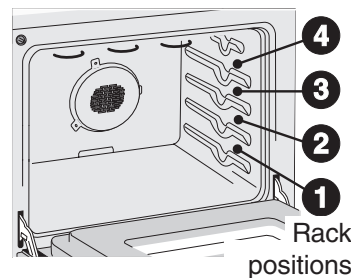



Fig. 6

# Réglage du programmateur électronique (suite)

## La fonction Garder Chaud

La touche  contrôle la fonction Garder Chaud et maintient la température du four à 170°F (77°C). La fonction Garder Chaud conservera les aliments déjà cuits ou chauds à une température idéale pour les servir pendant un maximum de 3 heures après la cuisson. Après 3 heures de fonctionnement, la fonction Garder Chaud s'éteint d'elle-même. La fonction Garder Chaud peut être utilisée seule ou après les fonctions de CUISSON, CUISSON PAR CONVECTION ou RÔTISSAGE PAR CONVECTION.

Si vous désirez que votre four entre en mode Garder Chaud automatiquement après la cuisson, la fonction Garder Chaud peut être aussi utilisée avec les modes de CUISSON MINUTÉE et de DÉPART DIFFÉRÉ. Le programmateur entre alors en mode Garder Chaud lorsque la cuisson minutée ou le départ différé est terminé.

### INSTRUCTIONS

### APPUYEZ

### ÉCRAN



#### Pour régler la fonction Garder Chaud

1. Placez les grilles du four aux positions voulues et les plats à cuisiner dans le four.

2. Appuyez sur la touche . "HLd" apparaît à l'écran (Fig. 1).

Note: Si vous n'appuyez sur aucune touche dans les 25 secondes, la fonction Garder Chaud s'annule.

3. Appuyez sur la touche . L'icône du four apparaît à l'écran (Fig. 2).

4. Pour annuler la fonction Garder Chaud, appuyez sur la touche  OU 

ou  en tout temps. **Note:** La fonction Garder Chaud s'éteint automatiquement après 3 heures de fonctionnement.



Fig. 1



Fig. 2

#### Pour régler la fonction Garder Chaud pour qu'elle démarre automatiquement

1. Placez les grilles du four aux positions voulues et les plats à cuisiner dans le four. Programmez votre four pour une **cuisson minutée** ou un **départ différé**.

2. Appuyez sur la touche  (Fig. 3).

**Note:** Si vous n'appuyez sur aucune touche dans les 25 secondes, la fonction de Garder Chaud s'annule.

3. Appuyez sur la touche . "HLd" disparaît et la température

s'affiche (Fig. 4). La fonction Garder Chaud est programmée pour démarrer automatiquement après la fin de la cuisson minutée ou du départ différé (Fig. 1).

4. Pour annuler la fonction Garder Chaud, appuyez sur la touche 

en tout temps. **Note:** La fonction Garder Chaud s'éteint automatiquement après 3 heures de fonctionnement.



Fig. 3



Fig. 4

Appuyer sur la touche  à tout moment annule toutes les opérations de cuisson préalablement programmées.

Note: La fonction Garder Chaud peut être allumée ou éteinte en tout temps sans annuler la cuisson ou toute autre fonction en appuyant sur .



#### Allumer et éteindre les lampes du four

Les lampes du four s'allument automatiquement à l'ouverture de la porte. Vous pouvez également les allumer ou les éteindre manuellement en appuyant sur la touche .

# Réglage du programmateur électronique (suite)

## Fonction Sabbat (à utiliser le jour du sabbat juif & pendant les autres fêtes)

Les touches **TEMPS DE CUISSON**  et **HEURE DE DÉPART**  contrôlent la fonction Sabbat. La fonction Sabbat peut

être utilisée seulement avec la touche . Il est possible d'augmenter ou de diminuer la température du four après avoir activé la fonction Sabbat (l'ajustement de la température du four peut être fait seulement lors des fêtes juives), toutefois l'écran n'affiche plus les ajustements et active le mode silencieux lors de l'ajustement de la température. Lorsque le four est réglé pour une cuisson avec la fonction Sabbat en opération, le four va fonctionner continuellement jusqu'à ce qu'il soit annulé. La fonction Sabbat passera outre le mode Arrêt automatique après 12-heures préprogrammé à l'usine. Si la lumière du four doit être allumée durant le jour du sabbat, appuyez sur la touche  avant d'activer la fonction Sabbat. Si la lumière du four est allumée et que la fonction Sabbat est active, cette dernière restera allumée jusqu'à ce que la fonction Sabbat soit annulée. Si la lumière du four doit rester éteinte, assurez-vous de l'éteindre avant d'activer la fonction Sabbat.

**NOTES IMPORTANTES:** Il n'est pas conseillé d'essayer d'activer d'autres fonctions que **CUISSON** lorsque la fonction Sabbat est active. Les SEULES touches pouvant être activées lorsque la fonction Sabbat est active sont les suivantes: les touches

numériques de 0 à 9,  & . **TOUTES LES AUTRES TOUCHES** resteront inactives si la fonction Sabbat est adéquatement activée.

### INSTRUCTIONS

### APPUYEZ

### ÉCRAN

#### Pour régler le four pour qu'il commence la cuisson immédiatement & activer la fonction Sabbat (exemple: pour cuire à 350°F)







1. Assurez-vous que l'horloge est à l'heure juste.
2. Placez les plats à cuisiner dans le four.
3. Appuyez sur , "— — — °" apparaît à l'écran (Fig. 1).
3. appuyez sur    (Fig. 2). "BAKE" clignote et "350°F (177°C)" apparaît à l'écran.
4. Appuyez sur . L'écran affiche "350°F" et "BAKE". Le four s'allume et commence à chauffer (Fig. 3).
5. Si vous désirez régler le programmateur pour une **Cuisson Minutée** ou un **Départ Différé** faites le maintenant. Sinon, continuez à l'étape 6. Référez-vous à la section **Cuisson Minutée/ Départ Différé** pour les instructions complètes. Rappelez-vous que le four s'éteindra lorsque la **Cuisson Minutée** ou le **Départ Différé** sera terminé. Le four ne pourra donc pas être utilisé à nouveau durant le jour du Sabbat /Fêtes juives. Le départ différé le plus éloigné pouvant être programmé est à 11 heures & 59 minutes.
6. Appuyez et maintenez simultanément les touches  et  pendant au moins 3 seconds. Un signal sonore se fera entendre. **SAb** apparaît à l'écran (Fig. 4). Une fois que **SAb** apparaît à l'écran, le programmateur arrête d'émettre des signaux sonores lorsque les touches sont appuyées et d'afficher les changements futurs. Le four est alors correctement réglé en mode Sabbat.



Fig. 1



Fig. 2





Fig. 3





Fig. 4

## Réglage du programmateur électronique (suite)

### Fonction Sabbat (à utiliser le jour du sabbat juif & pendant les autres fêtes)

**Note:** Vous pouvez modifier la température lorsque le four est en marche en appuyant sur , enter la température que vous désirez (170 to 550F°) et appuyer sur  deux fois (durant les Fêtes juives seulement). Rappelez-vous que le programmateur n'émet pas de signaux sonores lorsqu'une touche est appuyée et que l'écran n'affiche plus les changements une fois que la fonction Sabbat est active.

7. Le four peut être ÉTEINT en tout temps en appuyant sur  (ceci éteint le four seulement). Pour désactiver la fonction Sabbat appuyez et maintenez simultanément les touches  et  pendant au moins 3 secondes. **SAb** disparaît de l'écran (Fig. 1).

Il est recommandé d'appuyer deux fois sur la touche START après avoir changé la température du four pendant que la caractéristique du sabbat est activée. Vous vous assurez ainsi que le four demeure allumé même si vous avez tenté de régler la température au-dessous ou au-delà de ce que peut accepter le régulateur de four. Si la température de four est réglée incorrectement, celle-ci se règle par défaut à 170 °F ou 550 °F (75 °C ou 285 °C). Essayez à nouveau de régler la température du four.



Lors d'une panne ou d'une interruption de courant survient, le four s'éteint. Lorsque le courant revient le four ne se rallume pas automatiquement. Le programmateur est toujours en fonction Sabbat la nourriture peut alors être retiré du four de façon sécuritaire même si la fonction Sabbat est encore active. Toutefois le four ne peut pas être rallumé avant la fin du jour du Sabbat. Une fois le jour du Sabbat terminé, désactivez la fonction Sabbat en appuyant et maintenant enfoncé simultanément les



touches  et  pendant au moins 3 secondes. **SAb** disparaît de l'écran et le four peut alors être utilisé de façon habituelle.

Pour plus d'assistance, d'aide pour un usage adéquat de la fonction Sabbat ainsi que pour consulter la liste complète des modèles possédant la fonction Sabbat, s'il vous plaît visitez le site internet <http://www.star-k.org>.

# Cycle autonettoyant

## Durée d'un cycle autonettoyant

Les touches ,  et  contrôlent le cycle autonettoyant. Si vous planifiez utiliser le four juste après un cycle autonettoyant, n'oubliez pas d'allouer du temps pour le refroidissement du four ainsi que le déverrouillage de la porte. Habituellement cela prend une heure. Donc pour un cycle de nettoyage de 3 heures, allouez en réalité 4 heures.

\* Afin d'assurer un nettoyage du four satisfaisant, il est recommandé de faire un cycle  (2 heures) pour les fours présentant des **taches légères**, un cycle  (3 heures) pour un four **moyennement sale** et un cycle  (4 heures) pour les fours ayant des **taches tenaces**.

**NOTE:** Un éliminateur de fumée installé dans le conduit d'aération, transforme la plupart des saletés en une vapeur invisible.

**⚠ AVERTISSEMENT** Lors du cycle autonettoyant l'extérieur de l'appareil peut devenir très chaud au toucher. NE laissez PAS d'enfant en bas âge sans surveillance près de l'appareil.

**⚠ ATTENTION** Afin d'éviter tout risque de brûlure lors de l'ouverture de la porte après un cycle autonettoyant, tenez vous sur le côté de l'appareil. Laissez d'abord l'air chaud ou la vapeur s'échapper du four avant de vous approcher.

**⚠ ATTENTION** NE FORCEZ PAS LA PORTE DU FOUR POUR L'OUVRIER. Ceci risque d'endommager le système de verrouillage. Soyez prudent lorsque vous l'ouvrez à la fin d'un cycle autonettoyant; tenez-vous sur le côté du four pour donner libre cours à la chaleur et à la vapeur qui s'en échappent. Le four peut être encore **TRÈS CHAUD**.

### INSTRUCTIONS

### APPUYEZ

### ÉCRAN

**Débuter un cycle autonettoyant immédiatement ou régler une mise en marche différée à 4h30 et l'arrêt automatique (Dans l'exemple, le cycle autonettoyant par défaut utilisé est celui de 3 heures.):**





1. Assurez-vous que l'horloge est à l'heure juste, qu'il n'y a rien dans le four et que la porte est bien fermée.
2. Appuyez sur la touche . "**CLEAN**" clignote et "**3:00**" HR apparaît (Fig. 1). Le programmeur électronique est automatiquement réglé pour une période de 3 heures. Note: Si un cycle de 2 ou de 4 heures est souhaité, appuyez sur la touche  pour un cycle de 2 heures ou sur  pour un cycle de 4 heures. Sélectionnez le temps du cycle de nettoyage dépendamment de la saleté dans le four—taches légères, moyennement taché ou taches tenaces (\*voir plus haut).
3. Appuyez sur la touche . "**DOOR LOCKED**" clignote; "**CLEAN**" et "**CLn**" restent affichés à l'écran (Fig. 2).
4. Aussitôt que le programmeur est réglé, le moteur verrou de la porte se met en marche afin de barrer la porte automatiquement. Une fois la porte barrée "**DOOR LOCKED**" cesse de clignoter et demeure allumé à l'écran. L'icône du four apparaît à l'écran. (Fig. 3).



Fig. 1



Fig. 2



Fig. 3

Note: La porte du four prend environ 15 secondes pour se barrer complètement.

# Cycle autonettoyant (suite)

## INSTRUCTIONS

## APPUYEZ

## ÉCRAN

**Note:** Si vous voulez utiliser la caractéristique optionnelle d'autonettoyage différé, suivez les étapes 5 à 7. Si vous désirez que l'autonettoyage débute immédiatement, sautez les étapes restantes et reportez-vous à la section "À la fin du cycle d'autonettoyage" plus loin.

5. Appuyez sur la touche . Entrez l'heure de départ désirée en utilisant les touches numériques    (Fig. 1).



Fig. 1

6. Appuyez sur la touche . "CLn" disparaît; "DELAY", "DOOR LOCKED" et "CLEAN" restent à l'écran (Fig. 2).

7. Le four débutera son cycle autonettoyant à l'heure programmée, pour la période préalablement sélectionnée. À ce moment "DELAY" disparaît; "CLn" et l'icône du four apparaissent à l'écran (Fig. 3).



Fig. 2



Fig. 3

### Lorsque le cycle autonettoyant est complété

1. L'heure, "END", "DOOR LOCKED" et "CLEAN" restent affichés.
2. Lorsque le four est refroidi (après environ 1 heure), et que "DOOR LOCKED" disparaît, la porte du four peut alors être ouverte.

### Pour arrêter ou interrompre le cycle autonettoyant:

Si un cycle autonettoyant doit être arrêté ou interrompu à cause d'une fumée excessive ou d'un incendie dans le four:

1. Appuyez sur la touche .
2. Lorsque le four est refroidi (après environ 1 heure), et que "DOOR LOCKED" disparaît, la porte du four peut alors être ouverte (Fig. 4).



Fig. 4

### REMARQUES IMPORTANTES lors de l'utilisation de la caractéristique d'autonettoyage:

1. La fonction d'autonettoyage ne fonctionne pas si l'un des éléments radiants (certains modèles) de surface est en marche.
2. Certains modèles ne permettent pas l'utilisation de la surface de cuisson lorsque le four fonctionne en cycle autonettoyant. Le symbole  apparaissant à l'écran (Fig. 5) indique que la surface de cuisson est verrouillée. La surface de cuisson demeure verrouillée jusqu'à ce que le cycle autonettoyant soit terminé et que la porte du four est débarrée.
3. Le cycle d'autonettoyage ne peut pas débiter si la caractéristique de verrouillage du four est activée.
4. Si le cycle d'autonettoyage est interrompu par une panne d'électricité, l'appareil peut ne pas être complètement nettoyé. Une fois l'électricité revenue, terminez le nettoyage en reprogrammant le four pour un cycle d'autonettoyage.
5. Si l'horloge est programmée pour un affichage sur 12 heures, le cycle d'autonettoyage différé ne peut jamais débiter plus de 12 heures à l'avance. Pour programmer le cycle d'autonettoyage différé 12 à 24 heures à l'avance, référez-vous à la page 16 pour obtenir des instructions permettant de programmer le four pour un mode d'affichage de l'heure sur 24 heures.



Fig. 5





## Ajustement de la température du four

La température du four a été réglée à l'usine. Assurez-vous, lors du premier usage, de suivre les durées de cuisson et les températures de la recette. Si vous estimez que le four est trop chaud ou trop froid, la température peut alors être ajustée. Avant de procéder à un tel ajustement, faites un essai avec la recette en réglant la température à un degré légèrement supérieur ou inférieur à la température recommandée dans la recette. Les résultats de la cuisson devraient vous aider à décider de l'ajustement nécessaire.







**Note:** Les ajustements de la température ne changeront pas la température de la fonction nettoyage ou de la fonction cuisson au grill.

### INSTRUCTIONS

#### Pour augmenter la température du four

1. Appuyez sur la touche  pendant 6 secondes. 0° apparaît à l'écran (Fig. 1).
2. Pour augmenter la température du four, entrez le réglage indiqué en appuyant sur les touches numériques (Exemple 30°F)   (Fig. 2). La température peut être augmentée d'un maximum de 35°F (19°C).
3. Appuyez sur la touche  pour confirmer le changement et retourner à l'affichage de l'heure (Fig. 3). Appuyez sur la touche  pour annuler le changement.

#### Pour diminuer la température du four

1. Appuyez sur la touche  et maintenez-la pendant 6 secondes. 0° apparaît à l'écran (Fig. 4).
2. Pour diminuer la température du four, entrez le réglage indiqué en appuyant sur les touches numériques (Exemple 30°F)   et appuyez sur la touche  (Fig. 5). La température peut être diminuée d'un maximum de 35°F (19°C).
3. Appuyez sur la touche  pour confirmer le changement et retourner à l'affichage de l'heure (Fig. 6). Appuyez sur la touche  pour annuler le changement.

### APPUYEZ

  OU  OU

### ÉCRAN



Fig. 1



Fig. 2

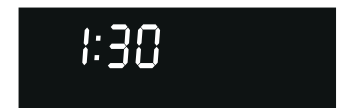

Fig. 3



Fig. 4



Fig. 5

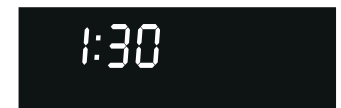

Fig. 6