



website: <http://www.lgservice.com>

e-mail: <http://www.lgservice.com/techsup.html>

LRTB2023W, LRTB2023BS LRTB2023BK

REFRIGERATOR- FREEZER OWNER'S MANUAL

PLEASE
READ THIS OWNER'S MANUAL THOROUGHLY
BEFORE OPERATING AND KEEP IT HANDY
FOR REFERENCE AT ALL TIMES.

RÉFRIGÉRATEUR- CONGÉLATEUR MANUEL DE L'UTILISATEUR

LISEZ ATTENTIVEMENT CE MANUEL AVANT FAIRE
FONCTIONNER L'APPAREIL ET CONSERVEZ-LE
POUR TOUTE RÉFÉRENCE À TOUT MOMENT.

REFRIGERADOR- CONGELADOR MANUAL DE INSTRUCCIONES

LEA ESTE MANUAL DE INSTRUCCIONES
DETENIDAMENTE Y GUÁRDELO COMO
REFERENCIA PARA EL FUTURO.

P/NO. 3828JD8315V

TABLE OF CONTENTS

REFRIGERATOR SAFETY	3
INSTALLING YOUR REFRIGERATOR	4
Unpacking Your Refrigerator	4
Installation	4
Electrical Requirements	5
FEATURES CHART	6
OPERATION	7
Starting	7
Temperature Control	7
Ice Making	8
Defrosting	8
Disassembly and Adjustment	9
SUGGESTIONS ON FOOD STORAGE	10
CLEANING YOUR REFRIGERATOR	11
LAMP REPLACEMENT	12
GENERAL INFORMATION	12
REPLACEMENT OF DOOR OPENING TYPE	13
BEFORE CALLING FOR SERVICE	16

REFRIGERATOR SAFETY

Your safety and the safety of others is very important.

We have provided many important safety messages in this manual and on your appliance. Always read and obey all safety messages.



This is the safety alert symbol.

This symbol alerts you to hazards that can kill or hurt you and others.

All safety messages will be preceded by the safety alert symbol and the word **DANGER** or **WARNING**. These words mean:

DANGER

You will be killed or seriously injured if you don't follow instructions.

WARNING

You can be killed or seriously injured if you don't follow instructions.

All safety messages will identify the hazard, tell you how to reduce the chance of injury, and tell you what can happen if the instructions are not followed.

IMPORTANT SAFETY INSTRUCTIONS

WARNING: To reduce the risk of fire, electric shock, or injury when using your refrigerator, follow these basic precautions:

- Plug into a grounded 3-prong outlet.
- Do not remove ground prong.
- Do not use an adapter.
- Do not use an extension cord.
- Disconnect power before servicing.
- Replace all panels before operating.
- Remove doors from your old refrigerator.
- Use nonflammable cleaner.
- Keep flammable materials and vapors, such as gasoline, away from refrigerator.
- Use two or more people to move refrigerator using handles and install refrigerator.
- Disconnect power before installing ice maker.
(on some models)

SAVE THESE INSTRUCTIONS

Proper Disposal of Your Old Refrigerator

DANGER

Suffocation Hazard

Remove doors from your old refrigerator. Failure to do so can result in death or brain damage.

IMPORTANT - Child entrapment and suffocation are not problems of the past. Junked or abandoned refrigerators are still dangerous - even if they will sit for just a few days. If you are getting rid of your old refrigerator, please follow these instructions to help prevent accidents.

Before you throw away your old refrigerator or freezer:

- Take off the doors.
- Leave the shelves in place so that children may not easily climb inside.

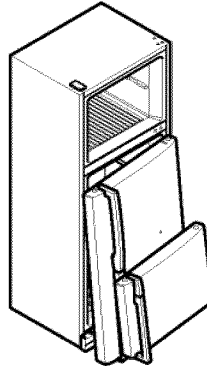

ENGLISH

INSTALLING YOUR REFRIGERATOR

⚠ WARNING

Excessive Weight Hazard

Use two or more people to move and install refrigerator.

Failure to do so can result in back or other injury.

Unpacking Your Refrigerator

Remove tape and any temporary labels from your refrigerator before using. Do not remove any warning type labels, the model and serial number label, or the Tech Sheet that is attached to back wall of the refrigerator.

To remove any remaining tape or glue, rub the area briskly with your thumb. Tape or glue residue can also be easily removed by rubbing a small amount of liquid dish soap over the adhesive with your fingers. Wipe with warm water and dry.

Do not use sharp instruments, rubbing alcohol, flammable fluids, or abrasive cleaners to remove tape or glue. These products can damage the surface of your refrigerator. For more information, see **Important Safety Instructions** in the **Refrigerator Safety** section.

Refrigerator shelves are installed in the shipping position.

Please reinstall shelves according to your individual storage needs.

When Moving Your Refrigerator:

Your refrigerator is heavy. When moving the refrigerator for cleaning or service, be sure to protect the floor.
Always pull the refrigerator straight out when moving it.
Do not wiggle or walk the refrigerator when trying to move it, as floor damage could occur.



⚠ WARNING



Explosion Hazard

Keep flammable materials and vapors, such as gasoline, away from refrigerator. Failure to do so can result in death, explosion, or fire.

Installation

1. Avoid placing the unit near heat sources, direct sunlight, or moisture.
2. To avoid vibration, the unit must be level. If required, adjust the leveling screws to compensate for unevenness of the floor. The front should be slightly higher than the rear to aid in door closing. Leveling screws can be turned easily by tipping the cabinet slightly. Turn the leveling screws clockwise () to raise the unit, counterclockwise () to lower it.
3. Install this appliance between 55 °F (13 °C) and 110 °F (43 °C.) If the temperature around the appliance is too low or high, cooling ability may lessen.

NEXT

1. Clean your refrigerator thoroughly and wipe off all dust accumulated during shipping.
2. Install accessories such as ice cube bin, drawers, shelves, etc., in their proper places. They are packed together to prevent possible damage during shipment.
3. Let your refrigerator run for 2 or 3 hours before putting food in it. Check the flow of cold air in the freezer compartment to ensure proper cooling. Your refrigerator is now ready for use.

Electrical Requirements

⚠ WARNING

Electrical Shock Hazard Plug into a grounded 3-prong outlet. Do not remove ground prong. Do not use an adapter. Do not use an extension cord. Failure to follow these instructions can result in death, fire, or electrical shock.

Before you move your refrigerator into its final location, it is important to make sure you have the proper electrical connection:

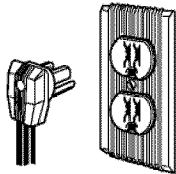

Recommended Grounding Method

A 115 Volt, 60 Hz., AC only 15 or 20 ampere fused, grounded electrical supply is required. It is recommended that a separate circuit serving only your refrigerator be provided. Use an outlet that cannot be turned off by a switch. Do not use an extension cord.

NOTE: Before performing any type of installation, cleaning, or removing a light bulb, turn the control, (Thermostat, Refrigerator, or Freezer Control depending on the model) to OFF and then disconnect the refrigerator from the electrical source. When you are finished, reconnect the refrigerator to the electrical source and reset the control (Thermostat, Refrigerator, or Freezer Control, depending on the model) to the desired setting.

ENGLISH

FEATURES CHART

FREEZER COMPARTMENT

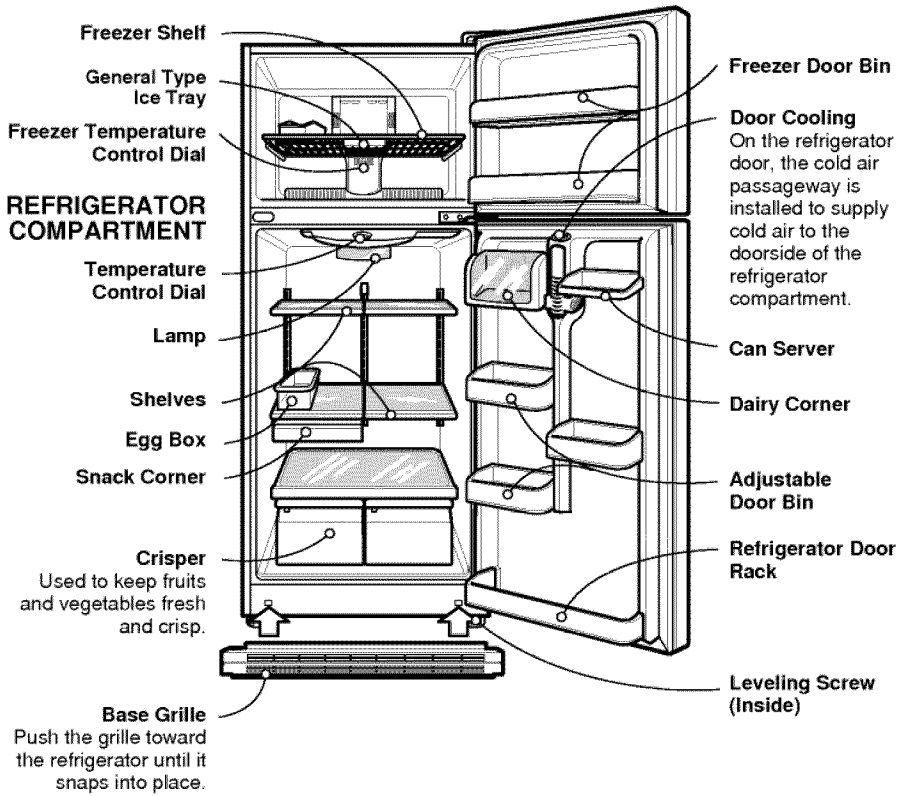

OPERATION

Starting

When your refrigerator is first installed, allow to run 2-3 hours to stabilize at normal operating temperature prior to filling it with fresh or frozen foods.

If operation is interrupted, wait 5 minutes before restarting.

Temperature Control

REFRIGERATOR



REFRIGERATOR CONTROL

- Your refrigerator has two controls that let you regulate the temperature in the freezer and refrigerator compartments.
- Initially set the REFRIGERATOR CONTROL at 5 and the FREEZER CONTROL at 2. Leave it at this setting for 24 hours (one day) to stabilize. Then adjust the compartment temperature according to your desire.
- **REFRIGERATOR CONTROL** - 1, 2, 3, 4, 5, 6, 7, 8
The higher the number setting, the colder the refrigerator compartment will become.
- To turn the refrigerator off, turn the dial to the right to the word "off".

FREEZER

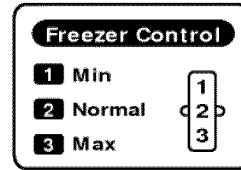

- **FREEZER CONTROL** - 1, 2, 3
Setting at 3, the freezer compartment becomes colder. But the refrigerator compartment becomes warmer because less cold air flows into the refrigerator compartment.
- In cold weather the unit operates less and the freezer compartment has a tendency to warm up. For a colder freezer, turn the FREEZER CONTROL to 3.
- If you put a lot of food in the freezer or open its door frequently, its temperature is apt to be somewhat higher. In this case, set the FREEZER CONTROL dial at 3 to cool it. Return the FREEZER CONTROL dial to the original position to cut down the consumption of energy.
- **In hot weather or if a lot of food is put in the refrigerator compartment**, the refrigerator compartment has a tendency to warm up. For a colder refrigerator, turn the FREEZER CONTROL to 1 to direct more cold air into the refrigerator compartment, and the REFRIGERATOR CONTROL to 6~8. If the FREEZER CONTROL is set at 3, the refrigerator compartment will not be cold enough.

ENGLISH

ICE MAKING (For General Type Ice Maker)

- If the tray is filled with water to the highest level, it will be difficult to remove ice cubes.
- For quick freeze, adjust the freezer dial to 3.

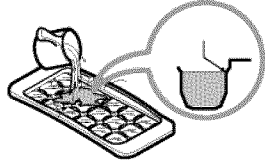

To remove ice cubes, twist the tray.

- Do not warp the ice tray. Doing so may result in damage to the tray.
- To remove ice cubes easily, pour water on the tray or soak it into water before removing ice cubes.

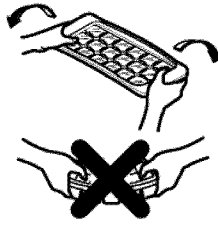

Defrosting

- Defrosting takes place automatically.
- Defrosted water flows down to the evaporating tray which is located in the lower back side of the refrigerator and is evaporated automatically.

Adjusting the Crisper Humidity Control

You can control the amount of humidity in the moisture-sealed crispers. Adjust the control to any setting between Veg. and Fruit.

- Fruit (open) lets moist air out of the crisper for best storage of fruits.
- Veg. (closed) keeps moist air in the crisper for best storage of fresh, leafy vegetables.

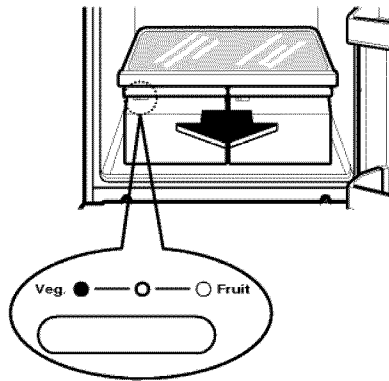

Freezer Shelf

Lift the front side of the shelf slightly and pull it forward to remove it.

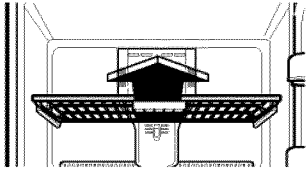

CAUTION

Make sure that a shelf is placed horizontally.

Failure to do so may result in falling of the shelf, causing spilling or spoiling of food.

■ Encouraged shelf position

If you put shelf on the place indicated by arrow, it is profitable for the food storage.

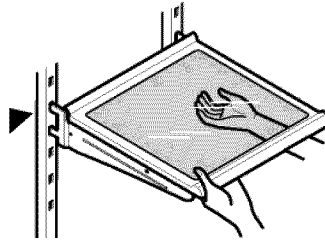

Adjusting Shelves

The shelves in your refrigerator are adjustable to make room for various types of food.

■ To remove a shelf

Tilt up the front of the shelf in the direction of (1) and lift it in the direction of (2). Pull the shelf out.

■ To replace a shelf

Tilt the front of the shelf up and guide the shelf hooks into the slots at a desired height. Then lower the front of the shelf so that the hooks drop into the slots.

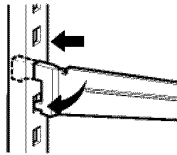
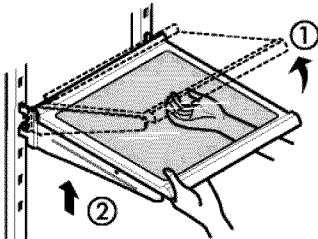

Snack Corner

While holding it with one hand, pull it forward slightly.

Lift it slightly and pull it out.

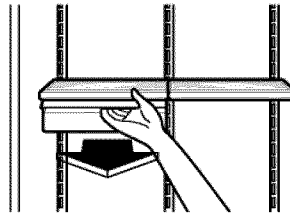

ENGLISH

SUGGESTIONS ON FOOD STORAGE

Storing Food

- Store fresh food in the refrigerator compartment. How food is frozen and defrosted is an important factor in maintaining freshness and flavor.
- Do not store food which spoils easily at low temperatures, such as bananas, pineapples, and melons.
- Allow hot food to cool prior to storing. Placing hot food in the refrigerator could spoil other food, and lead to high electricity bills!
- When storing, wrap food in vinyl, or place in a covered container. This prevents moisture from evaporating, and helps food to keep its taste and nutritional value.
- Do not block air vents with food. Smooth circulation of chilled air keeps the refrigerator temperature even.
- Do not open the door frequently. Opening the door lets warm air enter the refrigerator, causing temperature to rise.
- To adjust the temperature control easily, do not store food near the temperature control dial.

Freezer Compartment

- Do not store bottles in the freezer compartment - they may break when frozen.
- Do not refreeze food that has been defrosted. This causes loss of taste and nutritional value.
- When storing frozen food, like ice cream, for a long period, place it on the freezer shelf, not in the door rack.

Refrigerator Compartment

- Avoid placing moist food on deep interior refrigerator shelves, it could freeze upon direct contact with chilled air. To avoid this, it is better to store food in a covered container.
- Always clean food prior to refrigeration. Vegetables and fruits should be washed and wiped, and packed food should be wiped clean, to prevent other food from spoiling.

NOTE

- If you keep the refrigerator in a hot and humid place, frequently opening the door or putting a lot of vegetables in it may cause dew to form. This has no effect on its performance. Remove the dew with a dry, dust-free cloth.
- If droplets form beneath the cover of the vegetable drawer, keep vegetables or fruits wrapped with plastic wrap.

CLEANING YOUR REFRIGERATOR

⚠ WARNING



Explosion Hazard

Use nonflammable cleaner.

Failure to do so can result in death, explosion, or fire.

Both the refrigerator and freezer sections defrost automatically. However, clean both sections about once a month to prevent odors from building up. Wipe up spills immediately.

To clean your refrigerator.

- Unplug refrigerator or disconnect power.
- Remove all removable parts from inside, such as shelves, crispers, etc.
- Use a clean sponge or soft cloth and a mild detergent in warm water. Do not use abrasive or harsh cleaners.
- Hand wash, rinse, and dry all surfaces thoroughly.
- Plug in refrigerator or reconnect power.

■ Additional cleaning tips are listed below:

PART	COMMENTS
Outside	<ul style="list-style-type: none"> ■ Waxing external painted metal surfaces helps provide rust protection. Do not wax plastic parts. Wax painted metal surfaces at least twice a year using appliance wax (or auto paste wax). Apply wax with a clean, soft cloth. ■ For products with a stainless steel exterior, use a clean sponge or soft cloth and a mild detergent in warm water. Do not use abrasive or harsh cleaners. Dry thoroughly with a soft cloth.
Inside walls (allow freezer to warm up so cloth won't stick)	<ul style="list-style-type: none"> ■ To help remove odors, you can wash the inside of the refrigerator with a mixture of baking soda and warm water. Mix 2 tablespoons soda to 1 quart of water (26 g soda to 1 liter water.) Be sure the soda is completely dissolved so it is not abrasive and doesn't scratch the surfaces of the refrigerator.
Door liners and gaskets	<ul style="list-style-type: none"> ■ Do not use cleaning waxes, concentrated detergents, bleaches, or cleaners containing petroleum on plastic parts.
Plastic parts (covers and panels)	<ul style="list-style-type: none"> ■ Do not use paper towels, window sprays, abrasive cleansers, or flammable fluids. These can scratch or damage material.
Condenser coils	<ul style="list-style-type: none"> ■ Remove base grille. (See the Base grille section on page 6.) ■ Use a vacuum with an extended attachment to clean condenser coils. ■ Vacuum coils when dusty or dirty. Coils may need to be cleaned as often as every other month. ■ Replace base grille.

ENGLISH

LAMP REPLACEMENT

1. Unplug the power cord from the outlet.
2. Remove refrigerator shelves.
3. Upper Refrigerator Lamp.
Release the hooks on both ends of the lamp shield and pull the shield downward to remove it.
4. Turn the lamp counterclockwise.
5. Assemble in reverse order of disassembly.
Replacement bulb must be the same specification as original. (Max 40 W)

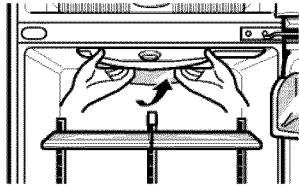

GENERAL INFORMATION

Vacation Time

During average length vacations, you will probably find it best to leave the refrigerator in operation. Place freezable items in freezer for longer storage. When you plan to be away for an extended period,

- Disconnect the power cord or set refrigerator Dial knob to off position.
- Remove all food and other items from the unit.
- Clean the unit thoroughly.
- Leave the shelves in the unit to discourage children from playing in the unit.
- Leave the doors open and block them to ensure that they cannot be closed.

Power Failure

Most power failures are corrected in an hour or two and will not affect your refrigerator temperatures. However, you should minimize the number of door openings while the power is off. During power failures of longer duration, place a block of dry ice on top of your frozen packages.

If You Move

Remove or securely fasten down all loose items inside the refrigerator.
To avoid damaging the leveling screws, turn them all the way into the base.

Anti-Condensation Pipe

The outside wall of the refrigerator cabinet may sometimes get warm, especially just after installation. Don't be alarmed. This is due to the anti-condensation pipe, which pumps hot refrigerant to prevent sweating on the outer cabinet wall.

Anti-Condensation Pipe

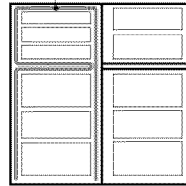

CAUTION

- Dry ice is very cold! Do not allow it to touch bare skin. It is well below 0 °F and will cause immediate frostbite and damage to the skin and other tissue.
- Dry ice is frozen carbon dioxide. Use only in a well ventilated area. As the ice releases carbon dioxide vapor, it could cause light-headedness, fainting, suffocation, or death.

REPLACEMENT OF DOOR OPENING TYPE

⚠ PRECAUTION

1. Before replacing the door opening type, first of all, you should take out of food and accessories like shelves or trays, which are not fixed in the refrigerator.
2. Use a '+' Driver, Bolt Driver, Torque Wrench or Spanner to fix or remove the bolt.
3. Be careful not to tip over the refrigerator in disassembling or assembling the Lower Hinge and the Adjustable Screw Asm. Don't lay the refrigerator down when working it will cause it to malfunction.
4. Be careful not to drop the door in disassembling or assembling the freezer or the refrigerator door.
5. This refrigerator, according to the installation position or user's preference can have the door opening from the right or left.

How to Replace the Door Opening Left to Right (when converting from the left-opening type to right opening type)

1. Removing Freezer Door

- Separate the top hinge cover (1).
- Loosen 3 screws and separate off the top hinge (2).
- Lift the freezer door (3) slightly and separate it.
- Separate the cover (4) using a (-)-screwdriver and fix it on the right.
- Loosen the screw (5), separate off the stopper (6), and fix it on the left (on the opposite side).
- Separate the cover (7) using a (-)-screwdriver and fix it on the right.
- Separate off (8).

2. Removing Refrigerator Door

- Loosen the screw (9) and separate off the middle hinge (10).
- Lift the door (11) slightly and separate it.
- Take off the Grille (12).
- Loosen the screw (14) and fix the pin (15) and the cap (16) into the hole on the left.
- Remove the screw (17).
- Loosen the screw (18). Separate the bottom hinge (20) and fix it on the left.
- Fix the screw (17) on the right.
- Loosen the screw (22) and fix the stopper (23) on the left.

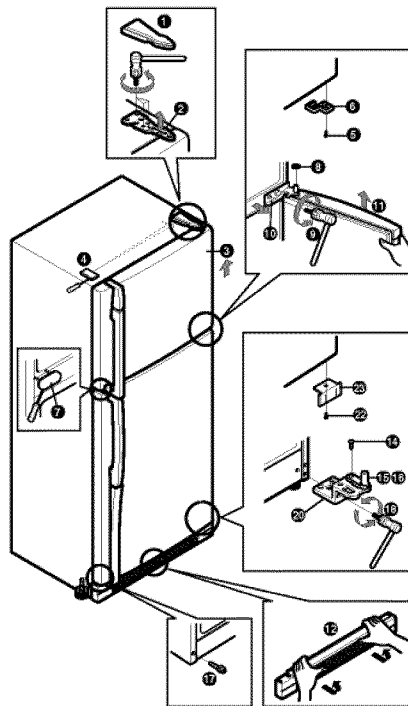

ENGLISH

3. Moving Freezer Handle

- Loosen 2 screws (4).
- Loosen the screws (1) (two on the top and two on the bottom), take off the handle (2), and attach it on the right.
- Attach the removed 2 screws (4) on the left.
- Attach the cap (3) on the top on the opposite side.

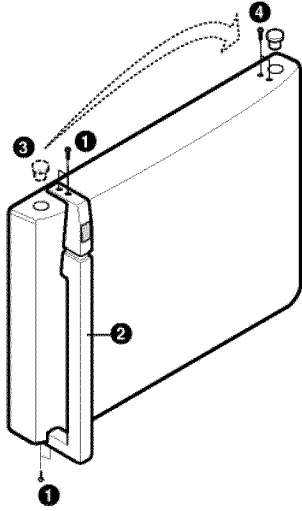

4. Moving Refrigerator Handle

- Separate the cap (8) and loosen 2 screws (9).
- Loosen 1 screw (6) (on the bottom), pull the cover (5) downward, and take it off.
- Loosen 3 screws (6) (two on the top and one on the center), take off the handle (7) and attach it on the right.
- Attach the cover (5) by pushing it up.
- Attach the removed cap (8) and 2 screws (9) on the left.
- Take off the cap (10) and attach it on the right.

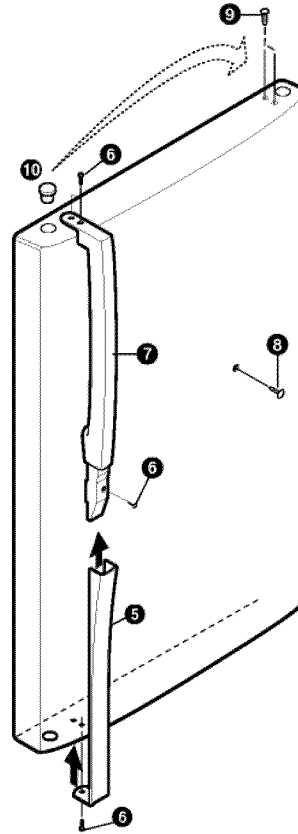

5. Attaching Refrigerator Door

- Fix the base Grille (1).
- Fix the door (3) to the bottom hinge pin.
- Fix the middle hinge (4) on the opposite side with the screw (5).

6. Attaching Freezer Door

- Place the washer (6) to the middle hinge pin (7).
- Place the door (8) so that it fit (5) into the middle hinge pin (7).
- Fix the top hinge(10) with screws.
- Fix top hinge cover (11).

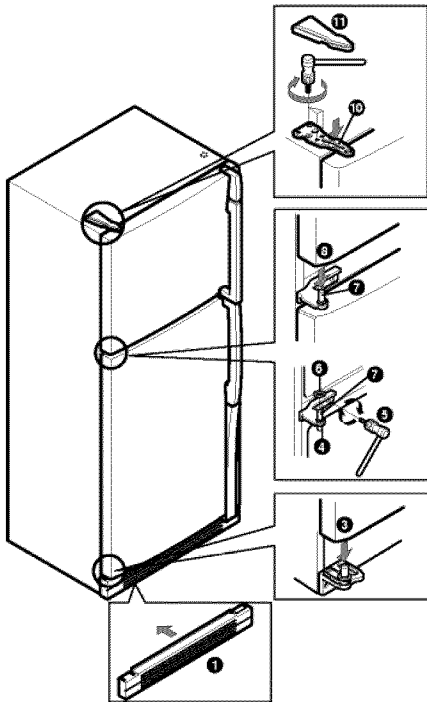

7. After Completing the job

- Make sure that the four corners of the door gasket are not folded. It is recommended to apply a small amount of silicon grease on them.
- Adjust the leveling screw on the bottom to the highest level so that the front side of the refrigerator is higher than the rear side.
- If you need assistance after switching the direction of the door opening as shown above, call a service center.

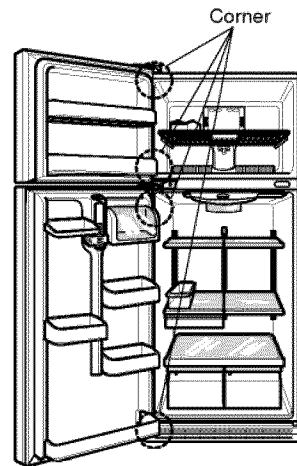

ENGLISH

BEFORE CALLING FOR SERVICE

SERVICE CALLS CAN OFTEN BE AVOIDED!
IF YOU FEEL YOUR REFRIGERATOR IS NOT OPERATING PROPERLY, CHECK THESE POSSIBLE CAUSES FIRST:

PROBLEM	POSSIBLE CAUSES
REFRIGERATOR DOES NOT OPERATE	<ul style="list-style-type: none"> ■ Has a house fuse blown or circuit breaker tripped? ■ Has the power cord plug been removed or loosened from the electrical wall outlet?
REFRIGERATOR OR FREEZER COMPARTMENT TEMPERATURE TOO WARM	<ul style="list-style-type: none"> ■ Temperature control not set on proper position. ■ Appliance is placed close to wall or heat source. ■ Warm weather-frequent door openings. ■ Door is not closed entirely. ■ Door left open for a long time. ■ Large amount of foods are kept in the refrigerator.
ABNORMAL NOISE(S)	<ul style="list-style-type: none"> ■ Refrigerator is installed in a weak or uneven place or leveling screw needs adjusting. ■ Unnecessary objects placed in the back side of the refrigerator.
REFRIGERATOR HAS ODOR	<ul style="list-style-type: none"> ■ Foods with strong odors should be tightly covered or wrapped. ■ Interior needs cleaning.
DEW FORMS ON THE CABINET SURFACE	<ul style="list-style-type: none"> ■ Not unusual during periods of high humidity. ■ Door may have been left ajar.

Customer Assistance Numbers:

- To Prove Warranty Coverage
Retain your Sales Receipt to prove date of purchase.
A copy of your Sales Receipt must be submitted at the time warranty service is provided.
- To Obtain Product, Customer or Service Assistance
Call Toll-free for Customer Service
Tel : 1-877-714-7486
- To Obtain Nearest Authorized Service Center
Call 1-877-714-7486, push option #1, 24 hours a day, 7days per week.
Please have your product type (Monitor, TV, VCR, MWO, Refrigerator) and ZIP code ready.

NOTE

ENGLISH

