

use & care guide

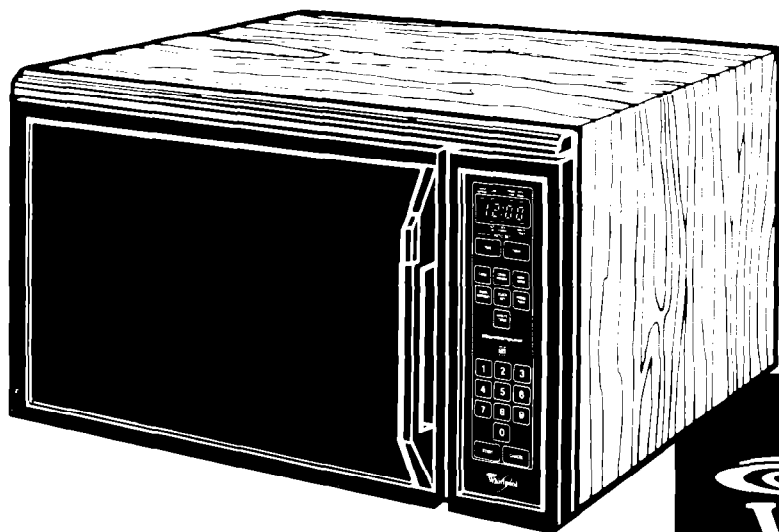

**MICROWAVE
OVEN**

The Whirlpool logo, consisting of the word "Whirlpool" in a stylized, serif font. Above the letter 'i' in "Whirlpool" is a graphic element resembling a swirl or a stylized wave, which is part of the brand's identity. The logo is set against a solid black rectangular background.

Model MW8650XS

Freezers, Ice Makers, Dishwashers, Built-In Ovens and Surface Units, Ranges, Microwave Ovens, Trash Compactors, Room Air Conditioners, Dehumidifiers, Automatic Washers, Clothes Dryers, Freezers

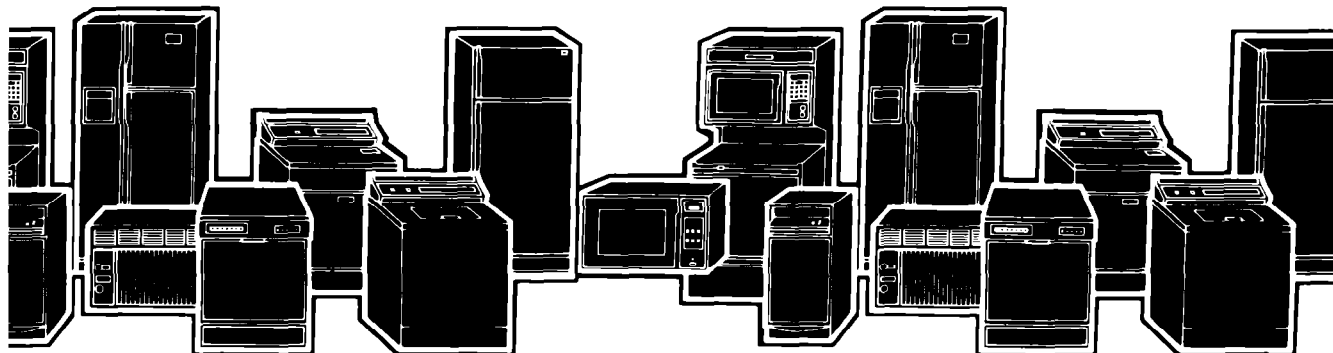

Contents

	Page		Page
Parts and Features	2	Defrosting	15
Before You Install Your Microwave Oven	3	Cooking Automatically After Defrosting	16
Before You Use Your Microwave Oven	3	Cooking with the Temperature Probe	18
Precautions to Avoid Possible Exposure to Excessive Microwave Energy	3	Using KEEP WARM	21
Important Safety Instructions	4	Other Operating Hints	22
Using Your Microwave Oven	5	Bi-Level Cooking	23
Microwave Oven Controls	5	Installation Instructions	24
Programming Tone	6	Grounding Instructions	25
Setting the Clock	6	Building in Your Microwave Oven	26
Using the Minute Timer	7	Caring for Your Microwave Oven	26
Cooking in Your Microwave Oven	8	Cleaning the Microwave Oven	26
Cooking at High Cook Power	8	Replacing the Light Bulb	26
Cooking at Lower Cook Powers	9	How Your Microwave Oven Works	27
Using AUTO SET	11	Operating Safety Precautions	28
Auto Set TIME	11	If You Need Service or Assistance	30
Auto Set TEMP	13	Microwave Oven Warranty	32

©1987 Whirlpool Corporation

Parts and features Model MW8650XS

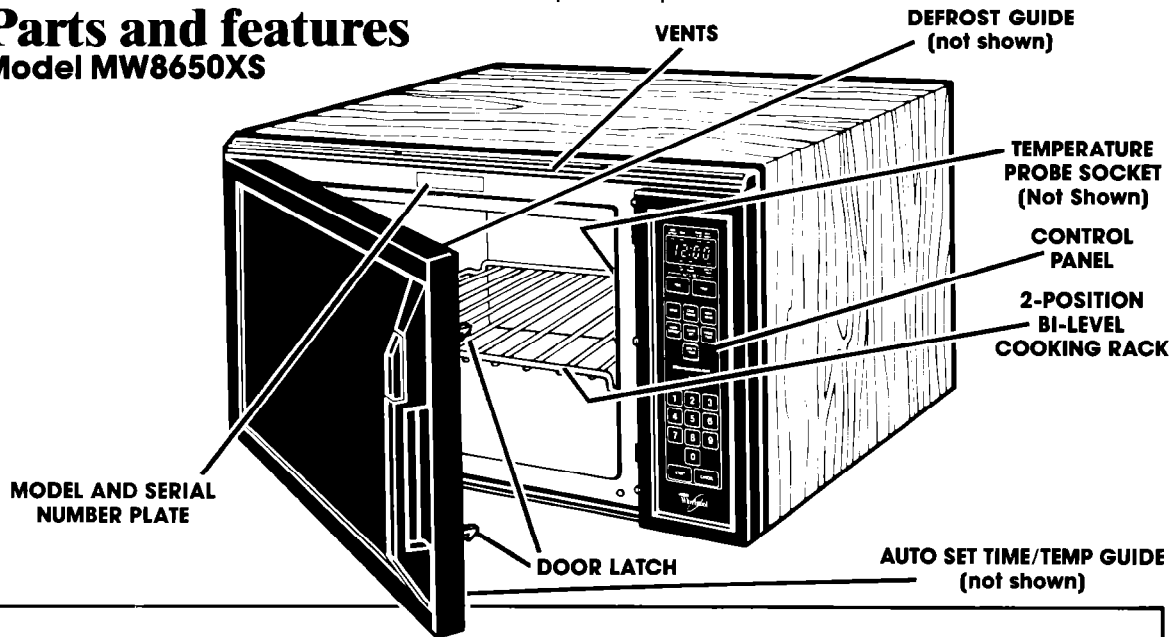

Copy your Model and Serial Numbers here...

If you need service or call with a question, have this information ready:

1. **Complete** Model and Serial Numbers (from the plate just behind the microwave oven door on the oven frame).
2. Purchase date from sales slip.

Copy this information in these spaces. Keep this book and your sales slip together in a handy place. **Please complete and mail the Owner Registration Card furnished with this product.**

Model Number

Serial Number

Purchase Date

Service Company Phone Number

Fill out and return the "Microwave Registration Card" included with your oven. If the card is missing, please send the model number of your microwave oven with your name and address to...

Whirlpool Corporation
Microwave Registration Department
Administrative Center
2000 M-63
Benton Harbor, Michigan 49022

This information will help us reach you if there is ever a need to pass along information about your microwave oven

Before you install your microwave oven

Read and carefully follow the "INSTALLATION INSTRUCTIONS" found on page 24 of this "Use & Care Guide."

Before you use your microwave oven

Read this "Use & Care Guide" carefully for important use and safety information. Store in a convenient place for future use.



It is your personal responsibility and obligation to be sure your microwave oven:

- Has been installed where it is protected from the elements. **The microwave oven should be at a temperature above 50°F (10°C) for proper operation.**
- Has been installed on a surface strong enough to support its weight.
- Has been properly connected to electrical supply and grounded. (See "Installation Instructions")
- Is not used by children or anyone unable to operate it properly.
- Is properly maintained.
- Is used only for jobs expected of a home microwave oven.

PRECAUTIONS TO AVOID POSSIBLE EXPOSURE TO EXCESSIVE MICROWAVE ENERGY...

DO NOT attempt to operate this oven with the door open since open-door operation can result in harmful exposure to microwave energy. It is important not to defeat or tamper with the safety interlocks.

DO NOT place any object between the oven front face and the door or allow soil or cleaner residue to accumulate on sealing surfaces.

DO NOT operate the oven if it is damaged. It is particularly important that the oven door close properly and that there is no damage to the

- (1) Door (bent),
- (2) Hinges and latches (broken or loosened),
- (3) Door seals and sealing surfaces.

DO NOT operate the microwave oven if the door window is broken.

The microwave oven should be checked for microwave leakage by qualified service personnel after a repair is made.

The oven should not be adjusted or repaired by anyone except properly qualified service personnel.

DO NOT operate the microwave oven with the outer cabinet removed.

IMPORTANT SAFETY INSTRUCTIONS

Microwave ovens have been used successfully in homes for a number of years. They are thoroughly tested for safe and efficient operation. However, as with any appliance, there are special installation and safety precautions which must be followed to ensure safe and satisfactory operation and prevent damage to the unit.



WARNING – To reduce the risk of burns, electric shock, fire, injury to persons or exposure to excessive microwave energy:

1. Read all instructions before using appliance
2. Read and follow the specific **“PRECAUTIONS TO AVOID POSSIBLE EXPOSURE TO EXCESSIVE MICROWAVE ENERGY”** found on page 3.
3. This appliance must be grounded. Connect only to properly grounded outlet. See **“GROUNDING INSTRUCTIONS”** found on page 25
4. Install or locate this appliance only in accordance with the provided **“INSTALLATION INSTRUCTIONS”** found on page 24
5. Some products such as whole eggs and sealed containers – for example, closed glass jars – may explode and should not be heated in this oven.
6. Use this appliance only for its intended use as described in this manual.
7. As with any appliance, close supervision is necessary when used by children.
8. Do not operate this appliance if it has a damaged cord or plug, if it is not working properly, or if it has been damaged or dropped. Electric shock, fire or other hazards may result.
9. This appliance should be serviced only by qualified service personnel. Call a Whirlpool authorized TECH-CARE® Service Company for examination, repair or adjustment.
10. Do not cover or block any opening on the appliance, for fire may result.
11. Do not use outdoors for damage to the oven or electric shock may result.
12. Do not immerse cord or plug in water for electric shock may result.
13. Keep cord away from heated surfaces for electric shock may result.
14. Do not let cord hang over edge of table or counter for electric shock may result.
15. See door surface cleaning instructions on page 26.
16. To reduce the risk of fire or fire in the oven cavity:
 - a. Do not overcook food. Carefully attend appliance if paper, plastic, or other combustible materials are placed inside the oven to facilitate cooking. Paper can char or burn, and some plastics can melt if used when heating foods.
 - b. Test dinnerware or cookware before using. See page 29. Some dishes (melamine, Centura,® etc.) absorb microwave energy, becoming too hot to handle and slowing cooking times. Remove wire twist-ties from paper or plastic bags before placing bag in oven. Cooking in metal containers can damage the oven. So can containers with hidden metal (twist-ties, foil lining, staples, metallic glaze or trim.)
 - c. If materials inside the oven should ignite, keep oven door closed, turn oven off, and disconnect the power cord, or shut off power at the fuse or circuit breaker panel.
17. Read and follow **“OPERATING SAFETY PRECAUTIONS”** starting on page 28.

SAVE THESE INSTRUCTIONS

Using your microwave oven

Microwave oven controls

There are three parts in the control section:

- The Digital Display/Clock, and Indicator Lights
- Command Pads
- Number Pads

Instructions for each control are covered on the following pages. Read them carefully.

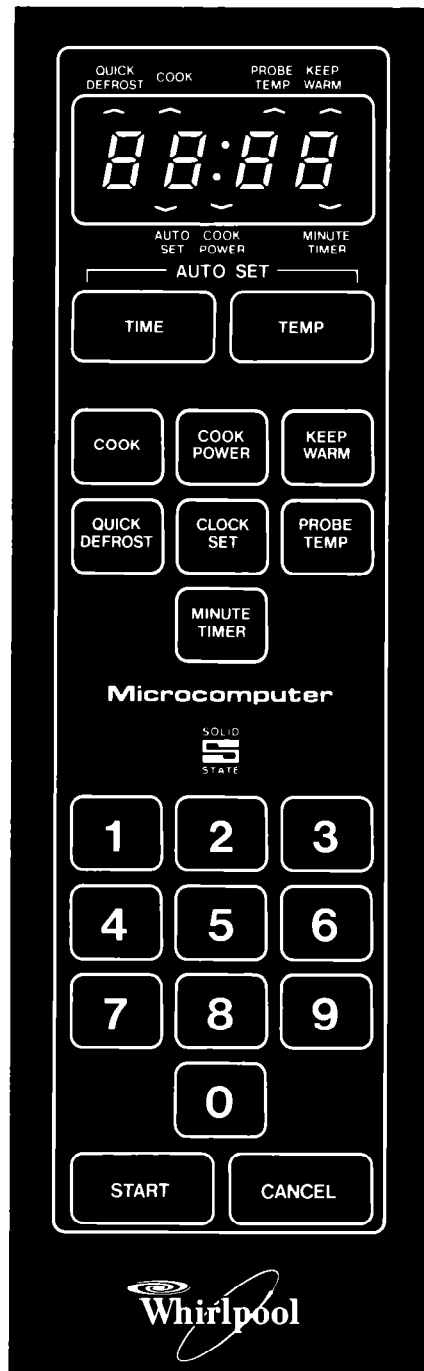

When you first plug in the oven, a tone sounds and the Display will show 88:88. If after you set the Clock (page 6), the Display again shows all 8's, your electricity was off for a while. Reset the Clock.

Digital display/clock and indicator lights



When you are not using the microwave oven, this is an accurate digital clock. When you are using the microwave oven, it displays time settings, indicator lights and shows what number pads you touched.

Command pads



Touch Command Pads to tell the microwave oven what to do and in what order. A few examples:

- CLOCK SET tells the oven you are going to set the clock.
- START tells the oven to start.

See page 6 for information on the tone you hear when touching any pad.

Each Command Pad, (except START, CANCEL and CLOCK SET) lights an Indicator Light on the digital display. The Indicator Light comes on when you touch the Command Pad.

While the oven is running, an Indicator Light (or lights) will be on to show what the oven is doing.

Number pads

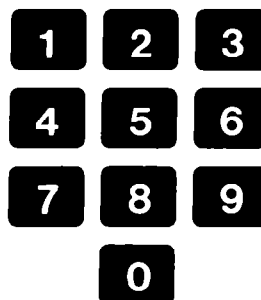

Once you've touched a Command Pad to tell the oven what you want it to do, you'll touch Number Pads to tell it...

- a time,
- a Cook Power,
- a food temperature.

Programming tone

Each time you touch a pad you will hear a tone. If you don't hear a tone, it is because the instruction is not correct, or because the tones have been removed.

EXAMPLE: If you touch a Number Pad before you touch a Command Pad, you will not hear a tone. The instruction is not correct.

If you want to remove the programming tone:

- Open the door.
- Touch CANCEL **twice**, then touch START.
- The tone will not sound for any **touch**.

If you want to replace the programming tone:

- Open the door.
- Touch CANCEL **twice**, then touch START.
- The tone will sound for any correct **touch**.

If you want to remove all tones, except the minute timer signal:

- Open the door.
- Touch CANCEL **twice**, touch 0, then touch START.
- All audible tones will be cancelled.
- **To replace the tones**, repeat the above steps.

Setting the clock

When the oven is first plugged in, a tone sounds and the display shows **88:88**. If the electric power ever goes off, the display will again show all 8's when the power comes back on.

You can cook or use the Minute Timer without setting the clock, but the display will be blank after cooking.

DO THIS...



1. Touch CLOCK SET.

THIS HAPPENS...

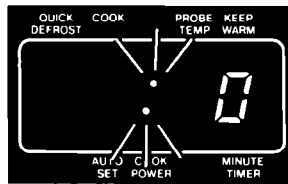

The Display will show a "0" and the colon will start to flash. **The first Number Pad must be touched within 5 seconds or the Display will go blank.** Touch CLOCK SET again and continue.



2. Touch Number Pads for the correct time of day.

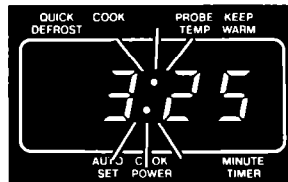

The Display will show what numbers you touched **in the order you touched them**. This example shows 3:25.



3. Touch START.



The colon will stop flashing. The Clock is set.



If you have touched in an incorrect time, such as 12:65, "Err" will show on the Display. Touch CLOCK SET and start over.

NOTE: To reset the clock, touch **CLOCK SET**. The current time will show on the Display and the colon will flash. Continue to set the clock as shown above.

Using the minute timer

The Minute Timer does not start or stop cooking. It can be used alone or while the oven is operating. It works like a kitchen timer.

DO THIS...



1. Touch MINUTE TIMER.



2. Touch Number Pads for minutes and seconds.



3. Touch START.

THIS HAPPENS...

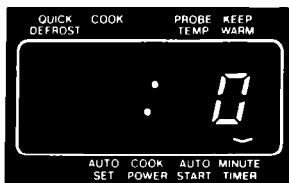

The Minute Timer indicator Light will come on and the Display will show a "0." **The first Number Pad must be touched within 5 seconds or the Display will again show the time of day.** Touch MINUTE TIMER again and continue.



The Display will show what numbers you touched **in the order you touched them**. This example shows 1 minute, 45 seconds.



The MINUTE TIMER indicator Light will stay on to show that the Minute Timer is running.

The Display counts down the seconds to show how much time is left on the Minute Timer.

When the set time is up, a 3 second signal will sound and the Display will show the time of day.

Changing the minute timer

- Touch MINUTE TIMER.
- Touch numbers to set new time.
- Touch START.

New instructions cancel the old ones.

Cancelling the minute timer.

- Touch MINUTE TIMER.
- Touch CANCEL. **Note.** Touch MINUTE TIMER before touching CANCEL to cancel just the Minute Timer. **If CANCEL is touched first, all cooking instructions will be cancelled and the Minute Timer will continue to operate.**

The Minute Timer can be set to time other activities while the oven is operating in any other cycle. The Display will countdown the time of the cycle in operation. The Minute Timer will continue to countdown, but will not show on the Display. When the time is up, a 3 second signal will sound.

Opening the oven door does not stop the Minute Timer countdown; however, it does stop any cooking or defrosting. Close the door and touch START to continue cooking or defrosting.

Cooking in your microwave oven

Be sure to read the **MICRO MENUS® Cookbook** packed with the microwave oven. It contains information about:

- What microwave energy is.
- How food is cooked by microwave energy.
- What affects cooking speed and cooking evenness.
- Safety tips.
- Utensils to use when cooking in a microwave oven.
- Cooking times for different foods.

Important things to remember to get the best cooking results.

- ALWAYS cook food for the minimum recommended cooking time. If necessary, add time in one or two minute periods, then check for doneness to avoid overcooking the food.
- Stir, turn or rearrange the food being cooked about halfway through the cooking time for most even doneness with all recipes.
- If a glass cover is not available, use waxpaper, paper towels or microwave approved plastic wrap. Turn back a corner to vent steam during cooking.

Cooking at high cook power

DO THIS...

THIS HAPPENS...

- 1. Put food in the oven and close the door.**



The COOK Indicator Light will come on and the Display will show four 0's.

- 2. Touch COOK.**



The Display will show the numbers you touched **in the order you touched them**. The example shows 1 minute, 30 seconds.

- 3. Touch Number Pads for the cooking time you want.**



The oven will automatically cook at high Cook Power.

The COOK Indicator Light will stay on to show that the oven is cooking in the first cycle.

- 4. Touch START.**

count
down



BEEP BEEP BEEP BEEP

The display counts down the time to show how much time is left in the first cycle.

When the cooking time ends, "End" will show on the Display and 4 beeps will sound. (You can stop the beeping by opening the door or by touching CANCEL.) "End" will remain on the Display and a beep will sound every 30 seconds (to remind you that food is left in the oven) until door is opened or CANCEL is touched. The Display will then show the time of day.

Changing the cooking time

Cooking time can be changed any time before touching START or during the cycle:

1. Touch COOK.
2. Touch numbers for the new time.
3. Touch START.

Cook will continue cooking for the new time.

Cooking at lower cook powers

For best results, some recipes call for lower Cook Powers. The lower the Cook Power, the slower the cooking. Each Number Pad also stands for a different percentage of Cook Power. Many recipes in your MICRO MENUS® Cookbook tell you, by number, which Cook Power to use. Recipes in other books and magazines may tell you by name (HI, MED, LO, etc.) or percentage (10%, 50%, 80%, etc.).

The following chart gives the percentage of Cook Power each Number Pad stands for, and Cook Power name usually used.

automatic 100% of full power	HIGH	4 = 40% of full power
9 = 90% of full power		3 = 30% of full power MED-LOW
8 = 80% of full power		2 = 20% of full power
7 = 70% of full power	MED-HIGH	1 = 10% of full power LOW
6 = 60% of full power		0 = no power (fan and light will be off)
5 = 50% of full power	MED	

DO THIS...

THIS HAPPENS...

1. Put food in the oven and close the door.



The COOK Indicator Light will come on and the Display will show four 0's.

2. Touch COOK.



The Display will show the numbers you touched **in the order you touched them**. This example shows 7 minutes, 30 seconds.

3. Touch Number Pads for the cooking time you want.

continued on next page

COOK
POWER

4. Touch COOK POWER.

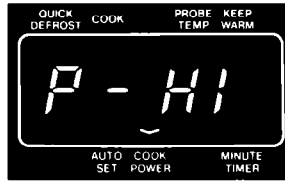

The COOK POWER Indicator Light will come on and the Display will show "P-HI." This shows the oven is preprogrammed to cook at full (HIGH) power.

5

5. Touch a Number Pad for the Cook Power you want.

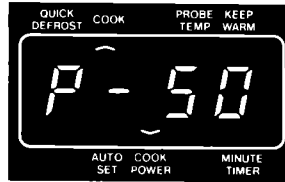

The Display will show what you touched. This example shows you touched Number Pad 5 for 50% of full power.

START

6. Touch START.

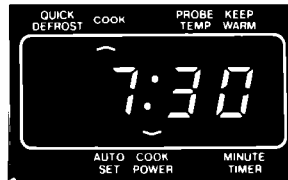

The COOK and COOK POWER Indicator Lights will stay on to show that the oven is cooking at a Cook Power other than high.

count
down

The Display counts down the time to show how much cooking time is left in the first cycle.



For 2 of every 10 seconds, the Display will show the Cook Power you selected.



When the cooking time ends, "End" will show on the Display and 4 beeps will sound. (You can stop the beeping by opening the door or by touching CANCEL.) "End" will remain on the Display and a beep will sound every 30 seconds (to remind you that food is left in the oven) until door is opened or CANCEL is touched. The Display will then show the time of day.

BEEP BEEP BEEP BEEP

Changing cook power

The **Cook Power** can be changed any time before touching START or during the cycle

- Touch COOK POWER.
 - Touch a number for the new Cook Power.
 - Touch START. The cycle will cook at the new Cook Power for the original time.
- OR...**
- Touch COOK POWER **twice** if you want to change a lower Cook Power to HIGH.
 - Touch START

Using AUTO SET

Auto Set TIME and TEMP are preset cooking cycles which store commonly used cooking times and probe temperature settings.

Auto Set TIME

Auto Set TIME provides ten preset times. One to nine minutes at HIGH cook power can be set by touching TIME and the corresponding number pad 1-9. This provides a short-cut method for setting commonly used cooking times.

The AUTO SET chart included with your microwave oven and the AUTO SET guide on the inner door panel help you use TIME to cook various food items without having to look up the cooking times.

A preset time of 2 minutes, 30 seconds at HIGH cook power is available by touching just the TIME pad. The time may be changed to any time from 0-99 minutes, 0-99 seconds allowing you to store your favorite cooking time and Cook Power. See page 12 for instructions.

DO THIS...

1. Put food in the oven and close the door.



2. Touch TIME
(Option: Skip to step 6 if you want to use the pre-set cooking time and Cook Power.)



3. Touch a Number Pad for the new cooking time you want from 1 to 9 minutes.



4. Touch COOK POWER.
(Option: Skip to step 6 if you want to cook at high power.)

THIS HAPPENS...



The AUTO SET Indicator Light will come on and the Display will show 2 minutes, 30 seconds (or the time you have set as your favorite cycle).



The Display will show what you touched in even minutes. This example shows 4 minutes.



The COOK POWER Indicator Light will come on and the Display will show "P-HI." This shows the oven is pre-programmed to cook at full (HIGH) power.

continued on next page

5

5. Touch a Number pad for the Cook Power you want.

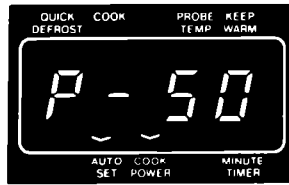

The Display will show what you touched. This example shows you touched Number Pad 5 for 50% of full power.

START

6. Touch START.



The AUTO SET Indicator Light will stay on while the oven is cooking in the preprogrammed cycle. If you selected a Cook Power other than high, the Cook Power Signal Light will also come on. This shows you the oven is cooking at a selected Cook Power.

count
down

The Display counts down the time to show how much cooking time is left.



For 2 of every 10 seconds, the Display will show the Cook Power you selected, if you are using a Cook Power other than high.



When Auto Set ends, "End" will show on the Display and 4 beeps will sound. (You can stop the beeping by opening the door or by touching CANCEL.) "End" will remain on the Display and a beep will sound every 30 seconds (to remind you that food is left in the oven) until the door is opened or CANCEL is touched. The Display will then show the time of day.

BEEP BEEP BEEP BEEP

You can set COOK to follow Auto Set TIME, if desired. Touch in instructions for "Cooking in your microwave oven," page 8; or "Cooking at lower cook powers," page 9.

Changing the pre-programmed setting

You can change the pre-programmed cooking time and Cook Power in AUTO SET TIME to the time and power you most often use. To change the AUTO SET TIME setting, follow these steps.

1. Place food in the oven and close the door.
2. Touch TIME twice.
3. Touch the Number Pads for the new desired cooking time. If high Cook Power is desired, skip to Step 6.
4. Touch COOK POWER.
5. Touch the Number Pad for the desired Cook Power.
6. Touch START. The oven will cook at the new cooking time and Cook Power you selected. After the cooking is complete, the oven will remember that time and Cook Power for future use. **NOTE: If the electric power ever goes off, the oven will go back to the pre-programmed 2 minutes, 30 seconds at high Cook Power setting.**

Auto Set TEMP

Auto Set TEMP provides ten preset probe temperature settings. One hundred ten (110) to one hundred ninety (190) degrees at 70% cook power can be set by touching TEMP and the corresponding number pad 1-9. This provides a short-cut method for setting commonly used probe temperatures. The AUTO SET chart included with your microwave oven and the AUTO SET guide on the inner door panel help you use TEMP to cook various food items without having to look up the temperature.

A preset temperature of 165°F at HIGH cook power is available after inserting the probe by touching just the TEMP pad. This temperature may be changed to any temperature from 90°F to 200°F allowing you to store your favorite cooking temperature and cook power. See page 14 for instructions.

DO THIS...

1. Put food in the oven and close the door.



2. Touch TEMP.
(Option: Skip to step 6 if you want to use the preset temperature and Cook Power.)

THIS HAPPENS...



The AUTO SET Indicator Lights will come on and the Display will show 165°F (or the temperature you have programmed as your favorite cycle).



3. Touch a Number Pad for the new temperature you want from 110°F to 190°F.



The Display will show what you touched in degrees Fahrenheit. This example shows 140°F. **NOTE: Cook Power of 70% is preset on TEMP settings 1-9.**



4. Touch COOK POWER.
(Option: Skip to Step 6 if you want to cook at 70% power.)

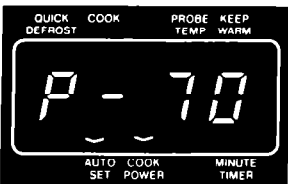

The COOK POWER Indicator Light will come on and the Display will show "P-70."



5. Touch a Number Pad for the Cook Power you want.



The Display will show what you touched. This example shows you touched Number Pad 5 for 50% of full power.

continued on next page

6. Touch START.



The AUTO SET and PROBE TEMP Indicator Lights will stay on. The Display will show "COOL" to show the food is less than 90°F. As the food cooks the Display will show the internal temperature of the food for every 5°F increase.



For 2 of every 10 seconds, the Display will show the Cook Power you selected, if you are using a Cook Power other than high.



When the probe senses the temperature you selected, the oven shuts off. "End" will show on the Display and 4 beeps will sound. (You can stop the beeping by opening the door or by touching CANCEL.) "End" will remain on the Display and a beep will sound every 30 seconds (to remind you that food is left in the oven) until door is opened or CANCEL is touched. The Display will then show the time of day.

BEEP BEEP BEEP BEEP

NOTE: You can set Auto Set TEMP to follow COOK.

Auto Set TEMP can be programmed with the temperature probe out, but the oven will pause between the last Cook cycle and TEMP. "PROB" will show on the Display to remind you to plug in the probe.

Changing the pre-programmed setting

You can change the pre-programmed temperature and Cook Power in Auto Set TEMP to the temperature and power you most often use. To change the Auto Set TEMP setting, follow these steps:

1. Insert at least $\frac{1}{3}$ of the temperature probe into the food.
2. Place food in the oven and close the door.
3. Touch TEMP twice.
4. Touch the Number Pads for the new desired temperature between 90°F and 200°F. If high Cook Power is desired, skip to Step 6.
5. Touch COOK POWER.
6. Touch the Number Pad for the desired Cook Power.
7. Touch START. The oven will cook to the new temperature at the Cook Power you selected. After the cooking is complete, the oven will remember that temperature and Cook Power for future use. **NOTE: If the electric power goes off, the oven will go back to the pre-programmed 165°F at high Cook Power setting.**

Additional information:

- Temperature may be changed after START is touched by touching TEMP, the new number and START.
- Auto Set TEMP will follow the COOK cycle if programmed.
- "PROB" will show on the Display after START is touched if the probe is not plugged into the oven. This will **only** appear when Auto Set TEMP has been selected alone, or between the last COOK cycle and Auto Set TEMP selection.
- "ERR" will show on the Display after START is touched, if an incorrect temperature has been selected (under 90°F or over 200°F).
- See "Hints for using the temperature probe" on pages 18 and 19.

Defrosting

Use QUICK DEFROST to thaw frozen food before cooking. For suggested defrost times, see the guide behind the oven door or in your MICRO MENUS® cookbook.

DO THIS...

1. Put frozen food in the oven and close the door.



2. Touch QUICK DEFROST.



3. Touch Number Pads for the defrosting time you want.



4. Touch START.

THIS HAPPENS...



The QUICK DEFROST Indicator Light will come on and the Display will show four 0's.



The Display will show the number you touched **in the order you touched them**. This example shows 2 minutes, 45 seconds.



The QUICK DEFROST Indicator Light will stay on to show that the oven is in the Quick Defrost Cycle.

The Display counts down the time to show how much defrosting time is left.



BEEP BEEP BEEP BEEP

When the defrost time ends, "End" will show on the Display and 4 beeps will sound. (You can stop the beeping by opening the door or by touching CANCEL.) "End" will remain on the Display and a beep will sound every 30 seconds (to remind you that food is in the oven) until door is opened or CANCEL is touched. The Display will then show the time of day.

Standing time

For best results, allow the food to stand for a while after defrosting. This helps equalize the temperature of the food to provide more even defrosting.

When COOK follows QUICK DEFROST, the oven automatically provides a standing time equal to the time touched in for QUICK DEFROST. COOK will begin after the automatic standing time.

About the "QUICK DEFROST" Cycle

The microwave oven automatically divides the time set for the QUICK DEFROST Cycle into three equal parts:

First part	80% of full Cook Power
Second part	50% of full Cook Power
Third part	20% of full Cook Power

This automatic step-down in Cook Power helps defrost food quickly and completely.

Changing or adding defrost time

You can change the defrosting time any time before or after touching START.

- Touch QUICK DEFROST.
- Touch numbers for new time.
- Touch START.

Any new time setting made while QUICK DEFROST is operating will continue the defrosting at only 20% of full power.

The best time to change the setting is near the end of the QUICK DEFROST Cycle.

- Open the door.
- Check the food with long-tined fork; if center area is hard frozen, set additional time.
Remember that standing time is necessary to complete defrosting.
- Close the door and touch START to continue the cycle if no additional time is needed.
OR...
- Touch in new instructions for additional defrosting time.

Cooking automatically after defrosting

The controls can be set so the microwave oven goes automatically from defrosting to the Cook Cycle you have touched in.

DO THIS...

THIS HAPPENS...

1. Put food in the oven and close the door.



2. Touch QUICK DEFROST.

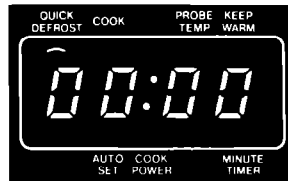

The QUICK DEFROST Indicator Light will come on and the Display will show four 0's.



3. Touch Number Pads for the defrosting time you want.



The Display will show the numbers you touched **in the order you touched them**. This example shows 4 minutes, 30 seconds.



4. Touch COOK.



The COOK Indicator Light will come on and the Display will show four 0's.



5. Touch Number Pads for the Cooking time you want.



The Display will show the numbers you touched **in the order you touched them**. This example shows 2 minutes, 30 seconds.

**COOK
POWER**

- 6. Touch COOK POWER.**
(Options: Skip to 8 if you want to cook at high power.)



The COOK POWER Indicator Light will come on and the Display will show "P-HI." This shows the oven is preprogrammed to cook at full (HIGH) power.

6

- 7. Touch a Number Pad for the Cook Power you want.**



The Display will show what you touched. This example shows you touched Number Pad 6 for 60% of full power.

START

- 8. Touch START.**



When you touch START, the QUICK DEFROST Indicator Light will stay on. All other Indicator Lights will go off. The Display counts down the time to show how much time is left in the defrost cycle.

**count
down**

When the defrost time ends, the microwave oven automatically lets the food stand for the **same amount of time used for defrosting**. The QUICK DEFROST Indicator Light stays on and the Display counts down the standing time. **During the countdown the oven will be dark, and the fan will be off.**

BEEP BEEP

When the standing time is over, you will hear 2 beeps and the cooking cycle will start.



The COOK Indicator Light will be on during the cooking cycle. The COOK POWER Indicator Light will also be on **if you are using a Cook Power other than high.**

**count
down**

The Display counts down the time to show how much time is left in the second cycle.



For 2 of every 10 seconds, the Display will show the Cook Power you selected, if you are using a Cook Power other than high.

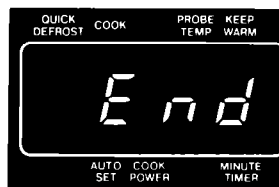

When the Cook cycle ends, "End" will show on the Display and 4 beeps will sound. (You can stop the beeping by opening the door or by touching CANCEL.) "End" will remain on the Display and a beep will sound every 30 seconds (to remind you that food is left in the oven) until door is opened or CANCEL is touched. The Display will then show the time of day.

BEEP BEEP BEEP BEEP

Cooking with the TEMPERATURE PROBE

The Temperature Probe helps take guesswork out of cooking roasts and larger casseroles. The probe is designed to turn off the oven when it senses the temperature you chose. See your MICRO MENUS® Cookbook for helpful information in cooking different types of food.

DO THIS...

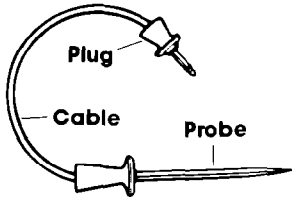

1. Insert at least $\frac{1}{3}$ of the temperature probe into the food.

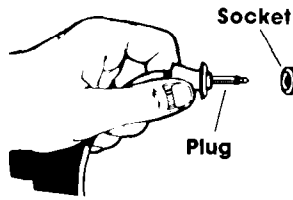

2. Place food in the oven and plug the probe into the socket on the oven wall.

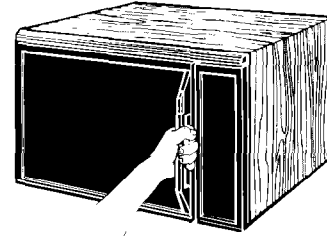

3. Make sure the probe does not touch any part of the oven interior. Close the door.

DO THIS...



4. Touch PROBE TEMP.

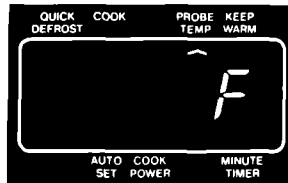

The PROBE TEMP Indicator Light will come on and the Display will show "F."



5. Touch Number Pads for the desired final temperature between 90°F and 200°F.



The Display will show the numbers you touched **in the order you touched them**. This example shows a final cooked temperature of about 140 F.



6. Touch COOK POWER (Option: Touch START if you want to use high power.)

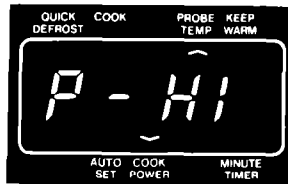

The COOK POWER Indicator Light will come on and the Display will show "P-HI." This shows the oven is pre-programmed to cook at full (HIGH) power.



7. Touch the Number Pad for the Cook Power you want.

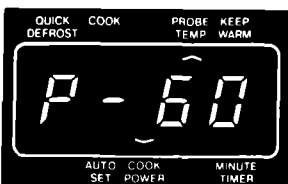

The Display will show what you touched. This example shows you touched Number Pad 6 for 60% of full power.

8. Touch START.

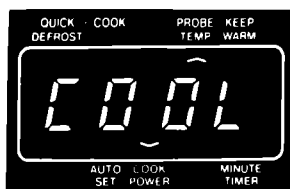

BEEP BEEP BEEP BEEP

The PROBE TEMP and COOK POWER Indicator Lights will stay on.

The Display will show "COOL" to show the food is less than 90°F. As the food cooks, the Display will show the internal temperature of the food for every 5°F increase.

For 2 of every 10 seconds, the Display will show the Cook Power you selected, if you are using a Cook Power other than high.

When the probe senses the temperature you selected, the oven shuts off. "End" will show on the Display and 4 beeps will sound. (You can stop the beeping by opening the door or by touching CANCEL.) "End" will remain on the Display and a beep will sound every 30 seconds (to remind you that food is left in the oven) until door is opened or CANCEL is touched. The Display will then show the time of day.

NOTE: "Err" will be displayed after START is touched, if an incorrect temperature has been selected (under 90°F or over 200°F).

Hints for using the temperature probe

DO...

- use hot pads when removing probe from food or food from oven.
- stir foods during cooking when recommended.
- stir soups, casseroles and drinks before serving.
- cover roasts with foil and let stand a few minutes after cooking. Remove foil if you decide to cook it longer.
- remove the probe from the oven when not cooking by temperature.

DON'T...

- let probe or probe cable touch any part of the oven interior.
- let probe touch foil (if used). Foil can be kept away from probe with wooden toothpicks. Remove foil if arcing occurs.
- use paper, plastic wrap or plastic containers. They will be in the oven too long.
- use probe in regular oven.
- force probe into frozen food.
- use probe for foods that need to simmer.

NOTE: Some foods are started using a timed (COOK) cycle and finished by using a temperature (PROBE TEMP) cycle. You can set PROBE TEMP to follow COOK, to avoid the need to reset the oven halfway through cooking. PROBE TEMP can be programmed with the temperature probe out. The oven will then pause between COOK And PROBE TEMP. "PROB" will show on the Display to remind you to plug in the probe. Touch START to continue cooking.

Changing the temperature setting

- When using the Temperature Probe, PROBE TEMP settings can be changed before or during operation:
 - Touch PROBE TEMP.
 - Touch number for new temperature.
 - Touch START. The oven will continue cooking to the new temperature. If the new temperature is lower than the temperature of the food, the oven will shut off.

Temperature probe cooking tips

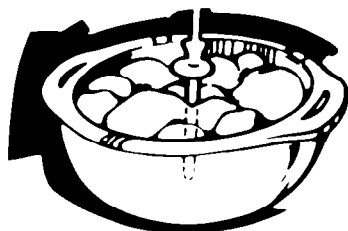

For casseroles, the tip of the probe should be in the center of the food. Stir foods when recommended. Replace the probe.

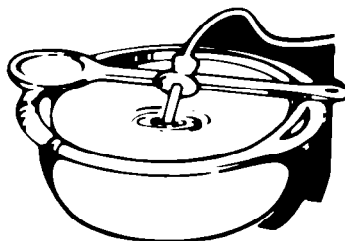

For liquids, balance the probe on a wooden spoon or spatula so the tip of the probe is in the center of the liquid.

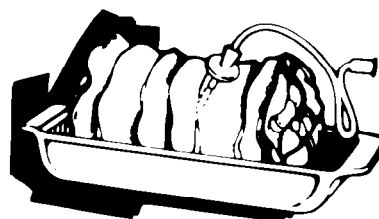

For roasts, the tip of the probe should be in the center of the largest muscle, but not touching fat or bone.

- Casseroles cooked using the Temperature Probe should be made from precooked foods. Do not use raw meats, raw vegetables and cream sauces in casseroles.
- Dry casseroles do not work well.
- Thaw frozen casseroles and meats in the microwave oven before inserting the probe.
- If you are cooking individual servings such as mugs of soup, check the probe setting in several of the items – all the mugs may not heat at the same rate.
- Dry meat loaf mixtures don't work well.
- Remember that roasts may vary in size, shape and composition. Use the timings for minutes per pound as a guide as well as the Temperature Probe.

Cleaning the probe

1. Remove probe from microwave oven using hot pads.
2. Wipe probe with a hot sudsy cloth. Use a plastic scouring pad to remove stubborn foods.
3. Probe may be placed in the silverware basket of the dishwasher.

Using KEEP WARM

Hot, cooked foods can be safely kept warm in your microwave oven for up to 99 minutes, 99 seconds (about 1 hour, 40 minutes). KEEP WARM can be used by itself, or it can automatically follow a cooking cycle or PROBE TEMP cycle.

DO THIS...

THIS HAPPENS...

1. Put cooked, hot food in oven and close door.



The KEEP WARM Indicator Light will come on. The Display will show the time of day.

2. Touch KEEP WARM.



The KEEP WARM Indicator Light will stay on. The Oven light and the fan will come on. The Display will continue to show the time of day.

3. Touch START.

- KEEP WARM operates for up to 99 minutes, 99 seconds.
- Opening the oven door cancels KEEP WARM. Close the door and touch KEEP WARM, then START if additional KEEP WARM time is desired.
- Foods cooked covered should be covered during KEEP WARM.
- Pastry items (pies, turnovers, etc.) should be uncovered during KEEP WARM.
- Complete meals kept warm on a dinner plate should be covered during KEEP WARM.
- The use of more than one complete KEEP WARM (about 1 hour, 40 minutes) is not recommended. The quality of some foods will suffer with extended time.

To automatically follow another cycle

- **While you are touching in cooking instructions**, touch KEEP WARM before touching START.
- **OR...**
- **After the oven starts operating**, touch KEEP WARM and then START.
- When the last cooking cycle is over you will hear 4 beeps. The KEEP WARM Indicator Light will come on and the time of day will be displayed while the oven continues to run.
- KEEP WARM will follow AUTO SET, QUICK DEFROST, COOK or PROBE TEMP.

Other operating hints

1. To double check settings while the oven is running:

- Touch the Command Pad for the setting you want to check. The instruction programmed for that pad will show on the display for 5 seconds. Then the display returns to showing what the oven is doing.

2. To stop the oven while it is running:

- Open the door. The oven will stop. Restart the oven by closing the door and touching START.
- Touch CANCEL. All instructions will be erased. You must touch in new instructions.

3. If you touch two instructions into the same cycle, the second set of instructions will cancel the first.

Bi-level cooking rack

Use the metal Bi-Level Cooking Rack when cooking in more than one container. The metal rack can be turned upside-down to help fit taller containers on the bottom of the oven. See the MICRO MENUS® Cookbook provided with your oven.

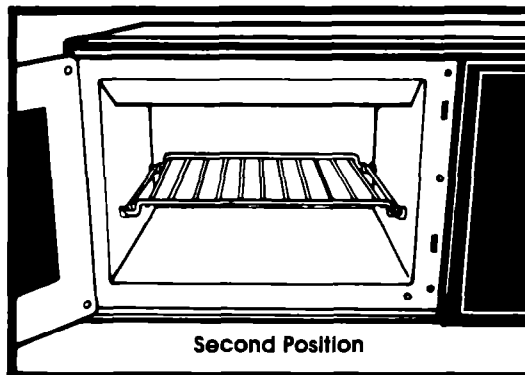
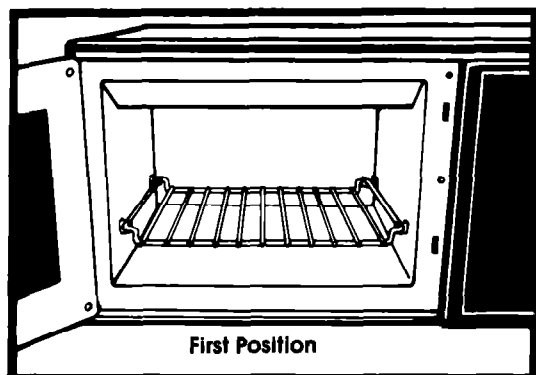

Note: Do not store the metal rack in the oven. Arcing and damage to the oven can result if someone accidentally starts the oven.

Inserting the rack

- Insert the rack securely into the rack supports on the side walls of the oven. (First position)
- Turn rack upside-down when using a taller container on the bottom of the oven. (Second position)
- **Do not** operate the oven with the metal rack stored on the floor of the oven. Damage to the interior finish will result.

Cleaning the rack

- Wash by hand with a mild detergent and a soft or nylon scrub brush. Dry completely.
- **Do not** use abrasive scrubbers or cleansers.

Special caution

- **Do** use hot pads when removing rack from oven after cooking. It may be hot.
- **Do** put food in containers, then place containers on rack.
- **Do** use only when cooking foods in more than one container.
- **Do** use only in the microwave oven.
- **Do not use with browning dish.**
- **Do not** let food container touch the top or side of the oven.
- **Do not store rack in oven.**
- **Do not** cook foods directly on rack without putting them in containers first.

Installation instructions

BEFORE YOU BEGIN, READ THE FOLLOWING INSTRUCTIONS COMPLETELY AND CAREFULLY.

Installing your microwave oven

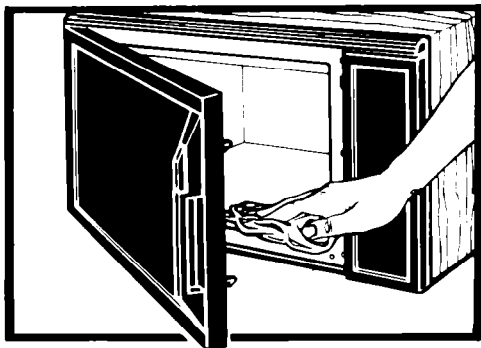

1. Empty the microwave oven and clean inside it with a soft, damp cloth. Check for damage such as misaligned door, damage around the door or dents inside the oven or on the exterior. If there is any damage, please do not operate the unit until it has been checked by an authorized Whirlpool service technician and any repairs made.

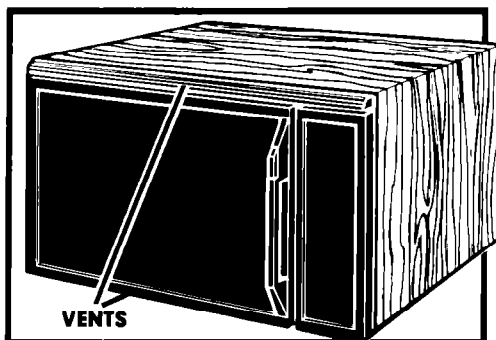

3. Do not block the vent opening at the front of the oven or the air intake opening on the bottom of the oven. Blocking vent or air intake openings can cause poor cooking results.

Make sure the microwave oven legs are in place. Do not set the oven on anything that will block the air intake openings.

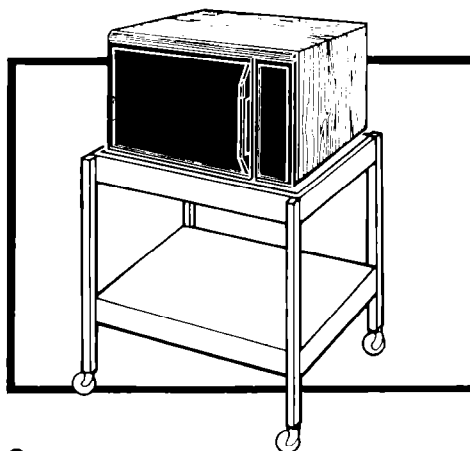

2. Put the oven on a cart, counter, table or shelf that is strong enough to hold the oven, the food and the utensils you put in it. **(The control side of the unit is the heavy side. Use care when handling.)** The weight of the oven is approximately 60 lbs. (27 kg).

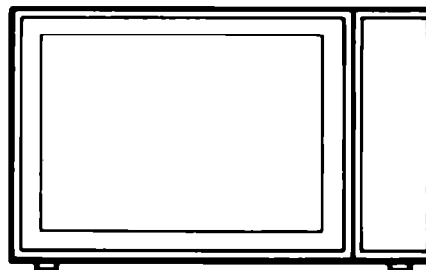

4. Do not install the oven next to a conventional surface unit or in any area where excessive heat and steam are generated. This could damage the outside of the cabinet.

5. Electrical requirements

Observe all governing codes and ordinances.

A 120 Volt, 60 Hz., AC only, 15 or 20 amp fused electrical supply is required. (Time-delay fuse is recommended.) It is recommended that a separate circuit serving only this appliance be provided.

6. GROUNDING INSTRUCTIONS

WARNING: Improper use of the grounding plug can result in a risk of electrical shock.

DO NOT, UNDER ANY CIRCUMSTANCES, REMOVE THE POWER SUPPLY CORD GROUNDING PRONG.

7. For your personal safety, this appliance must be grounded. In the event of an electrical short circuit, grounding reduces the risk of electric shock by providing an escape wire for the electric current. This appliance is equipped with a

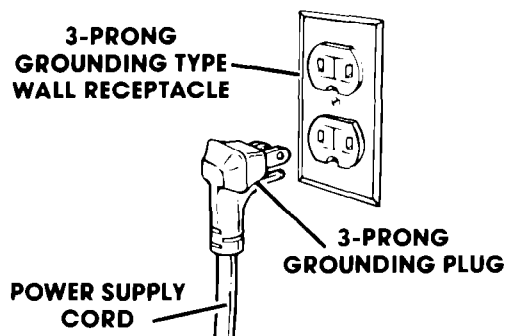

polarized 3-prong grounding plug. It must be plugged into a correct polarized mating 3-prong grounding type wall receptacle, properly installed and grounded in accordance with the National Electrical Code and local codes and ordinances. If a mating wall receptacle is not available or if you are not sure if the

wall receptacle is properly grounded and polarized, have it checked by a qualified electrician.

It is the personal responsibility and obligation of the customer to have a properly grounded and correctly polarized 3-prong wall receptacle installed by a qualified electrician.

Consult a qualified electrician if the grounding instructions are not completely understood, or if doubt exists as to whether the appliance is properly grounded.

It is NOT recommended to use an extension cord with your microwave oven, but if you find it necessary to do so temporarily (until a properly grounded and polarized 3-prong receptacle is installed), use only a heavy duty UL listed 3-wire grounding type extension cord containing three 16-gauge (minimum) copper wires. It must not be longer than 10 feet (cords longer than 10 feet may affect the cooking performance of your microwave oven). The plug on the extension cord must fit into a 3-prong grounding type wall receptacle (as shown on this page) and the receptacle end of the extension cord must accept the 3-prong grounding plug of the microwave oven.



8. Plug the oven into the proper electrical outlet and put about one cup (250 mL) of cold water in a glass container in the oven. Close the door. Make sure it latches. Follow the directions on page 6 to set the oven to COOK for 1½ minutes. When the time is up, the water should be heated.

9. **This microwave oven is designed for use in the household only and must not be used for commercial purposes.**

DO NOT remove the outer case, door, or control panel at any time. The unit is equipped with high voltage and should not be serviced unless by an authorized Whirlpool trained service technician.

SAVE THESE INSTRUCTIONS

Building in your microwave oven

Your microwave oven is not limited to carts, counters or tables. Custom installations are made easy with kits available from your dealer.

1. Build the microwave oven into a cabinet or wall by itself or over built-in single ovens in the Whirlpool RDE, REE, RGE, RB and SB model series.
2. Attach the microwave oven to a wall by itself or with cabinets over it.
3. Put the microwave oven on the **MICRO SHELF®** Hood over a cooktop. The hood is available ducted or as a recirculating hood, and includes cooktop lights.

Ask your dealer for details on...

- 832987 – 30-inch Built-in Kit
- 832989 – 24-inch Built-in Kit
- 832991 – 27-inch Built-in Kit
- 832993 – Wall Mounting Kit
- RH3330XR – MICRO SHELF® Hood

Use only approved installation kits. Obtain these kits from your authorized Whirlpool dealer.

Caring for your microwave oven

Cleaning the microwave oven

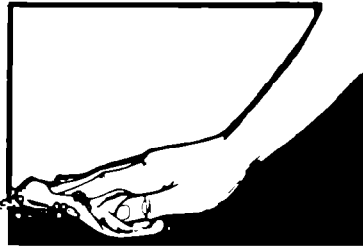

Wipe often with warm sudsy water and a soft cloth or sponge.

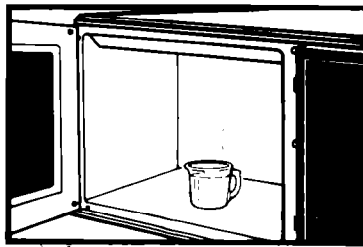

For stubborn soil, boil a cup of water in the oven for 2 or 3 minutes. Steam will soften the soil.

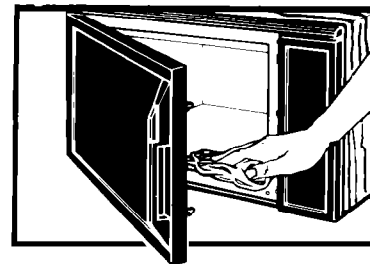

Be sure to clean the areas where the door and oven frame touch when closed. When cleaning surfaces of door and oven that come together on closing the door, use only mild, non-abrasive soaps or detergents applied with a sponge or soft cloth. Rinse well.

CAUTION:

Abrasive cleansers, steel wool pads, gritty wash cloths, etc., can damage the control panel, and the interior and exterior oven surfaces. Use a soft cloth or a sponge with a mild detergent or spray glass cleaner.

Replacing the light bulb

The microwave oven light should come on whenever the door is opened or the oven is operating.

To replace:

1. Unplug, or turn off at fuse box or circuit breaker.
2. Open the oven door.
3. Remove the 3 screws from the front of the cover.
4. Pull down the front portion of the cover. (It is creased across its width to form a hinge.)
5. Remove and replace the 25-watt candelabra-base bulb (Part No. 313969). Obtain bulb from your authorized Whirlpool dealer.
6. Close the cover and replace the screws.
7. Plug in, or turn on the main power supply.

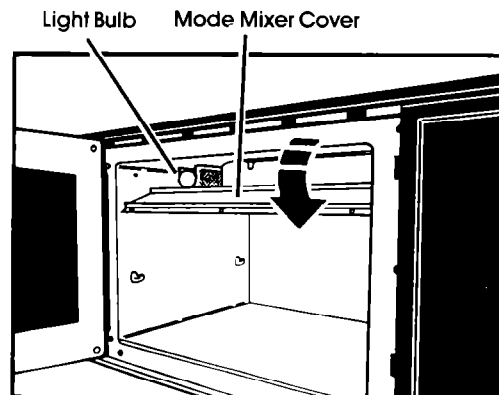

How your microwave oven works

Microwave ovens are safe. Microwave energy is not hot. It causes food to make its own heat, and it's this heat that cooks the food.

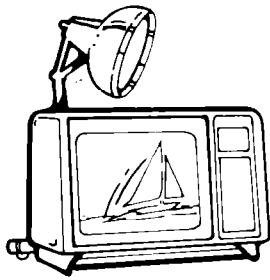

Microwaves are like TV waves or light waves. You can't see them, but you can see what they do.

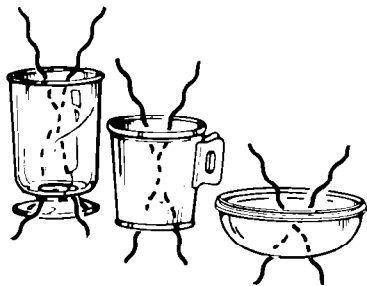

Microwaves pass through glass, paper and plastic without heating them so food absorbs the energy. Microwaves bounce off metal pans so food does not absorb the energy.

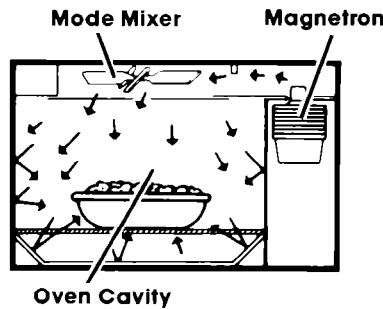

A magnetron in the microwave oven produces microwaves. The microwaves move into the oven where they are scattered or stirred by a mode mixer (like a fan). Microwaves bounce off metal oven walls and are absorbed by food.

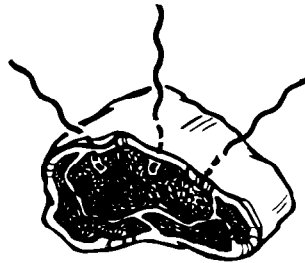

Microwaves may not reach the center of a roast. The heat around the outside is what cooks the roast all the way through. This is one of the reasons for letting some foods (roasts, baked potatoes) stand for a while after cooking, or for stirring some foods during the cooking time.

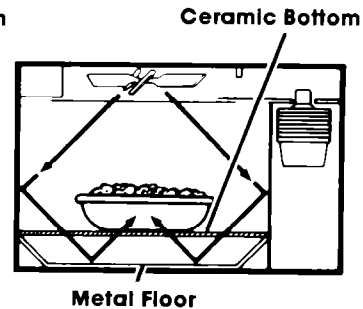

The ceramic bottom of your microwave oven lets microwaves through. Then they bounce off a metal floor, back through the ceramic bottom and are absorbed by the food.

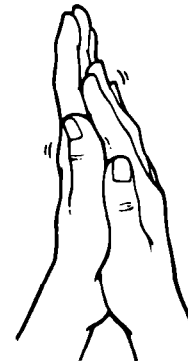

The microwaves disturb water molecules in the food. As the molecules bounce around bumping into each other, heat is made, like rubbing your hands together. This is the heat that cooks.

Operating safety precautions



WARNING: DO NOT use oven until you have read and understand **ALL** the information on safe use.

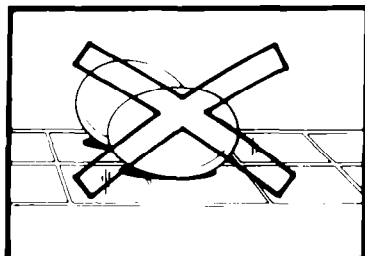

NEVER COOK OR REHEAT A WHOLE EGG.

Steam build-up in whole eggs may cause them to burst and burn you, and possibly damage the oven. Slice hard boiled eggs before heating. In rare instances, poached eggs have been known to explode. Cover poached eggs and allow a standing time of one minute before cutting into them.

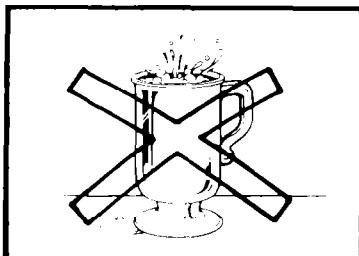

Liquids heated in certain containers (especially cylindrical-shaped containers) may become overheated. The liquid may splash out with a loud noise during or after heating or when adding ingredients (coffee, etc.) resulting in harm to the oven and possible personal injury. For best results stir any liquid several times before heating or reheating.

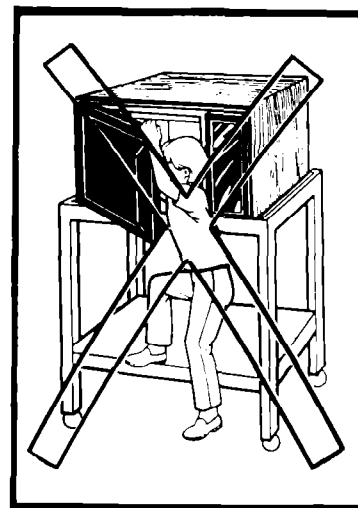

NEVER lean on the door or allow a child to swing on it when the door is open. Injury could result.

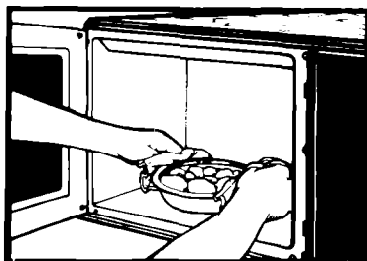

USE HOT PADS. Microwave energy does not heat containers, but the hot food does.

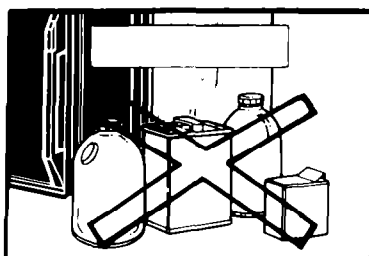

DO NOT heat, store or use flammable or inflammable materials in or near the oven.

DO NOT can foods in the oven. Closed glass jars may explode resulting in damage to the oven or possible personal injury.

DO NOT use the oven to sterilize objects (baby bottles, etc.). It is difficult to maintain the high temperature required for safe sterilization.

CAUTION: DO NOT use the oven until you have read and understand **ALL** precautions to prevent damage to the oven.

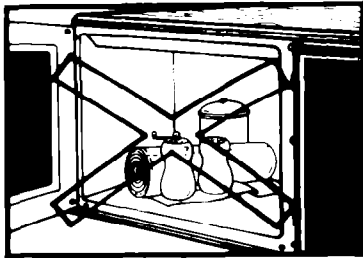

DO NOT use the oven for storage. Do not leave paper products, books or cooking utensils in the oven when not in use. Fire may result if someone accidentally starts the oven. Don't let anything touch the top of the oven.

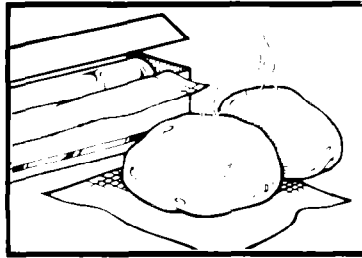

DO NOT OVERCOOK POTATOES. Fire could result. At the end of the recommended cooking time they should be slightly firm. Wrap in foil and set aside for 5 minutes. They will finish cooking while standing.

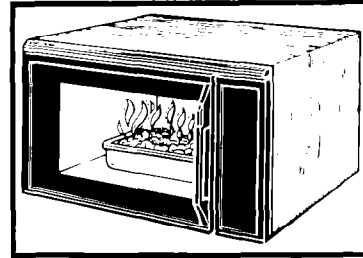

If a fire should start in the oven cavity:

- **keep door closed**
- **turn oven off**
- **disconnect the power supply** at the cord, fuse box or circuit breaker.

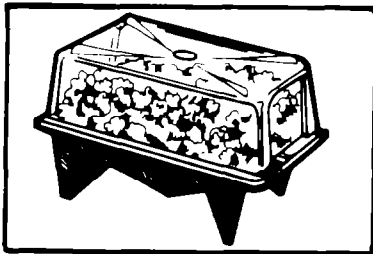

DO NOT pop popcorn, except in a microwave-approved popcorn popper or commercial package designed especially for microwave ovens. Results are the manufacturers responsibility. **NEVER** try to pop corn in a paper bag. Overcooking may result in smoke and fire.

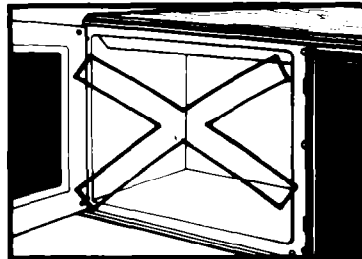

Starting a microwave oven when it's empty is not recommended. If you experiment, put a container of water in the oven.

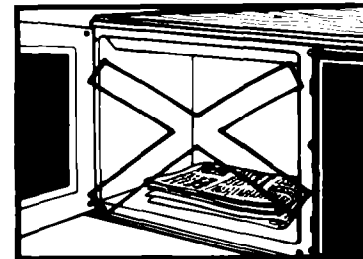

DO NOT use newspaper or other printed paper in the oven. Fire could result.

DO NOT dry flowers, fruit, herbs, wood, paper, gourds or clothes in the oven. Fire or other hazards may result.

General information

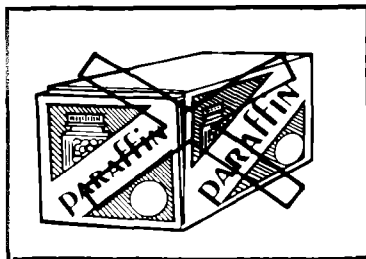

DO NOT try to melt paraffin wax in the oven. Fire or other hazards may result.

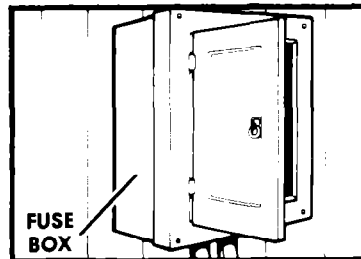

If your electric power line voltage is less than the normal 120 volts, cooking times may be longer.

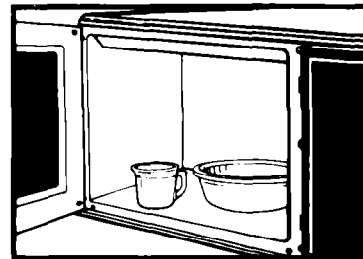

To test a dish for safe use, put it into the oven with a cup of water **beside it**. Cook on high Cook Power for one minute. **If the dish gets hot and water stays cool, do not use it.**

If you need service or assistance, we suggest you follow these five steps:

1. Before calling for assistance...

Performance problems often result from little things you can find and fix yourself without tools of any kind.

If nothing operates:

- Is the power supply cord plugged into a live circuit with the proper voltage? (See page 25.)
- Have you checked your home's main fuse or circuit breaker box?
- Have you checked the electric company for a power failure?

If the microwave oven will not run:

- Is the oven being used as a timer?
- If the Temperature probe is being used, is it plugged tightly into its socket?
- Is the door firmly closed and latched?
- Did you touch START?
- Did you follow the directions exactly?

If the microwave cooking times seem too long:

- Is the electric supply to your home low or lower than normal? Your electric company can tell you if the line voltage is low.
- Is the Cook Power at the recommended setting?
- Are you allowing for more time when cooking more food at one time?

If the display shows a time counting down but the oven is not cooking:

- Is the Minute Timer in use?
- Is the oven door closed completely?
- Is the oven in standing time between QUICK DEFROST and COOK or AUTO SET TIME? (See page 15.)

If you do not hear a Programming Tone (page 6):

- Is the command correct?
- Has the tone been cancelled?

If the fan seems to be running slower than usual:

- Has the oven been stored in a cold area? The fan will run slower until the oven warms up to normal room temperature.

If there has been a power interruption, the Display will show 88:88. Reset the clock (page 9).

If the microwave oven turns off too soon or not soon enough when using the probe:

- Is at least $\frac{1}{3}$ of the probe in the food?
- Is the probe tip in the center of the food?
- Is the probe touching bone or fat?
- Have you allowed roasts to stand for a few minutes after cooking?
- Is the probe plugged tightly into its socket?
- Is Cook Power set correctly?
- Is the Probe Temperature set correctly?

2. If you need assistance*...

Call Whirlpool COOL-LINE® service assistance telephone number. Dial free from anywhere in the U.S.:

1-800-253-1301

and talk with one of our trained Consultants. The Consultants can instruct you in how to obtain satisfactory operation from your appliance or, if service is necessary, recommend a qualified service company in your area.

3. If you need service*...



Whirlpool has a nationwide network of franchised TECH-CARE® service Companies. TECH-CARE service technicians are trained to fulfill the product warranty and provide after-warranty

service, anywhere in the United States. To locate TECH-CARE service in your area, call our COOL-LINE service assistance telephone number (see Step 2) or look in your telephone directory Yellow Pages under:

**APPLIANCES - HOUSEHOLD -
MAJOR - SERVICE & REPAIR**

WHIRLPOOL APPLIANCES
FRANCHISED TECH-CARE SERVICE

SERVICE COMPANIES
XYZ SERVICE CO
123 MAPLE

999-9999

**ELECTRICAL APPLIANCES -
MAJOR - REPAIRING & PARTS**

WHIRLPOOL APPLIANCES
FRANCHISED TECH-CARE SERVICE

SERVICE COMPANIES
XYZ SERVICE CO
123 MAPLE

999-9999

OR

**WASHING MACHINES, DRYERS
& IRONERS - SERVICING**

WHIRLPOOL APPLIANCES
FRANCHISED TECH-CARE SERVICE

SERVICE COMPANIES
XYZ SERVICE CO
123 MAPLE

999-9999

4. If you have a problem*...

Call our COOL-LINE service assistance telephone number (see Step 2) and talk with one of our Consultants, or if you prefer, write to:

Mr. Robert Stanley
Division Vice President
Whirlpool Corporation
2000 M-63
Benton Harbor, MI 49022

*If you must call or write, please provide: model number, serial number, date of purchase, and a complete description of the problem. This information is needed in order to better respond to your request for assistance.

5. If you need FSP® replacement parts*...

FSP is a registered trademark of Whirlpool Corporation for quality parts. Look for this symbol of quality whenever you need a replacement part for your Whirlpool appliance. FSP replacement parts will fit right and work right, because they are made to the same exacting specifications used to build every new Whirlpool appliance.

To locate FSP replacement parts in your area, refer to Step 3 above or call the Whirlpool COOL-LINE service assistance number in Step 2.

*If you must call or write, please provide: model number, serial number, date of purchase, and a complete description of the problem. This information is needed in order to better respond to your request for assistance.

WHIRLPOOL® FULL SIZE COUNTERTOP MICROWAVE OVEN WARRANTY

LENGTH OF WARRANTY	WHIRLPOOL WILL PAY FOR
FULL ONE-YEAR WARRANTY From Date of Purchase	FSP® replacement parts and repair labor to correct defects in materials or workmanship. Service must be provided by a franchised TECH-CARE® service company
LIMITED FOUR-YEAR WARRANTY Second Through Fifth Year From Date of Purchase	FSP replacement parts for solid-state touch control system if defective in materials or workmanship. (Touch Control models only.)
LIMITED NINE-YEAR WARRANTY Second Through Tenth Year From Date of Purchase	FSP replacement magnetron tube if defective in materials or workmanship.
WHIRLPOOL WILL NOT PAY FOR	
<p>A. Service calls to:</p> <ol style="list-style-type: none"> 1. Correct the installation of the microwave product. 2. Instruct you how to use the microwave product. 3. Replace house fuses or correct house wiring. 4. Replace owner accessible light bulbs. <p>B. Repairs when microwave product is used in other than normal, single-family household use.</p> <p>C. Pick up and delivery. This product is designed to be repaired in the home.</p> <p>D. Damage to microwave product caused by accident, misuse, fire, flood, acts of God or use of products not approved by Whirlpool.</p> <p>E. Any labor costs during the limited warranties.</p>	

WHIRLPOOL CORPORATION SHALL NOT BE LIABLE FOR INCIDENTAL OR CONSEQUENTIAL DAMAGES. Some states do not allow the exclusion or limitation of incidental or consequential damages so this limitation or exclusion may not apply to you. This warranty gives you specific legal rights, and you may also have other rights which vary from state to state.

Outside the United States, a different warranty may apply. For details, please contact your franchised Whirlpool distributor or military exchange.



Part No. 3147054 Rev. A
©1987 Whirlpool Corporation

Printed in U.S.A.

Ice Makers, Dishwashers, Built-In Ovens and Surface Units, Ranges, Microwave Ovens, Trash Compactors, Room Air Conditioners, Dehumidifiers, Automatic Washers, Clothes Dryers, Freezers, Refrig

