

316255318

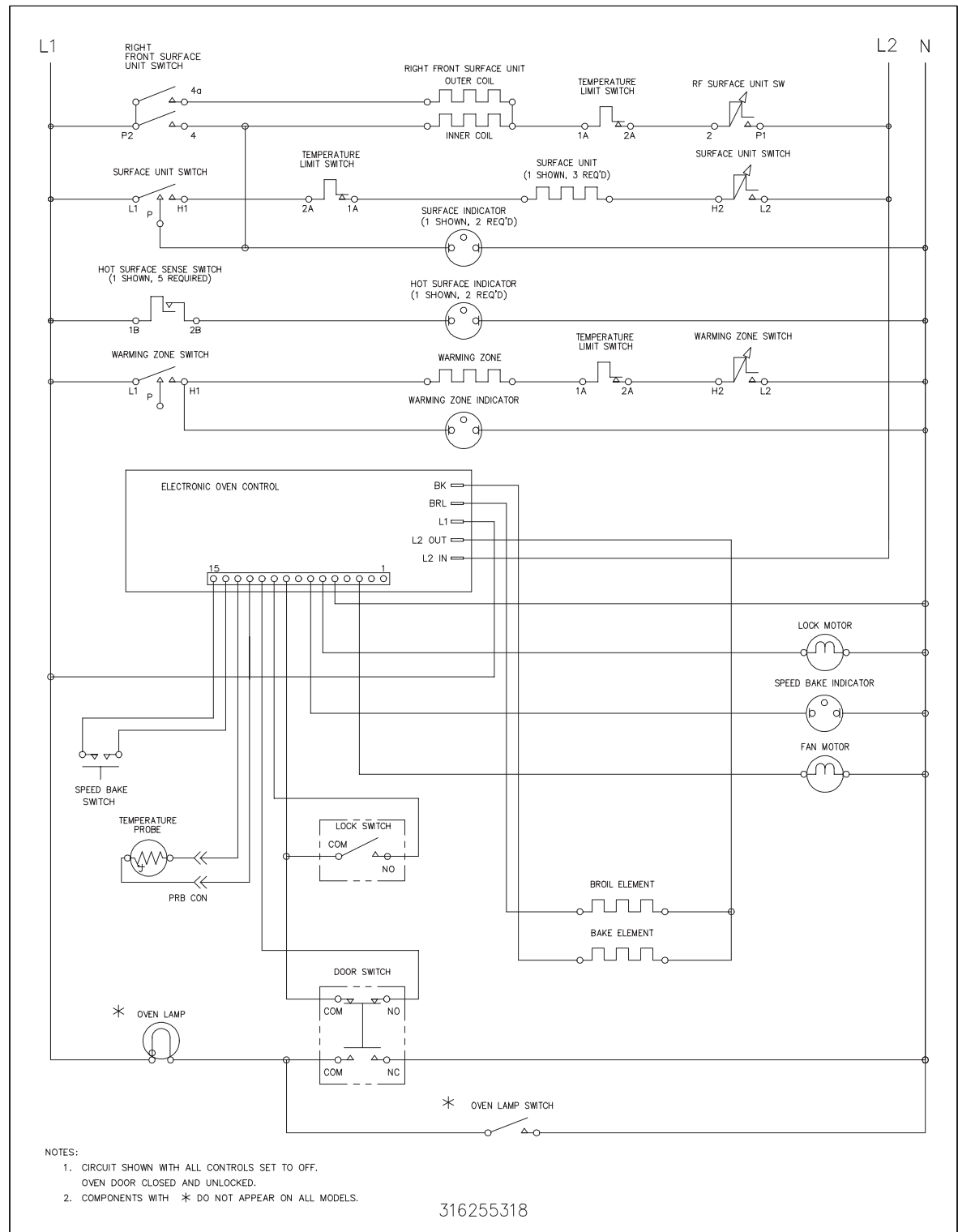

316255318