



Use & Care Guide



TimeSmart™

Visit our Website at:
www.WhirlpoolAppliances.com

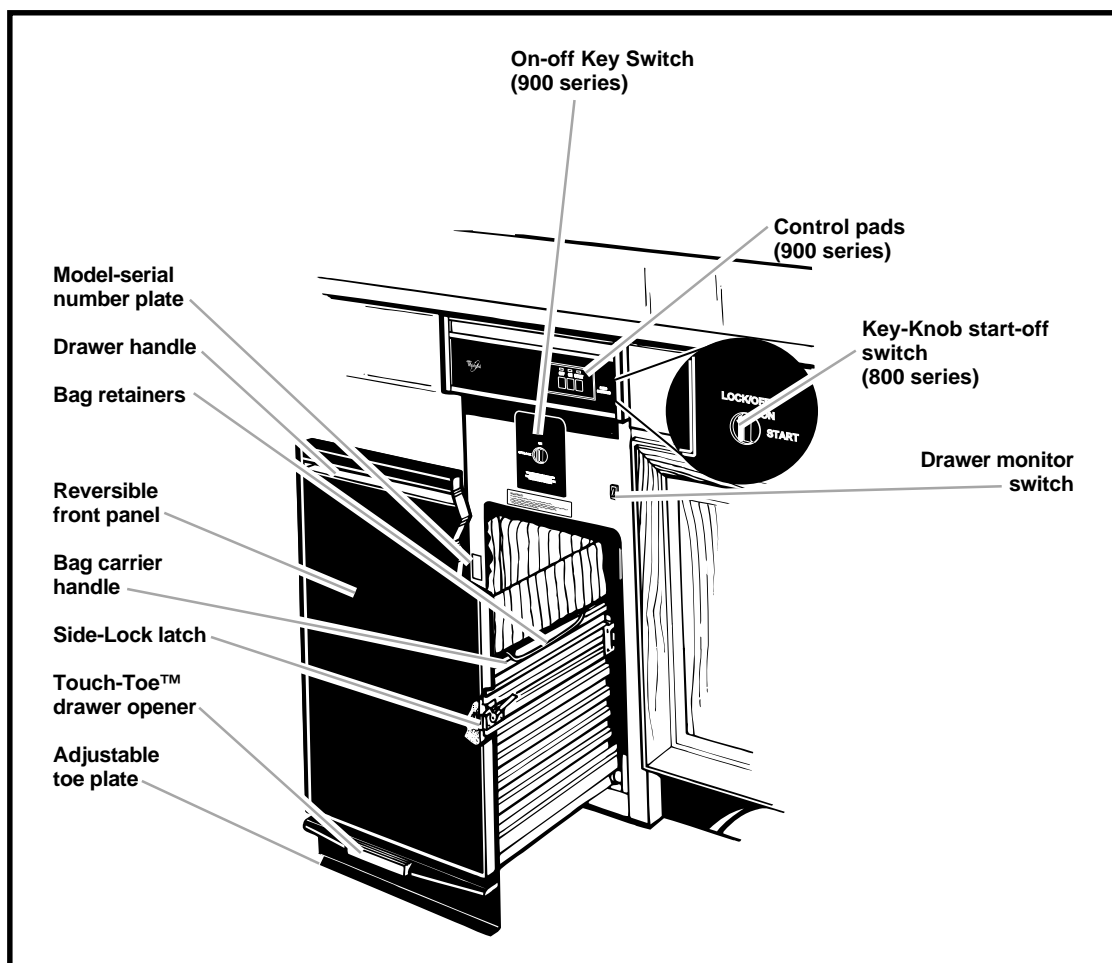

COMPACTORS MODEL SERIES 800,900

PART NO. 9871224 Rev. B

Contents

	Page
Compactor Safety	2
Important Safety Instructions	3
Help Us Help You	3
Grounding Instructions	4
Using Your Compactor	5
Removing a filled bag	7
Installing a new bag	9
How Your Compactor Works	11
Caring for Your Compactor	12
Changing Your Compactor's Color	14
If You Need Assistance or Service	15
Whirlpool Compactor Warranty	16

Thank you for buying a WHIRLPOOL® appliance. Please complete and mail the Owner Registration Card provided with this product. Then complete the form below. Have this information ready if you need service or call with a question.

- Copy model and serial numbers from plate (see diagram on front cover) and purchase date from sales slip.
- Keep this book and sales slip together in a handy place.

Model Number

Serial Number

Purchase Date

Service Company Phone Number

Your safety and the safety of others is very important.

We have provided many important safety messages in this manual and on your appliance. Always read and obey all safety messages.



This is the safety alert symbol.

This symbol alerts you to hazards that can kill or hurt you and others.

All safety messages will be preceded by the safety alert symbol and the word "DANGER" or "WARNING." These words mean:

⚠ DANGER

You will be killed or seriously injured if you don't follow instructions.

⚠ WARNING

You can be killed or seriously injured if you don't follow instructions.

All safety messages will identify the hazard, tell you how to reduce the chance of injury, and tell you what can happen if the instructions are not followed.

Important Safety Instructions

WARNING: When using an electrical appliance, basic precautions should always be followed, including the following:

- Read all instructions before using the compactor.
- Close supervision is necessary when used by or near children. Do not allow to be used as a toy, or to run unattended at any time. Lock Key Switch when not in use and store key out of reach of children.
- Do not touch moving parts.
- Do not operate with a damaged cord set, plug, motor, or after damage in any manner. Have the compactor examined, repaired or adjusted by an authorized serviceperson.
- Do not compact toxic or volatile flammable material such as oily rags and insect sprays. Do not compact lighted cigarettes, cigars, or other hot or burning items. Do not overload the compactor.
- Do not take apart the compactor. Incorrect reassembly can cause electric shock when subsequently used.
- Use only for intended use as described in this manual. Do not use other than manufacturer's recommended attachments.
- Handle a loaded trash bag with care. Sharp objects can pierce the bag and cause injury. Do not overload trash bag with heavy material such as glass.

— SAVE THESE INSTRUCTIONS —

Help Us Help You

- The compactor is designed for household use only.
- Do not install or store compactor where it will be exposed to the weather.
- Do not use a freestanding compactor as a counter for electrical cooking appliances or as a cutting board.
- You are responsible for making sure that your compactor:
 - Is used only for jobs normally expected of home compactors.
 - Is properly installed and leveled on a floor that can support its weight.
- Do not set hot pans, etc., on a freestanding compactor top. Do not spill any liquids on a freestanding compactor top.

⚠ WARNING



Electrical Shock Hazard
Plug into a grounded 3 prong outlet.
Do not remove ground prong.
Do not use an adapter.
Do not use an extension cord.
Failure to follow these instructions can result in death, fire, or electrical shock.

Grounding Instructions

The compactor is for use on a single phase, 115-volt, 60 Hz, AC only 15 or 20 ampere fused and properly grounded circuit and is equipped with a grounding plug as shown below. Time delay fuse or circuit breaker is recommended. It is recommended that a separate circuit serving only this appliance be provided. In the event of an electrical short circuit, grounding reduces the risk of electric shock by providing an escape wire for the electric current. Do not modify the plug attached to the compactor; use only with a grounded receptacle.

This compactor must be grounded while in use to reduce the risk of electric shock. The compactor is equipped with a three-conductor cord and three-prong grounding-type plug to fit the proper grounding-type receptacle. The green — or green and yellow — conductor in the cord is the grounding wire. Never connect the green — or green and yellow — wire to a live terminal. The outlet should be properly installed and grounded in accordance with the National Electrical Code and local codes and ordinances. No adapter should be used with this appliance.

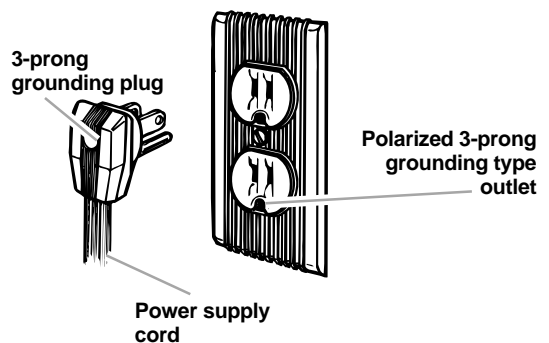

Using Your Compactor

The drawings in this book may vary slightly from your compactor model. They are designed to show the different features of all the models covered by this book.

NOTE: Your model may not include all the features shown.

⚠ WARNING



Explosion Hazard

Do not compact any container, aerosol cans, or cloths which might contain insecticide, hair spray, engine starting fluid, paints, liquids, thinners, or any other poisonous or explosive products.

Doing so can result in death, explosion, or fire.

⚠ WARNING



Cut Hazard

Do not push items down into compactor with hands or feet.

Doing so can result in cuts.

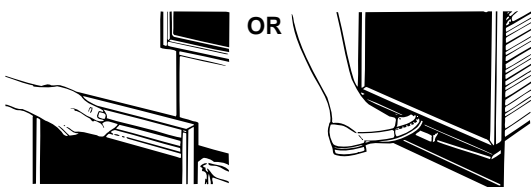

Open the drawer

Lift and pull the handle or press the Touch-Toe™ drawer opener to open the drawer.

Put in the trash

1. Wrap or cover wet or messy trash.
2. Load bottles or cans on their sides in the **center** of the drawer.
3. Do not compact items that may develop offensive odors such as raw meat, fish, grapefruit rinds, disposable diapers, or personal hygiene items.

Close the drawer

Push drawer in until it stops.

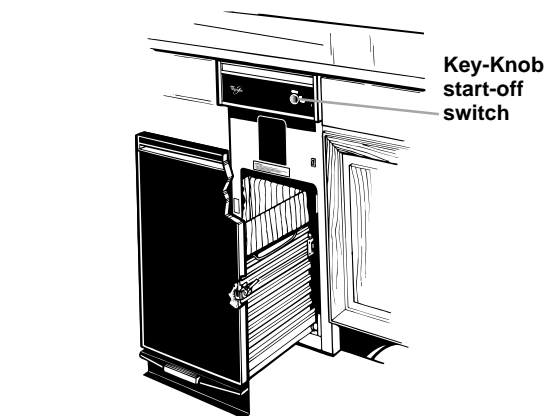

800 model series:

1. Turn the Key-Knob to **START**.
2. Let the Key-Knob go. The compactor will stop at the end of the cycle.



Using Your Compactor Continued

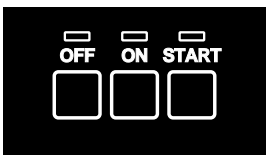
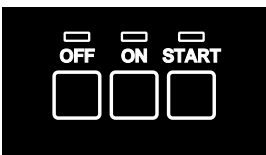
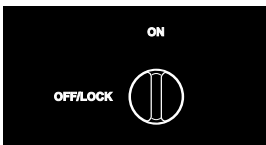
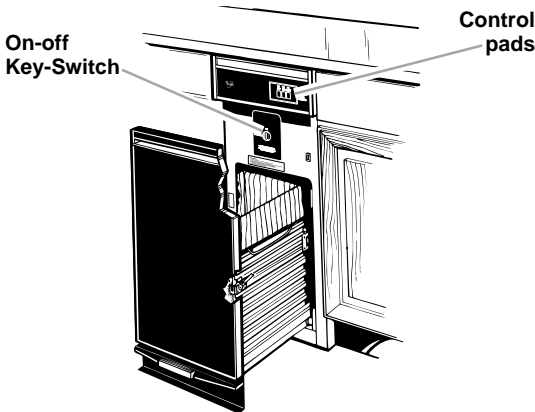

To stop the compactor during a cycle

1. Turn the Key-Knob to LOCK/OFF.
2. Turn the Key-Knob to ON. The compacting ram will rise.
3. When the ram stops rising, you can open the drawer.

To remove the Key-Knob

1. Turn the Key-Knob to the LOCK/OFF position.
2. Remove and store key in a safe place out of children's reach.

900 model series:

To start the compactor

1. Open the drawer. Turn the On-Off Key-Switch to ON.
2. Press the ON Control pad.
3. Press the START Control pad. The compactor will stop at the end of the cycle.

To stop the compactor during a cycle

1. Press the OFF Control pad.
2. Press the ON Control pad. The compacting ram will rise.
3. When the ram stops rising, you can open the drawer.

To remove the Key-Switch

1. Turn the Key-Switch to the OFF/LOCK position.
2. Remove and store key in a safe place out of children's reach.

Removing a filled bag

⚠ WARNING



Cut Hazard

**Do not touch sharp objects that have cut through the bag.
Doing so can result in cuts.**

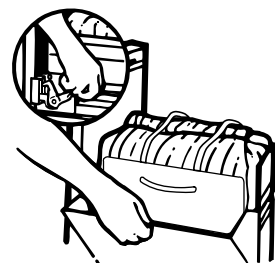
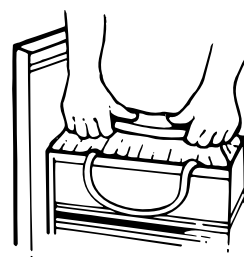
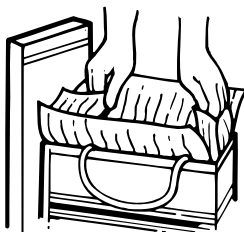

When the trash is compacted to the top of the drawer, remove the bag. If the bag is too heavy, compact less trash before emptying in the future.

If you are using paper compactor bags:

1. Pull the drawer completely open.
2. Pull all four bag cuffs up.
3. Tuck in slotted sides.
4. Bring top edges together and roll or fold to close bag.
5. Push Side-Lock Latch down and tilt drawer side open.

**Using Your Compactor
Continued**

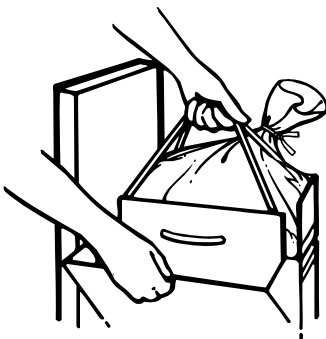
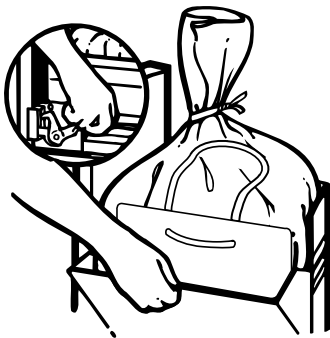
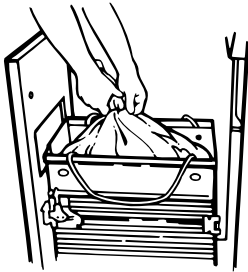
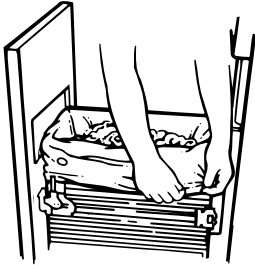
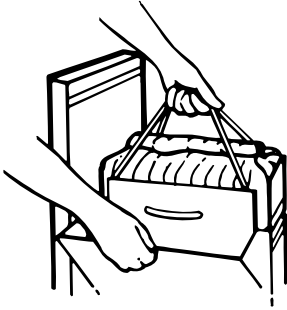

6. Lift bag by bag carrier handles.

If you are using plastic compactor bags:

1. Pull the drawer completely open.
2. Remove top of bag from bag retainer buttons.
Pull up all 4 bag cuffs.

3. Close bags with twist ties provided.

4. Push Side-Lock Latch down and tilt drawer side open.

5. Lift bag by bag carrier handles.

Installing a new bag

Before installing a new bag, be sure:

1. The drawer side is securely locked.
2. The container is clean and free of sharp debris that may have punctured the bag.

Do not use any kind of bag other than those designed especially for use in your compactor. Compactor bags may be purchased from your WHIRLPOOL Dealer or:

Whirlpool Corporation
 Attention: Customer Service Dept.
 1900 Whirlpool Drive
 LaPorte, IN 46350

You may also order approved compactor bags by calling our toll-free telephone number:
1-800-253-1301.

If you are using paper compactor bags:

1. Fit the bag caddy in the drawer.
2. Put unopened bag in drawer as shown. Spread front bag corners and slide cuff over right-front corner.
3. Spread rear bag corners and slide cuff over left rear corner.

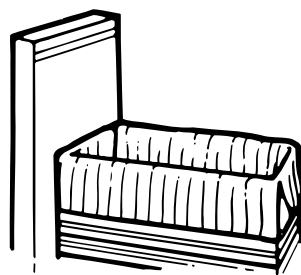
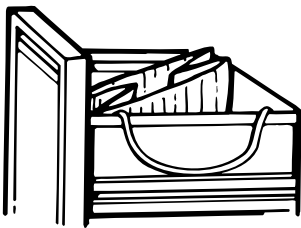
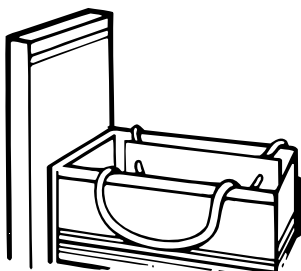

Using Your Compactor Continued

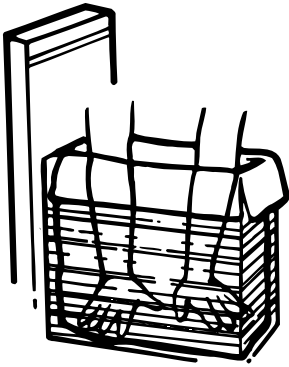

4. Press inside of bag against drawer bottom, sides and corners for a smooth fit.

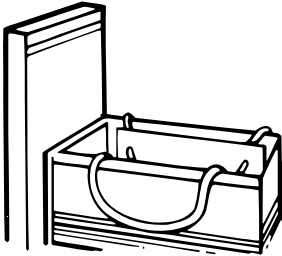

If you are using plastic compactor bags:

1. Fit the bag caddy in the drawer.

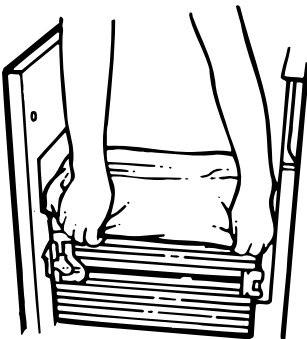

2. Place folded bag into the drawer. Open bag and pull top edges over the drawer top.
3. Lock bag in place by pulling the 4 prepunched holes over the bag retainer buttons. Holes will expand over the buttons without harming the bag.

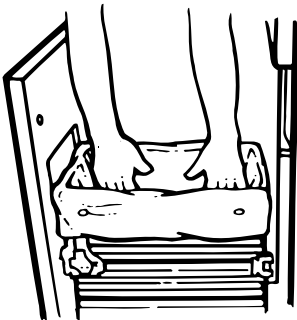

4. Press inside of bag against the drawer bottom, sides and corners for a smooth fit.

How Your Compactor Works

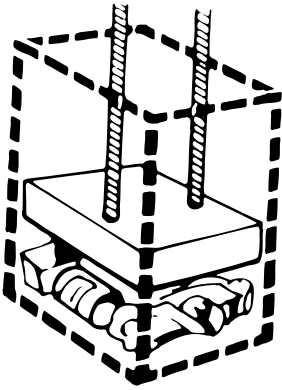

The compacting ram does not go to the drawer bottom. You will not see compacting of the first few loadings.

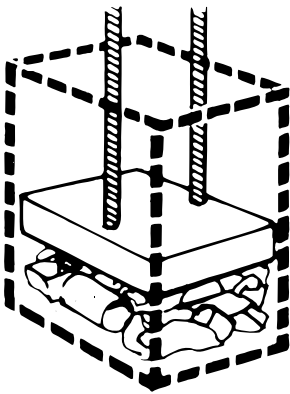

Compaction starts after the drawer is about $\frac{1}{3}$ full. You may hear a noise when glass breaks. **Strong glass bottles may not break at all.**

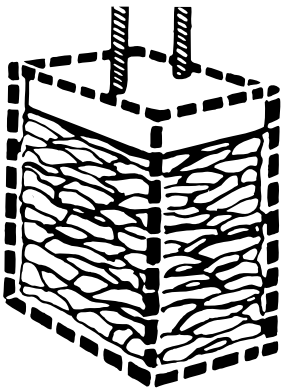

The trash in a full compactor bag will be about $\frac{1}{4}$ the size of its original bulk.

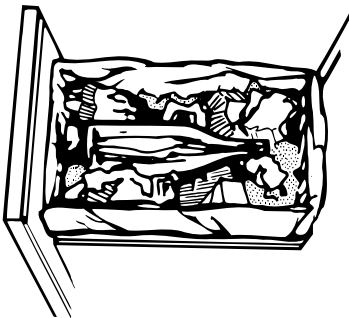

Load bulky trash, bottles, and cans in the **center** of the drawer. Bottles or cans not placed in the center may become caught between the ram and the drawer. The Drawer Monitor Switch senses a “misload” and causes the ram to return to the “up” position without compacting.

Caring for Your Compactor

⚠ WARNING



Cut Hazard

Wear heavy gloves when cleaning the inside of the compactor.

Failure to do so can result in cuts.

As is true of most appliances, proper care is needed to give you continued satisfaction. Before cleaning the compactor, turn the Key-Knob or Key-Switch to the OFF position and remove. If you will be away for more than a couple of days, remove the compactor bag. Lock the compactor and remove the Key-Knob or Key-Switch. Store the Key-Knob or Key-Switch in a safe place.

Clean exterior surfaces:

1. Wipe with warm, sudsy water and a damp cloth. Rinse. Dry with a soft cloth.
2. Wipe up spills right away. Some foods can damage the finish if left on the compactor surface.

Clean inside the drawer:

1. Remove the bag. (See "Removing a filled bag" section.)
2. Wear protective gloves. There may be bits of glass in the drawer.
3. Press Side-Lock Latch down.
4. Hold Side-Lock Latch and tilt side of drawer until the latch clears the drawer front.

NOTE: Drawer side can be removed by tilting it out, then lifting out.

5. Wash with a damp cloth using warm, sudsy water. Rinse. Dry with a soft cloth.
6. If drawer side was removed, slide it back into the tilted position.
7. Press the Side-Lock Latch down while pressing the side to the upright position.
8. Lock the Side-Lock Latch.

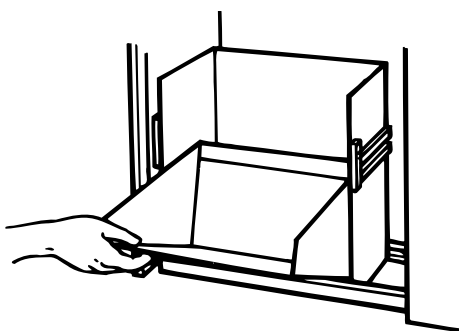
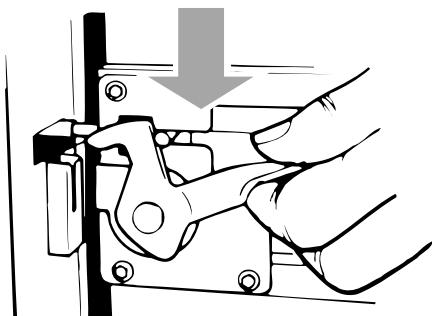

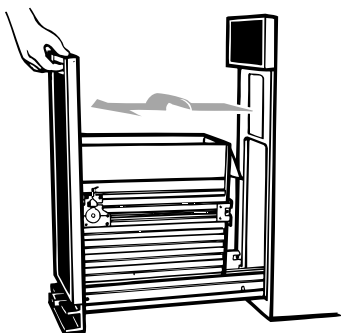

Clean inside the cabinet:

1. Wear protective gloves. There may be bits of glass in the cabinet.
2. Pull the drawer out until it stops.
3. Note the tracks in which the drawer rollers move.

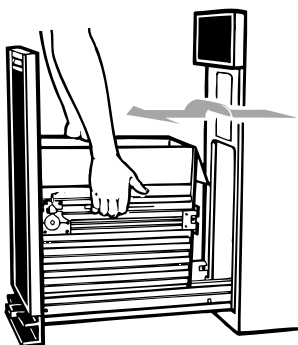

4. Lift the front to clear the drawer stops.
5. Grasp the drawer on the sides.
6. Pull it out the rest of the way.
7. Set it down gently.

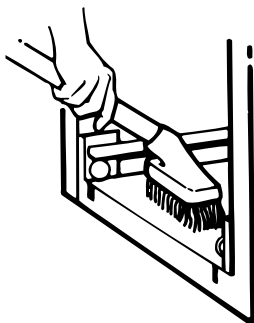

8. Vacuum inside of cabinet. Liquid spills or wet trash should be cleaned up by hand, or use a vacuum designed to pick up liquids.
9. Wash, rinse and dry inside.
10. Replace drawer.

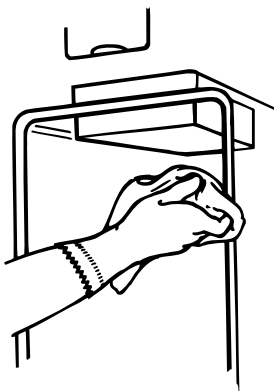

Wipe off the rim cover:

1. Wear protective gloves. There may be bits of glass on the rim cover.
2. Wipe glass particles off rim cover with a cloth or paper towels.
3. Use warm, sudsy water to remove foods. Rinse. Dry with a soft cloth.

Changing Your Compactor's Color

The color panel on the front of your compactor's drawer reverses to another color. You may also be able to order an extra color panel, depending on the model you have. Contact your authorized Whirlpool dealer.

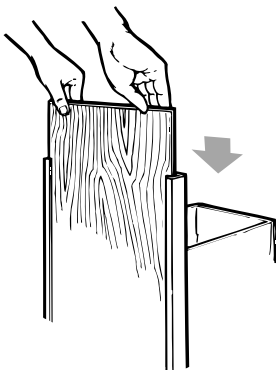
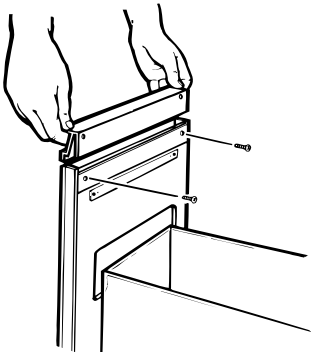
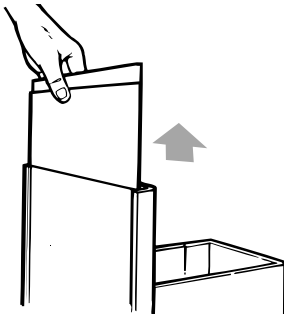
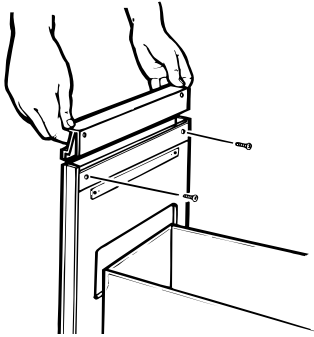

⚠ WARNING



Cut Hazard

Wear heavy gloves when handling panels. Failure to do so can result in cuts.

To change the color of your compactor's front panel, follow the directions below. All you need is a medium-sized screwdriver.

1. Slide drawer out.
2. Remove two screws shown.
3. Remove handle.
4. Remove the color panel and reverse. Be careful — edges may be sharp.

OR

Place extra panel at front with desired color showing.

5. Make sure panels are all the way down.
6. Be sure to replace cardboard spacer in its former position.
7. Replace handle and screws.
8. Slide drawer back in.

OPTION: Match your kitchen's color scheme by replacing color panel with your own creation (wallpaper, paneling). See Installation Instructions.

If You Need Assistance or Service

We suggest you follow these steps:

1. Before calling for assistance...

Performance problems often result from little things you can find and fix yourself without tools of any kind.

If your compactor won't operate:

- Is the power cord plugged into a live circuit with the proper voltage?
- Have you checked your home's main fuses or circuit breaker box?
- Is the drawer completely closed?
- Is the Key-Knob turned all the way to START before it is released (800 model series)?
- Is the Key-Switch turned to ON (900 model series)?
- Did you press the ON button before pressing the START button (900 model series)?

Drawer won't open:

- Drawer will open only when ram is all the way up.
- To raise the ram, turn the Key-Knob to START and release (800 model series).
- To raise the ram, press the OFF button, then press the ON button (900 model series).

If trash is not compacting:

- Is the drawer loaded properly? If anything gets between the ram and the drawer, the ram will return to the "up" position, without compacting.
- Drawer must be at least $\frac{1}{3}$ full before compactor will compact.

Not enough compaction or force:

- Compacting works best when only a few items are loaded. Use the compacting cycle frequently.

Bottles don't break:

- Not all bottles will break every time, depending on the bottle and the trash load below it.

2. If you need assistance*...

Call the Whirlpool Consumer Assistance Center telephone number. Dial toll-free from anywhere in the U.S.A.:



1-800-253-1301

and talk with one of our trained consultants. The consultant can instruct you in how to obtain satisfactory operation from your

appliance or, if service is necessary, recommend a qualified service company in your area.

If you prefer, write to:

Whirlpool Brand Home Appliances
Consumer Assistance Center
c/o Correspondence Dept.
Whirlpool Corporation
2000 North M-63
Benton Harbor, MI 49022-2692

Please include a daytime phone number in your correspondence.

3. If you need service*...

Whirlpool has a nationwide network of authorized service companies. Whirlpool service technicians are trained to fulfill the product warranty and provide after-warranty service, anywhere in the United States. To locate the authorized Whirlpool service company in your area, call our Consumer Assistance Center telephone number (see Step 2) or look in your telephone directory Yellow Pages under:



• APPLIANCE-HOUSEHOLD-MAJOR, SERVICE & REPAIR

- See: Whirlpool Appliances or Authorized Whirlpool Service
(Example: XYZ Service Co.)

• WASHING MACHINES & DRYERS, SERVICE & REPAIR

- See: Whirlpool Appliances or Authorized Whirlpool Service
(Example: XYZ Service Co.)

4. If you need FSP® replacement parts...

FSP is a registered trademark of Whirlpool Corporation for quality parts. Look for this symbol of quality whenever you need a replacement part for your WHIRLPOOL® appliance. FSP replacement parts will fit right and work right, because they are made to the same exacting specifications used to build every new WHIRLPOOL appliance.

To locate FSP replacement parts in your area, refer to Step 3 or call the Whirlpool Consumer Assistance Center number in Step 2.

*When asking for help or service:

Please provide a detailed description of the problem, your appliance's complete model and serial numbers, and the purchase date. (See page 2.) This information will help us respond properly to your request.

WHIRLPOOL®

Compactor Warranty

LENGTH OF WARRANTY	WHIRLPOOL WILL PAY FOR
FULL ONE-YEAR WARRANTY FROM DATE OF PURCHASE	FSP® replacement parts and repair labor to correct defects in materials or workmanship. Service must be provided by an authorized Whirlpool service company.
WHIRLPOOL WILL NOT PAY FOR	
<p>A. Service calls to:</p> <ol style="list-style-type: none"> 1. Correct the installation of your compactor. 2. Instruct you how to use your compactor. 3. Replace house fuses or correct house wiring. <p>B. Repairs when your compactor is used in other than normal, single-family household use.</p> <p>C. Pick up and delivery. This product is designed to be repaired in the home.</p> <p>D. Damage to your compactor caused by accident, misuse, fire, flood, acts of God, or use of products not approved by Whirlpool.</p> <p>E. Repairs to parts or systems caused by unauthorized modifications made to the appliance. 7/97</p>	

WHIRLPOOL CORPORATION SHALL NOT BE LIABLE FOR INCIDENTAL OR CONSEQUENTIAL DAMAGES. Some states do not allow the exclusion or limitation of incidental or consequential damages so this exclusion or limitation may not apply to you. This warranty gives you specific legal rights, and you may also have other rights which vary from state to state.

Outside the United States, a different warranty may apply. For details, please contact your authorized Whirlpool dealer.

If you need service, first see the "If You Need Assistance or Service" section of this book. After checking "If You Need Assistance or Service," additional help can be found by calling our Consumer Assistance Center telephone number, **1-800-253-1301**, from anywhere in the U.S.A.