

use & care guide

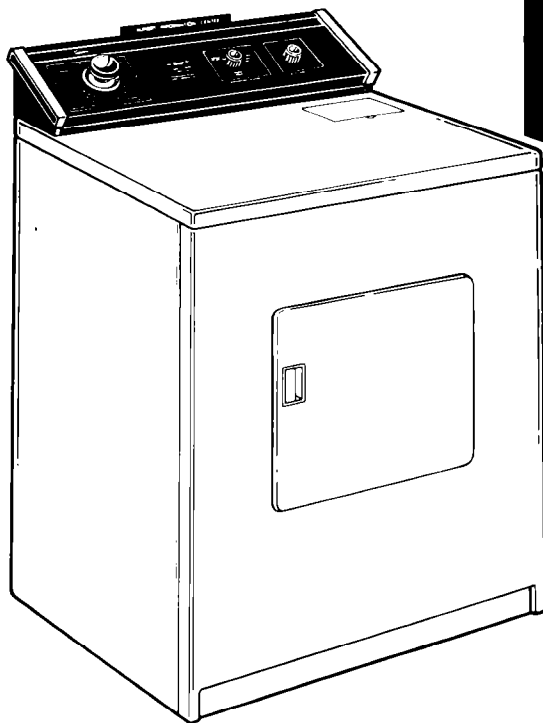



Whirlpool

AUTOMATIC DRYERS

**Electric Model
LE5530XP
and
Gas Model
LG5531XP**

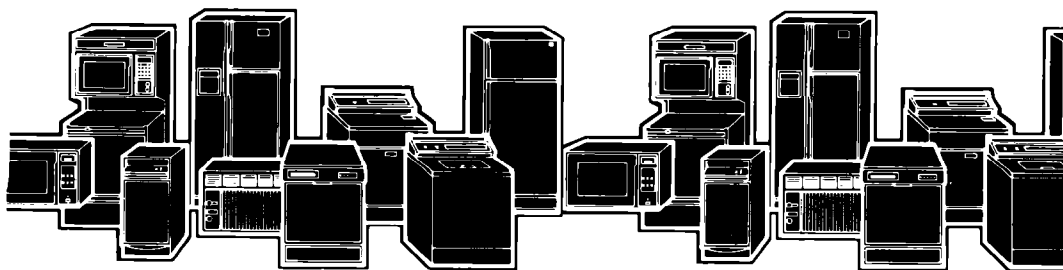
Wave Ovens, Trash Compactors, Room Air Conditioners, Dehumidifiers, Automatic Washers, Clothes Dryers, Freezers, Refrigerator-Freezer



Parts and features

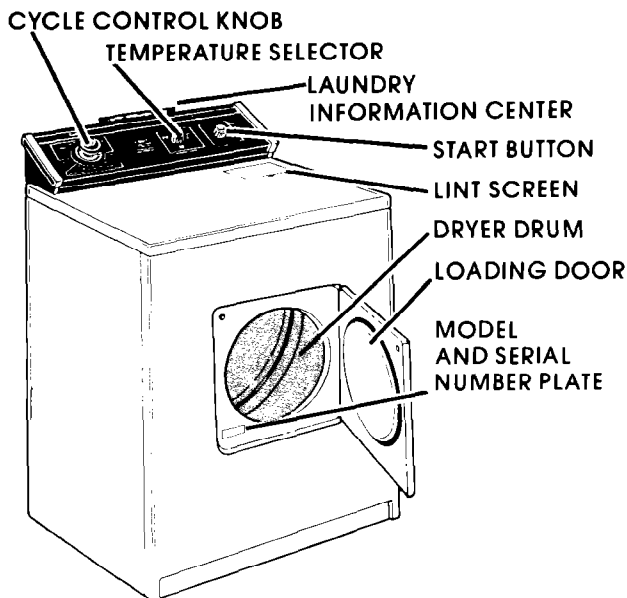

Remove the Consumer Buy Guide label before using your dryer. It will be easier to remove.

Wipe out the dryer drum with a damp cloth to remove dust from storing or shipping.

Copy your Model and Serial Numbers here

When you need service or call with a question, have this information ready:

- 1. Complete** Model and Serial Numbers (from the plate located as shown).
- 2.** Purchase date from sales slip.

Copy this information in these spaces. Keep this book, your warranty, sales slip and "Dryer Guide" in the Laundry Information Center on the back of the dryer console.

There is no warranty registration to return. Proof-of-purchase is all that is required for in-warranty service.

Complete Model Number

Complete Serial Number

Purchase Date

Service Company and
Telephone Number

Contents

	Page		Page
PARTS AND FEATURES	2	Drying Times	7
YOUR RESPONSIBILITIES	3	LINT SCREEN	8
SAFETY FIRST	3	LINT REMOVAL	8
SELECTING A CYCLE AND		CARING FOR YOUR DRYER . . .	9
STARTING YOUR DRYER	4	Vacation Care	9
OPERATING INSTRUCTIONS ..	6	IF YOU NEED SERVICE OR	
Dryer Cycles and Settings ..	6	ASSISTANCE	10
Cool Down Times	6	1. Before Calling for	
DRYING TIPS	7	Assistance	10
FLUFF AIR Setting	7	2. If You Need Assistance . . .	11
TUMBLE PRESS® Setting	7	3. If You Need Service	11
Mixed Loads	7	4. If You Have a Problem . . .	11

Your Responsibilities

Read this "Use and Care Guide" and your "Dryer Guide" carefully for important use and safety information.

You are personally responsible for making sure that your dryer...

- is installed by a qualified installer.
- is properly maintained.
- is installed in an area protected from the weather.
- is properly installed and leveled in a well ventilated room* on a floor that can support the weight.

- is located in an area where the temperature is above 45°F (7.2°C).
 - is connected to the right kind of outlet, electric supply and grounding.*
 - is properly connected to fuel and exhaust systems.*
 - is used only for jobs normally expected of home clothes dryers.
 - is not run where there may be explosive fumes.
 - is not used by children or anyone unable to operate it properly.
- *See the "Installation Instructions" for complete information.

Safety first

ALWAYS unplug the power supply cord or turn off electrical power before attempting to service the dryer. **Shut off the GAS VALVE** if yours is a gas dryer.

ALWAYS shut off the gas valve before leaving on vacation.

NEVER use flammable fluids (dry-cleaning solvents, gasoline, kerosene) in or near your dryer.

ALWAYS hand launder or air dry fabrics treated with flammable fluids before putting them into your dryer.

NEVER dry items containing wax or paint in the dryer. The fumes can create a **FIRE HAZARD**.

FIRE HAZARD and **DAMAGE** to some materials can result from:

- drying heat-sensitive materials with heat (see page 4).
- operating the dryer with the lint screen loose, damaged or missing.
- allowing lint to build up inside the dryer (see page 8).

NEVER allow children to operate, play with, or crawl inside the dryer.

NEVER operate the dryer if...

- it is not working right.
- it is damaged.
- parts are missing.
- all panels are not in place.

DO NOT let dust, lint, paper, rags, chemicals, etc., pile up around or under the dryer. **DO NOT** install against drapes or curtains.

• FOR YOUR SAFETY •

IF YOU SMELL GAS:

1. OPEN WINDOWS.
2. DON'T TOUCH ELECTRICAL SWITCHES.
3. EXTINGUISH ANY OPEN FLAME.
4. IMMEDIATELY CALL YOUR GAS SUPPLIER.

• FOR YOUR SAFETY •

DO NOT STORE OR USE GASOLINE OR OTHER FLAMMABLE VAPORS AND LIQUIDS IN THE VICINITY OF THIS OR ANY OTHER APPLIANCE.

• SAVE THESE INSTRUCTIONS •

Selecting a cycle and starting your dryer

Before starting your dryer, be sure laundry is sorted and loaded properly (see your "Dryer Guide"). **Be sure the door is tightly closed.**

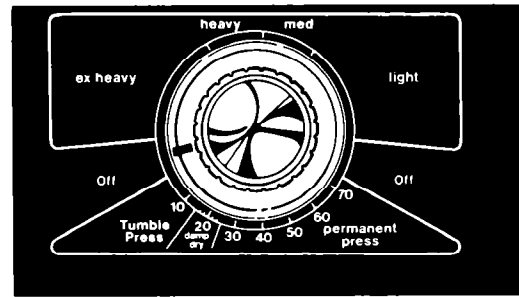

TYPE OF LOAD	SUGGESTED CYCLE	SUGGESTED TEMPERATURE
COTTONS – LINENS		
EXTRA HEAVY – Bedspreads, mattress pads, quilts	EX HEAVY	
HEAVYWEIGHT FABRICS – Towels, jeans, corduroys, work clothes	HEAVY	PERM'T PRESS
MEDIUMWEIGHT COTTONS – Sheets, pillowcases, cotton underwear, diapers	MEDIUM	HEAVY HIGH
LIGHTWEIGHT COTTONS – Batistes, organdies, lingerie	LIGHT	
PERMANENT PRESS, SYNTHETICS AND BLENDS		
HEAVYWEIGHT FABRICS – Work clothes, jackets, raincoats	40-50 MINS.	PERM'T PRESS
MEDIUMWEIGHT FABRICS – Shirts, play clothes, sheets, slacks	30-40 MINS.	HEAVY HIGH
LIGHTWEIGHT FABRICS – Lingerie, blouses, dresses	20-30 MINS.	
KNITS		
HEAVYWEIGHT – Cottons, rayons, blends, T-shirts, slacks, shirts	40-50 MINS.	PERM'T PRESS
LIGHTWEIGHT – Synthetics (polyester, acrylic, etc.) and blends, lingerie, blouses, dresses	30-40 MINS.	HEAVY HIGH
LIGHTWEIGHT AND DELICATE FABRICS		
Sheer Curtains (2 or 3 panels)	20-30 MINS.	KNITS GENTLE
Gauze, lace, etc.	15-20 MINS.	LOW
RUBBER, PLASTIC, HEAT-SENSITIVE FABRICS		
FOAM RUBBER – Pillows, bras, stuffed toys	20-30 MINS.	FLUFF AIR
PLASTIC – Shower curtains, tablecloths	20-30 MINS.	
RUBBER-BACKED RUGS	40-50 MINS.	
OLEFIN, POLYPROPYLENE, SHEER NYLON ..	15-20 MINS.	

WARNING: Drying these and other heat-sensitive materials with heat can damage them or be a FIRE HAZARD.

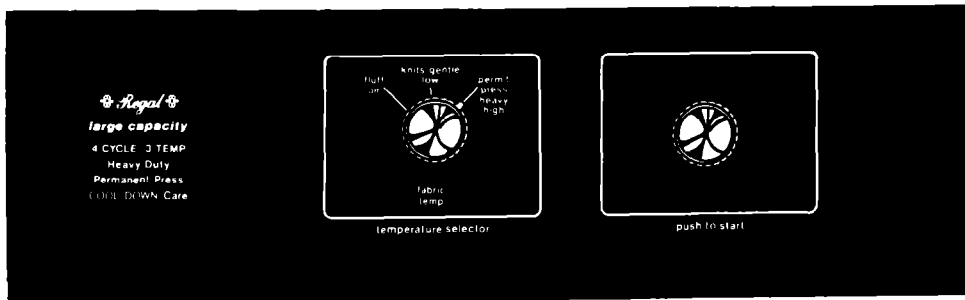

Select a 1. CYCLE

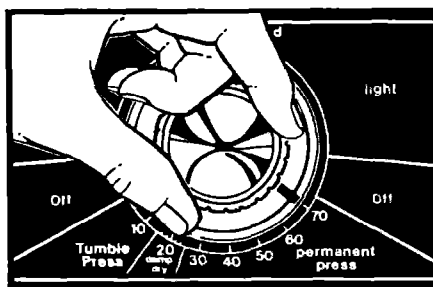

Turn the Control Knob either way to point to the cycle and setting you want. See page 6 for information on the cycles.

Push the 3. START Button

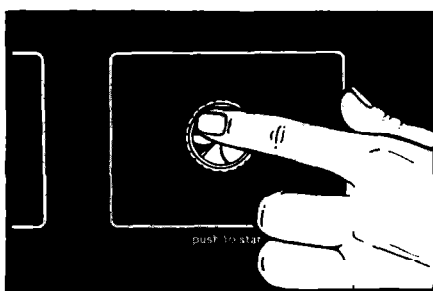

The dryer will start tumbling when you push the START Button.

Set TEMPERATURE 2. SELECTOR

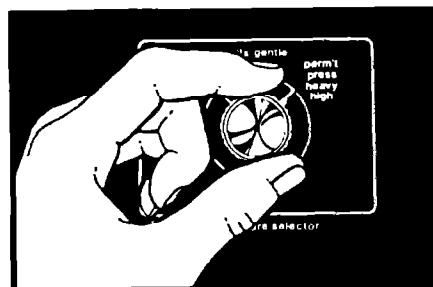

Turn the Temperature Selector to the needed drying temperature.

To stop and restart the dryer

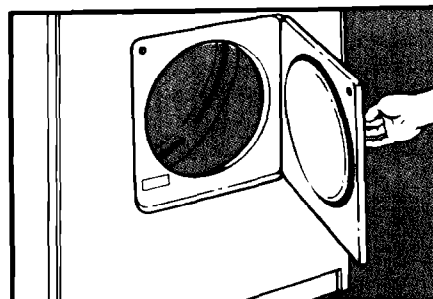

To stop the dryer, open the door (or turn the Control Knob to OFF).
To restart the dryer, close the door, select cycle, if necessary, and push START.

The Cycle Control Knob should point to OFF when the dryer is not in use.

Operating instructions

Dryer cycles and settings

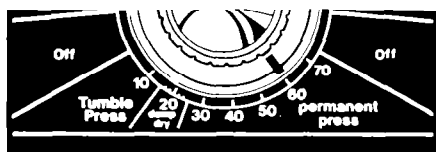

The PERMANENT PRESS Cycle helps provide the special care that permanent press and synthetic fabrics need...a period of heated drying followed by a 10 minute cool down. The chart on page 4 suggests time and temperature settings for different kinds of loads.



The **EX HEAVY, HEAVY, MEDIUM** and **LIGHT** cycles describe the loads they are designed to dry. The chart on page 4 tells what is meant by EX HEAVY, HEAVY, MEDIUM and LIGHT loads.

At each setting, the dryer will run about long enough to dry the load described by the setting. Example:

The **HEAVY** Cycle is designed to be long enough to dry a load of heavy fabrics (towels, jeans, corduroys, etc.) when the Temperature Selector is set on PERM'T PRESS/HEAVY HIGH.

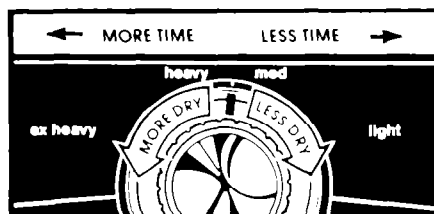

If the load is not as dry as you want, set the dial more to the **left** the next time you dry that kind of load.

If the load is dryer than you want, set the dial more to the **right** the next time you dry that kind of load.

Cool down times

In all cycles, the heat shuts off before the dryer stops tumbling. This cool down time helps:

- keep wrinkles from setting in.
- make handling the hot load items easier.

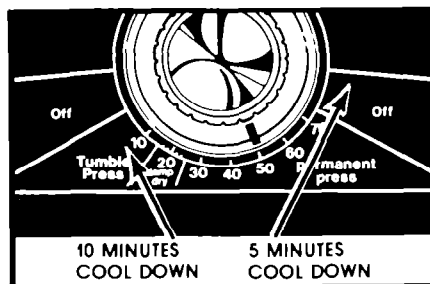

The PERMANENT PRESS Cycle has 10 minutes of cool down time at the end of the cycle.

All other cycles have 5 minutes of cool down time.

Overdrying can cause shrinkage, static cling and damage to some fabrics.

To help reduce wrinkling, take the load from the dryer as soon as tumbling stops. This is very important for permanent press, knits and synthetic fabrics.

Drying tips

FLUFF AIR

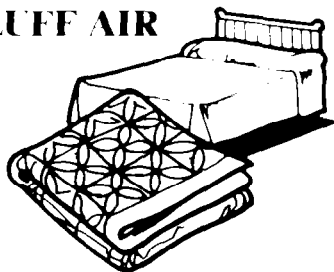

The dryer does not heat when the Temperature Selector is set on FLUFF AIR. This setting can be used to fluff bedding, plastic tablecloths, foam rubber pillows, stuffed toys, sneakers, etc.



WARNING: Drying plastic or rubber items with heat may damage the items or be a FIRE HAZARD.

1. Turn the Temperature Selector to FLUFF AIR.
2. Turn the Control Knob to the number of minutes you want in the PERMANENT PRESS Cycle.
3. Push the START Button.

Mixed loads

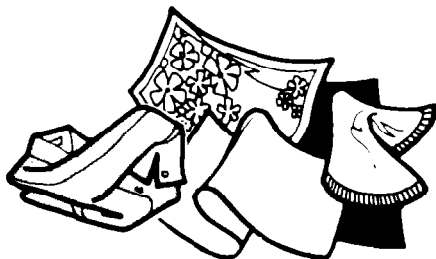

When drying a load with different kinds and weights of fabrics, use the cycle suggested for the lightest fabrics. When the dryer stops, remove dry items and reset the control.

TUMBLE PRESS® Setting

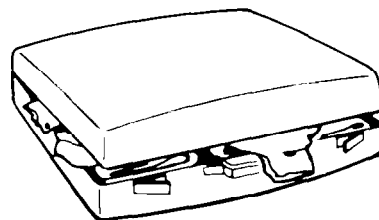

The TUMBLE PRESS setting removes wrinkles from dry clothing such as items that may have been packed in a suitcase, closet, or items not removed from the dryer.

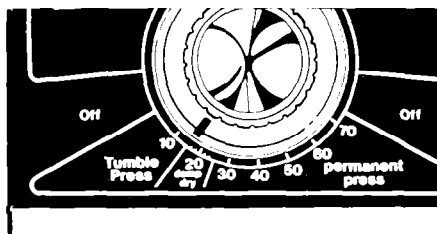

1. Set Temperature Selector to PERMIT PRESS / HEAVY HIGH.
2. Set Control Knob to TUMBLE PRESS.
3. Push START Button.

The load will tumble in heated air for 5 minutes. The heat shuts off and the dryer continues to tumble the load for 10 more minutes.

For best results, TUMBLE PRESS only a few items at a time. Put them on hangers or fold them as soon as the dryer stops.

Drying times

Drying times will vary depending on:

- amount of moisture in the clothes.
- type and weight of the fabric.
- size of the load.
- room temperature around the dryer.
- temperature of the wash/rinse water.
- amount of lint in the lint screen.
- dryer temperature selection.

See page 6 in your "Dryer Guide" for more information.

Lint screen

Clean the lint screen before each load. A screen blocked by lint can increase drying time and may be a FIRE HAZARD.

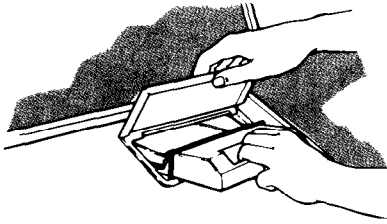

Open the lid and pull the lint screen straight out.

WARNING: DO NOT run the dryer with the lint screen loose, damaged or missing. Doing so can cause overheating, can damage fabrics and can be a **FIRE HAZARD**.

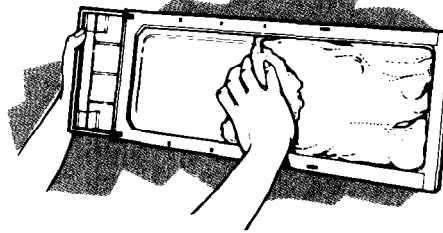

ROLL the lint off the screen with your fingers.

DO NOT rinse or wash the screen.

Push the screen firmly back into place.

Lint removal

Lint can gather inside the dryer and create a fire hazard. **This lint should be removed every 2 to 3 years, or more often, depending on dryer usage.**

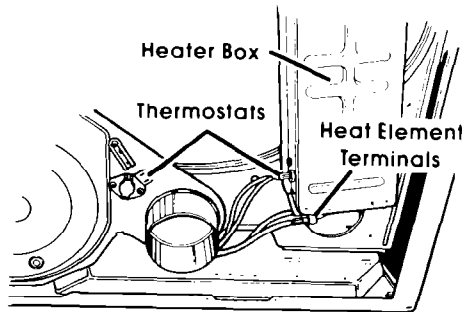

ELECTRIC DRYERS

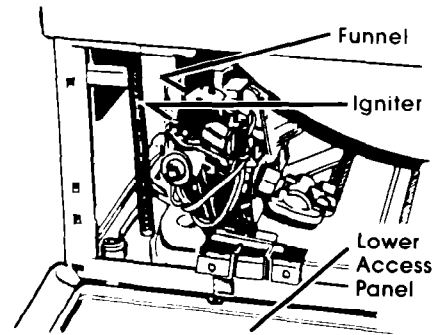

GAS DRYERS

Cleaning should be done only by a qualified person.



- Avoid electrical shock hazard – unplug power supply cord or turn off electrical power.
- Avoid injury or damage – do not put hands inside cabinet.
- Make sure dryer is cool.

1. Remove back panel (electric) or lower access panel (gas).
2. Avoid damaging wires, thermostats, funnel or igniter.
3. Remove lint from shaded area – see art – with a soft brush or vacuum cleaner.
4. Replace panel; reconnect and re-level dryer.

Caring for your dryer



Remove sharp objects from clothing before drying – pins, buckles, etc. **Close metal zippers.**

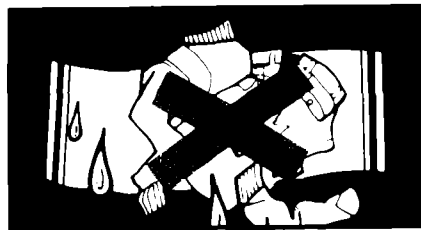

Never leave wet or damp laundry in your dryer.



Wipe off all spills with a damp, soft cloth. Spills allowed to remain may dull or damage the finish.

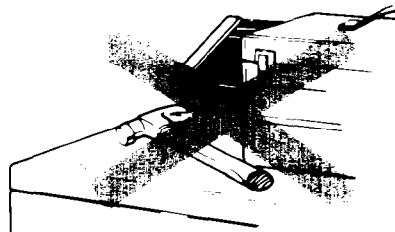

Sharp or heavy objects should never be put on or in the dryer. Check pockets for bolts, nuts, etc.

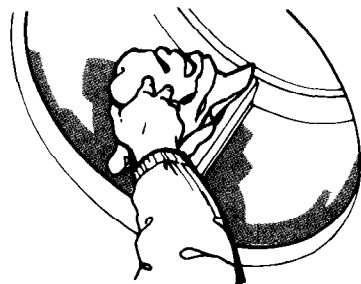

Non-colorfast items can stain the drum. Wipe **carefully** after drying to make sure there is no dye to be transferred to items in the next load.

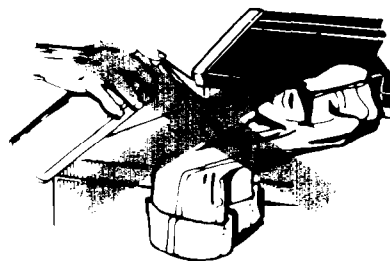

Some pretreatment products can damage dials, console and finish. Do not use these products on or near your dryer.

Vacation care

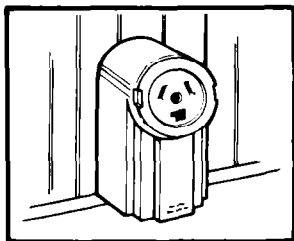

Unplug power cord or turn off electrical power.

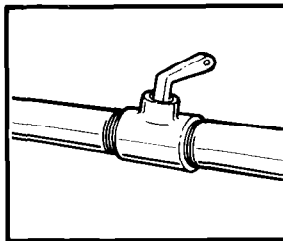

For gas dryers, close gas valve.

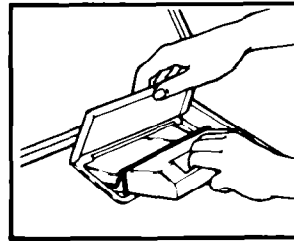

Clean lint screen.

If you need service or assistance, we suggest you follow these four steps:

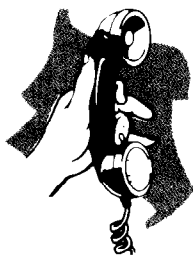

1. Before calling for assistance...

Performance problems often result from little things you can find and fix yourself without tools of any kind.

DRYER DOES NOT RUN:

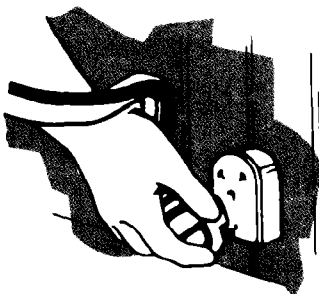

- Is power supply cord plugged in?
- Is door closed tightly?
- Did you push START Button?

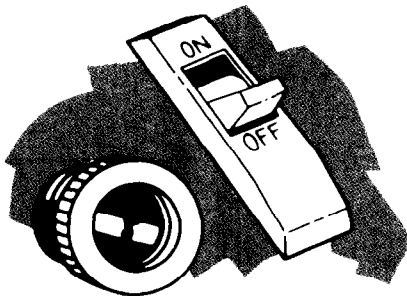

- Are fuses blown or a circuit-breaker tripped?

DRYER DOES NOT HEAT:

- The AIR setting is without heat.
- The last minutes of heat settings are without heat.

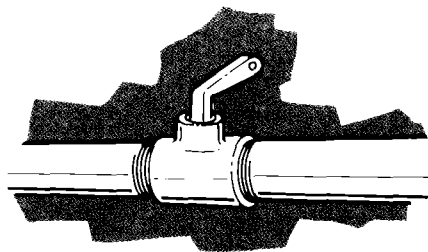

- Is gas turned on? If not, turn Control Knob to OFF. Turn on gas. Wait 5 minutes. Reset controls and start.
- An electric dryer uses a circuit breaker or 2 fuses. If one fuse is blown, the dryer may run, but not heat.

DRYING TIME SEEMS LONG:

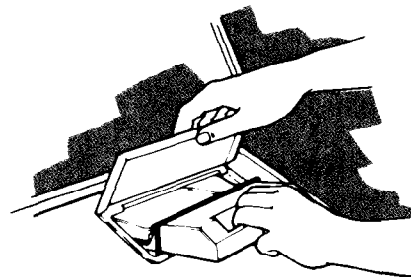

- Is the lint screen clean?
- See page 6 in your "Dryer Guide."

2. If you need assistance*...

Call Whirlpool COOL-LINE® service assistance telephone number. Dial free from:

Continental U.S. . . (800) 253-1301
 Michigan (800) 632-2243
 Alaska & Hawaii (800) 253-1121

and talk with one of our trained Consultants. The Consultant can instruct you in how to obtain satisfactory operation from your appliance or, if service is necessary, recommend a qualified service company in your area.

3. If you need service*...



Whirlpool has a nationwide network of franchised TECH-CARE® Service Companies. TECH-CARE service technicians are trained to fulfill the product warranty and provide after-warranty service, anywhere in the United States. To locate TECH-CARE service in your area, call our COOL-LINE service assistance telephone number (see Step 2) or look in your telephone directory Yellow Pages under:

APPLIANCES HOUSEHOLD MAJOR SERVICE & REPAIR	OR	ELECTRICAL APPLIANCES MAJOR REPAIRING & PARTS
WHIRLPOOL APPLIANCES FRANCHISED TECH CARE SERVICE		WHIRLPOOL APPLIANCES FRANCHISED TECH CARE SERVICE
SERVICE COMPANIES		SERVICE COMPANIES
XYZ SERVICE CO 123 Maple 999 9999		XYZ SERVICE CO 123 Maple 999 9999
OR		
WASHING MACHINES DRYERS & IRONERS SERVICING		
WHIRLPOOL APPLIANCES FRANCHISED TECH CARE SERVICE		
SERVICE COMPANIES		
XYZ SERVICE CO 123 Maple 999 9999		

4. If you have a problem*...

Call our COOL-LINE service assistance telephone number (see Step 2) and talk with one of our Consultants, or if you prefer, write to:

Mr. Robert F. Gunts, Vice President
 Whirlpool Corporation
 Administrative Center
 2000 US-33 North
 Benton Harbor, MI 49022

*If you must call or write, please provide: model number, serial number, date of purchase, and a complete description of the problem. This information is needed in order to better respond to your request for assistance.



FSP is a registered trademark of Whirlpool Corporation for quality parts. Look for this symbol of quality whenever you need a replacement part for your Whirlpool appliance. FSP replacement parts will fit right and work right, because they are made to the same exacting specifications used to build every new Whirlpool appliance.

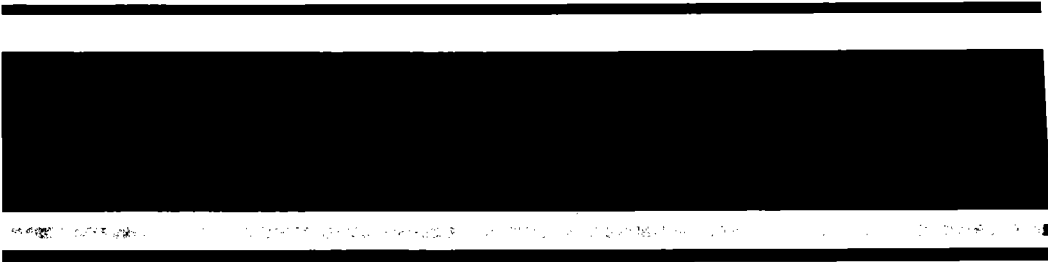

Making your world a little easier.

Part No. 693692
©1984 Whirlpool Corporation

Printed in U.S.A.

Automatic Washers, Clothes Dryers, Freezers, Refrigerator-Freezers, Ice Makers, Dishwashers, Built-In Ovens and Surface Units, Ranges, Micro

