

use & care guide

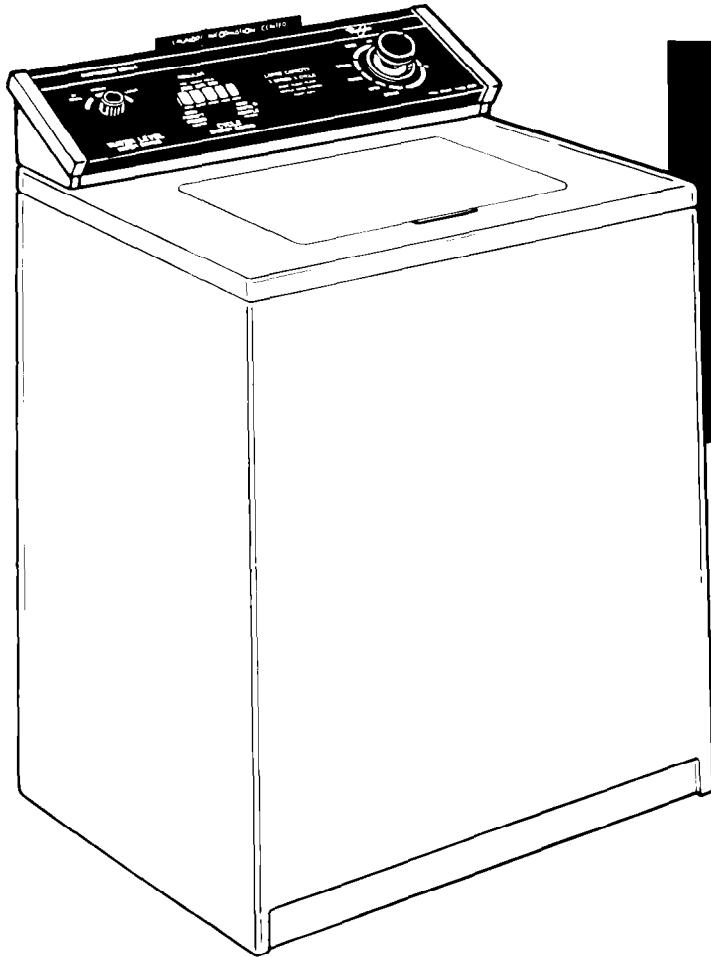

Customized Series

**AUTOMATIC
WASHER**

**Large Capacity
Model
LA6150XS**

Freezers, Refrigerator-Freezers, Ice Makers, Dishwashers, Built-In Ovens and Surface Units, Ranges, Microwave Ovens, Trash Compactors, Room Air Conditioners, Dehumidifiers

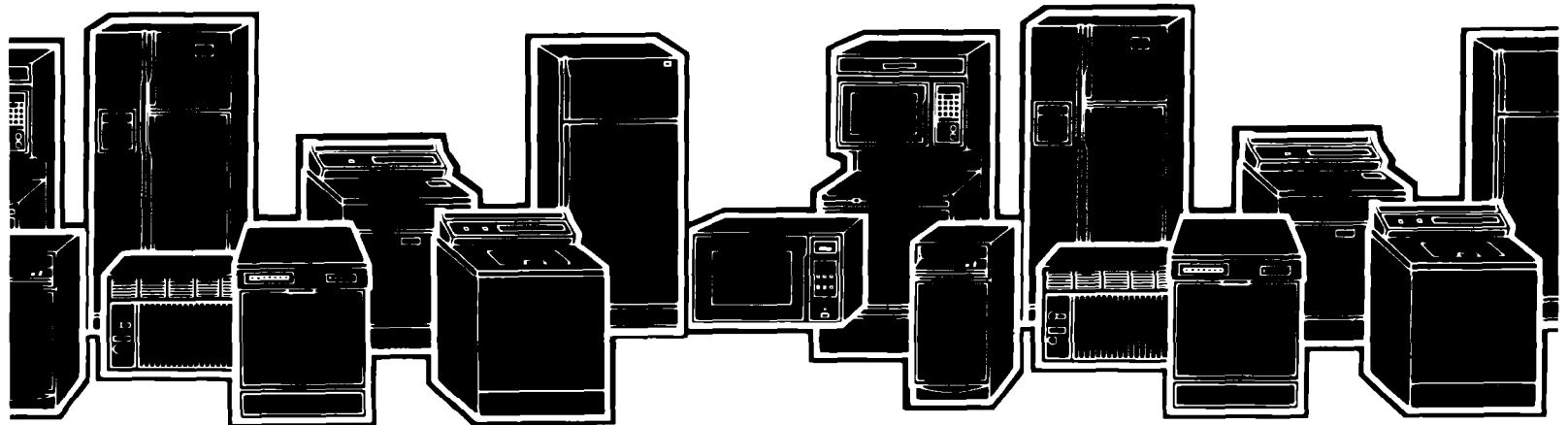

Contents

	Page		Page
PARTS AND FEATURES	2	MAGIC CLEAN® Lint Filter	8
IMPORTANT SAFETY INSTRUCTIONS	3	For Visually and Physically	
OPERATING INSTRUCTIONS	4	Impaired Consumers	8
Starting Your Washer	4	CARING FOR YOUR WASHER	9
What Happens in Each Cycle	6	Winterizing	10
OTHER OPERATING INSTRUCTIONS	8	IF YOU NEED SERVICE OR	
For a Rinse and Spin	8	ASSISTANCE	11
For a Drain and Spin	8	WASHER WARRANTY	12

©1987 Whirlpool Corporation

Parts and features

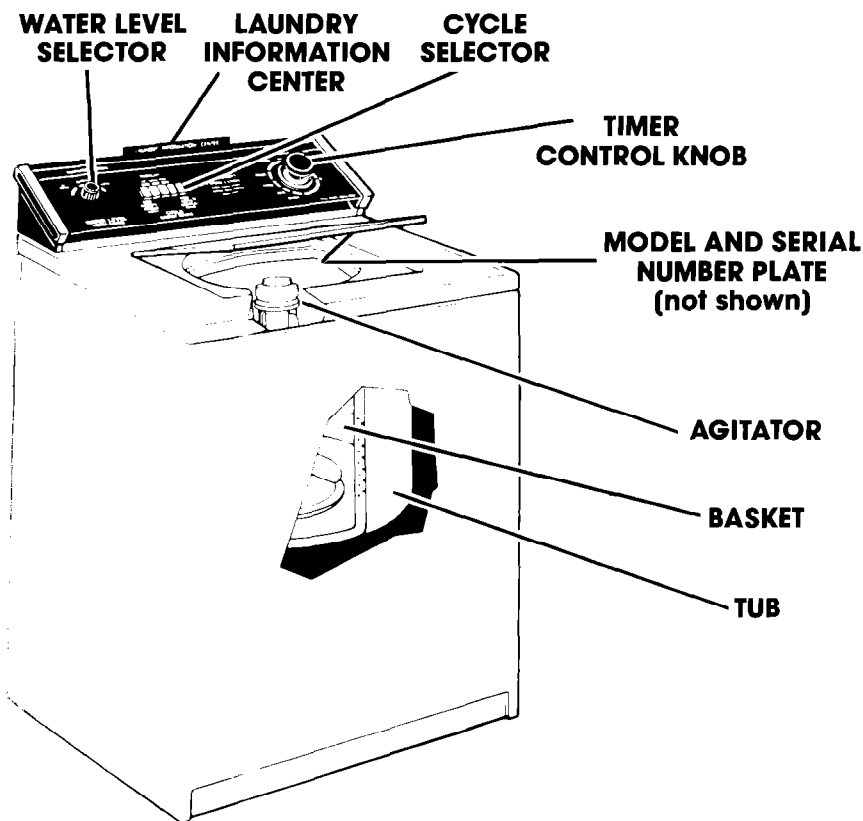

**MAGIC CLEAN®
LINT FILTER
(not shown)**

Remove the Consumer Buy Guide label. It will be easier to remove before the washer is used.

You should wipe out the basket with a damp cloth before using to remove dust from storing or shipping.

Copy your Model and Serial Numbers here

When you need service or call with a question, have this information ready:

- 1. Complete** Model and Serial Numbers (from plate under the lid near the hinge).
- 2.** Purchase date from the sales slip.

Copy this information in these spaces. Keep this book in the Laundry Information Center with your "Laundry Guide," sales slip and warranty.

Model Number

Serial Number

Purchase Date

Service Company Phone Number

Please complete and mail the Owner Registration Card furnished with this product.

Important safety instructions



WARNING – To reduce the risk of fire, electric shock, or injury to persons when using your washer, follow basic precautions, including the following:

Read these Laundry Instructions for important use and safety information before using your washer.

NEVER wash items cleaned, washed, soaked in or spotted with wax, paint, gasoline, or flammable fluids in the washer. The fumes can create a **FIRE HAZARD** or **EXPLOSION**. **ALWAYS** hand launder and air dry fabrics containing these materials.

NEVER allow children to operate, play with, or crawl inside the washer. Close supervision of children is necessary when the washer is used near children.

When discarding an old washer, **ALWAYS** remove the lid to prevent accidental entrapment.

NEVER put your hands into the washer until all motion stops. If the lid is opened while the basket is spinning, the basket will automatically stop in a few seconds.

DO NOT tamper with controls

NEVER use or store flammable fluids (dry-cleaning solvents, gasoline, kerosene) in or near your washer. Do not add flammable fluids to the wash water. These substances give off vapors that can create a **FIRE HAZARD** or **EXPLOSION**.

WARNING: If hot water has not been used recently (usually two weeks or longer), hydrogen gases may build up in the water heater and the hot water pipes. **HYDROGEN GAS IS EXPLOSIVE**. To prevent injury or damage, before using your washer, turn on all hot water faucets and allow water to run for several minutes. This will allow gases to escape. Do not smoke or use any open flame near the faucet while it is open.

You are personally responsible for making sure that your washer:

- is installed, repaired, and parts replaced by a qualified person.
- is properly installed and leveled on a floor that can support the weight.*
- is connected to the right kind of outlet, electric supply, water supply and drain.*
- is properly grounded.*
- is properly maintained.
- is protected from the weather and kept where the temperature will not fall below freezing.

*See the "Installation Instructions."

– SAVE THESE INSTRUCTIONS –

Additional Safety Instructions and Your Responsibilities

ALWAYS store detergent, laundry aids and other materials in a cool, dry place where children can't reach them – in a locked cabinet if possible.

ALWAYS read and follow instructions on packages of detergent and laundry aids – especially warnings and precautions.

HAZARDOUS FUMES can be formed if chlorine bleach is used in the same wash as ammonia or acids such as vinegar or rust remover.

ALWAYS unplug the power supply cord before attempting to service the washer.

DO NOT machine wash glass fiber materials. Small particles can stick to fabrics washed in following loads and cause skin irritation.

You are personally responsible for making sure that your washer:

- is used only for jobs normally expected of home automatic washers.
- is not run by children or anyone unable to operate it properly.

Operating instructions



Starting Your Washer

Be sure to measure and add detergent, then place a sorted load in the washer before starting it.



1. Select a WATER LEVEL

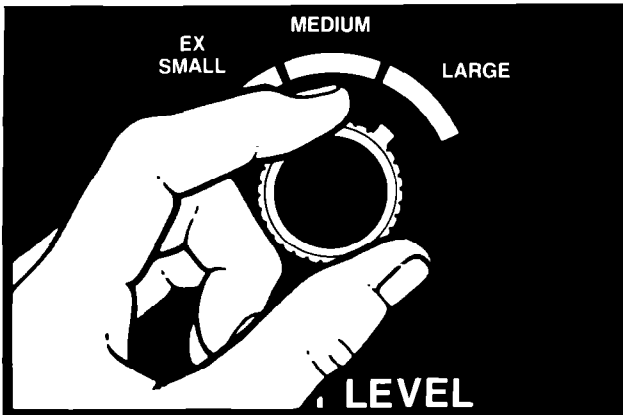

- Turn the knob to point to a setting that describes the size of the load you want to wash.
- The water level can be set for EX SMALL (a few items), MEDIUM or LARGE (a full load).

NOTE: Use the **LARGE** water level for best permanent press results.

2. Select a CYCLE

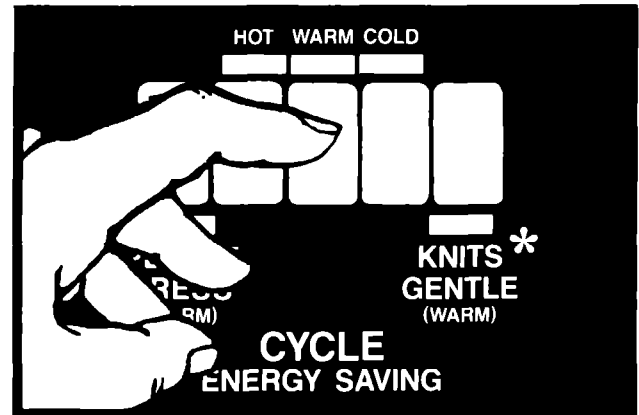

- Each cycle has preset wash and rinse water temperatures. (See pages 6 & 7 for more information.)
- All rinses are cold.

Recommended wash temperatures can be found in your "Laundry Guide."

IMPORTANT: Use warm water with the **PERM'T PRESS** or **KNITS GENTLE** cycles. For heavily soiled permanent press or knit clothes, pre-wash or pre-soak before washing in warm water.

LOAD SIZES AND WATER LEVELS

For best cleaning results, the load must be able to move freely in the water. Too big a load or too little water can cause wear or tearing of load items.

*Approximate fill with load.

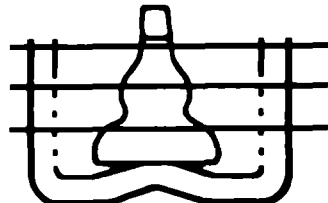

CAUTION:
DO NOT
OVERLOAD WASHER.

LARGE (17.3 gals./65.5 L)*
MEDIUM (13.4 gals./50.8 L)*
EX SMALL (9.5 gals./36.0 L)*

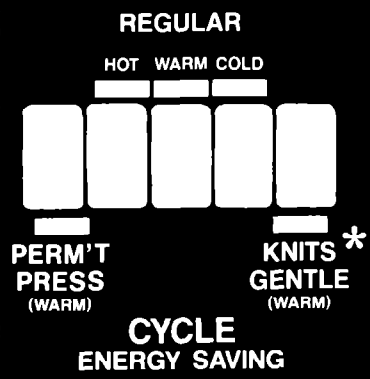

LARGE CAPACITY
2 SPEED 3 CYCLE
MAGIC CLEAN FILTER
GENTLE WASH SYSTEM
HEAVY DUTY

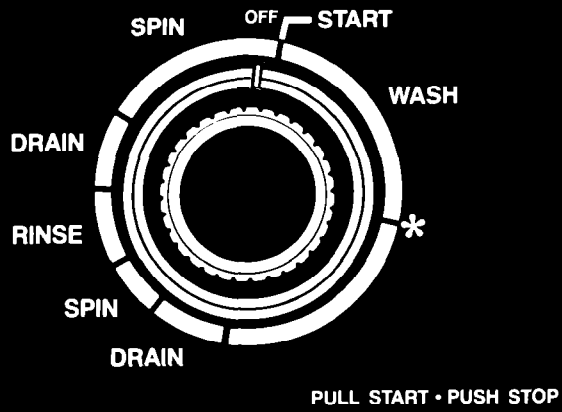

3. Start the Washer

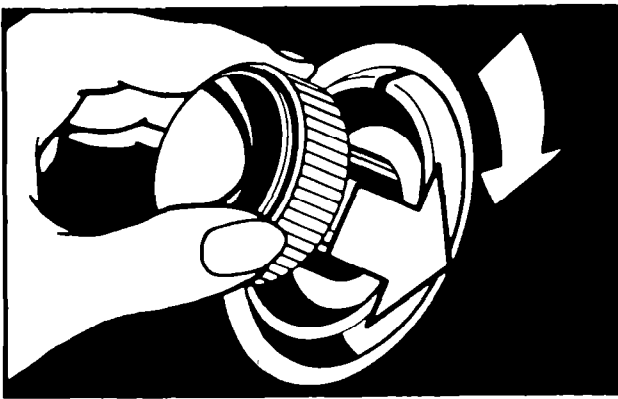

A. Push in the Timer Knob and turn it to the right. It must be pushed in and turned only clockwise.

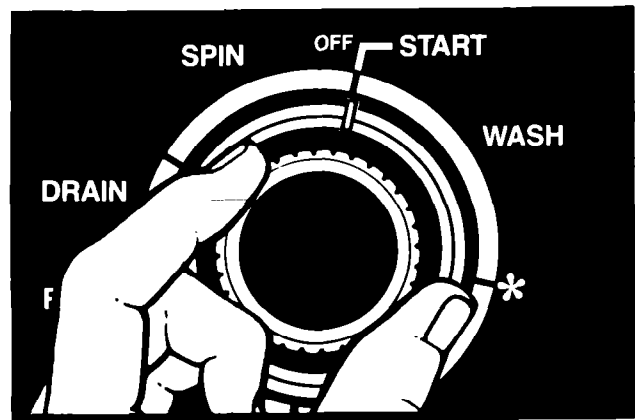

- For REGULAR and PERM'T PRESS cycles, turn the Timer Knob to the START line.
- For the KNITS GENTLE cycle, turn the Timer Knob to the *.
- Start the washer by pulling out the Timer Knob.

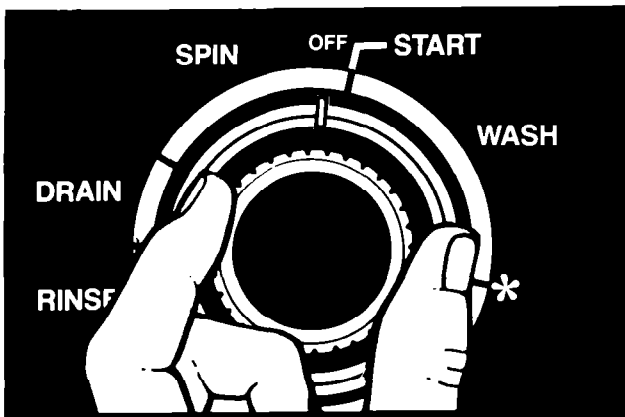

B. After starting the washer, it will fill to the level you set with wash water of the preset temperature. After finishing the entire cycle, the Timer Knob will move into the OFF area.

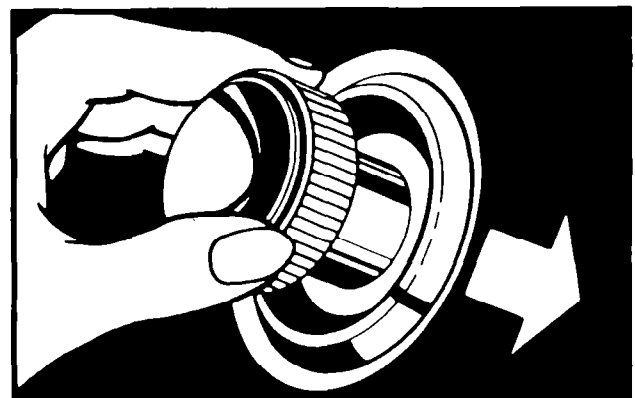

C. To stop the washer at any time, push in the Timer Knob. To restart the washer, pull out the Timer Knob.

What Happens in Each Cycle

Each cycle has been designed for different kinds of fabrics.

When a Cycle Selector Button is pushed and the Timer Control Knob pulled out, the washer fills before agitation and timing starts. After agitation starts, the Timer Knob turns clockwise until it points to OFF and the cycle ends.

REGULAR Cycles

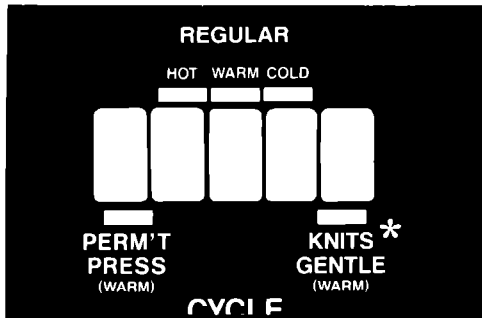

REGULAR (HOT WATER)
A cycle with a hot water wash and cold water rinse for sturdily constructed fabrics that are heavily soiled.

REGULAR (WARM WASH)
A cycle with a warm water wash and cold water rinse for sturdily constructed fabrics that are moderately soiled.

REGULAR (COLD WASH)
A cycle with a cold water wash and rinse for sturdily constructed items that are lightly soiled.

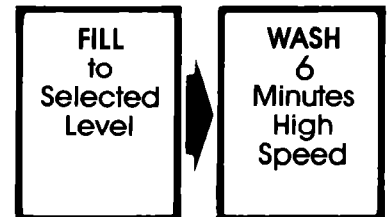

PERMANENT PRESS Cycle

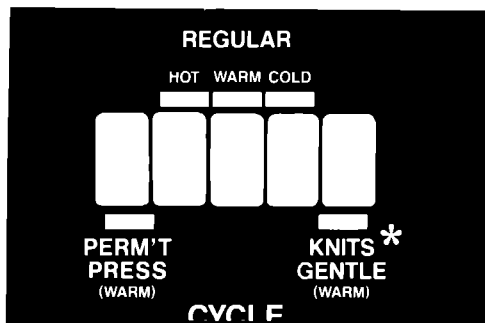

A cycle with warm water wash and cold water rinse. This cycle has **cool down** rinse which helps keep wrinkles from setting into permanent press and some synthetic fabrics.

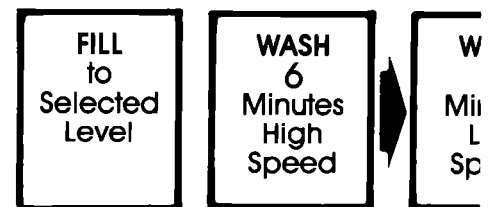

KNITS GENTLE Cycle

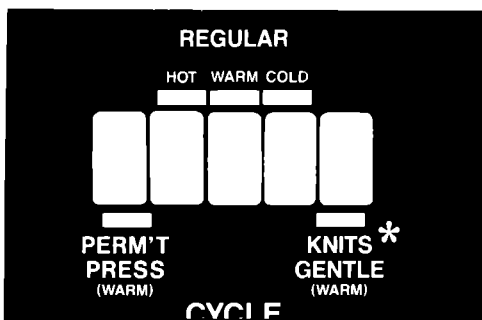

A cycle with a warm water wash and cold water rinse that gently washes and spins delicate items and washable knits.

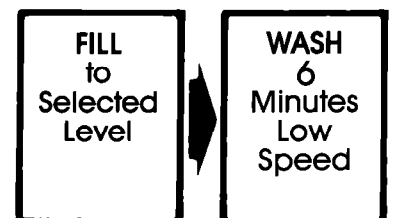

NOTE: You may hear the sound of water spraying during the spin parts of some cycles. In some cycles, cold water is sprayed on the spinning load to help rinsing.

Gentle Wash System

For better fabric care in REGULAR and PERMANENT PRESS cycles, the agitation speed is reduced during the last few minutes of wash time.

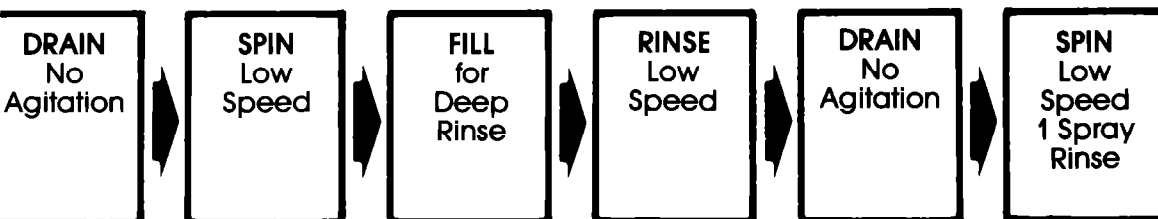
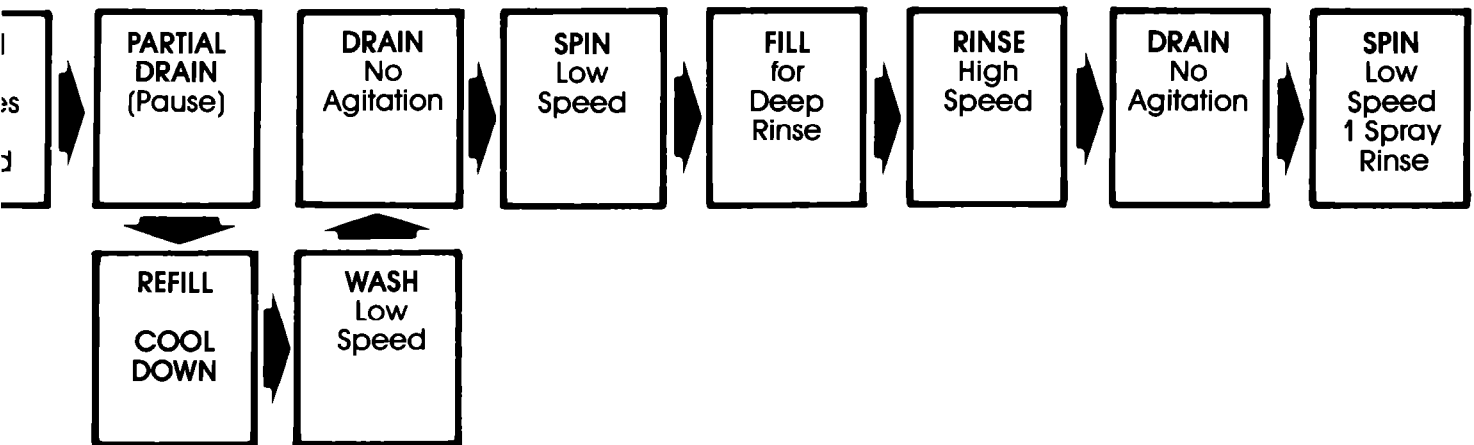
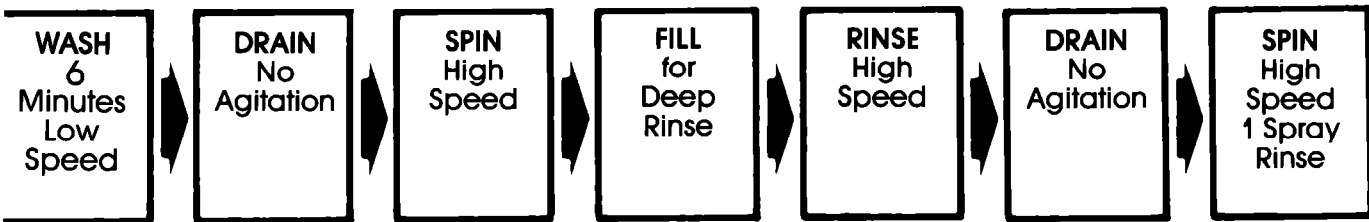

IMPORTANT: THE WASHER WILL PAUSE BRIEFLY THROUGHOUT EACH CYCLE. These pauses are normal. They allow for the reversing of the motor, normal washer operations, and cool down portion of the PERMANENT PRESS Cycle.

Other operating instructions

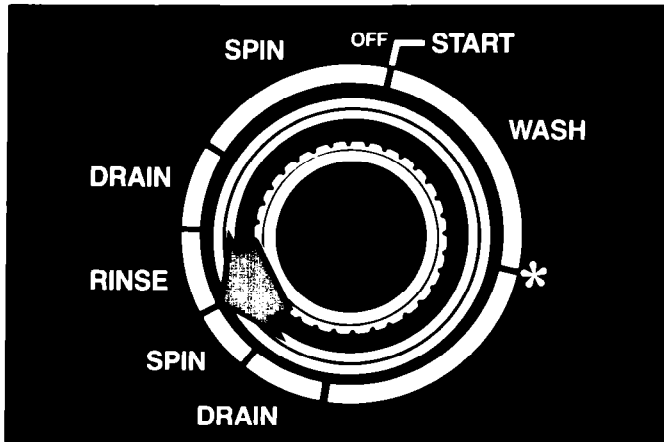

For a rinse and spin

You may need an extra rinse and spin for heavily soiled loads which need more detergent. (Extra detergent can require an extra rinse.)

- Push Timer Knob in.
- Turn clockwise to the Rinse portion of the cycle. **See above drawing.**
- Pull Timer Knob out.
- The washer will fill to selected level; agitate 2 minutes; drain and spin.

MAGIC CLEAN[™] lint filter

The lint filter in your washer cleans itself. Collected lint is drained away with the wash and rinse water. If your washer drains into a tub, remove any lint collected in the drain or strainer.

For visually and physically impaired consumers

The washer (LA6150XS) you have purchased features **easy to read**:

- control panel instructions
- Use & Care literature
- lid instructions

For consumers who have difficulty turning the control knobs, an **Easy Grip Knob** kit is available. The kit includes easy to grip rubber control knob covers for your washer and matching dryer (LE6150XS/LG6151KS).

For visually impaired consumers, audio cassettes and Braille Use & Care literature are also available.

If you need the **Easy Grip Knob** kit, **Braille** or **audio cassette** version of Use & Care literature in order to use this appliance,

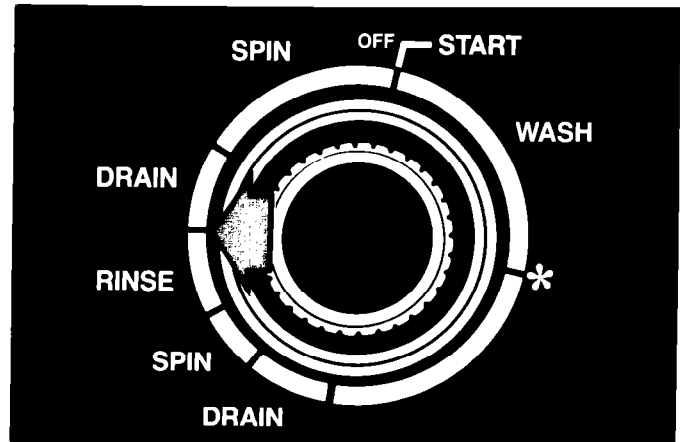

For a drain and spin

Your washer can be set to drain and spin out water.

- Push Timer Knob in.
- Turn clockwise to the second Drain portion of the cycle. **See above drawing.**
- Pull Timer Knob out.
- The washer will drain and spin.

For agitation and spin speeds in each cycle, see pages 6 and 7.

please write to:

Literature Department
Whirlpool Corporation
LaPorte Division
1900 Whirlpool Drive
LaPorte, IN 46350

Select one of the following materials:

Kit 389211 Easy Grip Knob kit*

Kit 787480 Audio Cassette Use & Care literature

Kit 787479 Braille Use & Care Literature

*One Easy Grip Knob kit contains knob covers for both your washer and the LE6150XS/LG6151XS dryer. If ordering for both appliances order only one kit.

Include your name, mailing address plus the model and serial numbers for your Whirlpool appliance to the address shown above. We will send the kit you select at no charge.

Caring for your washer

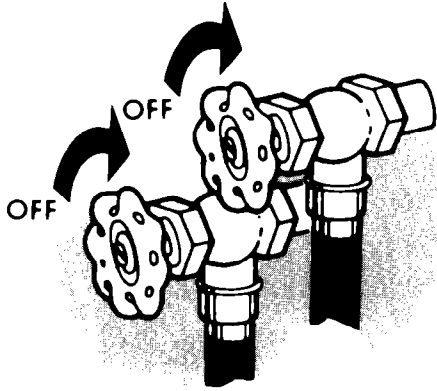

WHEN NOT WASHING, keep both water faucets turned off. This takes the pressure off the water inlet valve and hoses.

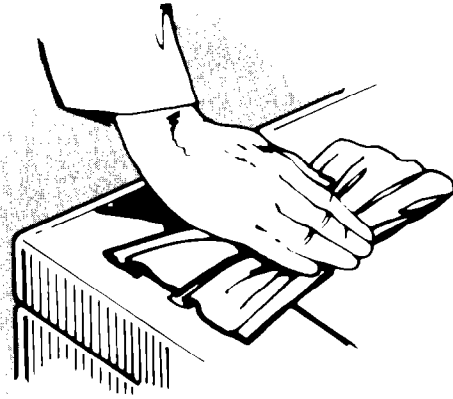

AFTER WASHING, use a soft dry cloth to wipe the outside and inside dry. Leave the lid up until the basket is dry. **Wipe up spills right away.** Spills can dull or damage the finish.

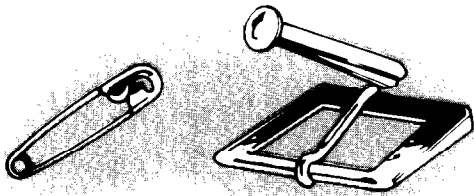

REMOVE SHARP OBJECTS such as pins, buckles, etc., from clothes before washing. Close metal zippers.

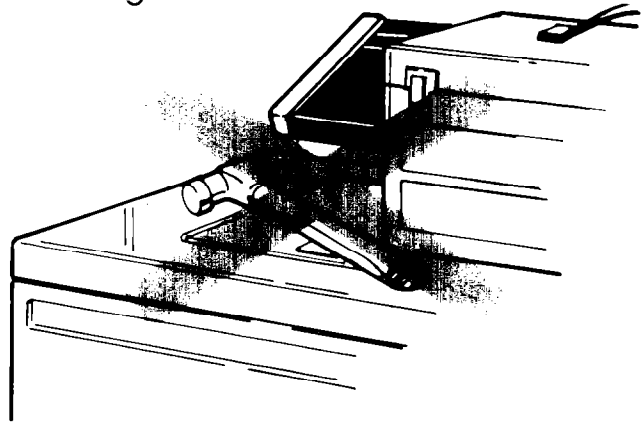

SHARP OR HEAVY OBJECTS should never be put on or in the washer. Check pockets for bolts, nuts, tools, etc.

NEVER USE THE WASHER TO...

- store wet or dry laundry.
- soak for more than 2 hours.
- soak with chlorine bleach.
- soak with vinegar or other acids.
- soak or store urine soaked clothes.

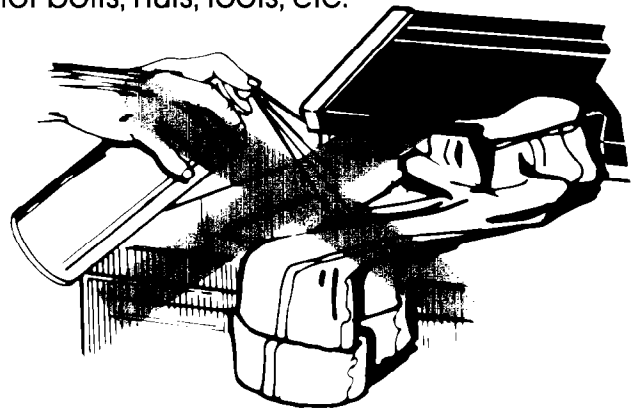

SOME PRETREATMENT PRODUCTS can damage washer and dryer dials, consoles and finishes. Do not use these products on or near your washer or dryer.

Service or performance problems caused by the use of any product not manufactured by Whirlpool Corporation are the responsibility of the manufacturer of that product.

Winterizing

Because some water stays in the washer, freezing can cause a lot of damage. If your washer is **stored or moved** during the cold weather...

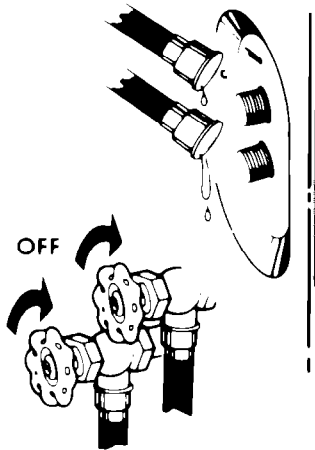
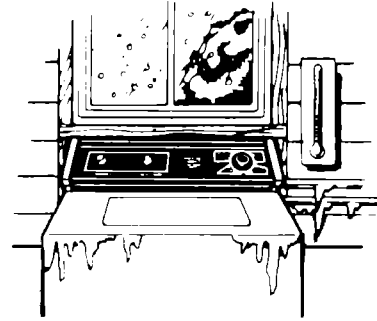

1. Shut off both water faucets. Disconnect and drain water inlet hoses.



2. Put a quart of R.V. or automobile type antifreeze in the basket.

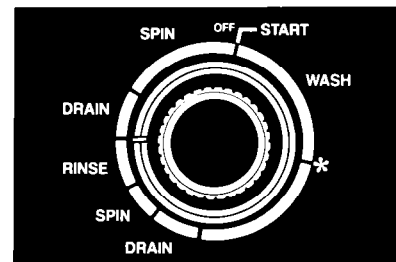

3. Set the washer for a DRAIN and SPIN (see page 8). Let it run for about 30 seconds to mix the antifreeze and water.

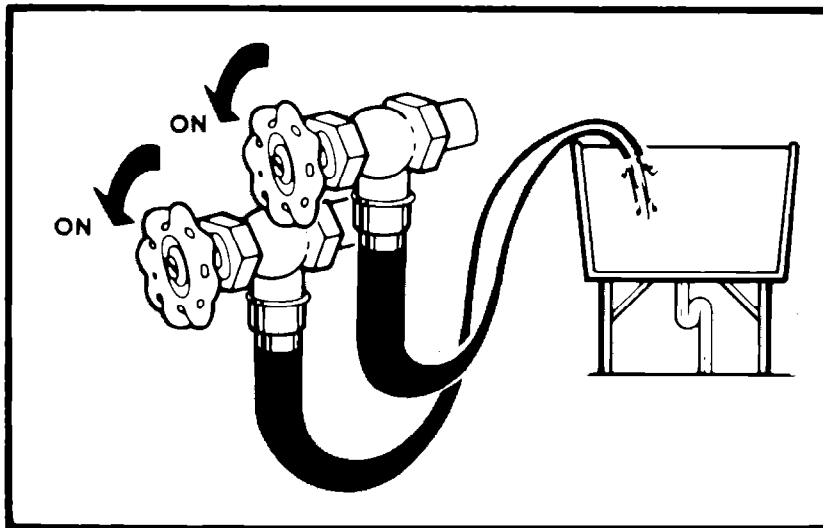

To use the washer again...

- 1.** Flush water pipes and hoses.
- 2.** Connect hoses to the washer.
- 3.** Turn on the water faucets.

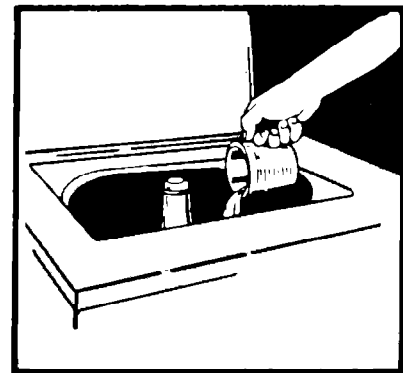

4. Run the water through a complete cycle with one cup of detergent to clean out the antifreeze.

If you need service or assistance, we suggest you follow these five steps:

1. Before calling for assistance...

Performance problems often result from little things you can find and fix yourself without tools of any kind.

If your washer does not fill:

- Is the power supply cord plugged into a live circuit with the proper voltage?
- Are both faucets open?
- Have you checked your home's main fuses or circuit breaker box?
- Are the water supply hoses kinked?
- Is the Timer Control Knob set and pulled out?

If your washer does not spin:

- Is the lid closed?
- Is the power supply cord plugged into a live circuit with the proper voltage?
- Have you checked your home's main fuses or circuit breaker box?

If your washer stops during a cycle:

- Remember, the washer pauses briefly at different times in each cycle. These pauses are normal.

If your washer fills and drains without running:

- Make sure that the Timer Control Knob is pointing to START or *.

Make sure the drain hose is higher than the water level in the washer. If it isn't:

- The washer may seem to be draining during wash and rinse cycles.
- Water can siphon out. (See "Installation Instructions.")

2. If you need assistance*...

Call Whirlpool COOL-LINE® service assistance telephone number. Dial free from anywhere in the U.S.:

1-800-253-1301

and talk with one of our trained Consultants. The Consultant can instruct you in how to obtain satisfactory operation from your appliance or, if service is necessary, recommend a qualified service company in your area.

3. If you need service*...



Whirlpool has a nationwide network of franchised TECH-CARE® Service companies. TECH-CARE service technicians

are trained to fulfill the product warranty and provide after-warranty service, anywhere in the United States. To locate TECH-CARE service in your area, call our COOL-LINE service assistance telephone number (see Step 2) or look in your telephone directory Yellow Pages under:

APPLIANCES – HOUSEHOLD – MAJOR – SERVICE & REPAIR	ELECTRICAL APPLIANCES – MAJOR – REPAIRING & PARTS
	OR
WHIRLPOOL APPLIANCES FRANCHISED TECH-CARE SERVICE	WHIRLPOOL APPLIANCES FRANCHISED TECH-CARE SERVICE
SERVICE COMPANIES	
XYZ SERVICE CO 123 MAPLE	999-9999
	OR
WASHING MACHINES, DRYERS & IRONERS – SERVICING	
WHIRLPOOL APPLIANCES FRANCHISED TECH-CARE SERVICE	
SERVICE COMPANIES	
XYZ SERVICE CO 123 MAPLE	999-9999

4. If you have a problem*...

Call our COOL-LINE service assistance telephone number (see Step 2) and talk with one of our Consultants, or if you prefer, write to:

Mr. Robert Stanley
Division Vice President
Whirlpool Corporation
2000 M-63
Benton Harbor, MI 49022

5. If you need FSP® replacement parts*...

FSP is a registered trademark of Whirlpool Corporation for quality parts. Look for this symbol of quality whenever you need a replacement part for your Whirlpool appliance. FSP replacement parts will fit right and work right, because they are made to the same exacting specifications used to build every new Whirlpool appliance.

*If you must call or write, please provide: model number, serial number, date of purchase, and a complete description of the problem. This information is needed in order to better respond to your request for assistance.

WHIRLPOOL® AUTOMATIC WASHER WARRANTY

LENGTH OF WARRANTY	WHIRLPOOL WILL PAY FOR
FULL ONE-YEAR WARRANTY From Date of Purchase	FSP® replacement parts and repair labor to correct defects in materials or workmanship. Service must be provided by a franchised TECH-CARE® service company.
LIMITED FIVE-YEAR WARRANTY From Date of Purchase	FSP replacement parts for any part of gearcase assembly if defective in materials or workmanship. The gearcase assembly is shown below.
LIMITED TEN-YEAR WARRANTY From Date of Purchase	FSP replacement of outer tub should it crack, or fail to contain water, due to defective materials or workmanship.
WHIRLPOOL WILL NOT PAY FOR	
<p>A. Service calls to:</p> <ol style="list-style-type: none"> 1. Correct the installation of the washer. 2. Instruct you how to use your washer. 3. Replace house fuses or correct house wiring or plumbing. <p>B. Repairs when washer is used in other than normal, single-family household use.</p> <p>C. Pick up and delivery. This product is designed to be repaired in the home.</p> <p>D. Damage to washer caused by accident, misuse, fire, flood, acts of God or use of products not approved by Whirlpool.</p> <p>E. Any labor costs during the limited warranties.</p>	

WHIRLPOOL CORPORATION SHALL NOT BE LIABLE FOR INCIDENTAL OR CONSEQUENTIAL DAMAGES. Some states do not allow the exclusion or limitation of incidental or consequential damages so this limitation or exclusion may not apply to you. This warranty gives you specific legal rights, and you may also have other rights which vary from state to state.

Outside the United States, a different warranty may apply. For details, please contact your franchised Whirlpool distributor or military exchange.

**GEARCASE ASSEMBLY
COVERED BY YOUR
WARRANTY**

