

Whirlpool 30-INCH BUILT-IN MICROWAVE AND
SELF-CLEANING OVENS
 Model RM278PXL

use & care guide

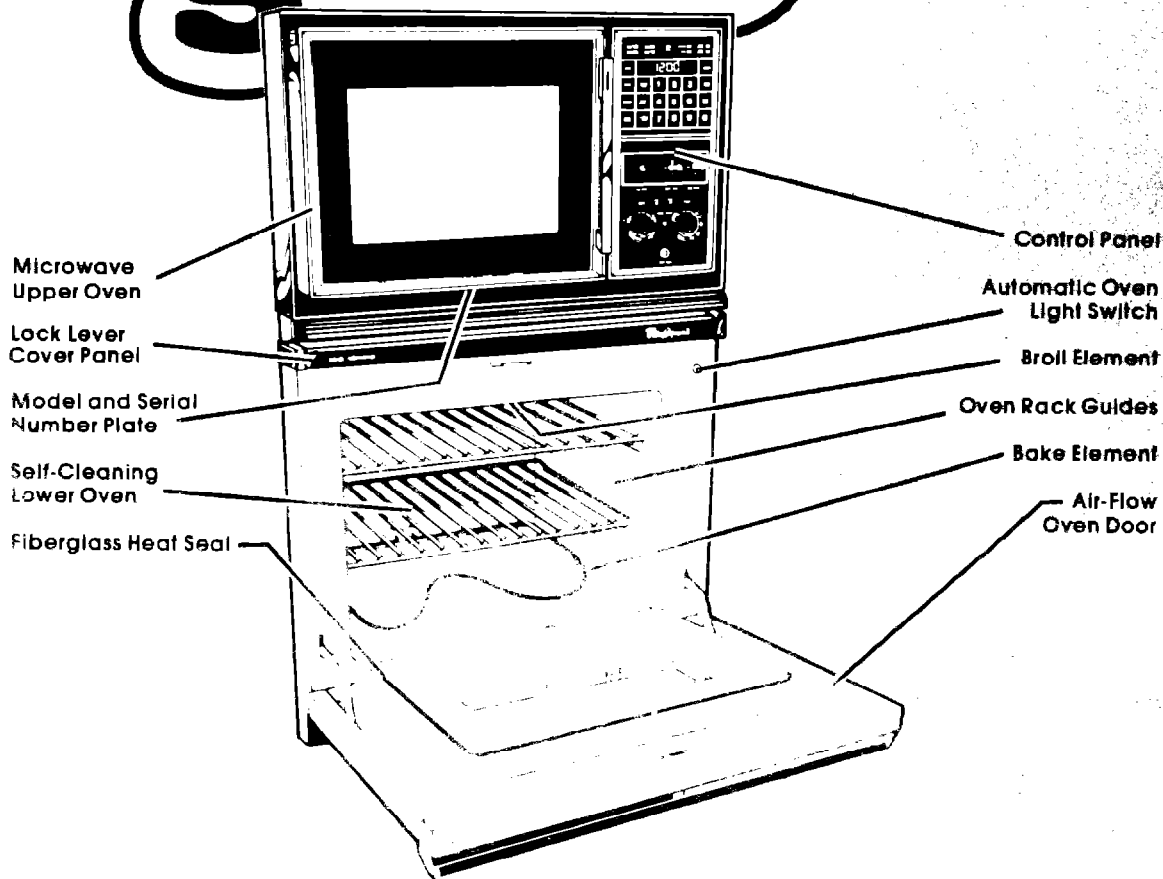

Copy Your Model and Serial Numbers Here

If you need service, or call with a question, have this information ready:

1. **Complete** Model and Serial Numbers (from the plate just behind the microwave oven door on the oven frame)
2. Purchase date from sales slip

Copy this information in these spaces. Keep this book, your warranty and sales slip together in a handy place.

Model Number

Serial Number

Purchase Date

Service Company and Phone Number

See Cooking Guide for important safety information.

Your responsibilities...

Proper installation and safe use of the oven are your personal responsibilities. Read this "Use and Care Guide" and the "Cooking Guide" carefully for important use and safety information.

Installation

You must be sure your oven is...

- installed and leveled in a wall or cabinet that will hold the weight;
- installed in a well-ventilated area protected from the weather;
- properly connected to the correct electric supply and grounding. (See "Installation Instructions.")

Proper use

You must be sure your oven is...

- used only for jobs expected of home ovens;
- used only by people who can operate it properly;
- properly maintained.

Contents

	Page		Page
Your Responsibilities	2	Using Your Lower Oven	22
Installation	2	The Lower Oven Controls	22
Proper Use	2	Baking or Roasting	23
Safety	3	Adjusting the Oven Temperature Control	23
Precautions to Avoid Possible Exposure to Excessive Microwave Energy	4	Using the Automatic MEALTIMER® Clock	24
Using the Microwave Upper Oven	4	Broiling	25
Setting the Clock	5	Broiling Chart	25
Using the Minute Timer	6	The Oven Lights	26
Cooking in One Cycle	7	The Oven Vent	26
High Cook Power	7	Cleaning and Caring for Your Oven	26
Lower Cook Powers	7	Control Panel and Knobs	26
Defrosting	9	The Lower Oven Self-Cleaning Cycle	27
Faster or Slower Defrosting	9	Cleaning Chart	30
Cooking in Two Cycles	10	The Optional Rotisserie	30
Cooking Automatically After Defrosting	12	If You Need Service or Assistance	31
Cooking to a Serving Time	14	1. Before Calling for Assistance	31
Serve Time and the Temperature Probe	15	2. If You Need Assistance	32
Cooking with the Temperature Probe	16	3. If You Need Service	32
Changing or Cancelling Instructions	18	4. If You Have a Problem	32
Other Operating Hints	18		
Cleaning the Microwave Oven	18		
Important Information	19		
How Microwave Ovens Work	21		
Bi-Level Oven Rack	21		

Safety



DO NOT allow children to use or play with the oven.

DO NOT store things children might want above the oven. *Too much weight on an open oven door can damage the door.*

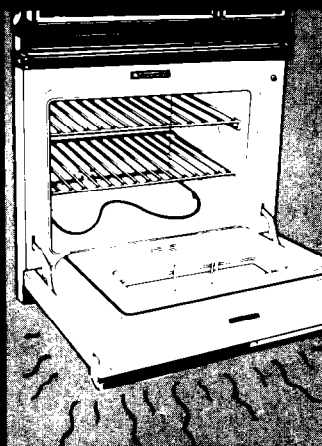

The oven frame, walls, racks and parts of the door can get hot enough to cause burns.

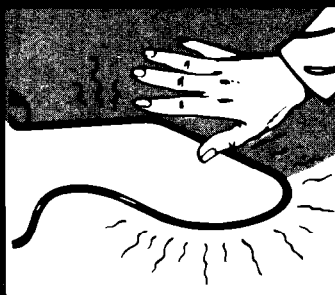

- Don't touch any part of the oven, especially heating elements, until you know they are completely cool.

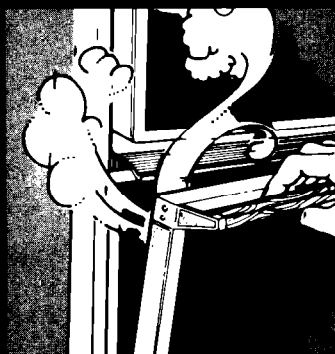

Let steam and hot air escape from the oven before moving food.

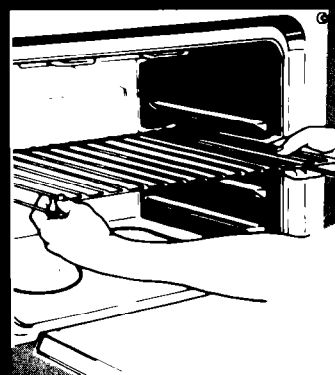

- Put oven racks where you want them before turning on the oven.



DO NOT use wet pot-holders. They can cause steam burns.

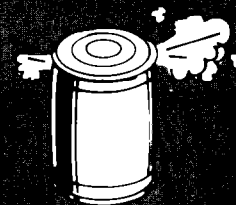

DO NOT heat unopened containers. They can explode.

DO NOT operate the microwave upper oven until you have read and understand **ALL** the information on safe use. Serious damage to the oven or injury to the user can result from not following directions.

DO NOT cook eggs in the shell in the microwave oven. Steam build-up in the egg will cause it to burst. Damage to the oven or injury to the user may result. Slice hard-boiled eggs before reheating to avoid steam build-up and possible bursting.

Remove the Consumer Buy Guide Label before using your oven.

PRECAUTIONS TO AVOID POSSIBLE EXPOSURE TO EXCESSIVE MICROWAVE ENERGY...

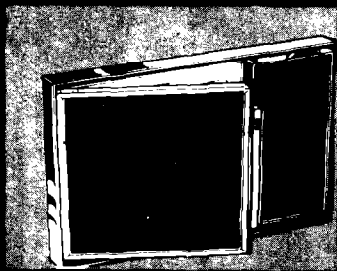

DO NOT attempt to operate this oven with the door open since open-door operation can result in harmful exposure to microwave energy. It is important not to defeat or tamper with the safety interlocks.

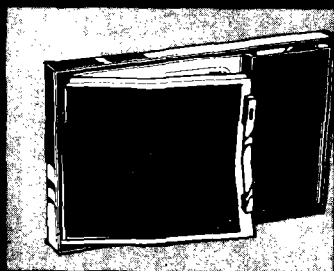

DO NOT operate the oven if it is damaged. It is particularly important that the oven door close properly and that there is no damage to the

- (1) Door (bent),
- (2) Hinges and latches (broken or loosened),
- (3) Door seals and sealing surfaces.

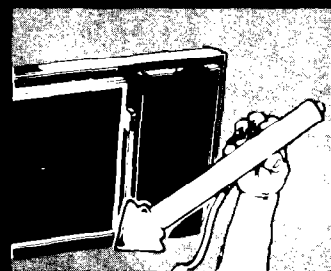

The microwave oven should be checked for microwave leakage by qualified service personnel after a repair is made.

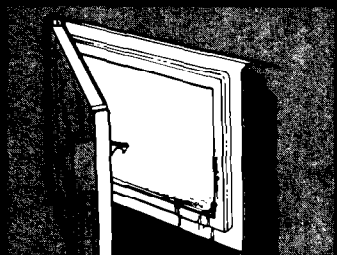

DO NOT place any object between the oven front face and the door or allow soil or cleaner residue to accumulate on sealing surfaces.

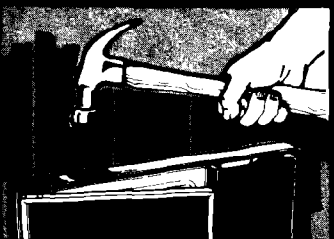

The oven should not be adjusted or repaired by anyone except properly qualified service personnel.

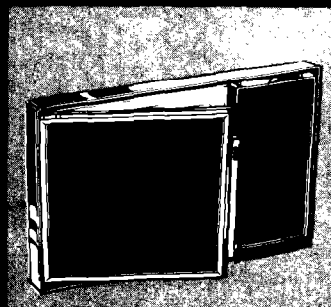

DO NOT operate the microwave oven if the door glass is broken.

DO NOT operate the microwave oven with the outer cabinet removed.

Using the microwave upper oven

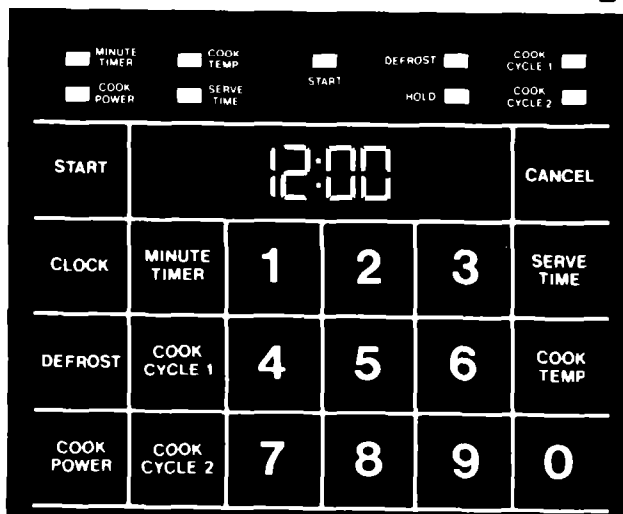

Microwave Oven Controls

The top part of the Control Panel has the microwave oven controls. There are four kinds of controls:

- The Digital Display / Clock.
- Signal Lights,
- Command Pads,
- Number Pads.

What each of these does will be covered on the following pages. One note: The Command and Number Pads **are not buttons**. You don't have to push them...just touch them.

When you first plug in the range, the Clock/Display will show 88:88. If, after you set the clock (page 5), the Clock again shows all 8's, it means your electricity was off for a while. Reset the clock.

Read the following pages carefully.

DIGITAL DISPLAY / CLOCK

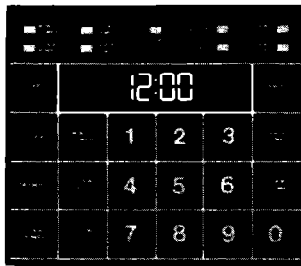

– it shows you what number pads you touched.

When you are not using the microwave oven, this is an accurate digital clock.

When you are using the microwave oven, this acts as a display.
– It counts down time settings, and

COMMAND PADS

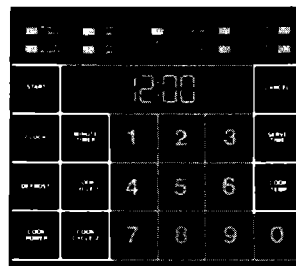

tells the oven you are going to cook at less than full power.
– START tells the oven to start.
– DEFROST tells the oven to run at 30% of full power.

Touch Command Pads to tell the microwave oven what to do and in what order.

A few examples:

– CLOCK tells the oven you are going to set the Clock.
– COOK POWER

NUMBER PADS

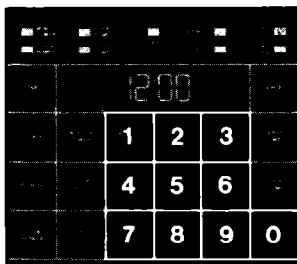

Once you've touched a Command Pad to tell the oven what you want it to do, you'll touch Number Pads to tell it...

– a cooking time,
– a Cook Power,
– a food temperature.

SIGNAL LIGHTS

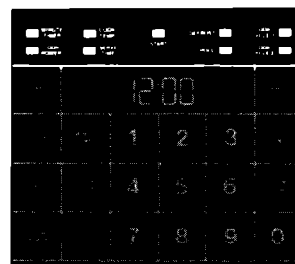

A Signal Light comes on every time you touch a Command Pad.

While the oven is running, the Signal Light or lights will be on to show you what the oven is doing.

SETTING THE CLOCK

When the oven is first plugged in, the Clock / Display shows **88:88**. If the electric power ever goes off, the Clock / Display will also show all 8's when the power comes back on.

You can cook or use the Minute Timer without setting the clock, but the display will be blank after cooking. **The oven door must be closed before setting the clock.**

DO THIS...

THIS HAPPENS...



1. Touch CLOCK.



The word "set" will glow on the display. Start touching number pads for the desired time within 5 seconds.



2. Touch number pads for the correct time of day.



The Display will show what numbers you touched **in the order you touched them**. This example shows 3:25.



3. Touch START.









The START Signal Light will come on to show that you have touched START. It will go off in about 5 seconds. The clock is set.

USING THE MINUTE TIMER

The Minute Timer does not start or stop cooking; it works like a kitchen timer. Set in minutes or seconds and a buzzer sounds when the set time is up. The oven door must be closed before setting the Minute Timer.

DO THIS...

THIS HAPPENS...

-
- | | |
|---|--|
| 
1. Touch MINUTE TIMER. | 

The MINUTE TIMER Signal Light will come on and the Display will show a "0." Within 5 seconds start touching number pads for the desired time. |
| 
2. Touch number pads for minutes and seconds. | 
The Display will show what numbers you touched in the order you touched them . This example shows 1 minute, 45 seconds. |
| 
3. Touch START. | 
The START and MINUTE TIMER Signal Lights will come on to show that <ul style="list-style-type: none">• you have touched START;• the Minute Timer is running. The START Light will go off in about 5 seconds.

The Display counts down the seconds to show how much time is left on the Minute Timer.

When the set time is up, a buzzer will sound and the Display will show the time of day. |
-

- 1.** The Minute Timer can be used when the oven is cooking.
- 2.** Opening the microwave oven door does not stop the Minute Timer.
- 3.** If you open oven door and reset the Minute Timer touch START twice to start the Minute Timer and to restart the oven.

To change or cancel the Minute Timer:

1. Touch MINUTE TIMER.
2. Touch number 0 to cancel,
or
2. Touch desired new number pads to change.







Then:

3. Touch START.

COOKING IN ONE CYCLE

Follow these steps to cook at one power level:

HIGH COOK POWER

DO THIS...	THIS HAPPENS...
1. Put food in the oven and close the door.	
	 <p>The COOK CYCLE 1 Signal Light will come on and the Display will show four 0's.</p>
2. Touch COOK CYCLE 1.	
	 <p>The Display will show the numbers you touched in the order you touched them. This example shows 4 minutes, 30 seconds.</p>
3. Touch number pads for the cooking time you want.	
	<p>The oven will automatically cook at high Cook Power.</p>  <p>The START and COOK CYCLE 1 Signal Lights will come on to show what you have told the oven to do. The START Light will go off in about 5 seconds.</p>
4. Touch START.	<p><i>count down</i></p> <p>The Display counts down the time to show how much cooking time is left.</p> <p><i>BUZZ BUZZ BUZZ BUZZ</i></p> <p>When the cooking time ends, a buzzer will sound 4 times. (You can stop the buzzer by opening the oven door or touching CANCEL.) When the buzzer stops, the Display will show the time of day.</p>

LOWER COOK POWERS

For best results, some recipes call for lower Cook Powers. Lowering the Cook Power slows the cooking. The lower the Cook Power, the slower the cooking. Each number pad on your microwave oven stands for a different percentage of Cook Power. Many recipes in your MICRO MENUS* Cookbook tell you, by number, which Cook Power to use. Recipes in other books and magazines may tell you by name (HI, MED, LO, etc.) or by percentage (10%, 50%, 80%, etc.).

The following chart gives you the percentage of Cook Power each number pad stands for, and the Cook Power name usually used.

automatic	=	100% of full power	HIGH
9	=	90% of full power	
8	=	80% of full power	
7	=	70% of full power	MED-HI
6	=	60% of full power	
5	=	50% of full power	MED
4	=	40% of full power	
3	=	30% of full power	MED-LO
2	=	20% of full power	
1	=	10% of full power	LOW

*Tmk.

CONTINUED NEXT PAGE

DO THIS...

THIS HAPPENS...

- 1. Put food in the oven and close the door.**



The COOK CYCLE 1 Signal Light will come on and the Display will show four 0's.



- 2. Touch COOK CYCLE 1.**



The Display will show the numbers you touched **in the order you touched them**. This example shows 7 minutes, 30 seconds.

- 3. Touch number pads for the cooking time you want.**



The COOK POWER Signal Light will come on and the Display will show two 0's.



- 4. Touch COOK POWER.**



The Display will show what you touched. This example shows 60% of full power.

- 5. Touch a number pad for the Cook Power you want.**



The START, COOK CYCLE 1 and COOK POWER Signal Lights will come on to show what you have told the oven to do. The START Light will go off in about 5 seconds.

- 6. Touch START.**



The Display counts down the time to show how much cooking time is left.



For 2 of every 10 seconds, the Display will show the Cook Power you selected.



When the cooking time ends, a buzzer will sound 4 times. (You can stop the buzzer by opening the door or by touching CANCEL.) When the buzzer stops, the Display will show the time of day.

DEFROSTING

Use the defrost setting to thaw frozen food before cooking. For suggested defrost times, check the guide on the inside of the oven door or in your MICRO MENUS* Cookbook.

*Tmk

DO THIS...

THIS HAPPENS...

1. Put frozen food in the oven and close the door.



2. Touch DEFROST.



The DEFROST Signal Light will come on and the Display will show four 0's.



3. Touch number pads for the defrosting time you want.



The Display will show the numbers you touched **in the order you touched them**. This example shows 2 minutes, 30 seconds.



4. Touch START.



The START and DEFROST Signal Lights will come on to show what you have told the oven to do. The START Light will go off in about 5 seconds.



The Display counts down the time to show how much defrosting time is left.



When the defrost time ends, a buzzer will sound 4 times. (You can stop the buzzer by opening the oven door or touching CANCEL.) When the buzzer stops, the Display will show the time of day.

FASTER OR SLOWER DEFROSTING

When you touch DEFROST, the microwave oven automatically uses 30% of full Cook Power. For slower or faster defrosting, see **Lower Cook Powers** on page 7.

- Use 20% of full power for slower defrosting.
- Use 40% of full power for faster defrosting. **Defrosting at Cook Powers higher than 30% can cause some cooking on the outside of the food.**

HOLDING OR STANDING TIME:

For best results allow the food to stand for awhile after defrosting. This will equalize the temperature of the food and provide more even defrosting.

COOKING IN TWO CYCLES

For best results, some recipes call for one Cook Power for a certain length of time, and another Cook Power for another length of time. Your oven can be set to change from one to the other automatically.

DO THIS...

THIS HAPPENS...

-
1. Put food in the oven and close the door.
-



The COOK CYCLE 1 Signal Light will come on and the Display will show four 0's.

2. Touch COOK CYCLE 1.
-



The Display will show the numbers you touched **in the order you touched them**. This example shows 3 minutes, 25 seconds.

3. Touch number pads for the cooking time you want in the first cycle.
-



The COOK Power Signal Light will come on and the Display will show two 0's.

4. Touch COOK POWER. If you want the high Cook Power, skip to step 6.
-



The Display will show what you touched. This example shows 60% of full power.

5. Touch a number pad for the Cook Power you want in the first cycle.
-



The COOK CYCLE 2 Signal Light will come on and the Display will show four 0's.

6. Touch COOK CYCLE 2.
-



The Display will show the numbers you touched **in the order you touched them**. This example shows 4 minutes, 30 seconds.

7. Touch number pads for the cooking time you want in the second cycle.



8. Touch COOK POWER. If you want the high Cook Power, skip to step 10.



The COOK POWER Signal Light will come on and the Display will show two 0's.



9. Touch a number pad for the Cook Power you want in the second cycle.



The Display will show what you touched. This example shows 40% of full power.



10. Touch START.



The START Signal Light will come on for about 5 seconds. The COOK CYCLE 1 Light will come on and stay on while the oven is cooking in the first cycle. The COOK POWER Light will be on if you are using a Cook Power other than high.



The Display counts down the cooking time to show how much time is left in the first cycle.



For 2 of every 10 seconds, the Display will show the Cook Power you selected, if you are using a Cook Power other than high.



A buzzer will sound at the end of the first cycle. You can either open the door to check the food, or you can let the oven start the second cycle. If you do open the door, just close it and push START to restart the oven.



The COOK CYCLE 2 Light will come on when the oven starts cooking in the second cycle. The COOK POWER Light will come on if you are using a Cook Power other than high.



The Display counts down the cooking time to show how much time is left in the second cycle.



For 2 of every 10 seconds, the Display will show the Cook Power you selected, if you are using a Cook Power other than high.



When the second cycle is over, a buzzer will sound 4 times. (You can stop the buzzer by opening the door or touching CANCEL.) When the buzzer stops, the Display will show the time of day.

COOKING AUTOMATICALLY AFTER DEFROSTING

The controls can be set so the microwave oven goes automatically from defrosting to Cook Cycle 1 and even Cook Cycle 2.

DO THIS...

THIS HAPPENS...

1. Put frozen food in the oven and close the door.



2. Touch DEFROST.



The DEFROST Signal Light will come on and the Display will show four 0's.



3. Touch number pads for defrosting time you want.



The Display will show the numbers you touched **in the order you touched them**. This example shows 2 minutes, 30 seconds.



4. Touch COOK CYCLE 1.



The COOK CYCLE 1 Signal Light will come on and the Display will show four 0's.



5. Touch number pads for the cooking time you want in the first cycle.



The Display will show the numbers you touched **in the order you touched them**. This example shows 3 minutes, 25 seconds.



6. Touch COOK POWER.
Options: Skip to step 8 if you want the first cycle to cook at high power. Skip to step 12 if you want only one cycle at high power.



The COOK POWER Signal Light will come on and the Display will show two 0's.



7. Touch a number pad for the Cook Power you want in the first cooking cycle.



The Display will show what you touched. This example shows 60% of full power.



The COOK CYCLE 2 Signal Light will come on and the Display will show four 0's.



- 8. Touch COOK CYCLE 2.**
Option: Touch START
If cooking in only one cycle after defrosting.



The Display will show the numbers you touched **in the order you touched them**. This example shows 4 minutes, 30 seconds.

- 9. Touch number pads for the cooking time you want in the second cooking cycle.**



The COOK POWER Signal Light will come on and the Display will show two 0's.



- 10. Touch COOK POWER.**
Option: Touch START if you want the high Cook Power.



The Display will show what you touched. This example shows 40% of full power.

- 11. Touch a number pad for the Cook Power you want in the second cooking cycle.**



The START and DEFROST Signal Lights will come on. DEFROST will stay on during the defrost cycle. START will go off in about 5 seconds.

- 12. Touch START.**



The Display counts down the time to show how much time is left in the defrost cycle.



When the defrost cycle is over, the microwave oven automatically holds the food for the **same amount of time used for defrosting**. The Display counts down the hold time and the HOLD Signal Light will be on.



When the hold time is over, a buzzer will sound and the first cooking cycle will start.



The COOK CYCLE 1 Signal Light will come on and stay on during the first cooking cycle. The COOK POWER Light will also come on **if you are using a Cook Power other than high**.

count
down

The Display counts down the time to show how much time is left in the first cooking cycle.

60:

For 2 of every 10 seconds, the Display will show the Cook Power you selected if you are using a Cook Power other than high.

BUZZ

When the first cooking cycle is over, a buzzer will sound and the second cooking cycle will start. (If only one cooking cycle is used, 4 buzzes will sound, and the oven will stop.)

COOK CYCLE 2 COOK POWER

The COOK CYCLE 2 Signal Light will come on and stay on during the second cooking cycle. The COOK POWER Light will also come on **if you are using a Cook Power other than high.**

count
down

The Display counts down the time to show how much cooking time is left in the second cycle.

40:

For 2 of every 10 seconds, the Display will show the Cook Power you selected if you are using a Cook Power other than high.

BUZZ
BUZZ
BUZZ
BUZZ

When the cooking time is over, a buzzer will sound 4 times. (You can stop the buzzer by opening the oven door or touching CANCEL.) When the buzzing stops, the Display will show the time of day.

The holding time allows food temperature to even out all the way through the food.

To skip the holding time:

- Instruct the microwave oven to DEFROST and to cook in **COOK CYCLE 2.**

To check or stir foods between or during cycles:

1. Open the door. The oven will shut off.
2. Check, stir or rotate the food.
3. Close the door.
4. Touch START. The oven will go on from where it stopped.

COOKING TO A SERVING TIME

The microwave oven controls can be set to start and stop the oven automatically, even when you are not home. The Serve Time feature allows you to set the time you want the food to be finished cooking.

DO THIS...

THIS HAPPENS...

SERVE
TIME

SERVE
TIME

00:00

The SERVE TIME Signal Light will come on and the Display will show four 0's. Decide what time you want the food to be done cooking.

1. Touch **SERVE TIME.**



The Display will show the numbers you touched **in the order you touched them**. This example shows a Serve Time of 6:00.

2. Touch number pads for the time you want the food to be ready to serve.

3. Touch in the cooking instructions needed for the food to be cooked.

Cook in Defrost, Cook Cycle 1, Cook Cycle 2, or a combination of them. Use high Cook Power or lower Cook Powers.



4. Touch START.



If the Display begins flashing, there isn't enough time left before the Serve Time for the oven to do what you told it to do. Touch CANCEL and start over with a later Serve Time.



The START and SERVE TIME Signal Lights will stay on. All the other lights will go off. When cooking starts, the Signal Lights and Display will go on to show what is happening.

Extra information:

- Make sure the Clock is set to the right time of day.
- You can't set the Serve Time for more than 12 hours after the correct time of day.
- If you open the door before the oven begins to cook, be sure to retouch START.
- If you want the microwave oven to start cooking when you are not home:

Use foods that will not go bad or spoil while waiting for cooking to start. Avoid

using dishes with milk or eggs, cream soups, cooked meats, poultry or fish, or any item with baking powder or yeast.

Smoked or frozen meats may be used; so can vegetables, fruits and casserole-type foods.

Any food that has to wait for cooking to start should be very cold or frozen before it is put in the oven. **MOST UNFROZEN FOODS SHOULD NEVER STAND MORE THAN TWO HOURS BEFORE COOKING STARTS.**

SERVE TIME AND THE TEMPERATURE PROBE

1. Follow instructions on pages 16-17 for plugging in the Temperature Probe.
2. Touch SERVE TIME.
3. Touch the number pads for the time you want the food finished.
4. Follow instructions on pages 16-17 for touching in temperature and cook power instructions.

5. Touch START.

NOTE: When cooking toward a Serve Time while using the Temperature Probe, the microwave oven will start cooking 90 minutes before the Serve Time you set. If cooking time will be less than 90 minutes, set a later Serve Time.

COOKING WITH THE TEMPERATURE PROBE

The MEAL SENSOR[®] Temperature Probe helps take guesswork out of cooking roasts and larger casseroles. The probe is designed to turn off the oven when it senses the temperature you want. See your MICRO MENUS[™] Cookbook for helpful information in cooking different types of foods.

Number Pads are used to touch in the final food temperature you want.

Touch...	To Get Approximately...	Touch...	To Get Approximately...
1	90 F (32 C)	5	145 F (63 C)
2	110 F (43 C)	6	150 F (66 C)
3	120 F (49 C)	7	160 F (71 C)
4	130 F (54 C)	8	165 F (74 C)
		9	185 F (85 C)

DO THIS...

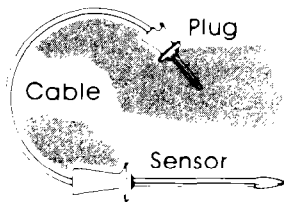

1. Insert at least 1/3 of the temperature probe into the food.

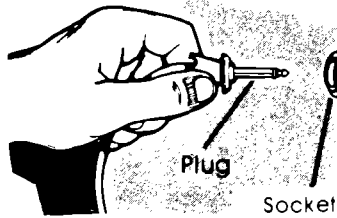

2. Place food in the oven and plug the probe into the socket on the oven wall.

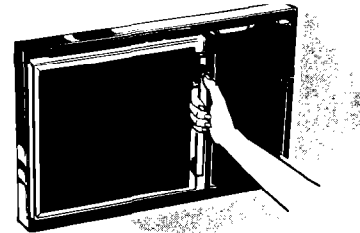

3. Make sure the probe does not touch any part of the oven interior. Close the door.

DO THIS...



4. Touch COOK TEMP.



The COOK TEMP Signal Light will come on and the Display will show 2 0's.



5. Touch a number pad for the desired final temperature.



The Display will show the number you touched. This example uses 6, or a final cooked temperature of about 150 F (66 C). The 0 means the food is still cold.



6. Touch COOK POWER.
Option: Touch START if you want to use full power.



The COOK POWER Signal Light will come on and the Display will show two 0's.



7. Touch the number pad for the Cook Power you want.



The Display will show what you touched. This example shows 60% of full power.



8. Touch START.

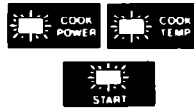

The COOK POWER, COOK TEMP and START Lights will come on. The START Light will go off in about 5 seconds, the others will stay on.



The left number on the display shows what temperature (number) you selected. The right number shows you how the temperature is rising in the food.



For 2 of every 10 seconds, the Display will show the Cook Power you selected if you are using a Cook Power other than high.



When the probe senses the temperature you selected, the oven shuts off and 4 buzzes sound. (You can stop the buzzer by opening the oven door or touching CANCEL.) When the buzzes stop, the Display will show the time of day.



HINTS FOR USING THE TEMPERATURE PROBE

DO...

- use hot pads when removing probe from food or food from oven.
- stir foods during cooking when recommended.
- stir soups, casseroles and drinks before serving.
- cover roasts with foil and let stand a few minutes after cooking. Remove foil if you decide to cook it longer.

DON'T...

- let probe or probe cable touch any part of the oven interior.
- let probe touch foil (if used). Foil can be kept away from probe with wooden toothpicks. Remove foil if arcing occurs.
- use paper, plastic wrap or plastic containers. They will be in the oven too long.
- use probe in regular oven.
- force probe into frozen food.
- use probe for foods that need to simmer.

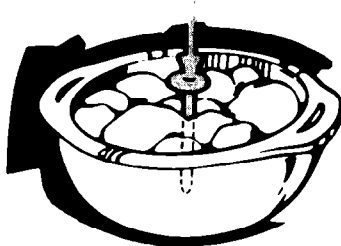

For casseroles, the tip of the probe should be in the center of the food. Stir foods when recommended. Replace the probe.

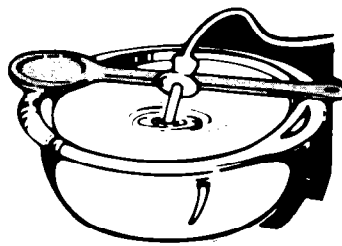

For liquids, balance the probe on a **wooden** spoon or spatula so the tip of the probe is in the center of the liquid.

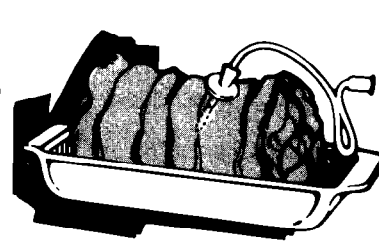

For roasts, the tip of the probe should be in the center of the largest muscle, but not touching fat or bone.

CHANGING OR CANCELLING INSTRUCTIONS

To change or cancel any instructions you have touched, simply touch CANCEL. All instructions will be cancelled. The Display will show the time of day and you can start over.

If you want to change or cancel instructions before you have touched START, simply touch in the new instructions. They will cancel the old ones.

OTHER OPERATING HINTS

These are a number of things you can do with your microwave oven. Some will be reminders. Others will be mentioned for the first time.

1. **To double check settings** while the oven is running, touch the command pad for the setting you want to check. The instruction programmed for that pad will show on the Display for 5 seconds. Then the Display returns to show what the oven is doing.
2. **To stop the oven while it is running:**
 - Open the door. The oven will stop. You can restart it by closing the door and touching START.
 - Touch CANCEL. All instructions will be erased. You must touch in new instructions.
3. If you touch two instructions into the **same** cycle, the second instructions will erase the first.
4. When using a Cook Power other than high, the Display will show the Cook Power for 2 seconds of every 10 during cooking.
5. When Cook Cycle 1 follows Defrost, a holding time equal to the Defrost time will occur before Cook Cycle 1. Cook Cycle 1 will begin after this automatic hold time.

CLEANING THE MICROWAVE OVEN



Wipe often with warm sudsy water and a soft cloth or sponge. The control panel may be cleaned with a soft soapy cloth or spray glass cleaner.

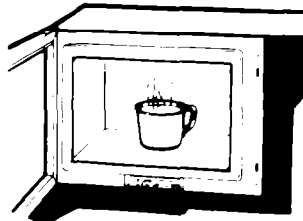

For stubborn soil, boil a cup of water in the oven for 2 or 3 minutes. Steam will soften the soil.

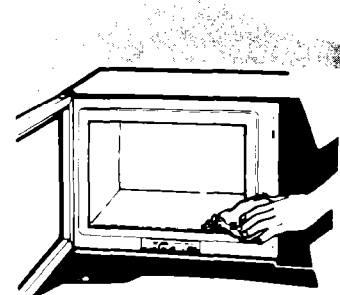

Be sure to clean the areas where the door and oven frame touch when closed. Rinse well.

Do not use abrasive cleaners or steel wool pads.

CLEANING THE PROBE:

1. Remove probe from microwave oven using hot pads.
2. Wipe probe with a hot sudsy cloth. Use a plastic scouring pad to remove stubborn foods.
3. Probe may be placed in the silverware basket of the dishwasher.
4. Be careful not to kink the cable.

NOTE: Make sure you have the right probe for your oven. It will have "HI-Z" on the handle.

IMPORTANT INFORMATION

Before you start using your microwave oven, read this section carefully. *This information will help you avoid damage to your oven.*

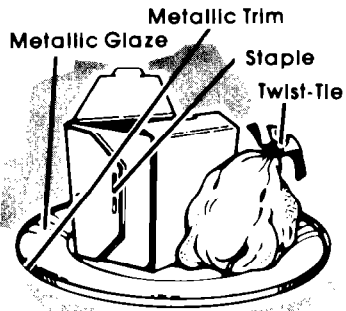

Cooking in metal containers can damage the oven. So can containers with **hidden metal** (twist-ties, foil-lining, staples, metallic glaze or trim). *Test dinnerware or cookware before using.*

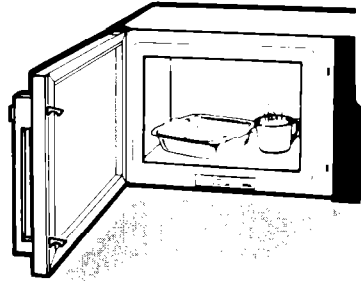

*To test a dish for safe use, put it into the oven with a cup of water **beside** it. Cook on high Cook Power for one minute. **If the dish gets hot and the water stays cool, do not use it.***



NEVER COOK OR REHEAT A WHOLE EGG. Slice hard boiled eggs before heating. Steam build-up in whole eggs may cause them to burst and possibly damage the oven.

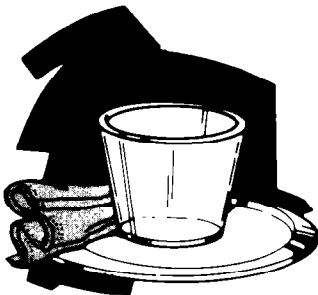

Paper can char or burn, and some plastics can melt if used when heating foods for more than 4 minutes.

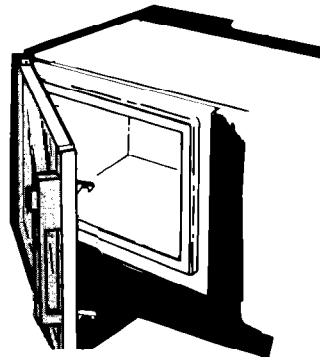

NEVER start a microwave oven when it's empty. The oven can be damaged. If you experiment, put a container of water in the oven.

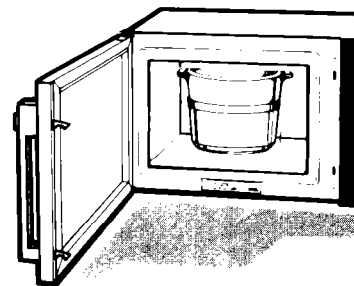

Don't let anything touch the top of the oven cavity.

Continued next page



Rough or harsh cleaners can scratch or dull the oven finish. **DO NOT USE THEM.**

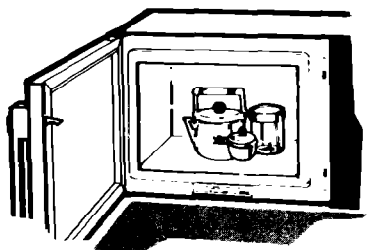

DO NOT store things in the oven.



Overcooking some foods can cause them to scorch or flame...especially foods like potatoes, popcorn, snacks, etc. See the **MICRO MENUS*** Cookbook.

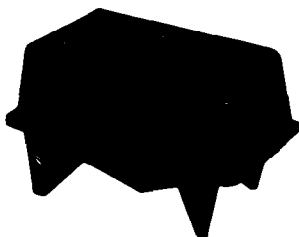

Make popcorn only in poppers designed for use in microwave ovens. Follow popper directions. Results are the popper manufacturer's responsibility.

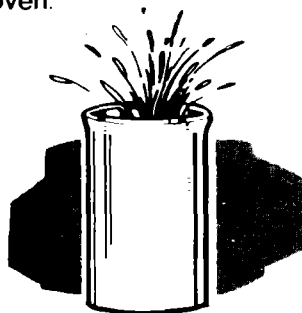

Liquids heated in certain containers may overheat. The liquid may then splash out with a loud noise. This does not harm the oven, but you should not use such containers to heat liquids again.



DO NOT OVERCOOK POTATOES. At the end of the recommended cooking time they should be slightly firm. Wrap in foil and set aside for 5 minutes. They will finish cooking while standing.

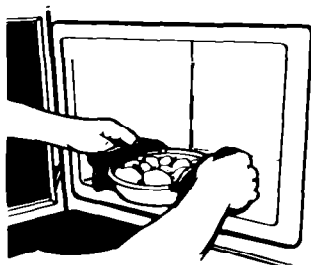

USE HOT PADS. Microwave energy does not heat containers, but the hot food does.



Follow **MICRO MENUS*** Cookbook directions carefully to properly cook different types of food. If using a different cookbook, you may need to experiment with times and Cook Powers.

- Double-check all settings.
- Use the oven only for defrosting, cooking or reheating.

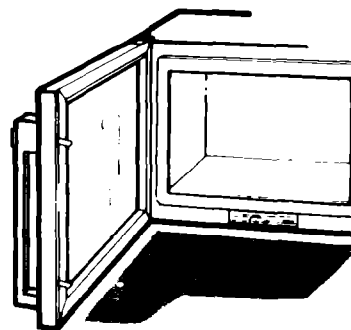

It is normal for the inside of the oven door to look wavy after the oven has been running for a while.



If your electric power line voltage is less than the normal 240 volts, cooking times may be longer.

At times, an extra fan automatically turns on to help protect the microwave oven from excess heat; you may notice a louder sound level when this fan is running.

HOW MICROWAVE OVENS WORK

Microwave ovens are safe. Microwave energy is not hot. It causes food to make its own heat, and it's this heat that cooks the food.

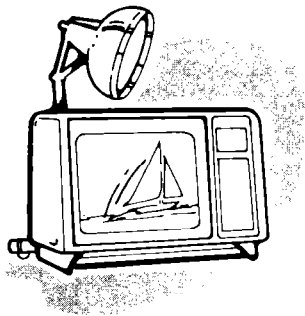

Microwaves are like TV waves or light waves. You can't see them, but you can see what they do.

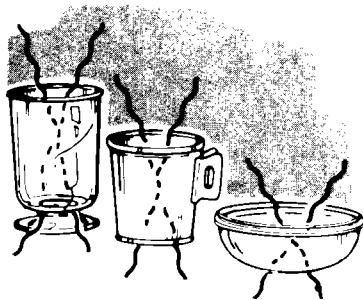

Microwaves pass through glass, paper and plastic without heating them so food absorbs the energy. Microwaves bounce off metal pans so food does not absorb the

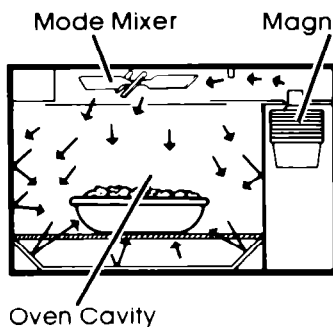

Oven Cavity

A magnetron produces microwaves. The microwaves move into the oven where they are scattered around by a stirrer (like a fan). Microwaves bounce off metal oven walls and are absorbed by food.

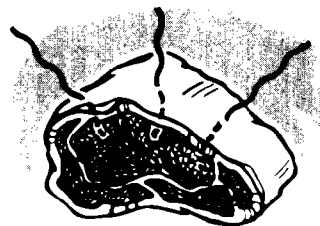

Microwaves may not reach the center of a roast. The heat around the outside is what cooks the roast all the way through. This is one of the reasons for letting some foods (roasts, baked potatoes) stand for a while after

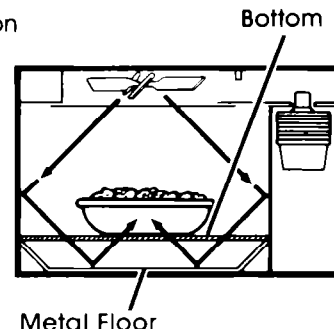

Metal Floor

The bottom of your microwave oven lets microwaves through. Then they bounce off the metal floor, back through the bottom, and are absorbed by the food.



The microwaves disturb water molecules in the food. As the molecules bounce around bumping into each

Using your lower oven

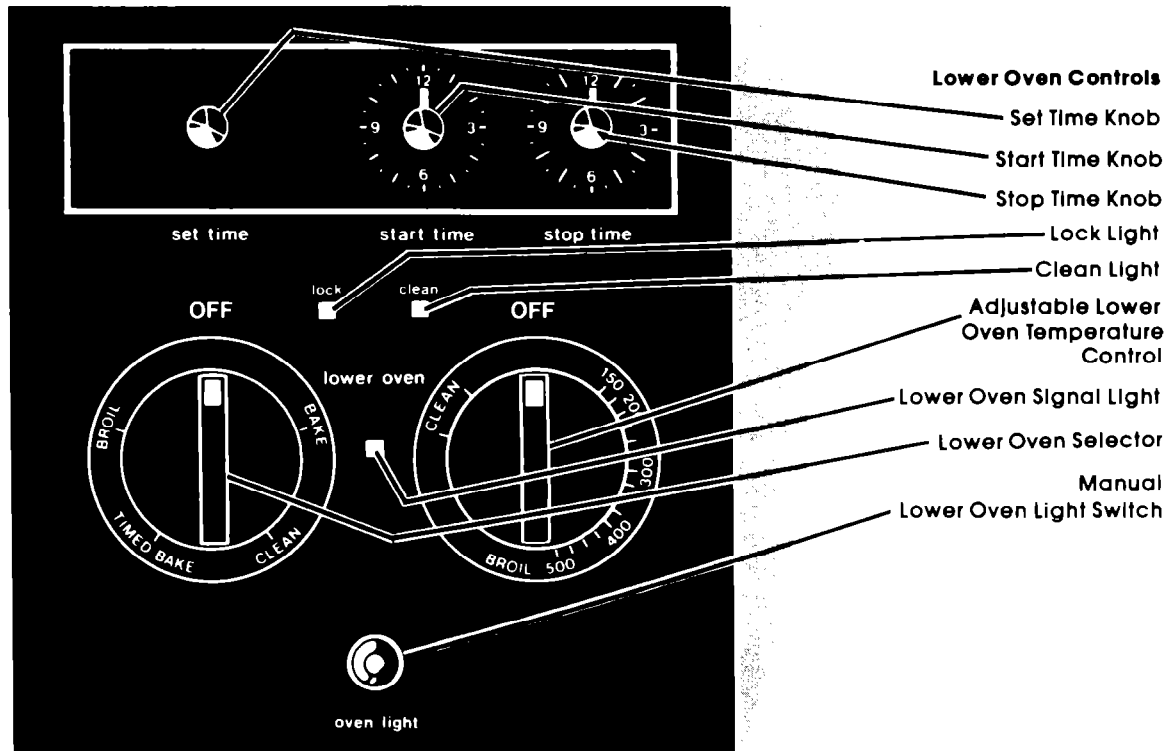

THE LOWER OVEN CONTROLS

The lower oven is controlled by two knobs: the Oven Selector and the Oven Temperature Control. *Both must be on a setting for the oven to heat.*

THE OVEN SELECTOR

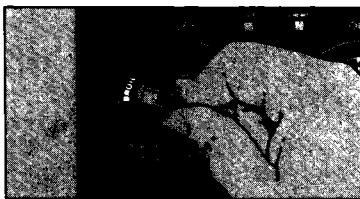

With the Oven Selector on BROIL, only the top element heats. (Broiling, pg. 25).



With the Oven Selector on BAKE, the bottom element does most of the work. The top element heats, but does not turn red. (Baking, pg. 23).



With the Oven Selector on TIMED BAKE, the MEALTIMER Clock can be used to turn the oven on and off automatically. (MEALTIMER Clock, pg. 24).

THE OVEN TEMPERATURE CONTROL

Use the Oven Temperature Control to set baking or roasting temperature when the Oven Selector is on BAKE or TIMED BAKE.

When both the Oven Selector and Temperature Control are on BROIL, the broil element heats all the time. The

Oven Temperature Control can be set on a temperature for slower broiling (see Broiling, page 25).

BAKING OR ROASTING

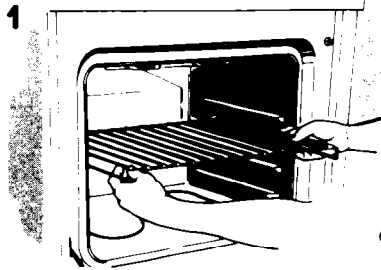

Lift rack at front and pull out.

Put the rack(s) where you want them before turning on the oven. Rack(s) should be placed so food can be centered in the oven. Always leave at least 1 1/2 to 2 inches (4-5 cm) between the sides of the pan and the oven walls and pans. For more information, see the "Cooking Guide."

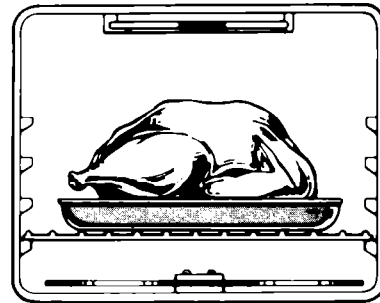

Set the Oven Selector on BAKE.

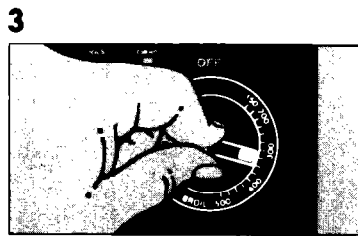

Set the Oven Temperature Control to the baking temperature you want.

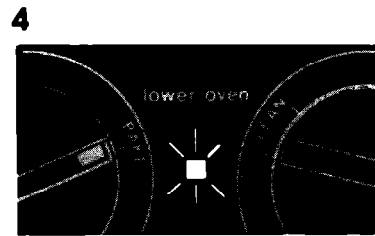

Let the oven preheat until the Signal Light goes off.

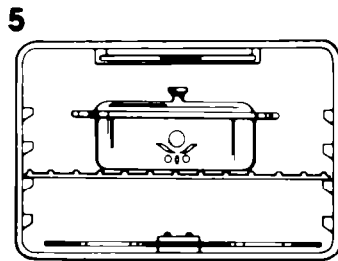

Put food in the oven. Oven rack, walls and door will be hot.

During baking, the elements will turn on and off to help keep the oven temperature at the setting. The Signal Light will turn on and off with the elements. The top element helps heat during baking, but does not turn red.

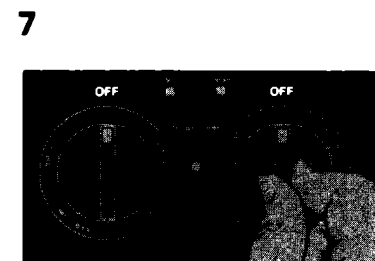

When baking is done, turn both knobs to OFF.

ADJUSTING THE OVEN TEMPERATURE CONTROL

Does your new oven seem to be hotter or colder at the same settings than your old oven? The temperature setting in your old oven may have changed gradually over the years. The accurate setting of your new oven can seem different. If you think the oven temperature needs adjusting, follow these steps:



1. Pull out the center of the Oven Temperature Control.

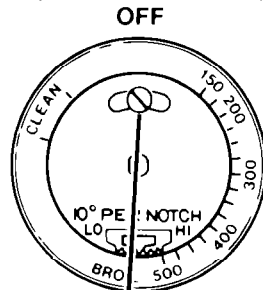

2. Loosen the locking screw.

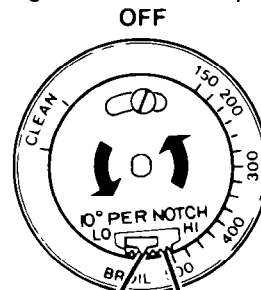

3. To lower the temperature, move black ring so tooth is closer to LO. Each notch equals about 10°F (5°C).

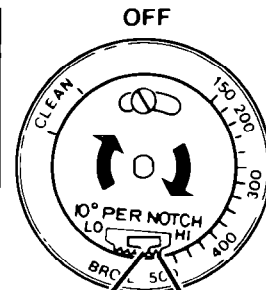

4. To raise the temperature, move black ring so tooth is closer to HI. Each notch equals about 10°F (5°C).

Tighten the locking screw. Replace the knob.

USING THE AUTOMATIC MEALTIMER® CLOCK

The Automatic MEALTIMER Clock is designed to turn the **lower oven** on and off at times you set...even when you are not around.

To start and stop baking automatically:

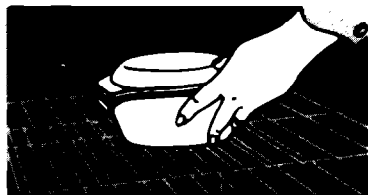

1. Put the lower oven rack(s) where you want them and place the food in the oven.



2. Turn the Set Time Knob until the Start and Stop Time Dials show the right time of day.

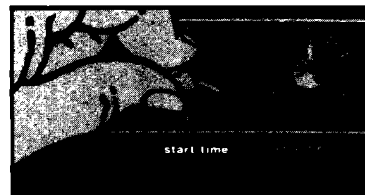

3. Push in and turn the Start Time Knob **clockwise** to the time you want baking to start.



4. Push in and turn the Stop Time Knob **clockwise** to the time you want the oven to shut off.

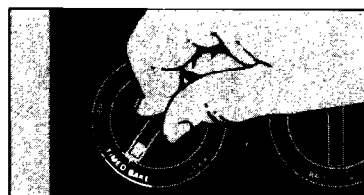

5. Set the Oven Selector on **TIMED BAKE**.

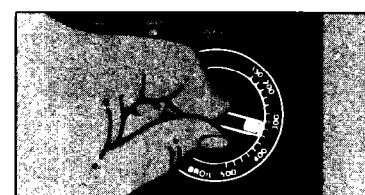

6. Set the Oven Temperature Control on the baking temperature you want.

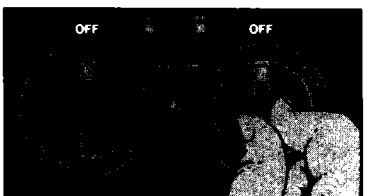

7. After baking is done, turn both knobs to **OFF**.

8. To stop the oven before the preset time, turn both knobs to **OFF**.

To stop baking automatically:

1. Put the oven rack(s) where you want them and place the food in the oven.
2. Turn the Set Time Knob until the Start and Stop Time Dials show the right time of day.
3. Push in and turn the Stop Time Knob **clockwise** to the time you want the oven to shut off.

4. Set the Oven Selector on **TIMED BAKE**.
5. Set the Oven Temperature Control on the baking temperature you want.
6. After baking is done, turn both knobs to **OFF**. To stop the oven before the preset time, turn both knobs to **OFF**.

SPECIAL CAUTION:

Use foods that will not go bad or spoil while waiting for cooking to start. Avoid using dishes with milk or eggs, cream soups, cooked meats or fish, or any item with baking powder or yeast.

Smoked or frozen meats may be used; so can vegetables, fruits and casserole-type foods. Vegetables can be cooked in

a covered baking dish with about a half-cup (118 mL) of water for 1 to 1½ hours.

Any food that has to wait for cooking to start should be very cold or frozen before it is put in the oven. **MOST UNFROZEN FOODS SHOULD NEVER STAND MORE THAN TWO HOURS BEFORE COOKING STARTS.**

BROILING

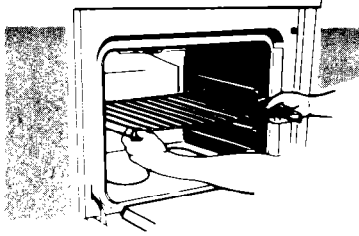

1. Place the rack where you want it for broiling.

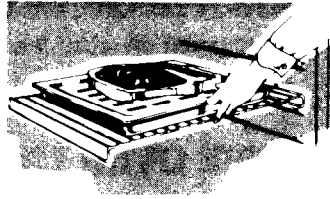

2. Put the broiler pan and food on the rack.

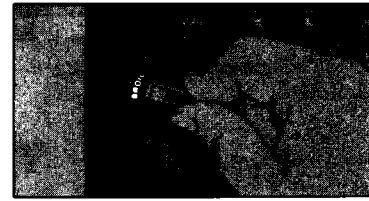

3. Set the Oven Selector on BROIL.

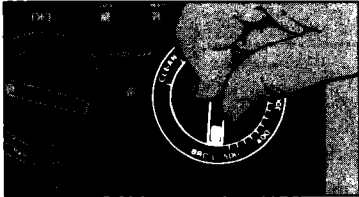

4. Set the Oven Temperature Control on BROIL (or on a lower temperature for slower broiling).

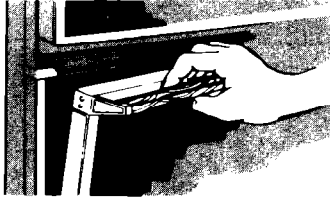

5. During broiling, the oven door must be partly open. A built-in stop will hold it there.



6. When broiling is done, turn both knobs to OFF.

For slower broiling, set the Oven Temperature Control on a temperature instead of BROIL. The broil element will then turn on and off instead of staying on. The lower the temperature setting, the slower the broiling.

The Oven Selector must be on BROIL and the door partly open for all broiling temperatures.

Suggested oven-rack positions and broiling times



Food	Description	inches (cm) from top of food to Broil Element	Approximate Minutes – Temperature set to BROIL	
			1st side	2nd side
Beef Steaks				
Rare	1" (2.5 cm)	3" (8 cm)	7-9	3-5
Medium	1" (2.5 cm)	3" (8 cm)	9-11	4-7
Well done	1" (2.5 cm)	3" (8 cm)	11-13	5-7
Beef Steaks				
Rare	1 1/2" (4 cm)	4"-5" (10-13 cm)	13-15	6-8
Medium	1 1/2" (4 cm)	4"-5" (10-13 cm)	17-19	8-10
Well Done	1 1/2" (4 cm)	4"-5" (10-13 cm)	19-21	14-16
Hamburgers	1/2" (1 cm)	3" (8 cm)	6-8	4-5
Lamb Chops				
Medium	1" (2.5 cm)	3" (8 cm)	6-8	4-5
Ham slice, precooked or tendered	1/2"-1" (1-2.5 cm)	3" (8 cm)	6-8	4-5
Canadian Bacon	1/2" (1 cm)	3" (8 cm)	6	4
Pork Rib or Loin Chop				
Well done	3/4"-1" (2-2.5 cm)	4"-5" (10-13 cm)	15	10
Chicken	2-3 lb. (1-1.5 kg) cut in half	7"-9" (18-23 cm)	25-30	10-12
Fish				
whole		3" (8 cm)	11-16	9-14
fillets		3" (8 cm)	7-8	5-7
Liver	1/2"-3/4" (1-2 cm)	3" (8 cm)	3	3
Frankfurters		4"-5" (10-13 cm)	6-7	4-5

The lights

THE MICROWAVE OVEN LIGHT

The light in the microwave oven comes on when the door is open and when the oven is operating.

THE LOWER OVEN LIGHT

The lower oven light will come on when you open the oven door or when you push the **Oven Light** switch at the bottom of the control panel. Close the oven door or push the switch again to shut it off.

To replace the light bulb:

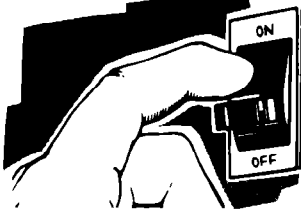

1. Turn off the electric power at the main power supply.

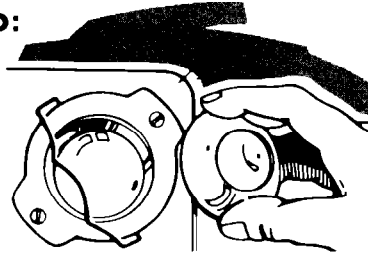

2. Remove the bulb cover by pulling out on the wire holder and moving it to the side.

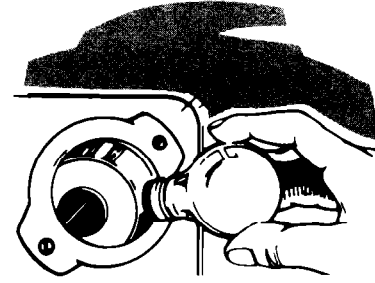

3. Remove the light bulb from its socket.

4. Replace the bulb with a 40-watt **appliance** bulb available from most grocery, variety and hardware stores.

5. Replace the bulb cover and snap the wire holder in place. **The bulb must have this cover when the oven is being used.**

6. Turn the power back on at the main power supply.

The oven vent

Hot air and moisture get out of the lower oven through a vent just above the oven door.

Do not block the vent. Poor baking can result.

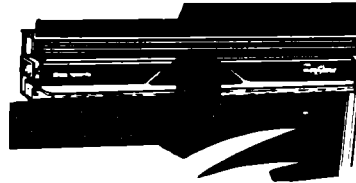

Cleaning and caring for your oven

CONTROL PANEL AND KNOBS

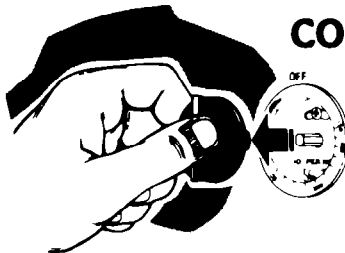

1. First make sure knobs are on **OFF** then pull knob straight off.



2. Use warm soapy water and a soft cloth to wipe the panel. Rinse and wipe dry.



3. Wash knobs in warm soapy water. Rinse well and dry.

4. Push knobs straight back on. Make sure they are on **OFF**.

THE LOWER OVEN SELF-CLEANING CYCLE

The lower oven self-cleaning cycle uses **very high heat** to burn away soil. Before you start, make sure you understand exactly how to use the cycle safely.

BEFORE YOU START

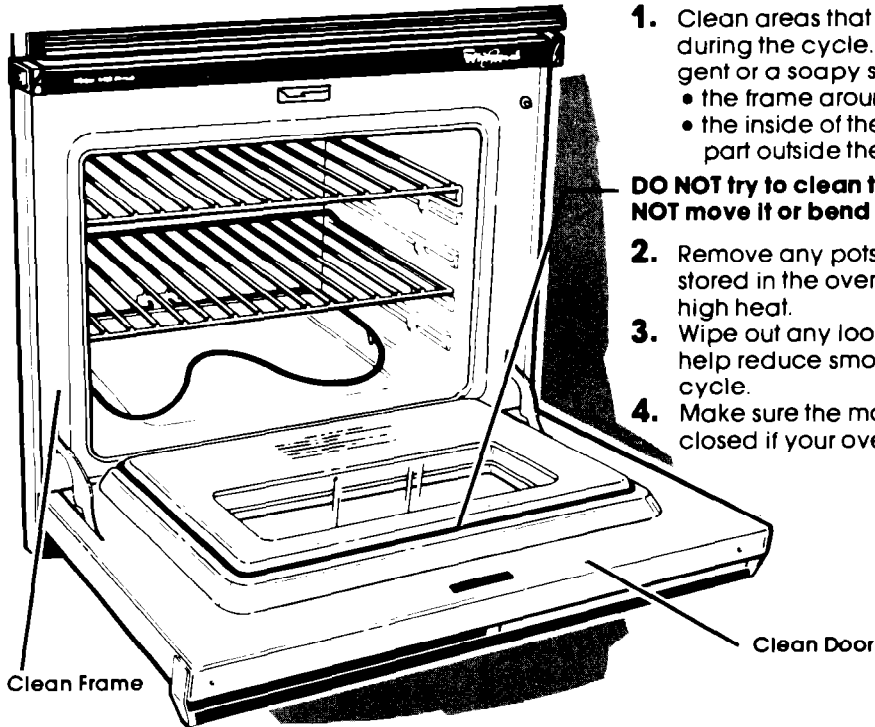

1. Clean areas that may not be cleaned during the cycle. Use hot water and detergent or a soapy steel-wool pad on...
 - the frame around the oven
 - the inside of the door, especially the part outside the oven seal.
- DO NOT** try to clean the fiberglass seal. **DO NOT** move it or bend it.
2. Remove any pots or pans you may have stored in the oven. They can't stand the high heat.
 3. Wipe out any loose soil or grease. This will help reduce smoke during the cleaning cycle.
 4. Make sure the motor socket cover is closed if your oven has a rotisserie.

SPECIAL CAUTIONS

DO NOT block the vent during the cleaning cycle. Air must move freely for best results.

DO NOT touch the oven during the cleaning cycle...it can burn you.

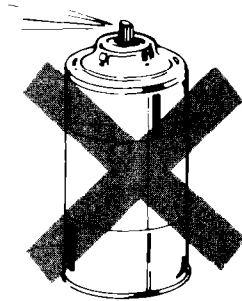

DO NOT use commercial oven cleaners in your oven. Damage to the porcelain finish may occur.

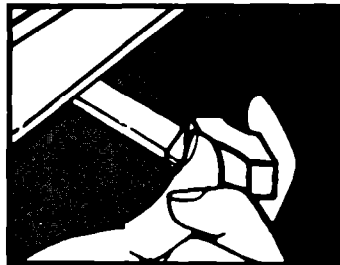

DO NOT force the Lock Lever. The lever is designed to stay locked until the oven is cool enough to safely open.

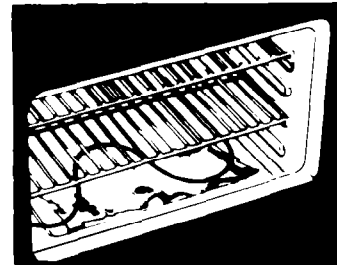

DO NOT use foil or other liners in the oven. During the cleaning cycle, foil can burn or melt.

SETTING THE CONTROLS



1. Set the Oven Selector to CLEAN.

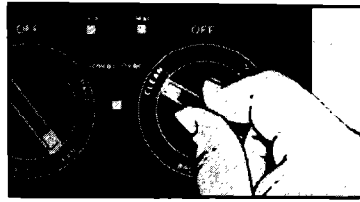

2. Set the Oven Temperature Control to CLEAN.

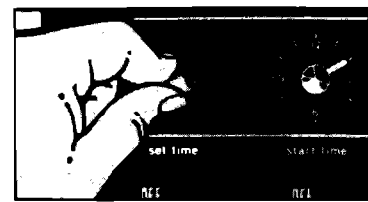

3. Turn the Set Time Knob until the Start and Stop Time Dials show the right time of day.



4. Push in the Stop Time Knob and turn the hand clockwise about two or three hours. (Two hours for light soil; three or more for heavier soil.)

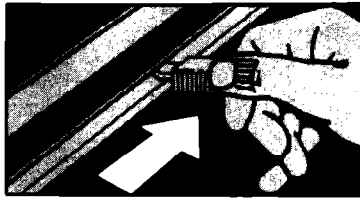

5. Lift the Lock Lever Cover Panel and move the Lock Lever *all the way to the right*. The Clean Light will come on only when the lever is all the way over.

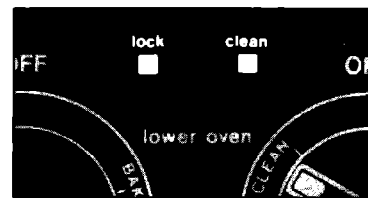

6. The Lock Light comes on when the oven gets above normal baking temperatures. The Lock Lever can't be moved when the Lock Light is on.

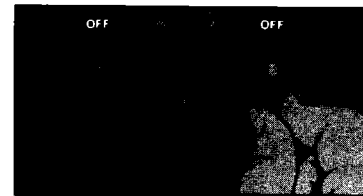

7. When the Lock Light goes off, turn the Oven Selector and Oven Temperature Control to OFF.

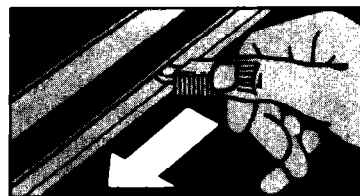

8. Move the Lock Lever back to the left. **Do not force it.** Wait until it will move easily. This turns off the Clean Light.



9. **After the oven is cool,** wipe off any residue or ash with a damp cloth. If needed, touch up spots with cleanser or soapy steel-wool pad.

DO NOT TOUCH THE OVEN DURING THE CLEANING CYCLE. IT CAN BURN YOU.

SPECIAL TIPS

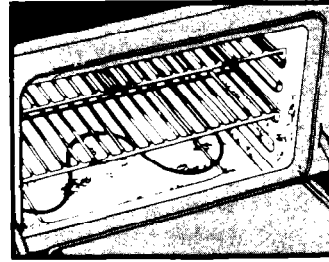
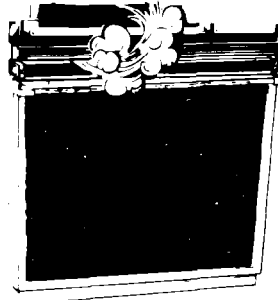
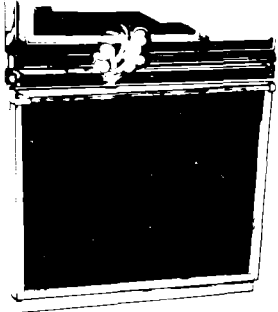

1. Keep the kitchen well ventilated during the cleaning cycle to help get rid of normal heat odors and smoke
2. Clean the oven before it gets heavily soiled. Cleaning a very soiled oven takes longer and results in more smoke than usual
3. If the cleaning cycle doesn't get the oven as clean as you expected, the cycle may not have been set long enough. Set the cleaning time longer for heavier soil.
4. Oven racks lose their shine, discolor and become harder to slide on their guides when they are left in the oven during the cleaning cycle. To make them slide easier, polish the edges of the racks and rack guides with a soapy steel-wool pad, rinse well, and wipe on a thin coat of salad oil.
5. To stop the cleaning cycle after it has started:
 - Turn the Stop Time Knob clockwise until the hand points to the right time of day.
 - Turn the Oven Selector and Oven Temperature Control to OFF.
 - When the oven cools, move the Lock Lever back to the left. DO NOT FORCE IT. Wait until it moves easily.

HOW IT WORKS

During the self-cleaning cycle, the oven gets much hotter than it does for baking or broiling...approximately 875° F (468° C). This heat breaks up grease and soil, and burns it off.

The graph shows approximate temperatures and times during a self-cleaning cycle set for two hours.

SELF-CLEANING CYCLE – TWO HOUR SETTING

(Approximate Temperatures and Times)

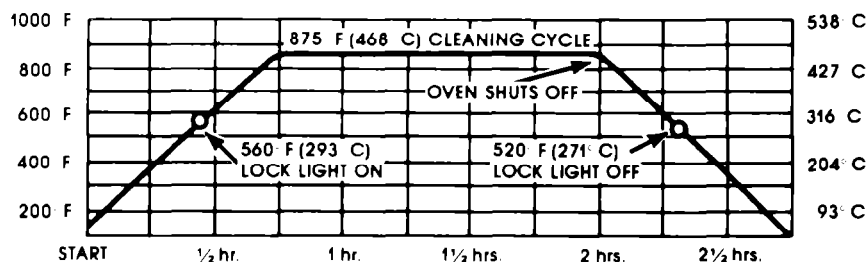

Notice that the heating stops when the two-hour setting is up, but that it takes a while longer for the oven to cool down enough to unlock.

CLEANING CHART

PART	WHAT TO USE	HOW TO CLEAN
Aluminum broiler pan and grid	Warm, soapy water or soapy steel wool pads	<ul style="list-style-type: none"> • Wash with other cooking utensils. • Do not place in Self-Cleaning Oven.
Control knobs	Warm, sudsy water and bristle brush	<ul style="list-style-type: none"> • Wash, rinse and dry well. • Do not soak.
Control panel	Warm, soapy water Commercial glass cleaner	<ul style="list-style-type: none"> • Wash, rinse and dry with soft cloth. • Follow directions with cleaner.
Oven racks	Self-Cleaning Oven cycle Warm, soapy water or soapy steel wool pads	<ul style="list-style-type: none"> • Leave in oven during Self-Cleaning cycle. • Wash, rinse and dry. Use soapy steel wool pads for stubborn areas.
Lower oven door glass and outside only of microwave oven	Warm, soapy water or plastic scrubbing pad Commercial glass cleaner	<ul style="list-style-type: none"> • Make certain oven is cool. Wash, rinse and dry well with soft cloth. • Follow directions provided with cleaner.
Self-Cleaning Oven	For areas outside Self-Cleaning area use warm, soapy water or soapy steel wool pads	<ul style="list-style-type: none"> • Clean before using Self-Cleaning cycle to prevent burn-on of soil. • Follow directions given on page 27. "The Lower Oven Self-Cleaning Cycle." • Do not use commercial oven cleaners.

Do not use foil to line the bottom of your Self-Cleaning Oven.

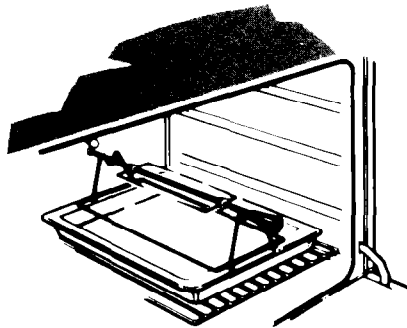

THE OPTIONAL ROTISSERIE

If you would like a rotisserie for your lower oven, you can order a kit (Part No. 261881) from your dealer. The kit includes easy installation instructions.

If you need service or assistance, we suggest you follow these four steps:

1. Before calling for assistance...

Performance problems often result from little things you can find and fix yourself without tools of any kind.

If nothing operates:

- Is the oven correctly wired to a live circuit with the proper voltage? (See **Installation Instructions**.)
- Have you checked the main fuse or circuit breaker box?

If the microwave oven will not run:

- Is the timer set?
- Is the door firmly closed and latched?
- Did you touch START?
- Did you follow the directions **exactly**?

If microwave cooking times seem too long:

- Is the electric supply to your home low or lower than normal? Your electric company can tell you if the line voltage is low.
- Is the Cook Power at the recommended setting?
- Are you allowing for more time when cooking more food at one time?

If the display shows a time counting down but the oven is not cooking:

- Is the Hold Indicator light on?
- Is the Minute Timer and no Cook Cycle indicator light on?
- Is the oven door closed completely?

If the microwave oven turns off too soon or not soon enough when using the probe:

- Is at least $\frac{1}{3}$ of the probe in the food?
- Is the probe tip in the center of the food?
- Is the probe touching bone or fat?
- Have you allowed roasts to stand for a few minutes after cooking?

- Is the probe plugged tightly into its socket?
- Is the Cook Power set where it should be?
- Is the Temperature Probe Control [(Cook Temp)] set at the end temperature you want?

If the lower oven will not operate:

- Is the Oven Selector turned to a setting (BAKE or BROIL, but not TIMED BAKE)?
- Is the Oven Temperature Control turned to a temperature setting?

If the Self-Cleaning cycle will not operate:

- Are the Oven Selector and the Oven Temperature Control set to "CLEAN?"
- Does the Start Time Dial show the correct time of day?
- Is the Stop Time Dial set ahead to the time you want the cleaning cycle to stop?
- Is the Lock Lever all the way to the right? (The Clean Light will come on.)

If cooking results aren't what you expect:

- Is the oven level?
- Are you using pans recommended in the **Cooking Guide**?
- If baking, have you allowed 1½ to 2 inches (4-5 cm) on all sides of the pans for air circulation?
- Does the oven temperature seem too low or too high? See page 23, "Adjusting the oven temperature control."
- Have you preheated the oven as the recipe calls for?
- Are the pans the size called for in the recipe?
- Are you following a tested recipe from a reliable source?

See the **Cooking Guide** for more information on cooking problems and how to solve them.

2. If you need assistance* ...

Call the Whirlpool COOL-LINE® service assistance telephone number. Dial free from:
Continental U.S. (800) 253-1301
Michigan (800) 632-2243
Alaska & Hawaii (800) 253-1121

and talk with one of our trained Consultants. The Consultant can instruct you in how to obtain satisfactory operation from your appliance or, if service is necessary, recommend a qualified service company in your area.



FSP is a registered trademark of Whirlpool Corporation for quality parts. Look for this symbol of quality whenever you need a replacement part for your Whirlpool appliance. FSP replacement parts

will fit right and work right, because they are made to the same exacting specifications used to build every new Whirlpool appliance.

3. If you need service* ...



Whirlpool has a nationwide network of franchised TECH-CARE® Service Companies. TECH-CARE service technicians are trained to fulfill the product warranty and provide after-

warranty service, anywhere in the United States. To locate TECH-CARE service in your area, call our COOL-LINE service assistance telephone number (see Step 2) or look in your telephone directory Yellow Pages under:

**APPLIANCES—HOUSEHOLD—
MAJOR—SERVICE & REPAIR**

WHIRLPOOL APPLIANCES
FRANCHISED TECH-CARE SERVICE

SERVICE COMPANIES
XYZ SERVICE CO
123 Maple

**ELECTRICAL APPLIANCES—
MAJOR—REPAIRING & PARTS**

WHIRLPOOL APPLIANCES
FRANCHISED TECH CARE SERVICE

SERVICE COMPANIES
XYZ SERVICE CO
123 Maple

OR

OR

**WASHING MACHINES, DRYERS
& IRONERS—SERVICING**

WHIRLPOOL APPLIANCES
FRANCHISED TECH-CARE SERVICE

SERVICE COMPANIES
XYZ SERVICE CO
123 Maple

4. If you have a problem* ...

Call our COOL-LINE service assistance telephone number (see Step 2) and talk with one of our Consultants, or if you prefer, write to:

Mr. Guy Turner, Vice President
Whirlpool Corporation
Administrative Center
2000 US-33 North
Benton Harbor, MI 49022

If you must call or write, please provide: model number, serial number, date of purchase, and a complete description of the problem. This information is needed in order to better respond to your request for assistance.



Benton Harbor, Michigan. Automatic Washers, Clothes Dryers, Freezers, Refrigerator-Freezers, Ice Makers, Dishwashers, Built-in Ovens and Surface Units, Ranges, Microwave Ovens, Compactors, Room Air Conditioners, Dehumidifiers, Central Heating and Air Conditioning Systems.