

RANGE HOOD

| | | |
|----------------------|-----------------|------------|
| Model Number: | JXT8136ADS | JXT8142ADS |
| Manufacturer Number: | S98M90S | S98E42S |
| Size: | 35-3/8" (90 cm) | 42" |

USER GUIDE

TABLE OF CONTENTS

| | |
|--------------------------|-----|
| Safety Instructions..... | 1 |
| Controls & Features..... | 2-4 |
| Maintenance..... | 5-6 |
| Warranty..... | 7 |



USE AND CARE GUIDE

Read all Instructions before Installing and operating this appliance

MODEL: JXT8136ADS JXT8142ADS

IMPORTANT SAFETY NOTICE



WARNING

Installation

The installation in this manual is intended for qualified installers, service technicians or persons with similar qualified background. DO NOT attempt to install this appliance yourself. Injury could result from installing the unit due to lack of appropriate electrical and technical background.

All electrical wiring must be properly installed, insulated and grounded. Overly accumulated grease in old duct work should be cleaned out or duct work should be replaced if necessary to avoid the possibility of a grease fire. Check all joints on duct work to insure proper connection and all joints should be properly taped.

Operations

Read all instructions in this manual before operating the appliance. Save these instructions for future reference.

Always leave safety grills and filters in place. Without these components, operating blowers could catch on to hair, fingers and loose clothing.

NEVER dispose cigarette ashes, ignitable substances, or any foreign objects into blowers.

NEVER leave cooking unattended. When frying, oil in the pan can easily overheat and catch fire. The risk of self combustion is higher when the oil has been used several times.

Cleaning

The saturation of greasy residue in the blower and filters may cause increased flammability. Keep unit clean and free of grease and residue build-up at all times to prevent possible fires.

Filters must be cleaned periodically and kept free from accumulation of cooking residue (see cleaning instructions inside). Old and worn filters must be replaced immediately. Do not operate blowers when filters are removed. Never disassemble parts to clean without proper instructions. Disassembly is recommended to be performed by qualified personnel only. Call our service center for removal instructions. 1-800-JENNAIR (1-800-536-6247)

The manufacturer declines all responsibility in the event of failure to observe the instructions given here for installation, maintenance and suitable use of the product. The manufacturer further declines all responsibility for injury due to negligence and the warranty of the unit automatically expires due to improper maintenance.

** Please check for latest specification revisions before any custom work or cutouts.*

CONTROLS & FEATURES

2

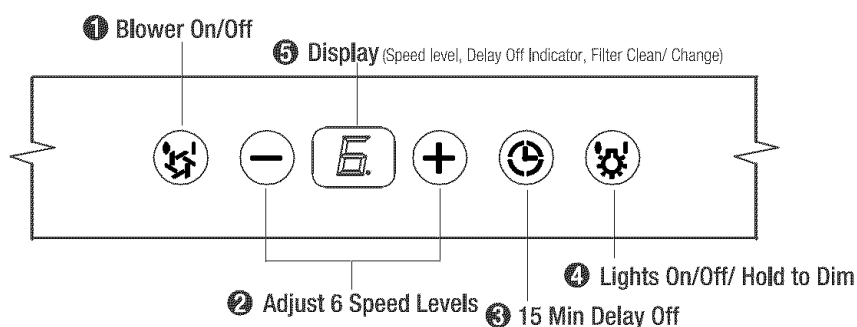

TOUCH CONTROLS & FEATURES





❶ Blower On/Off

By pressing , the blower is switched On and Off. When switched on, the blower starts up on speed level 3.



❷ Speed Selection

The 6 speed levels are selected by pressing  to decrease and  to increase speed level. The display indicates level selected.

❸ Delay Off

This is used for programmed shut down of blower and lights 15 minutes after the function is activated. Press  once, a dot flashes in the lower right hand side of display  indicating the function is on. The hood will completely shut down in 15 minutes.

❹ Lights On/Off/ Dim

Switch lights On and Off by pressing key  once. To dim lights, press and hold  for 2 seconds.

❺ Advance Display Functions

Filter Clean Reminder (Metal):

After every 30 hours of use, the display will start flashing an  reminding you to clean the metal filters for residue and possible clogs.



The standard Metal Filters are required to be cleaned frequently and as recommended in order to maintain blower efficiency. If improperly maintained, residue from cooking will sift through filters and cause damage to hood blowers and other sensitive components; and possibly clog duct work and create a fire hazard.

CONTROLS: FILTER CHANGE INDICATOR (CARBON FILTERS)

Filter Change Reminder (Carbon, if fitted):

When your hood is installed as a 'Purifying' (Ductless Recirculating) unit, it is fitted with a set of Carbon Filters to purify exhaust and fumes from cooking, then re-circulate the air within the home. These Carbon Filters are required to be replaced after every 120 hours of use. The **Filter Change Reminder** function in the microprocessor needs to be switched on. The microprocessor in the controls when set, will elapse and count usage time and indicate by a flashing  when carbon filter replacement is needed.

Setting the Filter Change Reminder:

When Off, hold  for approx. 5 seconds. The display will change from  (exhaust mode) to , (purifying mode/ carbon filters used) this indicates that the elapse timer function is switched on and Carbon Filters are used.

Set Mode

hold 5 secs.



display from <--> to <C>



Filter Replace Indicator:



When the display  starts flashing, the Carbon Filters require replacement.

Change Filters

display <C> flashes



Re-setting Function:

Once filters are replaced, with hood off, press and hold , the display will appear; hold for approximately 5 seconds until  on display disappears . The Filter Change Reminder is now re-set and a new 120 hours elapse cycle is initiated.

To Reset

hold 5 secs.



display from <C> to < >



CONTROLS: FILTER CLEAN INDICATOR (METAL FILTERS)

Filter Clean Reminder (Standard Metal Filters fitted)

Whether your hood is installed as an Exhaust or Purifying unit, a set of metal filters are fitted by the factory. These Metal Filters are intended to filter out residue from cooking. They need not be replaced on a regular basis but are required to be kept clean. The **Filter Change Reminder** function in the microprocessor will automatically indicate by a flashing  when the metal filters need to be cleaned after every 30 hrs. of use. Filters can be cleaned by hand with non-abrasive soap or in a dishwasher. Heavily soiled filters should also be soaked in grease cutting detergent such as Formula '409' or its equivalent, prior to cleaning.

Filter Clean Reminder:



When  flashes on display, the metal filters installed are required to be cleaned. This will occur after every 30 hours of use.

Clean Filters

display <A> flashes



Re-setting Function:

Reset the Filter Clean Reminder timer when filters are cleaned and re-installed. Press and hold  for approx. 5 seconds, the display will appear; hold for approximately 5 seconds until  on display disappears . The Filter Clean Reminder function is now re-set and a new 30 hours elapse cycle is initiated.

To Reset

hold 5 secs.



display from <C> to < >



CLEANING

Surface Maintenance:

Clean periodically with hot soapy water and clean cotton cloth. Do not use corrosive or abrasive detergent (e.g. Comet powder scrub, EZ-Off oven cleaner), or steel wool/scouring pads which will scratch and damage surface.

For heavier soil use liquid degreaser such as "Formula 409" or "Fantastic" brand cleaner.

After cleaning, you may use non-abrasive stainless steel polish/ cleaners such as 3M or ZEP, to polish and buff out the stainless luster and grain. Always scrub lightly, with clean cotton cloth, and with the grain. Do not use any product containing chlorine bleach. Do not use "orange" cleaners.

Metal Filters

The Metal Filters fitted by the factory are intended to filter out residue and grease from cooking. They need not be replaced on a regular basis but are required to be kept clean. Filters should be cleaned after every 30 hours of use. Use the Filter Clean Reminder function on the controls to determine when filters require cleaning.

Remove and clean by hand or in dishwasher. Spray 'Formula 409' or equivalent degreasing detergent and leave to soak if heavily soiled. Dry filters and re-install before using hood.

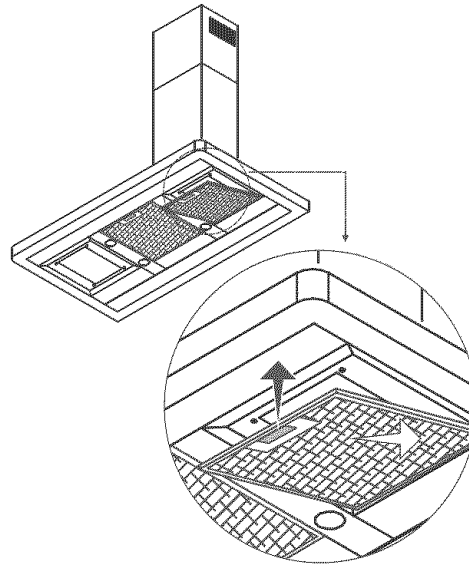

Replacing Metal Filters

Should filters wear out due to age and prolonged use, replace with following part number:

| Hood Model: | Part No. | Filters in pkg. |
|-------------|----------|-----------------|
| JXT8136ADS | 49001001 | 3 |
| JXT8142ADS | 49001001 | 3 |

Metal Filter Dimensions:

16.14 in x 9.17 in x 0.35 in
410 mm x 233 mm x 9 mm

Also replace any damaged filter that has punctured or broken mesh, bent or broken frame.

LIGHTS

Replacing Light Bulbs



CAUTION: Light bulb becomes extremely hot when turned on. **DO NOT** touch bulb until switched off and cooled. Touching hot bulbs could cause serious burns.

Make sure all power is turned off and bulbs are cool.

Remove by turning bulb counter clockwise.

If bulbs are difficult to turn due to prolonged use, firmly attach a glass suction cup approx. the diameter of the bulb and turn. Use a rubber gripper or rubber gloves to remove bulb.

Replacement bulbs are available at specialty lighting stores. Purchase type GU10 120V 50W halogen bulbs.

Or to order bulbs, please call our service center: **1-800-JENNAIR (1-800-536-6247)**

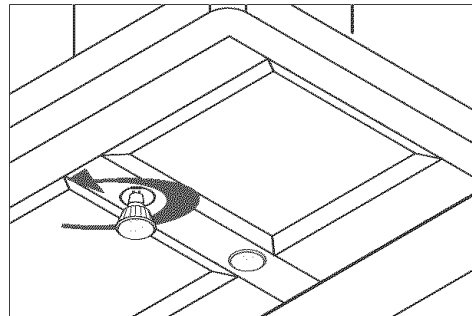

Warranty:**Full One Year Warranty - Parts and Labor**

For one (1) year from the original retail purchase date, any part which fails in normal home use will be repaired or replaced free of charge.

Limited Warranty - Parts Only

Second Year - After the first year from the original purchase date, parts which fail in normal home use will be repaired or replaced free of charge for the part itself, with the owner paying all other costs, including labor, mileage and transportation.

Canadian Residents

The above warranties only cover an appliance installed in Canada that has been certified or listed by appropriate test agencies for compliance to a National Standard of Canada unless the appliance was brought into Canada due to transfer of residence from the United States to Canada.

*The specific warranties expressed above are the **ONLY** warranties provided by the manufacturer. These warranties give you specific legal rights, and you may also have other rights which vary from state to state.*

What is Not Covered By These Warranties:

1. Conditions and damages resulting from any of the following:
 - a. Improper installation, delivery, or maintenance.
 - b. Any repair, modification, alteration, or adjustment not authorized by the manufacturer or an authorized servicer.
 - c. Misuse, abuse, accidents, or unreasonable use.
 - d. Incorrect electric current, voltage, or supply.
 - e. Improper setting of any control.
2. Warranties are void if the original serial numbers have been removed, altered, or cannot be readily determined.
3. Light bulbs.
4. Products purchased for commercial or industrial use.
5. The cost of service or service call to:
 - a. Correct installation errors.
 - b. Instruct the user on the proper use of the product.
 - c. Transport the appliance to the servicer.
6. Consequential or incidental damages sustained by any person as a result of any breach of these warranties. Some states do not allow the exclusion or limitation of consequential or incidental damages, so the above exclusion may not apply.

If You Need Service

- Call the dealer from whom your appliance was purchased or call Maytag ServicesSM, Jennair Customer Assistance at 1-800-JENNAIR (1-800-536-6247) USA and CANADA to locate an authorized servicer.
- Be sure to retain proof of purchase to verify warranty status. Refer to WARRANTY for further information on owner's responsibilities for warranty service.
- If the dealer or service company cannot resolve the problem, write to Maytag ServicesSM, Attn:CAIR® Center, P.O. Box 2370, Cleveland, TN 37320-2370, or call 1-800-JENNAIR (1-800-536-6247) USA and CANADA.

U.S. customers using TTY for deaf, hearing impaired or speech impaired, call 1-800-688-2080.

NOTE: When writing or calling about a service problem, please include the following information:

- a. Your name, address and telephone number;
 - b. Model number and serial number;
 - c. Name and address of your dealer or servicer;
 - d. A clear description of the problem you are having;
 - e. Proof of purchase (sales receipt)
- User's guides, service manuals and parts information are available from Maytag ServicesSM, Jennair Customer Assistance.