

MICROWAVE HOOD COMBINATION

Use & Care Guide

For questions about features, operation/performance
parts, accessories or service, call: **1-800-253-1301**.
or visit our website at...
www.whirlpool.com

Table of Contents 2

Model MH8150XM

TABLE OF CONTENTS

MICROWAVE OVEN SAFETY	3
Electrical Requirements	5
PARTS AND FEATURES	5
Turntable	5
Cooking Rack.....	6
MICROWAVE OVEN CONTROL	6
Display	6
Progress Bar.....	7
Number Codes.....	7
Start	7
JET START™ Feature	7
Cancel•Off.....	7
Clock	7
Tones.....	7
Timer.....	8
Child Lock	8
Vent Fan	8
Cooktop Light.....	8
Demo Mode.....	8
MICROWAVE OVEN USE	8
Food Characteristics	8
Cooking Guidelines	9
Cookware and Dinnerware	9
Aluminum Foil and Metal	9
Cooking Power.....	10
Cooking	10
Cooking in Stages.....	10
One Touch Cooking	11
Preset Cooking.....	11
Reheating	11
Defrosting	12
Warm Hold	12
MICROWAVE OVEN CARE	13
General Cleaning.....	13
Replacing Filters.....	13
Replacing Cooktop Light	14
Replacing Microwave Oven Light	14
TROUBLESHOOTING	14
ASSISTANCE OR SERVICE	15
Replacement Parts.....	15
WARRANTY	16



MICROWAVE OVEN SAFETY

Your safety and the safety of others are very important.

We have provided many important safety messages in this manual and on your appliance. Always read and obey all safety messages.



This is the safety alert symbol.

This symbol alerts you to potential hazards that can kill or hurt you and others.

All safety messages will follow the safety alert symbol and either the word "DANGER" or "WARNING." These words mean:

! DANGER

You can be killed or seriously injured if you don't immediately follow instructions.

! WARNING

You can be killed or seriously injured if you don't follow instructions.

All safety messages will tell you what the potential hazard is, tell you how to reduce the chance of injury, and tell you what can happen if the instructions are not followed.

IMPORTANT SAFETY INSTRUCTIONS

When using electrical appliances basic safety precautions should be followed, including the following:

WARNING: To reduce the risk of burns, electric shock, fire, injury to persons, or exposure to excessive microwave energy:

- Read all instructions before using the microwave oven.
- Read and follow the specific "PRECAUTIONS TO AVOID POSSIBLE EXPOSURE TO EXCESSIVE MICROWAVE ENERGY" found in this section.
- The microwave oven must be grounded. Connect only to properly grounded outlet. See "GROUNDING INSTRUCTIONS" found in this section and in the provided Installation Instructions.
- Install or locate the microwave oven only in accordance with the provided Installation Instructions.
- Some products such as whole eggs in the shell and sealed containers – for example, closed glass jars – may explode and should not be heated in the microwave oven.
- Use the microwave oven only for its intended use as described in this manual. Do not use corrosive chemicals or vapors in the microwave oven. This type of oven is specifically designed to heat, cook, or dry food. It is not designed for industrial or laboratory use.
- As with any appliance, close supervision is necessary when used by children.
- Do not operate the microwave oven if it has a damaged cord or plug, if it is not working properly, or if it has been damaged or dropped.
- The microwave oven should be serviced only by qualified service personnel. Call an authorized service company for examination, repair, or adjustment.
- See door surface cleaning instructions in the "Microwave Oven Care" section.
- To reduce the risk of fire in the oven cavity:
 - Do not overcook food. Carefully attend the microwave oven if paper, plastic, or other combustible materials are placed inside the oven to facilitate cooking.
 - Remove wire twist-ties from paper or plastic bags before placing bags in oven.
 - If materials inside the oven should ignite, keep oven door closed, turn oven off, and disconnect the power cord, or shut off power at the fuse or circuit breaker panel.
 - Do not use the cavity for storage purposes. Do not leave paper products, cooking utensils, or food in the cavity when not in use.

SAVE THESE INSTRUCTIONS

IMPORTANT SAFETY INSTRUCTIONS

- Suitable for use above both gas and electric cooking equipment.
- Intended to be used above ranges with maximum width of 36 inches.
- Clean Ventilating Hoods Frequently - Grease should not be allowed to accumulate on hood or filter.
- Oversized foods or oversized metal utensils should not be inserted in the microwave oven as they may create a fire or risk of electric shock.
- Do not clean with metal scouring pads. Pieces can burn off the pad and touch electrical parts involving a risk of electric shock.
- Do not use paper products when appliance is operated in the "PAN BROWN" mode (on models with this feature).
- Do not store any materials, other than manufacturer's recommended accessories, in this oven when not in use.
- Do not store anything directly on top of the microwave oven when the microwave oven is in operation.
- When flaming foods under the hood, turn the fan on.
- Use care when cleaning the vent-hood filter. Corrosive cleaning agents, such as lye-based oven cleaners, may damage the filter.
- Do not cover or block any openings on the microwave oven.
- Do not store this microwave oven outdoors. Do not use the microwave oven near water - for example, near a kitchen sink, in a wet basement, or near a swimming pool, and the like.
- Do not immerse cord or plug in water.
- Keep cord away from heated surfaces.
- Do not let cord hang over edge of table or counter.
- Do not mount over a sink.
- Do not cover racks or any other part of the oven with metal foil. This will cause overheating of the oven.

SAVE THESE INSTRUCTIONS

PRECAUTIONS TO AVOID POSSIBLE EXPOSURE TO EXCESSIVE MICROWAVE ENERGY

- (a) Do not attempt to operate this oven with the door open since open-door operation can result in harmful exposure to microwave energy. It is important not to defeat or tamper with the safety interlocks.
- (b) Do not place any object between the oven front face and the door or allow soil or cleaner residue to accumulate on sealing surfaces.
- (c) Do not operate the oven if it is damaged. It is particularly important that the oven door close properly and that there is no damage to the:
 - (1) Door (bent),
 - (2) Hinges and latches (broken or loosened),
 - (3) Door seals and sealing surfaces.
- (d) The oven should not be adjusted or repaired by anyone except properly qualified service personnel.

Electrical Requirements

⚠ WARNING



Electrical Shock Hazard

Plug into a grounded 3 prong outlet.

Do not remove ground prong.

Do not use an adapter.

Do not use an extension cord.

Failure to follow these instructions can result in death, fire, or electrical shock.

Observe all governing codes and ordinances. A 120 Volt, 60 Hz, AC only, 15- or 20-amp fused electrical supply is required. (A time-delay fuse or circuit breaker is recommended.) It is recommended that a separate circuit serving only this appliance be provided.

GROUNDING INSTRUCTIONS

■ **For all cord connected appliances:**

The microwave oven must be grounded. In the event of an electrical short circuit, grounding reduces the risk of electric shock by providing an escape wire for the electric current. The microwave oven is equipped with a cord having a grounding wire with a grounding plug. The plug must be plugged into an outlet that is properly installed and grounded.

WARNING: Improper use of the grounding plug can result in a risk of electric shock. Consult a qualified electrician or serviceman if the grounding instructions are not completely understood, or if doubt exists as to whether the microwave oven is properly grounded.

Do not use an extension cord. If the power supply cord is too short, have a qualified electrician or serviceman install an outlet near the microwave oven.

■ **For a permanently connected appliance:**

This appliance must be connected to a grounded, metallic, permanent wiring system, or an equipment grounding conductor should be run with the circuit conductors and connected to the equipment grounding terminal or lead on the appliance.

SAVE THESE INSTRUCTIONS

This device complies with Part 18 of the FCC Rules.

PARTS AND FEATURES

This manual may cover several different models. The model you have purchased may have some or all of the features shown here. The appearance of your particular model may differ slightly from the illustrations in this manual.

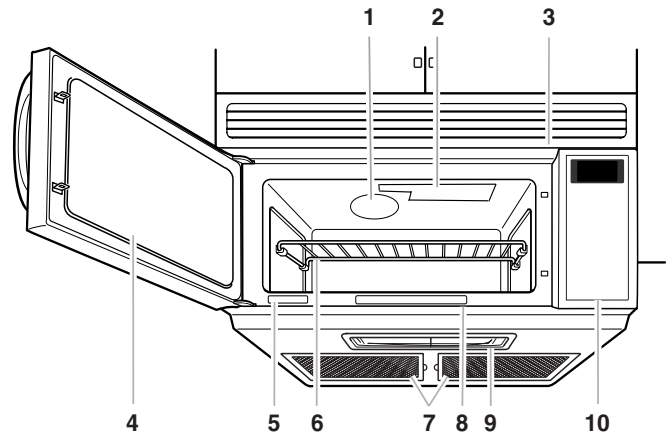

1. Microwave Inlet Cover

2. Microwave Oven Light

3. Vent Grille

4. Metal Shielded Window

5. Model and Serial Number Plate

6. Cooking Rack

7. Charcoal and Grease Filters
(shipped in oven cavity)

8. Cooking Guide Label

9. Cooktop Light

10. Control Panel

Parts and Features not shown
Turntable

Turntable

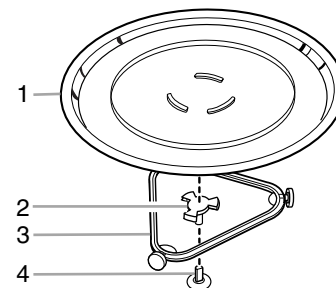

1. Turntable

2. Hub

3. Support

4. Shaft

The turntable can rotate in either direction to help cook food more evenly. Do not operate the oven without the turntable in place. See "Assistance or Service" to reorder any of the parts.

To Install:

1. Remove tape from the hub.
2. Place the support on the oven cavity bottom.
3. Place the turntable on the support.

Fit the raised, curved lines in the center of the turntable bottom between the three spokes of the hub. The rollers on the support should fit inside the turntable bottom ridge.

Turning Off the Turntable

The turntable can be turned off (except during an auto function). This is helpful when cooking with plates that are larger than the turntable or when cooking with two 10¼ in. (26 cm) plates that are side-by-side.

To Turn Off: Touch TURNTABLE ON/OFF. "TURNTABLE OFF" will appear in the display. The turntable will turn back on automatically when cooking is over or CANCEL•OFF is touched.

Cooking Rack

The cooking rack is ideal for two-level cooking. It provides extra cavity space for cooking two or more containers at the same time. Insert the rack securely into the rack supports on the side walls of the oven. See "Assistance or Service" section to reorder rack.

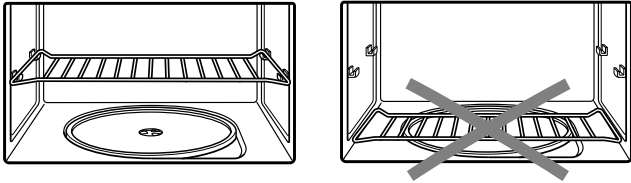

- Rack will become hot. Always use oven mitts or pot holders when handling.
- Do not allow the rack to touch the inside cavity walls, ceiling or floor.
- Do not use metal cookware, utensils, or a browning dish with the rack.
- Do not let food container on rack touch the top or sides of the oven.
- Do not place popcorn bags on rack.
- The rack is designed specifically for this oven. Do not use it in any other oven.
- Do not cook food directly on the rack. Always use a microwave-safe container.
- Use the rack only when cooking on two levels. Do not store it in the oven. Damage to the oven could result if someone accidentally turns on the oven.

MICROWAVE OVEN CONTROL

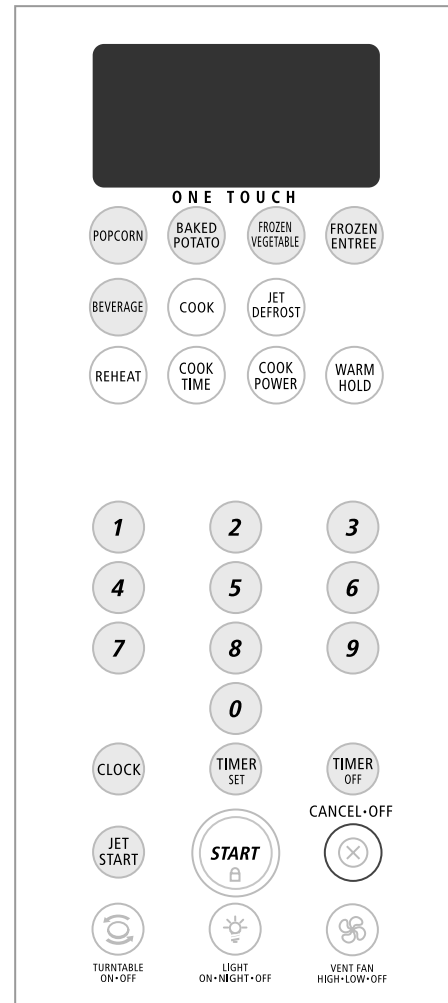

Display

When power is first supplied to the microwave oven, a ":" will blink on the display. Touch CANCEL•OFF to stop the blinking. Any other time a ":" blinks on the display, a power failure occurred. Touch CANCEL•OFF and reset the clock if needed.

When the microwave oven is in use, the display shows cooking power, quantities, weights and/or prompts.

If "RETRY" blinks on the display for 1 second, an invalid value was entered. Retry your entry.

When the microwave oven is not in use, the display shows the time of day or Timer countdown.

Progress Bar



The progress bar is a visual picture of the estimated running time of a cooking cycle. It will appear during Cook, JET DEFROST™ feature, Reheat and Sensor One Touch functions. The lines in each of the segments will light from left to right as the time nears the end. When all 12 lines (all 3 segments) are lit, the cooking cycle is completed.

Number Codes

The microwave oven is preset with shortcut number codes. A number code includes one or more of the following: cooking power, cook time and food quantity or weight. See the charts in the “Cooking” and/or “Reheating” sections for additional information.

Start

The START pad begins any function. If not touched within 5 seconds after touching a pad, “START?” will appear on the display as a reminder. If not touched within 1 minute after touching a pad, the display will return to the time of day mode and the programmed function will be canceled.

If cooking is interrupted, touching START will resume the preset cycle.

JET START™ Feature

The JET START™ control will start any function. If not touched within 5 seconds after touching a pad, “START?” will appear on the display as a reminder. If not touched within 5 minutes after touching a pad, the display will return to the time of day mode and the programmed function will be canceled.

If cooking is interrupted, touching the JET START™ control will resume the preset cycle.

The JET START™ control, touched by itself, will automatically start the microwave oven for a 30 second cook time at 100% cooking power.

The JET START™ control, touched while the microwave oven is operating in any cook function, will add 30 seconds of cook time at the cook power currently in use. Each touch of the JET START™ console pad will add 30 additional seconds of cook time.

Cancel•Off

The CANCEL•OFF pad stops most functions except for the Timer, Control Lock and Demo Mode.

The microwave oven will also turn off when the door is opened. Close the door and touch START to resume the cycle.

Clock

This is a 12-hour clock and does not show a.m. or p.m.

To Set:

The microwave oven and timer must be off.

1. Touch CLOCK.
2. Touch the number pads to set the time of day.
3. Touch CLOCK or START.

To Remove:

1. Touch CLOCK.
2. Touch 0.
3. Touch CLOCK.

The time will disappear and “:” will appear on the display.

Tones

Tones are audible signals, indicating the following:

One tone

- Valid entry (short tone)
- End of Timer countdown (long tone)

Two tones

- Reminder, repeat each minute after the end-of-cycle tones
- End of stage in multistage cooking
- Turn food during defrost cycle (short tones)
- Hidden feature has been entered or exited

Three tones

- Invalid entry

Four tones

- End-of-cycle

To Turn Off/On Valid Entry Tones: Touch and hold the number pad “1” for 5 seconds until 2 tones sound. Repeat to turn tones back on.

To Turn Off/On All Tones: Touch and hold the number pad “2” for 5 seconds until 2 tones sound. Repeat to turn tones back on.

Timer

The Timer can be set in minutes and seconds, up to 99 minutes 99 seconds and counts down the set time. The Timer does not start or stop the microwave oven.

When the Timer is in use, the microwave oven can also operate. To see the countdown for 5 seconds when the microwave oven is in use, touch TIMER SET.

To Set:

1. Touch TIMER SET.
If no action is taken after 1 minute, the display will return to the time of day mode.
2. Touch the number pads to set the length of time.
3. Touch TIMER SET or START.
If not touched within 5 seconds, "START?" will appear on the display. If not touched within 1 minute, the display will return to the time of day mode and the programmed function will be canceled.
When the set time ends, "END" will appear on the display and 1 tone will sound.
4. Touch TIMER OFF at any time to cancel the Timer.
The length of time can be changed during the countdown by repeating the above steps.

Child Lock

The Child Lock shuts down the control panel pads to prevent unintended use of the microwave oven.

When the control is locked, only the Vent Fan and Light pads will function.

To Lock/Unlock Control: The microwave oven and Timer must be off. Touch and hold START for 5 seconds until 2 tones sound and a lock icon appears on the display. Repeat to unlock and remove the lock icon from display.

Vent Fan

The vent fan has 2 speeds: high and low.

To protect the microwave oven, if the temperature from the range or cooktop below the microwave oven gets too hot, the vent fan will automatically turn on. It may stay on for up to 1 hour to cool the microwave oven. When this occurs, the Vent Fan pad will not function.

To Turn Vent Fan On/Off: Touch VENT FAN HIGH/LOW/OFF pad once for HIGH, twice for LOW or 3 times for OFF.

Cooktop Light

The cooktop light has 3 settings: on, night and off.

To Turn On/Night/Off: Touch LIGHT ON•NIGHT•OFF repeatedly to cycle through settings.

Demo Mode

The Demo Mode is ideal for learning how to use the microwave oven. When set, functions can be entered without actually turning on the magnetron. The microwave oven light will come on, the fan will run and, if on, the turntable will rotate.

To Turn On/Off: The microwave oven and Timer must be off. Touch and hold TIMER OFF for 5 seconds until 2 tones sound and "d" appears on the display. Repeat to turn off and remove "d" from the display.

MICROWAVE OVEN USE

A magnetron in the oven produces microwaves which reflect off the metal floor, walls and ceiling and pass through the turntable and appropriate cookware to the food. Microwaves are attracted to and absorbed by fat, sugar and water molecules in the food, causing them to move, producing friction and heat which cooks the food.

- Never lean on or allow children to swing on the oven door.
- Do not operate microwave oven when it is empty.
- Heated liquids can splash out during and after heating. Use of a wooden stir stick placed in the cup or bowl during heating may help to avoid this.
- The turntable must be in place and correct side up when oven is in use. Do not use if turntable is chipped or broken. See "Assistance or Service" section to reorder.
- Baby bottles and baby food jars should not be heated in the oven.
- Clothes, flowers, fruit, herbs, wood, gourds, paper, including brown paper bags and newspaper should not be dried in the oven.
- Do not use the microwave oven for canning, sterilizing or deep frying. The oven cannot maintain appropriate temperatures.
- Paraffin wax will not melt in the oven because it does not absorb microwaves.
- Use oven mitts or pot holders when removing containers from oven.
- Do not overcook potatoes. At the end of the recommended cook time, potatoes should be slightly firm. Let potatoes stand for 5 minutes. They will finish cooking while standing.
- Do not cook or reheat whole eggs inside the shell. Steam buildup in whole eggs may cause them to burst. Cover poached eggs and allow a standing time.

Food Characteristics

When microwave cooking, the amount, size and shape, starting temperature, composition and density of the food affect cooking results.

Amount of Food

The more food heated at once, the longer the cook time. Check for doneness and add small increments of time if necessary.

Size and Shape

Smaller pieces of food will cook more quickly than larger pieces and uniformly shaped foods cook more evenly than irregularly shaped food.

Starting Temperature

Room temperature foods will heat faster than refrigerated foods and refrigerated foods will heat faster than frozen foods.

Composition and Density

Foods high in fat and sugar will reach a higher temperature and heat faster than other foods. Heavy, dense foods, such as meat and potatoes, require a longer cook time than the same size of a light, porous food, such as cake.

Cooking Guidelines

Covering

Covering food helps retain moisture, shorten cook time and reduce spattering. Use the lid supplied with cookware. If a lid is not available, wax paper, paper towels or plastic wrap approved for microwave ovens may be used. Plastic wrap should be turned back at one corner to provide an opening to vent steam.

Stirring and Turning

Stirring and turning redistributes heat evenly to avoid overcooking the outer edges of food. Stir from outside to center. If possible, turn food over from bottom to top.

Arranging

If heating irregularly shaped or different sized foods, the thinner parts and smaller sizes should be arranged toward the center. If cooking several items of the same size and shape, place them in a ring pattern, leaving the center of the ring empty.

Piercing

Before heating, use a fork or small knife to pierce or prick foods that have a skin or membrane, such as potatoes, egg yolks, chicken livers, hot dogs, and sausage. Prick in several places to allow steam to vent.

Shielding

Use small, flat pieces of aluminum foil to shield the thin pieces of irregularly shaped foods, bones and foods such as chicken wings, leg tips and fish tail. See "Aluminum Foil and Metal" first.

Standing Time

Food will continue to cook by the natural conduction of heat even after the microwave cycle ends. The length of standing time depends on the volume and density of the food.

Cookware and Dinnerware

Cookware and dinnerware must fit on the turntable. Always use oven mitts or pot holders when handling because any dish may become hot from heat transferred from the food. Do not use cookware and dinnerware with gold or silver trim. Use the following chart as a guide, then test before using.

MATERIAL	RECOMMENDATIONS
Aluminum Foil, Metal	See "Aluminum Foil and Metal" section.
Browning Dish	Bottom must be at least $\frac{3}{16}$ in. (5 mm) above the turntable. Follow manufacturer's recommendations.
Ceramic Glass, Glass	Acceptable for use.

MATERIAL	RECOMMENDATIONS
China, Earthenware	Follow manufacturer's recommendations.
Melamine	Follow manufacturer's recommendations.
Paper Towels, Dinnerware, Napkins	Use non-recycled and those approved by the manufacturer for microwave oven use.
Plastic Wraps, Bags, Covers, Dinnerware, Containers	Use those approved by the manufacturer for microwave oven use.
Pottery and Clay	Follow manufacturer's recommendations.
Styrofoam*	Do not use in oven.
Straw, Wicker, Wooden Containers	Do not use in oven.
Wax Paper	Acceptable for use.

To Test Cookware or Dinnerware for Microwave Use:

- Put cookware or dinnerware in oven with 1 cup (250 mL) of water beside it.
- Cook at 100% cooking power for 1 minute.

Do not use cookware or dinnerware if it becomes hot and the water stays cool.

Aluminum Foil and Metal

Always use oven mitts or pot holders when removing dishes from the microwave oven.

Aluminum foil and some metal can be used in the oven. If not used properly, arcing (a blue flash of light) can occur and cause damage to the oven.

OK for Use

Racks and bakeware supplied with the oven, aluminum foil for shielding, and approved meat thermometers may be used with the following guidelines:

- Never allow aluminum foil or metal to touch the inside cavity walls, ceiling or floor.
- Always use the turntable.
- Never allow contact with another metal object during cooking.

Do Not Use

Metal cookware and bakeware, gold, silver, pewter, non-approved meat thermometers, skewers, twist ties, foil liners such as sandwich wrappers, staples and objects with gold or silver trim or a metallic glaze should not be used in the oven.

Cooking Power

Many recipes for microwave cooking specify which cooking power to use by percent, name or number. For example, 70%=7=Medium-High.

Use the following chart as a general guide for the suggested cooking power of specific foods.

PERCENT/ NAME	NUMBER	USE
100%, High (default setting)	10	Quick heating convenience foods and foods with high water content, such as soups, beverages and most vegetables.
90%	9	Cooking small tender pieces of meat, ground meat, poultry pieces and fish fillets. Heating cream soups.
80%	8	Heating rice, pasta or casseroles. Cooking and heating foods that need a cook power lower than high. For example, whole fish and meat loaf.
70%, Medium-High	7	Reheating a single serving of food.
60%	6	Cooking sensitive foods such as cheese and egg dishes, pudding and custards. Cooking non-stirrable casseroles, such as lasagna.
50%, Medium	5	Cooking ham, whole poultry and pot roasts. Simmering stews.
40%	4	Melting chocolate. Heating bread, rolls and pastries.
30%, Medium-Low, Defrost	3	Defrosting bread, fish, meats, poultry and precooked foods.
20%	2	Softening butter, cheese, and ice cream.
10%, Low	1	Taking chill out of fruit.

Cooking

To Use:

1. Touch COOK TIME.
Touch number pads to enter cooking time.
2. Touch COOK POWER.
Touch number pads to enter power level, if other than 100%.
3. Touch START.
The display will count down the cook time.
When the cycle ends, "END" will appear in the display, 4 end-of-cycle tones will sound, and then reminder tones will sound every minute.
4. Touch CANCEL•OFF or open the door to clear the display and/or stop reminder tones.
The cook time and power may be changed after touching START without interrupting cooking.

To Change Cook Time: Touch COOK TIME. The countdown will freeze for a few seconds. Enter the new cook time and touch START or wait a few seconds for the countdown to resume.

To Change Cook Power: Touch COOK POWER repeatedly to scroll through the cook power levels. Touch START.

Cooking in Stages

The microwave oven can be set to cook at different cooking powers for various lengths of time, up to 3 stages.

To Cook in Stages:

1. Touch COOK TIME.
2. Touch number pads to enter length of time to cook during the first stage.
3. Touch COOK POWER.
4. Touch the number pad(s) using the Cooking Power chart to set the cooking power for the 1st cycle.
5. Repeat steps 1-4 for the 2nd and 3rd cycles.
6. Touch START.
The display will count down each of the cook times. The numbers "1," "2" and "3" will appear on the display during their respective stages.
When the cycle ends, "END" will appear in the display, 4 end-of-cycle tones will sound, and then reminder tones will sound every minute.
7. Touch CANCEL•OFF or open the door to clear the display and/or stop reminder tones.

The cook time and cook power of the cycling stage can be changed after touching START without interrupting cooking.

To Change Cook Time: Touch COOK TIME. The countdown will freeze for a few seconds. Enter the new cook time and touch START or wait a few seconds for the countdown to resume.

To Change Cook Power: Touch COOK POWER repeatedly to scroll through the cook power levels. Touch START.

One Touch Cooking

Times and cooking power have been preset for specific microwavable foods. Use the following chart as a guide.

PRESET COOKING PAD	PAD TOUCH/ QUANTITY	INSTRUCTIONS
POPCORN	1 = 3.5 oz (99 g) 2 = 3.0 oz (85 g) 3 = 1.75 oz (50 g)	Pop only commercially packaged microwave popcorn. Pop only one bag at a time. If using microwave popcorn popper, follow manufacturer's instructions.
BAKED POTATO	1-4 (No. of potatoes)	Based on 10-13 oz (283-369 g) potato Before baking, pierce potato with fork several times. After baking, let stand for 5 minutes.
FROZEN VEGETABLE	1-4 cups (250 mL-1 L)	Remove from package. Place in microwavable container. Cover with plastic wrap and vent. Stir and let stand 2-3 minutes.
FROZEN ENTRÉE	1 = 10 oz (283 g) 2 = 20 oz (567 g)	Remove from package. Loosen cover on 3 sides.
BEVERAGE	1-2 (8 oz cups)	Do not cover.

To Use:

1. Touch appropriate One Touch pad (see chart, above).
2. Touch pad repeatedly to enter quantity (see chart, above).

The display will count down the cook time.

When the cycle ends, "End" will appear in the display, 4 end-of-cycle tones will sound, and then reminder tones will sound every minute.

To Change Cook Time: Touch COOK POWER repeatedly to scroll through "MORE," "LESS" or "NORML" time.

Preset Cooking

Times and cooking power have been preset for specific microwavable foods. Use the following chart as a guide.

FOOD	PAD	QUANTITY
Rice	1	.5-2 cups (125-500 mL)
Fresh Vegetables	2	1-4 cups (250 mL-1 L)
Canned Vegetables	3	1-4 cups (250 mL-1 L)

FOOD	PAD	QUANTITY
*Bacon	4	1-6 slices, average thickness
Instant Cereal	5	1-4 servings
French Toast, frozen	6	1-4 pieces

* Differences in the amount of fat, meat, thickness, and curing process affect results. Average is 16 slices per pound.

To Use Preset Cooking:

1. Touch COOK.
2. Touch number pad from chart
or
Touch COOK repeatedly to scroll through foods.
3. Touch number pads to enter quantity, except for Rice.
4. Touch START.
The display will count down the cook time.

When the cycle ends, "END" will appear in the display, 4 end-of-cycle tones will sound, and then reminder tones will sound every minute.
5. Touch CANCEL•OFF or open the door to clear the display and/or stop reminder tones.

To Change Cook Time: Touch COOK POWER repeatedly to scroll through "MORE," "LESS" or "NORML" time.

Reheating

Times and cooking power have been preset for reheating specific food types. Use the following chart as a guide.

FOOD	PAD	QUANTITY
Pizza	1	1-3 slices, 5 oz (142 g) each
Soup/Sauce	2	1-4 cups (250 mL-1 L)
Casserole	3	1-4 cups (250 mL-1 L)
Baked Goods	4	1-6 pieces, 2 oz (57 g) each
Dinner Plate	5	1 serving

To Use Reheat:

1. Touch REHEAT.
2. Touch number pads to select type of food from chart
or
Touch REHEAT repeatedly to scroll through foods.

3. Touch number pads to enter quantity.

4. Touch START.

The display will count down the reheat time.

When the cycle ends, "END" will appear in the display, 4 end-of-cycle tones will sound, and then reminder tones will sound every minute.

5. Touch CANCEL•OFF or open the door to clear the display and/or stop reminder tones.

To Change Cook Time: Touch COOK POWER repeatedly to scroll through "MORE," "LESS" or "NORML" time.

Defrosting

The JET DEFROST™ feature can be used or the microwave oven can be manually set to defrost.

- Food should be 0°F (-18°C) or colder at defrosting for optimal results.
- Unwrap foods and remove lids (from fruit juice) before defrosting.
- Shallow packages will defrost more quickly than deep blocks.
- Separate food pieces as soon as possible during or at the end-of-cycle for more even defrosting.
- Use small pieces of aluminum foil to shield parts of food such as chicken wings, leg tips and fish tails. See “Aluminum Foil and Metal” first.

The JET DEFROST™ system has 3 categories: Meat, Poultry and Fish. It should not be used for food left outside the freezer more than 20 minutes and frozen ready-made food. Use the following chart as a guide.

MEAT

<i>Beef:</i> ground, steaks, roast, stew	The narrow or fatty areas of irregular shaped cuts should be shielded with foil before defrosting.
<i>Lamb:</i> stew and chops	
<i>Pork:</i> chops, ribs, roasts, sausage	Do not defrost less than ¼ lb (113 g) or two 4 oz (113 g) patties. Place all meats in microwavable baking dish.

POULTRY

<i>Chicken:</i> whole and cut up	Place in microwavable baking dish, chicken breast-side up.
<i>Cornish hens</i>	
<i>Turkey:</i> breast	Remove giblets from whole chicken.

FISH

<i>Fillets, Steaks, Whole, Shellfish</i>	Place in microwavable baking dish.
--	------------------------------------

To use JET DEFROST™ system:

1. Touch the JET DEFROST pad.
2. Touch the number pad 1 for Meat, 2 for Poultry or 3 for Fish
or
Touch JET DEFROST pad repeatedly to scroll through foods.
3. Touch the number pads to enter the weight.
Meats and Poultry can be set from .2 to 6.6 lb (90 g to 3 kg).
Fish can be set from .2 to 4.4 lb (90 g to 2 kg).

4. Touch START.

The display will count down the defrost time.

About halfway through defrosting, “TURN” will appear on the display while the oven continues to operate. Open door, turn food, close door, then press START to resume.

When the cycle ends, “END” will appear in the display, 4 end-of-cycle tones will sound, and then reminder tones will sound every minute.

5. Touch CANCEL•OFF or open the door to clear the display and/or stop reminder tones.

To Change Cook Time: Touch COOK POWER repeatedly to scroll through “MORE,” “LESS” or “NORML” time.

To Defrost manually:

1. Touch COOK TIME.
2. Touch the number pads to set a length of time to defrost.
3. Touch COOK POWER.
4. Touch number pad 3.
5. Touch START.

The display will count down the defrost time.

When the cycle ends, “END” will appear in the display, 4 end-of-cycle tones will sound, and then reminder tones will sound every minute.

6. Touch CANCEL•OFF or open the door to clear the display and/or stop reminder tones.

Warm Hold

WARNING

Food Poisoning Hazard

Do not let food sit in oven more than one hour before or after cooking.

Doing so can result in food poisoning or sickness.

Hot cooked food can be kept warm in the microwave oven. Warm Hold can be used by itself or can be programmed to follow a cooking cycle. Opening the door during Warm Hold will cancel the function.

To Use:

Put hot cooked food in the oven. Cover plates of food and foods that were cooked covered. Pastries, pies, turnovers, etc. should remain uncovered.

1. Touch WARM HOLD.
2. Touch START.

“WARM” will appear on the display and the warm time will count down.

When the cycle ends, “END” will appear in the display, 4 end-of-cycle tones will sound, and then reminder tones will sound every minute.

3. Touch CANCEL•OFF or open the door to clear the display and/or stop reminder tones.

To set at end of cycle: Touch WARM HOLD while setting a cooking cycle before touching START, or during cooking.

MICROWAVE OVEN CARE

General Cleaning

IMPORTANT: Before cleaning, make sure all controls are off and the oven is cool. Always follow label instructions on cleaning products.

Soap, water and a soft cloth or sponge are suggested first unless otherwise noted.

GREASE FILTERS

Do not use ammonia or corrosive cleaning agents such as lye-based oven cleaners.

■ Hot water and mild detergent:

Soak filters, then scrub and swish to remove embedded dirt and grease. Rinse well and shake to dry.

■ Dishwasher:

Wash separately, not with dirty dishes, because food can be trapped in the filters.

OVEN CAVITY

Do not use soap-filled scouring pads, abrasive cleaners, steel-wool pads, gritty washcloths or some paper towels. Damage may occur.

The area where the oven door and frame touch when closed should be kept clean.

Average soil

■ Mild, nonabrasive soaps and detergents:

Rinse with clean water and dry with soft, lint-free cloth.

Heavy soil

■ Mild, nonabrasive soaps and detergents:

Heat 1 cup (250 mL) of water for 2 to 5 minutes in oven. Steam will soften soil. Rinse with clean water and dry with soft, lint-free cloth.

Odors

■ Lemon juice or vinegar:

Heat 1 cup (250 mL) of water with 1 tablespoon (15 mL) of either lemon juice or vinegar for 2 to 5 minutes in oven.

OVEN DOOR EXTERIOR

■ Glass cleaner and paper towels or nonabrasive plastic scrubbing pad:

Apply glass cleaner to soft cloth or sponge, not directly on panel.

TURNTABLE

Replace turntable immediately after cleaning. Do not operate the microwave oven without the turntable in place.

■ Mild cleanser and scouring pad

■ Dishwasher

Replacing Filters

The grease filters should be removed and cleaned at least once a month. The charcoal filters cannot be washed and should be replaced every six to twelve months. Do not operate the microwave oven without the filters in place. See "Assistance or Service" to reorder filters. See "General Cleaning" for cleaning instructions.

To Remove:

1. Unplug microwave oven or disconnect power.
2. Remove the grease filters by pushing up and sliding to the side. Pull tab down until the filter drops out.

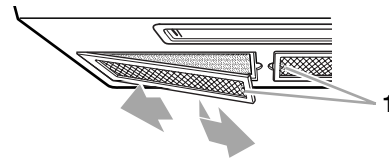

1. Tabs

3. Remove charcoal filters by pushing the back of each filter away from you until the front of the filter slides off the front lower lip. Swing the front of the filter down and slide out.

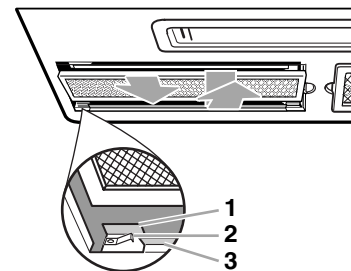

1. Upper lip
2. Spring
3. Lower lip

To Replace:

1. Replace charcoal filters by positioning the filter at the back of the opening and resting it on the springs. While pushing the filter into the springs, position the front of filter between the front upper and lower lips.
2. Replace grease filters by inserting one end into the frame. Swing other side up and slide into position.
3. Plug in microwave oven or reconnect power.

Replacing Cooktop Light

The cooktop light is a candelabra base 30-watt bulb. See “Assistance or Service” section to reorder.

To Replace:

1. Unplug microwave oven or disconnect power.
2. Remove the bulb cover mounting screw.

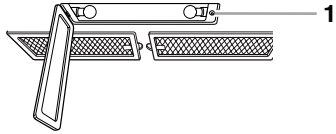

1. Mounting screw

3. Replace light. Close bulb cover. Replace mounting screw.
4. Plug in microwave oven or reconnect power.

Replacing Microwave Oven Light

The microwave oven light is a candelabra base 30-watt bulb. It will automatically come on when the door is opened and when the microwave oven is operating. See “Assistance or Service” section to reorder.

To Replace:

1. Unplug microwave oven or disconnect power.
2. Remove the 2 outer vent grille mounting screws located above the cover.

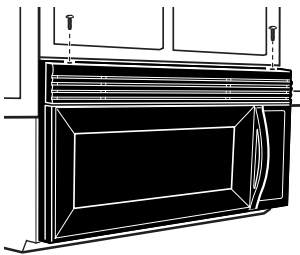

3. Tip the grille forward, then lift out to remove.

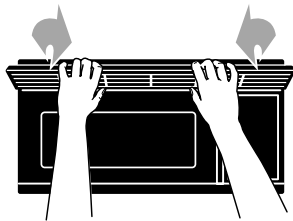

4. Lift up the bulb cover.

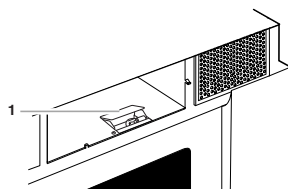

1. Bulb cover

5. Replace light. Close bulb cover.

6. Reattach vent grille. Replace the mounting screws.

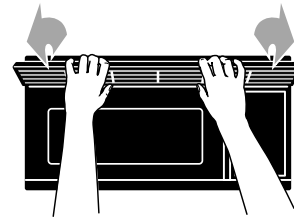

7. Plug in microwave oven or reconnect power.

TROUBLESHOOTING

Try the solutions suggested here first in order to avoid the cost of an unnecessary service call.

Nothing will operate

- **Has a household fuse been blown or has the circuit breaker been tripped?**
Replace the fuse or reset the circuit.
- **Is the appliance wired properly?**
See Installation Instructions.

Oven will not operate

- **Is the door completely closed?**
Firmly close door.
- **Is a spacer (on some models) attached to the inside of the door?**
Remove spacer, then firmly close door.
- **Is the electronic oven control set correctly?**
See “Microwave Oven Control” section.
- **On some models, is the Child Lock set?**
See “Child Lock” section.
- **Is the magnetron working properly?**
Try to heat 1 cup (250 mL) of cold water for 2 minutes at 100% cooking power. If water does not heat, call for service. See “Assistance or Service” section.

Oven makes humming noise

- This is normal and occurs when the power supply switches the magnetron on and off.

Oven door looks wavy

- This is normal and will not affect performance.

Turntable will not operate

- **Is the turntable properly in place?**
Make sure turntable is correct-side up and is sitting securely on the turntable support.
- **Is the turntable support operating properly?**
Remove turntable. Remove and replace turntable support. Replace turntable. Place 1 cup (250 mL) of water on the turntable, then restart oven. If it still is not working, call for service. See “Assistance or Service” section. Do not operate the oven without turntable and turntable support working properly.

Turntable rotates both directions

- This is normal and depends on motor rotation at beginning of cycle.

Display shows messages

- **Is the display showing “:”?**
There has been a power failure or the clock time has been turned off. See “Display” section to clear display. See “Clock” section to reset the clock or to turn it on.
- **Is the display showing a letter followed by a number?**
See “Display” section to clear. If it reappears, call for service. See “Assistance or Service” section.

Display shows time countdown, but is not operating

- **Is the Timer in use?**
See “Timer” section.
- **On some models, is the Demo Mode in use?**
See “Demo Mode” section.

Tones are not sounding

- **Are tones turned off?**
See “Tones” section.

Steam is coming from the vent grille

- Some steam is normal.

Fan running slower than usual

- **Has the oven has been stored in a cold area?**
The fan will run slower until the oven warms up to normal room temperature.

Cooking times seem too long

- **Is the cooking power set properly?**
See “Cooking Power” section.
- **Are large amounts of food being heated?**
Larger amounts of food need longer cooking times.
- **Is the incoming voltage less than specified in “Microwave Oven Safety”?**
Have a qualified electrician check the electrical system in the home.

Radio or TV Interference

- **Is the microwave oven plugged into the same outlet?**
Try a different outlet.
- **Is the radio or TV receiver near the microwave oven?**
Move the receiver away from the microwave oven, or adjust the radio or TV antenna.
- **Are the microwave oven door and sealing surfaces clean?**
Make sure these areas are clean.

ASSISTANCE OR SERVICE

Before calling for assistance or service, please check “Troubleshooting.” It may save you the cost of a service call. If you still need help, follow the instructions below.

When calling, please know the purchase date and the complete model and serial number of your appliance. This information will help us to better respond to your request.

If you need replacement parts

If you need to order replacement parts, we recommend that you only use FSP® replacement parts. FSP® replacement parts will fit right and work right because they are made with the same precision used to build every new WHIRLPOOL® appliance.

To locate FSP® replacement parts in your area, call our Customer Interaction Center telephone number or your nearest Whirlpool designated service center.

In the U.S.A.

Call the Whirlpool Customer Interaction Center toll free: **1-800-253-1301**.

Our consultants provide assistance with:

- Features and specifications on our full line of appliances.
- Installation information.
- Use and maintenance procedures.
- Accessory and repair parts sales.
- Specialized customer assistance (Spanish speaking, hearing impaired, limited vision, etc.).
- Referrals to local dealers, repair parts distributors, and service companies. Whirlpool designated service technicians are trained to fulfill the product warranty and provide after-warranty service, anywhere in the United States.

To locate the Whirlpool designated service company in your area, you can also look in your telephone directory Yellow Pages.

For further assistance

If you need further assistance, you can write to Whirlpool Corporation with any questions or concerns at:

Whirlpool Brand Home Appliances
Customer Interaction Center
553 Benson Road
Benton Harbor, MI 49022-2692

Please include a daytime phone number in your correspondence.

Replacement Parts

Turntable
Part No. 4393751

Turntable Support
Part No. 4393752

Turntable Rollers
Part No. 4393753

Turntable Hub
Part No. 4393754

Cooking Rack
Part No. 8183813

Grease Filters
Part No. 8169758

Charcoal Filters
Part No. 4393791

Cooktop and Microwave Light Bulb
Part No. 4393681

WHIRLPOOL® MICROWAVE HOOD COMBINATION WARRANTY

ONE-YEAR FULL WARRANTY

For one year from the date of purchase, when this appliance is operated and maintained according to instructions attached to or furnished with the product, Whirlpool Corporation will pay for FSP® replacement parts and repair labor to correct defects in materials or workmanship. Service must be provided by a Whirlpool designated service company.

SECOND THROUGH FIFTH YEAR LIMITED WARRANTY ON MAGNETRON TUBE

In the second through fifth years from the date of purchase, when this appliance is operated and maintained according to instructions attached to or furnished with the product, Whirlpool Corporation will pay for FSP® replacement parts for the microwave magnetron tube if defective in materials or workmanship.

Whirlpool Corporation will not pay for:

1. Service calls to correct the installation of your appliance, to instruct you how to use your appliance, to replace house fuses or correct house wiring, or to replace owner-accessible light bulbs and filters.
 2. Repairs when your appliance is used in other than normal, single-family household use.
 3. Pickup and delivery. Your appliance is designed to be repaired in the home.
 4. Damage resulting from accident, alteration, misuse, abuse, fire, flood, improper installation, acts of God or use of products not approved by Whirlpool Corporation.
 5. Repairs to parts or systems resulting from unauthorized modifications made to the appliance.
 6. Replacement parts or repair labor costs for units operated outside the United States.
 7. Any labor costs during the limited warranty period.
-

WHIRLPOOL CORPORATION SHALL NOT BE LIABLE FOR INCIDENTAL OR CONSEQUENTIAL DAMAGES.

Some states do not allow the exclusion or limitation of incidental or consequential damages, so this exclusion or limitation may not apply to you. This warranty gives you specific legal rights and you may also have other rights which may vary from state to state.

Outside the 50 United States, this warranty does not apply. Contact your authorized Whirlpool dealer to determine if another warranty applies.

If you need service, first see the "Troubleshooting" section of this book. After checking "Troubleshooting," additional help can be found by checking the "Assistance or Service" section or by calling the Whirlpool Customer Interaction Center, **1-800-253-1301** (toll-free), from anywhere in the U.S.A.

5/00

Keep this book and your sales slip together for future reference. You must provide proof of purchase or installation date for in-warranty service.

Write down the following information about your appliance to better help you obtain assistance or service if you ever need it. You will need to know your complete model number and serial number. You can find this information on the model and serial number label/plate, located on your appliance as shown in the "Parts and Features" section.

Dealer name _____
Address _____
Phone number _____
Model number _____
Serial number _____
Purchase date _____

